

# **IP Office 8.1**

## **Product Description**



© 2012 AVAYA All Rights Reserved.

#### Notice

While reasonable efforts were made to ensure that the information in this document was complete and accurate at the time of printing, Avaya Inc. can assume no liability for any errors. Changes and corrections to the information in this document may be incorporated in future releases.

#### Documentation Disclaimer

Avaya Inc. is not responsible for any modifications, additions, or deletions to the original published version of this documentation unless such modifications, additions, or deletions were performed by Avaya.

#### Link Disclaimer

Avaya Inc. is not responsible for the contents or reliability of any linked Web sites referenced elsewhere within this Documentation, and Avaya does not necessarily endorse the products, services, or information described or offered within them. We cannot guarantee that these links will work all of the time and we have no control over the availability of the linked pages.

#### License

USE OR INSTALLATION OF THE PRODUCT INDICATES THE END USER'S ACCEPTANCE OF THE TERMS SET FORTH HEREIN AND THE GENERAL LICENSE TERMS AVAILABLE ON THE AVAYA WEBSITE AT <http://support.avaya.com/LicenseInfo/> ("GENERAL LICENSE TERMS"). IF YOU DO NOT WISH TO BE BOUND BY THESE TERMS, YOU MUST RETURN THE PRODUCT(S) TO THE POINT OF PURCHASE WITHIN TEN (10) DAYS OF DELIVERY FOR A REFUND OR CREDIT.

Avaya grants End User a license within the scope of the license types described below. The applicable number of licenses and units of capacity for which the license is granted will be one (1), unless a different number of licenses or units of capacity is specified in the Documentation or other materials available to End User. "Designated Processor" means a single stand-alone computing device. "Server" means a Designated Processor that hosts a software application to be accessed by multiple users. "Software" means the computer programs in object code, originally licensed by Avaya and ultimately utilized by End User, whether as stand-alone Products or pre-installed on Hardware. "Hardware" means the standard hardware Products, originally sold by Avaya and ultimately utilized by End User.

License Type(s): Designated System(s) License (DS).

End User may install and use each copy of the Software on only one Designated Processor, unless a different number of Designated Processors is indicated in the Documentation or other materials available to End User. Avaya may require the Designated Processor(s) to be identified by type, serial number, feature key, location or other specific designation, or to be provided by End User to Avaya through electronic means established by Avaya specifically for this purpose.

#### Copyright

Except where expressly stated otherwise, the Product is protected by copyright and other laws respecting proprietary rights. Unauthorized reproduction, transfer, and or use can be a criminal, as well as a civil, offense under the applicable law.

#### Third-Party Components

Certain software programs or portions thereof included in the Product may contain software distributed under third party agreements ("Third Party Components"), which may contain terms that expand or limit rights to use certain portions of the Product ("Third Party Terms"). Information identifying Third Party Components and the Third Party Terms that apply to them is available on Avaya's web site at: <http://support.avaya.com/ThirdPartyLicense/>

#### Avaya Fraud Intervention

If you suspect that you are being victimized by toll fraud and you need technical assistance or support, call Technical Service Center Toll Fraud Intervention Hotline at +1-800-643-2353 for the United States and Canada. Suspected security vulnerabilities with Avaya Products should be reported to Avaya by sending mail to: [securityalerts@avaya.com](mailto:securityalerts@avaya.com).

For additional support telephone numbers, see the Avaya Support web site (<http://www.avaya.com/support>).

#### Trademarks

Avaya and the Avaya logo are registered trademarks of Avaya Inc. in the United States of America and other jurisdictions.

Unless otherwise provided in this document, marks identified by "®," "™" and "SM" are registered marks, trademarks and service marks, respectively, of Avaya Inc. All other trademarks are the property of their respective owners.

#### Documentation information

For the most current versions of documentation, go to the Avaya Support web site (<http://www.avaya.com/support>) or the IP Office Knowledge Base (<http://marketingtools.avaya.com/knowledgebase/>).

#### Avaya Support

Avaya provides a telephone number for you to use to report problems or to ask questions about your contact center. The support telephone number is 1 800 242 2121 in the United States. For additional support telephone numbers, see the Avaya Web site: <http://www.avaya.com/support>.

# Contents

## 1. Introduction

Avaya IP Office.....	6
What's New in IP Office Release 8.1 .....	9
Voice Communication Solution Features.....	10
Data Communication Solution Features .....	11
Applications Platform Features.....	12
Management Tools .....	13
Scalable Platform.....	14
Telephone Options.....	14
Application and Feature Licensing.....	14
Country Availability.....	14

## 2. IP Office Basic Edition PARTNER® Mode

Hardware .....	20
Telephones .....	22
System Administration.....	29
System Features.....	32

## 3. IP Office Basic Edition Norstar® Mode

Hardware .....	51
Telephones .....	53
System Administration.....	57
System Features.....	60

## 4. IP Office Server Edition

Mid-market Overview.....	77
IP Office Solution Overview.....	77
IP Office Key Components.....	81
IP Office Deployment Options.....	81
IP Office Scalability .....	82
IP Office Resiliency.....	82
IP Office Centralized Licensing.....	84
IP Office Centralized Management.....	86
Documentation, Training, and Localization.....	87
Serviceability.....	89

## 5. IP Office 500 Platform

IP Office 500 Control Unit.....	91
IP500 Base Cards.....	93
IP500 Trunk Cards.....	98
External Expansion Modules.....	102

## 6. Telephones

9600 Series IP Telephones.....	109
B100 Conference Telephones .....	125
9504 and 9508 Digital Telephones.....	131
1600 Series IP Telephones and 1400 Series Digital Telephones.....	134
T3 Telephones.....	142
Wireless Phone Solutions.....	146
Other Phones Supported.....	187
Analog Telephones.....	216
Headsets .....	222

Summary .....	223
---------------	-----

## 7. Features and Call Handling

Basic Call Handling.....	228
Advanced Call Handling.....	232
Key and Lamp Operation.....	238
Outbound Call Handling Features.....	240
Forwarding.....	242
Avaya Telephone Features.....	244
Inbound Call Handling.....	248
Contact Center Features.....	250
Miscellaneous Features.....	251
System Short Codes.....	252

## 8. IP Telephony

Gateways, Gatekeepers and H.323 - Technology Overview .....	256
SIP - Session Initiation Protocol.....	256
IP Telephony Features.....	257
SIP Trunks.....	259
SIP Endpoint Support.....	261
IP Office 8.1 Interoperability.....	266
Remote Phone Support.....	269
Avaya Session Border Controller for Enterprise.....	272
VoIP FAQ .....	272

## 9. Public and Private Voice Networks

Private Circuit Switched Voice Networking.....	278
Public Voice Networking .....	279
E1R2 Channel Associated Signaling.....	281
Session Initiation Protocol (SIP).....	281
Packet Based Voice Networking.....	284
Supplementary Services within IP Networks.....	285
Multi-Site Networking (Small Community Networking).....	286
Internetworking with Other Avaya Products.....	289
Common Networking Features.....	290

## 10. Data Networking Services

LAN/WAN Services.....	293
Internet Access .....	293
Remote Access Features.....	294
LAN to LAN Routing.....	294
SSL/VPN Remote Access.....	295
Data Networking Features.....	295

## 11. Unified Communications Module

## 12. User Call Control Applications

one-X Portal for IP Office.....	304
IP Office Video Softphone.....	318
Flare Communicator.....	325

## 13. Receptionist

SoftConsole Options.....	335
SoftConsole Administration.....	336
SoftConsole PC Requirements.....	337

## 14. Computer Telephony Integration

CTI with IP Office.....	339	<b>20. IP Office Support Services and Automated On-Boarding</b>	
TAPILink Lite (1st Party TAPI Support).....	340	Avaya Global Services.....	430
TAPILink Pro (3rd Party TAPI Support).....	340	On-Boarding Automation.....	431
Support for Developers.....	340	<b>21. Technical Specifications</b>	
TAPI Functions Supported by IP Office.....	341	Interfaces .....	437
<b>15. Messaging</b>		Protocols .....	437
IP Office Essential Edition - Embedded Voicemail... 348		<b>22. Licenses</b>	
IP Office Preferred Edition - Voicemail Pro..... 350		<b>23. Appendix</b>	
IP Office Preferred Edition - Voicemail Pro Resilience and Backup..... 354			
Interaction of Voicemail with Email Systems..... 357			
Unified Messaging Service (UMS)..... 358			
Fax Messages..... 361			
Text-to-Speech Email Reading (Microsoft Exchange only)..... 362			
Networked Messaging..... 363			
Auto Attendant..... 364			
Personal Numbering..... 365			
Accessing Database Information within Call Flows (IVR) .....	366		
Using Text To Speech (TTS) Facilities within a Call Flow .....	367		
Visual Basic (VB) Scripting..... 368			
Extended Personal Greetings..... 369			
Hunt Group Broadcast Messages..... 370			
Personal Distribution Lists..... 370			
Cascaded Out-Calling..... 371			
Campaign Manager..... 372			
Call Recording..... 373			
Call Screening..... 374			
IP Office ContactStore..... 375			
Centralized Messaging with Avaya Communication Manager .....	377		
Voicemail Feature Comparison..... 378			
<b>16. Mobility</b>			
one-X Mobile Preferred for IP Office..... 383			
On-Site Mobility..... 385			
External Mobility..... 387			
3rd Party Mobility Solutions for Use with IP Office... 390			
<b>17. Audio Conferencing</b>			
IP Office Preferred Edition Meet-Me Conferencing Solution .....	394		
IP Office Conferencing Capacity..... 395			
IP Office Standard Conferencing Features..... 396			
<b>18. The Contact Center</b>			
Customer Call Reporter..... 398			
<b>19. Management Utilities</b>			
IP Office Web Manager..... 414			
IP Office Simplified Manager..... 420			
IP Office Monitor..... 422			
Simple Network Management Protocol (SNMP)..... 423			
System Status Application..... 424			
Data Migration Manager..... 425			

# Chapter 1.

# Introduction

# 1. Introduction

**This document is not a contractual document. The specification of the Avaya IP Office family is subject to change without notice. Not all components and features documented are available in all territories; refer to your Avaya representative for further details. This document should be read in conjunction with any issued technical bulletins and/or product offer announcements.**

---

## Avaya IP Office

---

Simple, Powerful Communications for Small Businesses.

### What is IP Office?

IP Office is a versatile communications solution that combines the reliability and ease of a traditional telephony system with the applications and advantages of an IP telephony solution. This converged communications solution can help businesses reduce costs, increase productivity, and improve customer service.

### How can I use it in my business?

Avaya IP Office unifies your communications, providing your employees with a solution that lets them handle all their business communications on the device of their choice: their laptop, mobile phone, office telephone or home telephone; using wired, wireless or broadband connections.

### What are my choices?

Successful companies are always looking for new ways to do more with less – keeping their business flexible, innovative and competitive without driving up operating costs and capital expenses. Avaya IP Office is the right choice for any small business today – whether you have 5, 25, 250 or 1000 employees... just getting started or already established have a single location or multiple locations across the globe...

With IP Office you can tailor the solution to your user needs (e.g. Teleworker, Mobile Worker, Customer Service Agent, etc.). Whether you have 5 employees, 25, 250 or more, IP Office is the right choice.

### IP Office: Three key things to know

All small and medium size businesses are seeking ways to reduce costs and improve the way it operates. Like every business, you're looking to keep all your customers, add new ones and grow at the pace that's right for you. Avaya understands this. With over one hundred years of experience as a leader in communications, we know that the right solution for your business is one that helps you increase profitability, improve productivity and gain competitive advantages.

### Serving Customers Effectively with Unified Communications

Your office telephone, cell phone, e-mail, texting, instant messaging and even your home telephone are all essential to the way you work today. Unlike other solutions, Avaya IP Office uses built-in intelligence to simplify your use of wired, wireless and Internet communications. Instead of keeping your communications separate, Avaya IP Office brings them together so you can easily turn a home or mobile phone into an office extension, collaborate with dozens of customers or staff members on a conference call and get detailed reports that show how well your company is responding to customers. With rich functionality, IP Office naturally creates new ways of thinking about the role communications can play in your business.

### See what Avaya can do for you

You need a communications system – every business does. To find one that's right for your business, start with Avaya. With solutions like IP Office, we're revolutionizing how small and medium size businesses communicate. Now is the time to see what an Avaya solution can do for your business.

### Reduce monthly costs. Now.

IP Office will help you lower the cost of communications, with capabilities like conferencing, making calls over a managed Internet service (Voice over IP) and the "all-in-one" benefits of a converged communications system.

### Leave the office. Be accessible.

With easy, flexible options for call/message forwarding and one-number reachability, IP Office keeps everyone in touch. Get the freedom to go where you want and never miss important business calls.

### Serve better. Sell more.

IP Office can give you a customer sales and service center designed for your needs and your budget – with all the routing and reporting capabilities you need. Deliver the personal service that builds sales and loyalty.

### Get connected

Talk to your Avaya Business Partner. Discuss where you want communications to add value to your business. Learn about the different service and support options that are available. See why thousands of growing businesses rely on the innovative Avaya IP Office solution.

## **The right choice for you and your business**

How we communicate is a personal choice – it has to match the needs of your business. And your needs change depending on whether your employees are working in the office, at home, or on the road. That's why when you choose IP Office you can also choose from a whole range of communication tools and applications designed to boost productivity. Choose a basic telephone or one with all the "bells and whistles." Connect our IP telephones directly to your office LAN – you can even take them home and get all the features you have at the office. With Avaya IP Office, a PC or laptop and an internet connection you can turn the screen of your PC into a telephone. And our wireless solutions make it easier to roam the office. With all of our IP Office capabilities, our goal is to make your communications simple and cost-effective. Let your Avaya BusinessPartner put together a selection of tools and applications that's right for you.

## **Fine-tuning performance**

How many calls are you handling an hour, a day? What are your peak calling periods? How many calls typically turn into sales? The Avaya IP Office reporting capabilities can help you measure and manage your availability and response to customers.

## **Day-to-day administration**

Once your system is up and running you will benefit from the graphical administration tools that simplify day-to-day tasks, such as updating directories and moving telephone extensions.

## **Getting started**

Is your communications network ready for IP Office? We'll make sure. Avaya has created assessment and automated configuration tools to make sure that when your system is installed it's ready to meet your needs starting Day One.

## **Keeping ongoing management simple**

Concerned about needing extra resources to administer a system as powerful as IP Office? There's no need for worry. IP Office comes with a whole set of graphical tools to keep ongoing management simple.

## **Does my current phone system give my business what it needs?**

If it is based on old technology, probably not. Your competitors will react faster and appear more professional with the latest in communications software. IP Office delivers the capabilities that allow you to keep up with or overtake the competition.

## **Do I need to understand the technology to implement it?**

No. IP Office is designed specifically to give you more functionality without making more demands on your resources. Rely on your certified Avaya BusinessPartner for support before, during and after your purchase. We'll take care of you so you don't have to worry.

## **Do I need to spend a lot?**

Not at all. You have choices based on your budget needs. Easy leasing or financing plans not only make this affordable; they help you quickly cut monthly expenses immediately. And you only have to buy/lease what you need, when you need it.

## **Is IP technology established and reliable?**

Yes. With over 170,000 systems and 6 Million users worldwide Avaya IP Office has the track record businesses like yours can rely on. Customers like you are saving money and boosting productivity and many are managing IP Office themselves.

## **I have old systems but am adding an office. Should I consider newer technology?**

Not only would this be a way for you to experience the rich functionality of the latest communications applications, but we may be able to network with your existing equipment, as well as provide a gradual migration plan for your other locations.

## **I have a Nortel BCM or Nortel Norstar system. Can I keep my existing telephones?**

Yes. IP Office supports the majority of Nortel BCM and Norstar telephones. You can save between 40 to 60% of your original investment by keeping your existing telephones. Whether you want to add additional telephones or replace older telephones, IP Office supports nearly every kind.

## **How quickly can I get up and running?**

Just say "when" – an authorized Avaya BusinessPartner can tailor a solution to your needs and your budget. By saving you money and helping you grow, IP Office repays your investment and lets you reallocate resources to other business priorities.

## **Lowering long distance costs**

Routing telephone calls over the Internet (Voice over IP or VoIP for short) – is growing in popularity. Particularly in the case of international calls, VoIP generates significant savings. If your company is already linking multiple offices using high-speed data circuits, the VoIP capabilities in IP Office make it possible to route voice calls over the existing infrastructure, providing another way to lower costs and leverage your investment. However you do it, the VoIP capabilities of IP Office are a way to put money back in your pocket.

### **Eliminating conferencing fees**

Collaborate with customers, partners, suppliers and remote employees. IP Office includes a 128 party audio conference bridge (64 max in one conference) to keep people working together and travel costs down. With Avaya IP Office, your organization can have its own private, secure conference bridge and eliminate expensive fees to third party conference providers.

### **Maximizing productivity**

When employees can't get to the office (because of storms, personal issues or other reasons) IP Office allows them to work as at home (or any other location) as productively as though they were in the office.

### **And keep in mind...**

IP Office delivers a whole range of capabilities. Only you can put a number on the value that many of these capabilities will have for your business.

Examples:

- Having calls automatically routed to a cell telephone or other location, so important customers can get through to the right person in real-time
- Being able to operate as a 24/7 business, without a 24/7 staff
- Using your communications to quickly identify when your top customers call

### **How IP Office is benefiting businesses today**

- **More room for sales**  
With IP Office, a leading provider of commercial food service equipment now handles 50% more calls per day, without extra staff and without sacrificing the personal service it knows is the key to sales
- **At the head of the class**  
By relying on IP Office to connect nearly 50 buildings, a public school system saved thousands of dollars on inter-office calls and simplified communications
- **Lowering global costs**  
By using IP Office to hold teleconferences and make phone calls across the IP network, a strategic consulting firm is saving up to \$30,000 per year

### **IP Office can grow as your business grows to meet your needs**

Capacities: 2-384 extensions on a single location; up to 192 analog lines; 192/240 T1/E1 lines; 128 VoIP trunk lines; up to 1000 users across 32 locations.

### **Call handling and messaging**

Get 24-hour support for callers/customers without a 24-hour staff. IP Office has a range of messaging, auto attendant and Interactive Voice Response (IVR) capabilities. Integrate messaging and advanced call handling into your customer service operations. Handle voice mail and email in a single mailbox.

### **Communication with customers**

Set up a formal or informal customer service center. Integrate your customer data base into your call handling. Manage the quality of your customer interactions.

### **Work anywhere**

Give your employees all the communications capabilities they have at the office whether they are working from home, a hotel or a remote office.

### **Collaborate with customers, vendors and remote staff**

Don't pay any more fees to outside conferencing service providers. Use IP Office built in audio conferencing that is easy to set up and use while saving you money

### **Secure converged communications**

Use IP Office as a secure router with a built-in firewall/VPN. Route voice calls over a managed Internet service (VoIP) and pocket the savings. Simple administration Windows-based, graphical tools cut the time and expense of administration.



---

## What's New in IP Office Release 8.1

---

The features listed below are available worldwide unless otherwise specified. Not all of the features in IP Office Release 8.1 are supported on all platforms and phones - please see each feature's description for more information.

### IP Office Control Unit Support

IP Office Release 8.1 is supported on the IP500, IP500 V2, and IP Office for Linux.

### New Hardware Components

- IP Office Server Edition – Primary/Secondary Servers
  - HP DL 360 G7
  - HP DL120 G7
- IP Office Server Edition – Expansion Server
  - HP DL120 G7

### IP Office Licensing Changes

- New Licensees for Server Edition
- Remote worker seats included with Essential edition is increased from 2 seats to 4 seats.
- User Profile licenses (Teleworker, Office Worker, Mobile User, Power User) running on a pre 8.0 Essential Edition will be valid if the system is upgraded to 8.1 with an upgrade license or if the system is upgraded during the entitlement period without an upgrade license. Only IP Office 500v2 systems have entitlement period.
- Behavior not changing but listed for completeness:
  - New R8.1 systems will require Preferred Edition licenses in order for the User Profile licenses to be valid.
- The automatic trial licenses available during the entitlement period with release 8.0.16 and associated alarms will be removed and will not be available.

### End-point additions

- Flare Communicator for Windows
- Flare Communicator for iPad

### IP Office Enhancements

- SIP Trunks
- one-X ® Mobile Preferred for IP Office enhancements
- Web Manager Enhancement supporting Upgrade, Back-up & restore
- Changeable RTP ports
- Contact Center Enhancements
  - CCR DDI Report
  - Scheduled Reports for the current day
  - CDR Answered event renamed
  - Changes to duration of events for CDR
  - Wallboard – Manual Layout and Font Sizing
  - Wallboard – Bookmark and Auto-Login
  - Wallboard – Statistics values on Leader Board
  - Wallboard – Configurable update interval
  - Wallboard – Monitor table
  - CCR support for 96x1 Phones
  - CCR Client Browser on Windows 7

- VoiceMail Pro Password length configuration
- Security Documentation
- Avaya Audio Branding change
- one-X ® Portal for IP Office websockets
- Debug enhancement – Logger stamp support
- SSL/VPN Remote Access
- On-Boarding automation to support the introduction of the new Avaya IP Office Support Services

#### **IP Office Demo Kits**

- Power Demo Kit
- IP Office Anywhere

---

## **Voice Communication Solution Features**

---

IP Office offers a comprehensive list of features and benefits for the small or mid-size business, including:

- **Full PBX Features**  
Caller ID, Call Forwarding, Conference Calling, Voice Messaging and more.
- **Trunk Interfaces**  
A variety of network trunk interfaces, including E1, T1, PRI, ISDN, SIP, analog loop start and analog ground start for comprehensive network connectivity. Not all trunk types are available in all territories, please check for local availability.
- **Extensions**  
Support for a range of extensions, from 2 to 384 that provide sophisticated voice performance for new and growing businesses.
- **Telephones**  
A variety of telephones including analog, digital and IP hard and softphones (wired and wireless) that provide the appropriate desktop or device telephone for every need.
- **Advanced Call Routing**  
Incoming calls are directed to the best available person or messaging service, according to the company's unique criteria.
- **Alternate Call Routing**  
Ensures reliable handling of calls by selecting from analog, digital or VoIP trunks.
- **QSIG Networking**  
Standards-based multi-site networking to interoperate with other PABXs (licensed feature).
- **Integrated H.323 and SIP Gatekeeper and Gateway for Converged Communications**  
The IP Office acts as an IP telephony server with Quality of Service (QoS) support through DiffServ for call routing.
- **SIP Trunking**  
SIP trunking to Internet Telephony Service Providers. IP Office allows users with non-SIP telephones to make and receive SIP trunk calls.

---

## Data Communication Solution Features

---

For offices with basic data networking needs, IP Office can provide a complete data communications and networking solution:

- **Internet Access**

Firewall protected leased line or dial-up connectivity via PRI, T1 or WAN port: high-speed dialed access, direct leased line connections for high usage and Web site hosting, integral security, and efficient access to information and a larger business presence via the Web.

- **Routing**

Integral Static or Dynamic (RIP I/II) routing for both Internet and Branch-to-Branch solutions.

- **Security**

NAT (Network Address Translation) and built in firewall to protect your internal network and IPSec support allows secure VPN data transmission across public IP Networks using 3DES encryption.

- **DHCP**

Automatic IP address allocation for local and remotely attached PC's and other devices, including IP telephones.

- **LAN Switching**

The IP Office 500 V2 offers 2 switched Layer 3 Ethernet ports.

- **LDAP Client Support**

For standards based directory synchronization with Avaya one-X™ Portal for IP Office and Phone Manager.

---

## Applications Platform Features

---

IP Office provides big business benefits and enhanced productivity for small and mid-size businesses with a full complement of sophisticated applications.

IP Office provides a number of free applications (e.g., Microsoft TAPI service). These applications can be upgraded to provide enhanced functionality through the purchase of license keys. The complete list of applications are:

- **Receptionist/Operator SoftConsole**

A graphical User Interface (GUI) for attendants on their PC desktop for call handling. Works with a telephone and is an easy way to learn and use sophisticated tools in a comfortable environment.

- **Avaya one-X™ Portal for IP Office**

A powerful client/server web application that allows the user to control and manage phone calls from a web browser with the standard LDAP protocol for connectivity to external directories.

- **Open CTI interfaces**

IP Office has a built in TAPI server that integrates easily with popular contact management applications such as Outlook. Sophisticated custom applications can be rapidly developed and deployed with our full software development kit.

- **Voicemail**

Callers can always be answered with a personal voicemail greeting before a message is taken and message notification set. Messages can be shared (forwarded) with colleagues and retrieved by any telephone capable of tone dialing. When used with Avaya one-X™ Portal for IP Office, the PC can be used to control message playback.

- **Integrated Voicemail to Email Presentation**

Voice messages can be copied into email messages and delivered into the email system. IP Office uses SMTP or MAPI to deliver a copy of the voice message.

- **Unified Messaging (UMS)**

The Unified Messaging Service within Preferred Edition provides a higher level of integration to synchronize both voicemail and email inboxes.

- **Auto-Attendant**

Simplify service for administrators with this easy-to-use feature with the ability to construct customized automated services allowing callers to efficiently navigate the system, and reach the right person, without the assistance of an operator. Available with Preferred Edition and with Essential Edition.

- **Interactive Voice Response (IVR) and Text to Speech**

Create automated customized systems allowing callers to interact with business information, for example, reading email, account enquiry systems, automated ordering systems, ticket purchasing systems, PIN checking, remote time sheet management, etc. Enhance these systems by using Text To Speech to read information back to callers. Available with Advanced Edition.

- **Queue Manager and Campaign Manager**

Powerful voice and IVR applications for the Contact Center that facilitate agent and traffic management for better productivity and customer service.

- **Customer Call Reporter (CCR)**

Available with Advanced Edition and combined with the built-in Automatic Call Distribution functionality of IP Office, CCR enables a small business to track and measure customer service and agent productivity levels.

- CCR delivers:
  - Simple/Intuitive Reporting
  - Browser/Thin Client Architecture
  - Single Server Efficiency (with Preferred Edition)
- Target Segment: Small Business < 30 agents
  - Can support up to 150 agents
  - 30 supervisors
  - One administrator

---

## Management Tools

---

Avaya IP Office is easily managed with its management options.

IP Office Release 8.0 introduced the Web Manager. Web Manager is a new browser-based management tool designed to simplify the installation and maintenance process by providing an intuitive and user-friendly management tool that runs on most standard browsers. The new IP Office Web Manager eliminates the need to have Windows operating system as it can run on any device that supports standard browsers. In Release 8.0 and up, IP Office Web Manager supports the following Editions of IP Office:

- Basic Edition A-Law
- Basic Edition Mu-Law
- Basic Edition PARTNER Mode
- Basic Edition Norstar Mode (PBX, KTS)

IP Office manager is a Windows based PC software application. It can be used from the LAN, remote on the WAN, or connected via the built-in RAS using a TA or a modem to manage any IP Office edition.

The System Status application is a useful diagnostic tool that provides enhanced details about equipment and resources in the IP Office system. This includes indication of alarms and details of current calls in progress for local or remote diagnostics.

---

## Scalable Platform

---

The IP Office 500 V2 offers a modular, flexible chassis which with capacity for up to 16 analog trunks or 16 ISDN BRI trunks (32 channels) or 8 digital PRI trunks (up to 192 T1 channels or 240 E1 channels) using internal daughter cards. Up to 12 Expansion Modules may be added to provide a combination of up to 384 analog, digital or IP extensions, with additional analog trunks through external Analog 16 modules. Features include up to 148 optional voice compression channels, 2 independently switched LAN ports and built-in Embedded Voicemail.

---

## Telephone Options

---

IP Office supports multiple telephone solutions, giving the small and mid-size businesses maximum flexibility to choose according to their current and future needs.

- **IP Telephones**

IP Office's integral H.323 server supports Avaya 1600 and 5600 Series IP telephones, selected Avaya 9600 Series IP telephones, Avaya T3 Series IP telephones, Avaya 3600 Series wireless VoIP telephones and the IP Office Video Softphone.

- **Digital Telephones**

IP500 digital station 8 cards and Combination Cards plus IP Office digital station 16 or 30 Expansion Modules support the Avaya 9500, 1400 and 5400 Series of digital telephones and Avaya T3 Series telephones, plus selected 2400 and 4400 Series telephones. The new TCM8 digital extension card as well as the DS16A and DS30A digital expansion module support BCM / Norstar, T7000 Series telephones and other telephones and button modules.

- **ETR Telephones**

IP500 V2 ETR 6 cards support the Avaya ETR telephones as used on PARTNER ACS systems (Essential Edition – PARTNER Mode only).

- **Analog Telephones**

IP500 Phone 2, Phone 8 and Combination Cards plus IP Office Phone 16 or 30 Expansion Modules support standard analog telephones, faxes and modems, with support for calling line identification and message waiting indication where these services are provided.

- **Wireless Telephones**

Avaya DECT R4 base stations can be added to support the Avaya DECT R4 3720 and 3725 telephones. The IP Office digital station interfaces support the Avaya 3810 telephone. The Avaya 3600 Series wireless VoIP telephones are also supported. With the new hardware modules TCM8, DS16A, and DS30A Nortel digital Mobility solutions are also supported.

- **Third Party SIP Endpoints**

IP Office's integrated SIP Server supports third-party SIP endpoints such as, desktop telephones, softphones and conferencing speakerphones.

For a complete overview over of supported telephones please refer to the [Telephones](#)<sup>[107]</sup> section of this Product Description.

---

## Application and Feature Licensing

---

Some IP Office applications and features require a license key. Each license key is derived from the feature being enabled combined with the serial number of the Feature Key installed with the IP Office system.

IP500 and IP500 V2 systems use a mandatory Feature Key installed with every system.

Licenses are supplied in two forms; time limited trial licenses and indefinite licenses. Trial licenses allow applications to run in fully functional form for 60 days (from the date of license generation), after which time they cannot be used until upgraded at cost to the full license but can be ordered at any time during the product ownership.

For further details of the IP Office licenses, including Trial Licenses, refer to the [Licenses](#)<sup>[44]</sup> section.

---

## Country Availability

---

IP Office is available from distribution partners in the following countries. Please refer to your country price list for the availability of individual items.

<b>Americas</b>	<b>EMEA</b>	<b>APAC</b>
-----------------	-------------	-------------

<ul style="list-style-type: none"> <li>• Argentina</li> <li>• Brazil</li> <li>• Canada</li> <li>• Chile</li> <li>• Colombia</li> <li>• Dominican Republic</li> <li>• Ecuador</li> <li>• Guatemala</li> <li>• Honduras</li> <li>• Jamaica</li> <li>• Mexico</li> <li>• Panama</li> <li>• Peru</li> <li>• Puerto Rico</li> <li>• Trinidad &amp; Tobago</li> <li>• United States</li> <li>• Venezuela</li> </ul>	<ul style="list-style-type: none"> <li>• Austria</li> <li>• Bahrain</li> <li>• Belgium</li> <li>• Bulgaria</li> <li>• Cyprus</li> <li>• Czech Republic</li> <li>• Denmark</li> <li>• Egypt</li> <li>• Estonia</li> <li>• Finland</li> <li>• France</li> <li>• Germany</li> <li>• Greece</li> <li>• Hungary</li> <li>• Iceland</li> <li>• Ireland</li> <li>• Israel</li> <li>• Italy</li> <li>• Kuwait</li> <li>• Latvia</li> <li>• Liechtenstein</li> <li>• Lithuania</li> </ul>	<ul style="list-style-type: none"> <li>• Luxembourg</li> <li>• Malta</li> <li>• Morocco</li> <li>• Netherlands</li> <li>• Norway</li> <li>• Oman</li> <li>• Pakistan</li> <li>• Poland</li> <li>• Portugal</li> <li>• Romania</li> <li>• Russian Federation</li> <li>• Saudi Arabia</li> <li>• Slovak Republic</li> <li>• Slovenia</li> <li>• South Africa</li> <li>• Spain</li> <li>• Sweden</li> <li>• Switzerland</li> <li>• Turkey</li> <li>• UAE</li> <li>• United Kingdom</li> </ul>	<ul style="list-style-type: none"> <li>• Australia</li> <li>• China</li> <li>• Hong Kong</li> <li>• India</li> <li>• Malaysia</li> <li>• New Zealand</li> <li>• Phillipines</li> <li>• Singapore</li> <li>• Sri Lanka</li> <li>• Taiwan</li> <li>• Thailand</li> <li>• Vietnam</li> </ul>
---	--	--	---





# **Chapter 2.**

# **IP Office Basic Edition**

# **PARTNER® Mode**

## 2. IP Office Basic Edition PARTNER® Mode

The IP Office Basic Edition Partner Mode continues the evolution of communications systems for small businesses.

PARTNER Mode is designed to work directly out of the box without any programming or administration, allowing users to immediately make and place calls via analog trunks.

PARTNER Mode provides the end user a similar desktop experience as the PARTNER ACS: e.g. 2 dedicated intercom buttons, key system functionality, Caller ID, etc. This helps minimize training requirements and provides the end user with the same comfort level they have come to expect with the PARTNER ACS system.

PARTNER Mode provides enhanced features such as Visual Voice, Remote Call Forwarding, 64-party Conferencing, SIP Trunking, Full PRI/T1 and more.

PARTNER Mode provides the same 2-digit extension numbering plan as PARTNER ACS (default), and now supports a 3-digit flexible numbering plan (extensions 100 – 599).

PARTNER Mode supports all current and "Euro" versions of PARTNER ACS telephones, the 1400 Series digital telephones, the current 3920 and 3910 wireless products, as well as most analog devices (fax, wireless headsets, analog telephones). The original MLS Series telephones and older wireless telephones are not supported.

PARTNER Mode also supports a new line of Avaya digital telephones – the 9500 Series telephones, and supports the Nortel T-Series and M-Series digital telephones.

PARTNER Mode includes Embedded Voicemail; providing a 2-port Automated Attendant (upgradeable to 6-ports) and voice mail coverage activated for all telephones. The Embedded Voicemail offers a variable number of hours of storage:

- 2-ports = 15 hours of storage
- 4-ports = 20 hours of storage
- 6-ports = 25 hours of storage

### System Capacities

PARTNER Mode supports larger telephone and trunk capacity as follows (may not be attained simultaneously):

#### 100 Telephones:

- Up to 100 digital telephones (1400 Series, 9500 Series, T-series and M-Series telephones)
- Up to 100 analog telephones
- Up to 18 PARTNER ETR telephones (additional non ETR telephones can be added total to reach system capacity)

#### 64 Trunks:

- Up to 32 analog CO lines
- 1 PRI/T1 (24 lines)
- Up to 20 SIP lines
- can support up to 72 trunks, but not simultaneously

### IP Office Basic Edition Mu-Law

When the IP500 V2 containing a IP Office Mu-Law SD card is first started, it will boot-up as "Basic Edition", which has the same look and feel as PARTNER Mode, supporting out of the box operations, two intercom buttons, key system functionality, voice mailboxes on all telephones, TUI programming support, etc. "Basic Edition" makes starting and using the system quick and easy.

Users who need full IP Office Essential Edition functionality can apply the Essential edition license and the use Manager to change mode from "Basic Edition" to "Essential Edition". Once the system reboots, it re-starts as "Essential Edition" which is the way that IP Office Essential Edition works, looks and feels in Release 7.0.

## System Programming

System programming is accomplished in two ways:

- **Telephone User Interface** (TUI) from extension 10 or extension 11; and uses the same administration codes as the PARTNER ACS system.
- **Graphical User Interface** (GUI) – PARTNER Mode provides a "Simplified Manager" mode in the IP Office Manager software; allowing you to program the system in less than 30 minutes.

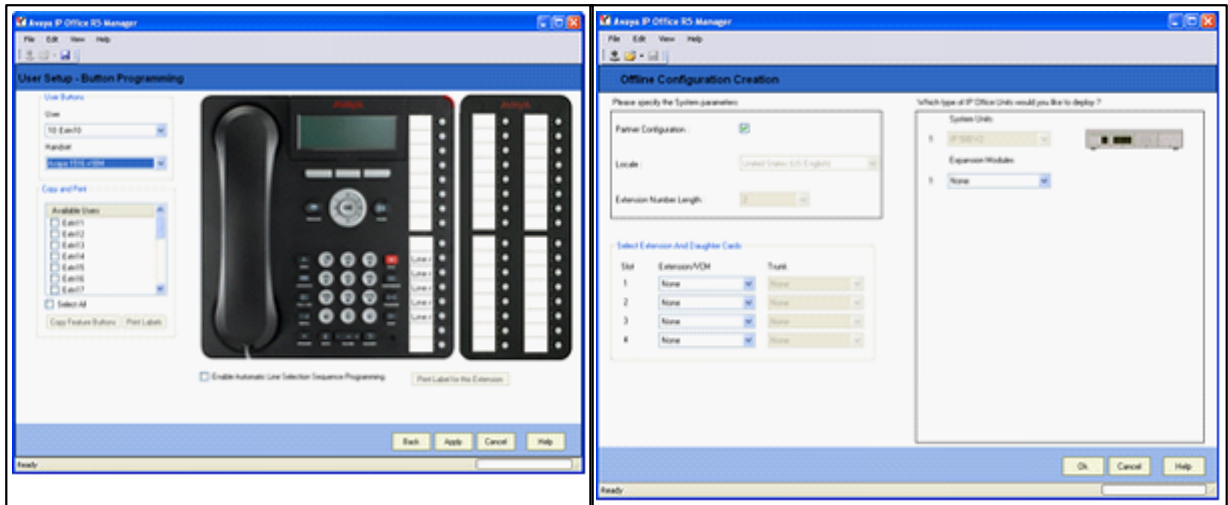

# Hardware

## Control Unit

PARTNER Mode software runs on the IP500 V2 control unit. A PARTNER Mode SD card or IP Office Mu-Law SD card is required and is installed in the rear of the control unit, providing operating software, Feature Key, Licenses and directs the system to boot up in PARTNER mode or Quick Mode. An optional SD card may be installed in the optional SD card slot, providing redundant backup and system upgrade capabilities.

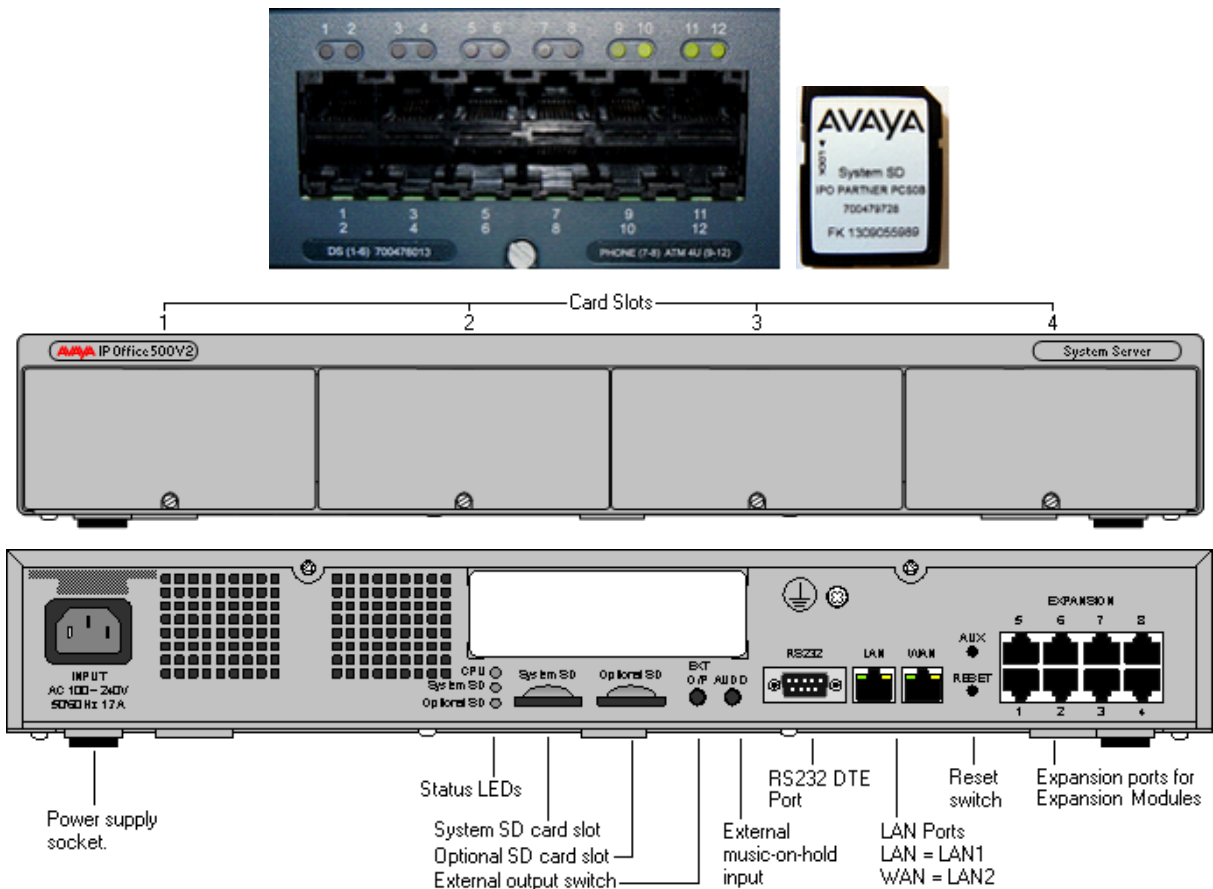

The front of the IP500 V2 Control Unit has 4 expansion bays, which supports the following system modules:

- **Combination Card** – Analog Trunks (Max 2 per system)  
The Combination Card provides 6 digital station (DS) ports (Ports 1-6); 2 analog station ports (Ports 7-8); 4 CO Line ports (Ports 9-12) and 10 Voice Compression Channels.
- **ETR6 Card** (Max 3 per system)  
The ETR6 Card provides 6 ETR (PARTNER ACS telephone) station ports (Ports 1-6); and supports (1) of the following optional trunk cards: ATM4 or PRI/T1. When an ATM4 is added, ports 7-8 become Power Failure Transfer ports, and ports 9-12 provide 4 additional CO Line Ports. Compatible only with PARTNER Mode and Mu-Law SD cards with Basic Edition, in North America market only.
- **DS8 Card** (Max 3 per system)  
The DS8 Card provides eight digital station ports (Ports 1-8); and supports (1) of the following optional trunk cards: ATM4 or PRI/T1. When an ATM4 is added, ports 9-12 provide 4 additional CO Line Ports. This card supports only the 1400 and 9500 Series telephones.
- **TCM8 Card** (Max 4 per system)  
The TCM8 Card provides eight digital station ports (Ports 1-8); and supports (1) of the following optional trunk cards: ATM4 or PRI/T1. When an ATM4 is added, ports 9-12 provide 4 additional CO Line Ports. This card supports only Norstar® T-Series and M-Series telephones.
- **Phone 2** (Max 4 per system)  
The Phone 2 module provides two additional analog station ports and supports one of the following optional trunk cards: ATM4 or PRI/T1.
- **Phone 8** (Max 4 per system)  
The Phone 8 module provides eight additional analog station ports and supports one of the following optional trunk cards: ATM4 or PRI/T1.

## Expansion Modules

PARTNER Mode supports following expansion modules:

- **DS16** – provides additional 16 digital station ports (1400 and 9500 Series telephones only)
- **DS16A** – provides additional 16 digital station ports (Norstar T-Series and M-Series telephones only)
- **ATM16 (limit 1 per system)** – provides additional 16 analog CO lines
- **Phone 16** – provides additional 16 analog stations
- **Phone 30** – provides additional 30 analog stations
- **DS30** – provides additional 30 digital station ports (1400 and 9500 Series telephones only)
- **DS30A** – provides additional 30 digital station ports (Norstar T-Series and M-Series telephones only)

## Trunk Cards

PARTNER Mode supports the following trunk cards, which are mounted on any ETR6, DS8, TCM8, Phone 2 or Phone 8 base card:

- **ATM4** – provides four analog CO line ports. Supports Caller ID
- **PRI/T1** – supports full PRI or T1. Limit 1 PRI/T1 card per system



---

# Telephones

---

PARTNER Mode supports the following telephones:

- [1400 Series digital telephones](#) [22]
- [9500 Series digital telephones](#) [23]
- [Norstar T-Series and M-Series digital telephones](#) [24]
- [PARTNER ACS telephones](#) [25]
- [PARTNER ACS "Euro" telephones](#) [26]
- [Wireless telephones](#) [27]
- [Analog "POTS" telephones](#) [28]

---

## 1400 Series telephones

The following 1400 Series telephones are supported.

- 1416 Display Telephones
- 1408 Display Telephones
- 1403 Display Telephone
- DBM32 Button Module



### Programmable Buttons

As well as the usual dialing keys, Avaya 1400 digital telephones have dedicated function buttons like Mute, Volume, Hold, Conference and Transfer. In addition to these, there are keys that can be programmed with a range of selected special functions. These keys can be used for calling other extensions on the system (Direct Station Select or DSS keys), or can be used for options from speed dialing numbers to controlling features such as Do Not Disturb. Many features use an indicator to show whether a feature is enabled.

Button programming is done through the TUI or Simplified Manager as part of the system configuration.

## 9500 Series telephones

The following 9500 Series telephones are supported.

- 9504 Display Telephone
- 9508 Display Telephone
- BM12 Button Module



9504



9508

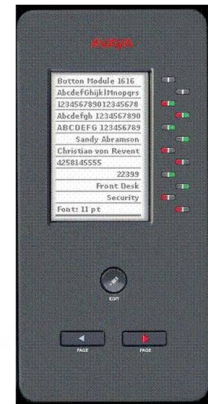

BM12

### Programmable Buttons

The Avaya 9500 Series telephones are "paper label free," providing programmable labels in the display. The 9504 has four buttons (with Red & Green LED's) and has two "pages" providing a total of 12 programmable buttons. The 9508 has eight buttons (with Red and Green LED's) and has two "pages" providing a total of 24 programmable buttons.

As well as the usual dialing keys, Avaya 9500 digital telephones have dedicated function buttons like Mute, Volume, Speaker, Headset, Call Logs and Contacts. In addition to these, there are keys that can be programmed with a range of selected special functions. These keys can be used for calling other extensions on the system (Direct Station Select or DSS keys), or can be used for options from speed dialing numbers to controlling features such as Do Not Disturb. Many features use an indicator to show whether a feature is enabled.

Button programming is done through the TUI or Simplified Manager as part of the system configuration.

---

## Norstar T-Series and M-Series telephones

The following Norstar telephones are supported on PARTNER Mode:

- T-Series Telephones: T7316E, T7208, T7100, T7000 and the T24KIM (not shown)



- M-Series Telephones: M7324, M7310 and the CAP/KLM Button Module





---

## PARTNER ACS telephones

The following PARTNER ACS telephones are supported on PARTNER Mode:

- 6 Button Display Telephone\*
- 18 Button Display Telephone\*
- 34 Button Display Telephone (up to 4 per system, 2 per ETR card)\*

\* = Supported, but no longer sold new



### Not Supported:

- Call Assist-48 (CA-48) Adjunct

### Default Button Features:

When connected to PARTNER Mode, the top row of buttons on the 18D and 34D telephones come pre-programmed with the following features:

- Last Number
- Conference Drop
- Voicemail Access
- Recall

---

## PARTNER ACS "Euro" telephones

The following PARTNER ACS "Euro" telephones are supported on PARTNER Mode:

- 6 Button non-Display Telephone
- 18 Button non-Display Telephone
- 18 Button Display Telephone
- 34 Button Display Telephone (up to 4 per system)



### Not supported:

- Call Assist-24 (CA-24) Adjunct

### Default Button Features:

When connected to the PARTNER Mode, the top row of buttons on the 18D and 34D telephones come pre-programmed with the following features:

- Last Number
- Conference Drop
- Voicemail Access
- Recall

**Note:** PARTNER ACS telephones are only available in the North America region, and work only with PARTNER Mode and Mu-Law SD cards running in Basic Edition.

---

## Wireless telephones

### 3920 Wireless



### T7406E Wireless



### Digital Mobility 7400 Wireless



**Note 1:** The 3910 Wireless telephone is discontinued, but it is still supported.

**Note 2:** PARTNER ACS telephones are only available in the North America region, and work only with PARTNER Mode and Mu-Law SD cards running in Basic Edition.

---

## Analog "POTS" telephones

The system supports a wide variety of industry standard analog telephones and devices, for example: fax machines, credit card readers; wireless headsets, cordless telephones.

Analog devices are connected to the system:

- To one of the analog ports on the Combination Card
- Via a Phone 2 or Phone 8 Module
- To an ETR station port (directly or bridged with a PARTNER ETR telephone)

The major features work the same, regardless how they are connected: e.g. Hold, Conference, Transfer, Call Waiting, Message Waiting, Incoming Caller ID.

Analog telephones have access to all dial-code features familiar to PARTNER users: e.g. Call pickup, Line pickup, Call Forwarding activation/deactivation, etc.

Analog telephones connected to a phone module or Combination Card default to intercom dial tone. To place an outgoing call, the user will dial 9. Analog telephones connected to an ETR module follows programmed Automatic Line Selection.

# System Administration

The PARTNER Mode and IP Office Basic Edition Mu-Law can be programmed in the following ways:

- Telephone User Interface (TUI) from extension 10 or extension 11; and uses the same [administration codes](#) as the PARTNER ACS system. Button Programming Features use the same codes as the PARTNER ACS system.

TUI programming is an alternate way to do System Administration and Programming on the PARTNER Mode. It is based on the PARTNER ACS TUI, but with improvements.

Using TUI System Administration on ETR, 1400 Series, 9500 Series and Norstar sets, the buttons under the display become soft-keys which are used to navigate and change the administration items. There are also shortcut codes which enable the administrator to jump to particular administration items.

Centralized Programming is similar to System Administration, but it is used to administer buttons and other options for any phone in the system.

Individual Programming continues to be supported, allowing the phone user to program buttons on their sets.

- Graphical User Interface (GUI) – PARTNER Mode can be administered using the IP Office Web Manager. IP Office Web Manager is a new browser-based management tool designed to simplify the installation and maintenance process by providing an intuitive and user-friendly management tool that runs on most standard browsers. The new IP Office Web Manager eliminates the need to have windows operating system as it can run on any device that supports standard browsers.



Web Manager main screen

For off line configuration, Upgrades, back-up and restore it is recommended that Manager continues to be used.

"Simplified Manager" is a PC GUI application inherent to the IP Office Manager application. Although system administration can be completed via either the TUI or GUI method; some advanced features such as SIP and PRI/E1 administration require the Manager application.

When you execute Manager, the program searches for any IP500 V2 units running PARTNER Mode on your network and will automatically connect using the default login and password. You are then presented with a "Simplified Manager" Screen:

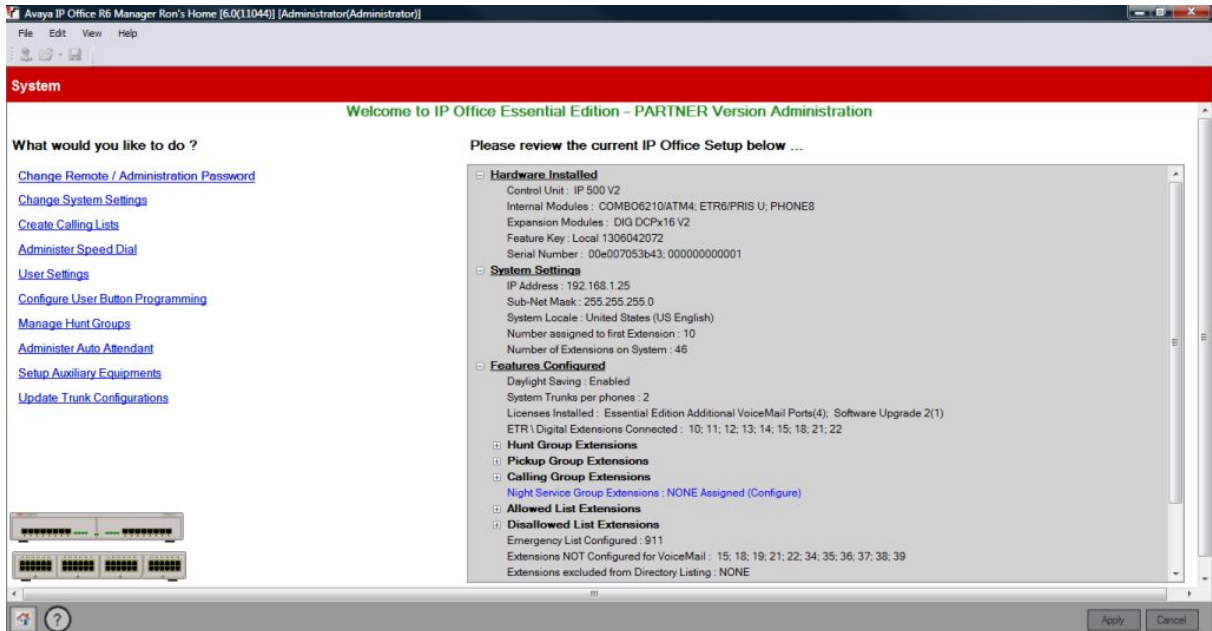

By using the system hyperlinks, you are able to quickly and easily administer the PARTNER Mode system in a short time. Further details can be found in the IP Office Norstar PARTNER Manager documentation guide posted on the Avaya Support website.

## Application Programming Interface (TAPI)

Application Programming Interface (TAPI) allows new and existing server-based applications from Avaya's Developer Connection (DevConnect) program to work with and enhance the operation of the system. The current requirement is to support a screen pop type application called "Pickup IP" which is also supported on IP Office.

The TAPI API only supports 1<sup>st</sup> Party TAPI applications.

## System Programming Procedures

Code	Feature	Code	Feature
#101	System Date	#321	VMS Cover Rings
#103	System Time	#322	Remote Call Forwarding
#104	Number of Lines	#323	Personalized Station Ringing
#105	Transfer Return Rings	#399	Copy Settings
#107	Recall Timer Duration	#401	Outgoing Call Restriction
#109	Outside Conference Denial	#402	Toll Call Prefix
#119	Ring on Transfer	#403	System Password
#123	Backup Programming—Automatic	#405	Disallowed List Assignments
#124	Backup Programming—Manual	#406	Emergency Phone Number List
#125	Restore Programming	#407	Allowed Phone Number Lists
#126	Automatic Daylight/Standard Times	#408	Allowed List Assignments
#127	Hold Reminder Tone	#409	Forced Account Code List
#128	Network Time Synchronization	#501	Pickup Group Extensions
#203	Hold Disconnect Time	#502	Calling Group Extensions
#205	Direct Extension Dial Lines	#503	Night Service Button
#206	Group Call Distribution	#504	Night Service Group Extensions
#208	Line Coverage Extension	#505	Hunt Group Extensions
#301	Line Assignment	#506	VMS Hunt Delay
#303	Display Language	#507	VMS Hunt Schedule
#304	Automatic Extension Privacy	#601	Fax Machine Extensions
#305	Abbreviated Ringing	#602	Music-On-Hold
#306	Transfer Return Extension	#603	Hotline
#307	Forced Account Code Entry	#604	Doorphone Extension 1
#308	Distinctive Ring	#605	Doorphone Extension 2
#309	Intercom Dial Tone	#606	Doorphone Alert Extensions
#310	Automatic VMS Cover	#610	SMDR Output Format
#311	External Hotline	#612	Contact Closure Group
#316	Call Waiting	#613	Contact Closure Operation Type
#317	Caller ID Log Answered Calls	#617	Loudspeaker Paging Line
#318	Caller ID Call Log Line Association	#728	System Reset—Programming Saved
#320	Call Coverage Rings	#730	Remote Administration Password

## Centralized Telephone Programming

Extensions 10 and 11 can program other extensions on the system from their telephones.

---

## System Features

---

The system provides the majority of the feature set that is ideal for businesses. A listing of the built-in features is detailed below. Feature descriptions can be found on the following pages. TUI Feature Programming Codes (if applicable) are also provided.

<a href="#">911 Emergency Dialing</a>	<a href="#">Direct Line Pickup Features</a>	<a href="#">PBX Mode</a>
<a href="#">Abbreviated Ringing</a>	<a href="#">Display</a>	<a href="#">Personal Line Termination</a>
<a href="#">Absent Text</a>	<a href="#">Display Language</a>	<a href="#">Personalized Station Ringing</a>
<a href="#">Absent Text Message Inspect</a>	<a href="#">Display SD Card Feature Key ID</a>	<a href="#">POT Support</a>
<a href="#">Account Codes</a>	<a href="#">Display System IP Address</a>	<a href="#">Privacy</a>
<a href="#">Allowed/Disallowed Lists</a>	<a href="#">Display System Release</a>	<a href="#">Recall</a>
<a href="#">Application Programming Interface (TAPI)</a>	<a href="#">Distinctive / Differentiated Ring</a>	<a href="#">Redialing Features</a>
<a href="#">Attendant/Operator Positions</a>	<a href="#">Do Not Disturb (Send All Calls)</a>	<a href="#">Remote Call Forwarding / Mobile Twinning</a>
<a href="#">Auto Attendants - Emergency Greeting</a>	<a href="#">Do Not Disturb Override</a>	<a href="#">Remote Access to Modem</a>
<a href="#">Auto Attendants - Multiple</a>	<a href="#">Doorphones (max of 2)</a>	<a href="#">Ringing Line Preference</a>
<a href="#">Automatic Callback</a>	<a href="#">Emergency Phone Number List</a>	<a href="#">Ring on Transfer</a>
<a href="#">Automatic Daylight Savings Time</a>	<a href="#">External Hotline</a>	<a href="#">SD Card Startup / Shut Down via TUI</a>
<a href="#">Automatic Extension Privacy</a>	<a href="#">Extension Hunt Groups</a>	<a href="#">SMDR</a>
<a href="#">Auto Dialing</a>	<a href="#">Extension Name Display</a>	<a href="#">Speed Dial Features</a>
<a href="#">Automatic Line Selection</a>	<a href="#">Fax Machine Extensions</a>	<a href="#">Station Lock/Unlock</a>
<a href="#">Automatic VMS Coverage</a>	<a href="#">Feature Button</a>	<a href="#">Sub-Menus (see Auto Attendants)</a>
<a href="#">Backup Failure Alarm</a>	<a href="#">Flexible Dial Plan</a>	<a href="#">System Password</a>
<a href="#">Backup Programming Automatic</a>	<a href="#">Group Calling – Ring/Page</a>	<a href="#">System Groups</a>
<a href="#">Backup Programming Manual</a>	<a href="#">Group Hunting – Ring/Voice Signal</a>	<a href="#">Transfer / Transfer Return</a>
<a href="#">Bridging (Joining Calls)</a>	<a href="#">Group Pickup</a>	<a href="#">Transfer Return to Programmable Extension</a>
<a href="#">Call Coverage</a>	<a href="#">Hold</a>	<a href="#">Unique Line Ringing with Override</a>
<a href="#">Call Forwarding - Internal</a>	<a href="#">Hold Release on Abandon</a>	<a href="#">VMS Cover Button</a>
<a href="#">Call Log (Digital Sets only)</a>	<a href="#">Hold Reminder Tone</a>	<a href="#">VMS Cover Ring Interval</a>
<a href="#">Call Logs (ETR sets)</a>	<a href="#">Hot Dial</a>	<a href="#">VMS Hunt Delay</a>
<a href="#">Call Pickup</a>	<a href="#">Hotline</a>	<a href="#">VMS Hunt Schedule</a>
<a href="#">Call Timer</a>	<a href="#">Idle Intercom Timeout</a>	<a href="#">Voicemail</a>
<a href="#">Call Timer Continuity</a>	<a href="#">Intercom Manual Dial</a>	<a href="#">Bypass Greeting</a>
<a href="#">Call Waiting</a>	<a href="#">Intercom Dial Tone</a>	<a href="#">Change Message Status to New</a>
<a href="#">Caller ID Features</a>	<a href="#">Line Coverage Extension</a>	<a href="#">Choice of Language</a>
<a href="#">Cell Phone Connect</a>	<a href="#">Line Ringing Options</a>	<a href="#">End of Recording Options</a>
<a href="#">Centralized Telephone Programming</a>	<a href="#">Message Alert Notification</a>	<a href="#">Outcalling Notification</a>
<a href="#">CO Disconnect Time</a>	<a href="#">Music On Hold</a>	<a href="#">Phantom Mailboxes</a>
<a href="#">Conference Drop</a>	<a href="#">Network Time Synchronization</a>	<a href="#">Voicemail to E-mail</a>
<a href="#">Contact Closure Support</a>	<a href="#">Night Service</a>	<a href="#">Voice Mailbox Transfer – Direct</a>
<a href="#">Copy Settings</a>	<a href="#">On Hook Dialing</a>	<a href="#">Voice Messaging</a>
<a href="#">Direct Inward Dialing (DID)</a>	<a href="#">One Touch Transfer</a>	<a href="#">Visual Messaging</a>
<a href="#">DID to Auto Attendant</a>	<a href="#">Paging Features</a>	<a href="#">Wake-up Service</a>



---

## 911 Emergency Dialing

911 Emergency Dialing can be made from any extension, regardless of any restrictions.

---

## Abbreviated Ringing

This feature activates or deactivates Abbreviated Ringing at the system telephone at a specific extension. When you are on a call and Abbreviated Ringing is Active, any incoming call rings only once. The green light next to the line button flashes until the call is answered or the caller hangs up (or for a transferred call, until the call returns to the transfer return extension).

This feature prevents incoming calls from distracting you when you are busy on another call. To allow calls to ring repeatedly, set Abbreviated Ringing to Not Active.

---

## Absent Text Messaging

This feature allows you to post a message (such as "Do Not Disturb" or "Away from desk") on the display of your PARTNER ETR or digital system telephones. When another extension calls your extension, your active Absent Text Message appears on the caller's display.

The system provides 15 pre-defined messages, plus 2 that may be customized by each user. Pre-defined messages include:

Back Soon	Back Tomorrow	Do Not Disturb
On Vacation	Out to Lunch	At Home
Away from Desk	Be Right Back	Please Call
On Holiday until	Meeting until	Don't disturb until
With visitors until	With cust. til	At lunch until

---

## Absent Text Message Inspect

The Inspect feature is a soft-key option, and allows you to remotely inspect the active Absent Text Message at another user's extension.

Pressing the Absent Text Message button will provide you with an INSP option in the display. Press the button associated with the Inspect option and you are prompted to dial the extension number or press the Auto Intercom button you wish to view. When you do, the active message for that user is displayed.

---

## Account Code Entry

Account Code Entry (ACE) is used to enter an account code (up to 15 digits) for an incoming or outgoing call currently being handled.

The Account code is printed in the SMDR record for the call for the customer to use for cost tracking purposes.

There are two different ways the feature can be used:

- Voluntary — Account Code Entry is optional.
- Forced – Account Code Entry is mandatory before dialing on an idle CO facility.

Forced account codes are validated against a list of pre-defined account codes which is created via the Manager application.

---

## Allowed Lists / Disallowed Lists

**Allowed Lists** Use this feature to specify telephone numbers that users can dial regardless of other dialing restrictions, as long as they have access to an outside line. For example, if you restrict an entire category of calls through Disallowed Phone Number Lists (#404), you can permit calls to a specific number in that category by placing that number on an Allowed Phone Number List.

The System Administrator can create up to eight Allowed Phone Number Lists of up to 10 telephone numbers each.

**Disallowed Lists** allow you to specify telephone numbers that users cannot dial. For example, you may want to prevent calls to a specific telephone number or to categories of numbers, such as international numbers. The System Administrator can create up to eight Disallowed Phone Number Lists of up to 10 telephone numbers each.

Allowed and Disallowed Phone Numbers can be up to 12 digits long and may include 0–9, #, \*, and 'hold' (a wildcard character, displayed as "!").

---

## Attendant Positions

Extension 10 and Extension 11 serve as system attendant positions. TUI System Administration can only be done at these extensions. Night Service and Unlock capabilities can only be initialized from Extension 10. When a user dials 0, Extension 10 will ring.

---

## Auto Attendants (Multiple) / Sub-Menus / Emergency Greeting

The system supports up to 9 Automated Attendants / Sub-menus. A sub-menu is the same group of selector codes as is used in an Auto Attendant.

Each Auto Attendant has its own greeting (Morning / Afternoon / Evening), its own language (English / French / Spanish), its own set of selector codes (based on its time profile), and separate VMS Hunt and Delay Schedules.

Each Auto Attendant supports its own Emergency Greeting announcement, which can be remotely recorded and activated, and plays before the Auto Attendant Greeting.

Each Auto Attendant can be accessed by dialing the appropriate Auto Attendant dial codes (to record greetings, menu prompts, etc.).

---

## Auto Dialing

Enables a user to dial outside numbers, extension numbers, feature codes or account codes with a single touch by pressing a programmed button.

Three types of auto dial are supported:

- Auto Dial – Outside
- Auto Dial – ICM (internal extension)
- Auto Dial – ICM Page (voice signaling)

---

## Automatic Callback

When calling an extension that is busy, press the Auto Callback softkey and the system will call you when the extension becomes free.

---

## Automatic Daylight Savings Time

This feature automatically updates the system clock for annual Daylight Savings Time and Standard Time changes. Turn this feature off if you live in an area without daylight savings time.

---

## Automatic Extension Privacy

Prevents other extensions with access to the same line from joining a call. Use this feature for extensions connected to a modem, fax, or any device whose function can be disrupted by someone trying to join it.

---

## Automatic Line Selection

Specifies the order in which the system selects an available line (intercom or outside) when a user at the extension lifts the handset or presses SPEAKER to make a call without first selecting a specific line button.

For extensions with analog telephones, set Automatic Line Selection to intercom first. This enables analog telephones to access system features, including intercom calling. When users lift the handsets on analog telephones, they hear intercom dial tone. To access an outside line, they must dial 9.

---

## Automatic Voicemail Coverage

Use this feature to program a button to turn VMS Cover on and off, routing unanswered intercom and transferred calls for a users' extension to the Call Answer Service of the voice messaging system after the specified number of rings (factory setting is three rings).

---

## Backup Failure Alarm

When an Automatic Backup fails, a 'Backup Failed' message is displayed on Extension 10 and 11.

---

## Backup Programming - Automatic

The system does a nightly backup to the system SD card. No manual intervention or external PC is required.

---

## Backup Programming - Manual

The administrator may do a manual system programming backup to the system SD card via the TUI.

---

## Bridging (Joining Calls)

A user can bridge (join) on any active call by pressing the associated CO line button (assuming Privacy is not active on the originating extension.) When a call is bridged, the red and green LED's will alternate on all telephones which are bridged on the call.

---

## Call Coverage

This feature is used to redirect all Intercom, Transferred, DID and outside calls from a user's extension to another extension.

When Call Coverage is activated, covered calls are routed to the covering extension after a specified number of rings.

---

## Call Forwarding - Internal

The Call Forwarding provides a means of redirecting Intercom (ICOM), CO, and Transfer calls from one extension to another specified extension.

---

## Call Log - Digital Sets

Call Log is a fixed button on digital telephones and provides a visual record of calls made and received, including unanswered calls. Details are store for both users (maximum 30 entries) and hunt groups (maximum 10 entries). The method of operation varies according to the phone type but in all cases the call records can be used for return calls.

---

## Call Logs - ETR sets

Use this feature to program extensions to log answered Caller ID calls so that calls answered at an individual extension can be viewed in the Caller ID Call Log. Once the feature is activated for an extension, when a user activates the Caller ID Call Logging and Dialing (F23), all Caller ID calls that are answered by that extension are logged.

Up to 3 extensions can be designated to log all calls, both answered and unanswered, regardless of where they terminated in the system.

---

## Call Pickup

This feature is used to answer any intercom, transferred or outside call ringing at another specified extension.

---

## Call Timer Display

Displays the duration of a call from the time it was answered.

---

## Call Waiting

Call waiting applies to analog, single line telephones, and applies to the following types of calls:

- Intercom calls
- Transferred calls
- Forwarded calls
- Covered calls
- Outside calls (if the extension has a line appearance of the line)
- Voice Signaled calls

---

## Caller ID Features

The following Caller ID features are supported:

- **Caller ID Inspect (FEATURE 17)**  
Allows you to view Caller ID information for a second call, without disconnecting the current call or putting it on hold. Use this feature to inspect ringing, active, or held calls.
- **Caller ID Name Display (FEATURE 16)**  
When an incoming call is ringing at a display telephone, both the name and number appear on the user's display. The Number is displayed on the top line, and the Name on the 2<sup>nd</sup> line. In some cases users may wish to see the Caller ID Name on the top line and the Caller ID Number on the 2<sup>nd</sup> line. This feature provides this capability.

---

## CO Disconnect Time

Use this feature to change the hold disconnect time for an outside line. Different telephone companies use different length signals. The length of the signal is called the CO or Hold Disconnect time. If you place a call on hold and the caller hangs up, but the call does not disconnect within a minute after the caller.

---

## Conference Drop

On 1400 and 9500 digital telephones, you may choose which specific party you want to drop from a conference call. On ETR and analog telephones, the last party added to the conference call is automatically dropped.

---

## Conferencing

The system supports up to 64-party conferencing. A maximum of 2 analog lines can be in any conference call. Conference calls may consist of combinations of analog lines, digital lines (PRI/T1, SIP), analog telephones, ETR telephones or digital telephones.

---

## Contact Closure Support for 2 Devices

The IP500 V2 Control Unit has a Contact Closure control jack on the back panel. This is a 3.5 mm stereo jack that can drive two external adjunct relays.

This feature allows users at eligible extensions to control an external adjunct by entering feature codes at their system or standard telephone. The port can control a variety of devices, the most common being door strikes, night bells, lighting, or voice recording systems.

---

## Copy Settings

This feature allows a System Administrator to copy extension-specific programming from one extension to another. When the Extension Copy operation is performed, the destination extension will have the same properties as the originating extension.

Extension Copy can only be performed from an Attendant Extension in System Programming Mode or from the Windows Manager PC application.

## Dial Code Features

- 'F' represents the FEATURE button.
- 'I' represents the INTERCOM button.
- 'XX' represents a system extension number.
- 'PP' represents a Personal Speed Dial code.
- 'G' represents a single-digit group number.
- 'LL' represents a system line number.

Feature	Partner Mode Code	Norstar/BCM Code
<b>Do Not Disturb</b>	F01	F85
<b>Do Not Disturb Cancel</b>	F01	F#85
<b>Recall</b>	F03	F71
<b>Save Number Redial</b>	F04	F67
<b>Last Number Redial</b>	F05	F5
<b>Conference Drop</b>	F06	F934 (new)
<b>Privacy</b>	F07	F83
<b>Call Forward</b>	F11	F4
<b>Call Forward Cancel</b>	F11	F#4
<b>Account Code Entry</b>	F12	F900
<b>Voice Mailbox Transfer</b>	F14	F986
<b>VMS Cover</b>	F15	F984
<b>Caller ID Name Display</b>	F16	F933 (new)
<b>Caller ID Inspect</b>	F17	F811
<b>Call Coverage</b>	F20	F932 (new)
<b>Station Lock</b>	F21	F936 (new)
<b>Station Unlock</b>	F22	F937 (new)
<b>Caller ID Log</b>	F23	F812
<b>Hot Dial</b>	F26	F935 (new)
<b>Message Alert Notification</b>	F27	F938 (new)
<b>Absent Message</b>	F28	F931 (new)
<b>Contact Closure 1</b>	F41	F9*41
<b>Contact Closure 2</b>	F42	F9*42
<b>System Release</b>	F590	F9*80
<b>System IP Address</b>	F591	F9*81
<b>SD Card Serial Number</b>	F592	F9*82
<b>System Speed Dial</b>	F6XX (00-99)	F06XX (00-99)
<b>Personal Speed Dial</b>	FXX (80-99)	F*4XX (80-99)
<b>DND Override Numbers</b>	F7XX (00-19)	F07XX (00-19)
<b>Call Transfer</b>	Fixed Button	F70
<b>Voice Announce to Extension</b>	I* + XX	F66 + XX (new)
<b>Call Park to own Extension</b>	Transfer + XX	F74 (new)

## Direct Inward Dialing (DID)

Use this feature to have Direct Inward Dialing (DID) numbers on a PRI / T1 or SIP line routed automatically to a specific extension, hunt group, or calling group. When a Direct Inward Dialing (DID) call arrives, the system "collects" the digits from the T1 service provider (that is, the number that was dialed) and matches the number to a DID Mapping Table you created. If the incoming number matches an entry in the DID Mapping table, the call rings at the matching extension or hunt group.

---

## Direct Inward Dialling (DID) to Auto Attendant

DID calls can be directed to and answered by any Automated Attendant.

---

## Direct Line Pickup

With the Direct Line Pickup features, you can access a ringing or held call or a call in progress. You can also select a line to use that is not assigned to your telephone. The Direct Line Pickup features are:

- Direct Line Pickup—Active Line
- Direct Line Pickup—Idle Line

---

## Display Language

All system telephones offer the choice of 3 display language:

- US English
- Canadian French
- Latin American Spanish

Each individual extension may select their own language.

---

## Display SD Card Feature Key ID

Displays the SD Card Feature Key ID on any display telephone.

---

## Display System IP Address

Displays the IP address currently assigned to the IP500 V2 system.

---

## Display System Release

Displays the software release running on the IP500 V2 system.

---

## Distinctive / Differentiated Ringing

The system provides different ring patterns for external calls, internal calls and transferred calls.

---

## Do Not Disturb

Use this feature to be able to press a programmed button to prevent incoming calls for the extension from ringing (lights still flash). When Do Not Disturb is on, outside callers hear ringing while inside callers hear a busy signal. Calls are immediately sent to your voice mailbox.

---

## Do Not Disturb Override

Allows a user to input a list of up to 20 telephone numbers and/or internal extension numbers that will ring at the users' station when Do Not Disturb is activated.

---

## Doorphones

A doorphone is usually placed near an entrance, to screen visitors. You can connect up to two doorphones to the system.

---

## Emergency Phone Number List

Create a list of up to 10 telephone numbers that all users can dial regardless of dialing restrictions, provided they have access to an outside line. Typical list entries include fire, police and emergency services numbers.

---

## Extension Hunt Groups

Use this feature to assign any number of extensions to a Hunt Group. When extensions are in a Hunt Group, an incoming call searches or "hunts" for the longest idle extension that is available. The system supports up to six Hunt Groups.

---

## Extension Name Display

The user's name and extension number is displayed on the phone display.

---

## External Hotline

When a user lifts the handset of an external hotline, a predetermined outside number is dialed automatically. The external number might be, for example, a frequently called service bureau. The external hotline must be a single line telephone, not a system telephone, and should not have a dial pad.

---

## Fax Machine Extensions

Allows you to connect your fax machine to your system, allowing you to share network facilities.

---

## Flexible Dial Plan

Through Manager, the system defaults to a fixed 2-digit dial plan (extensions 10 – 57); but can be changed to a flexible 3-digit dial plan (extensions 100 – 599).

---

## Group Calling - Ring / Page

Use this feature to ring, page, or transfer calls simultaneously to all of the extensions in any one of four Calling Groups. (G represents a Calling Group number from 1–4.) When paging, you hear a beep and can begin speaking. Your voice is heard on the speakers of all idle system telephones in the selected Calling Group. The first extension to answer the call (on ETR sets - by picking up the handset or pressing SPEAKER, on 1400 Series sets - or by pressing the ANSWER softkey on the display) is connected to the caller.

You can group page employees for general announcements; this is an inexpensive alternative to a paging system.

---

## Group Hunting - Ring / Page

Use this feature to distribute call volume among extensions in a group, to off-load call activity from a single user. When an intercom or transferred call is placed to a Hunt Group (where G is a Hunt Group number from 1–6), the system rings or voice-signals the first available extension in the group, passing over busy extensions (or those with Do Not Disturb on) in a circular hunt. If a ringing call is not answered within three rings, the call moves to the next available extension, and so on, until the call is answered or the caller hangs up.

For a voice-signaled call, only the first available extension is signaled; if that extension does not answer, the call does not keep hunting. After an extension receives a Hunt Group call, the next call to the Hunt Group will not ring or voice-signal that extension first unless all other extensions in the group are busy or do not answer.

---

## Group Pickup

Use this feature to answer any outside, intercom, or transferred call ringing at an extension in a Pickup Group (where G is a Pickup Group number from 1–4). When a call rings at an extension that is in a Pickup Group, you can answer the call at any extension without knowing which extension or line is ringing and without being in the same Pickup Group. The system can have up to four Pickup Groups.

---

## Hold Reminder

If a call is left on hold for longer than a specified period, the extension will ring back, alerting you that the call is still on hold. This ring continues to sound until the held call is retrieved, or until the caller hangs up.

---

## Hot Dial

This feature enables a user to start dialing a number without first pressing the speaker button or going off-hook.

---

## Hotline

This feature allows designated extensions to automatically place an intercom call to another designated extension, when it goes off-hook.

---

## Intercom Dial Codes

- 'I' represents the INTERCOM button.
- 'XX' represents a system extension number.
- 'G' represents a single-digit group number.
- 'LL' represents a system line number.

Intercom Dial Code	Feature
I6XX	Call Pickup
I66G	Group Pickup
I68LL	Direct Line Pickup—Active Line
I70	Loudspeaker Paging
I*70	Simultaneous Paging
I7G	Group Calling—Ring
I*7G	Group Calling—Page
I77G	Group Hunting—Ring
I*77G	Group Hunting—Voice Signal
I8LL	Direct Line Pickup—Idle Line

---

## Intercom Dial Tone

Use this feature to determine the type of dial tone that the system provides at an extension. It may be necessary to change this setting to Machine (outside line) dial tone for an auto-dialing device, such as a fax or modem, that has trouble making calls. For example, if you have a modem that checks for outside line dial tone before dialing, use this procedure to change from Regular to Machine dial tone.

---

## Intercom Manual Dialing

Users can make an internal call to another extension by ringing it (dialing its extension number) or voice signaling the extension by prefixing the extension number with a \*.

---

## Line Coverage Extension

Use this feature to identify an extension as the "owner" of a specific outside line, so the extension can activate Call Coverage or VMS Cover for that line.

---

## Line Ringing Options

This feature specifies the options: Immediate Ring, Delayed Ring or No Ring for incoming calls on a line appearance programmed on the extension.



---

## Log All Calls

Up to three extensions can be designated to log all calls, both answered and unanswered, regardless of where they terminated in the system.

---

## Message Alert Notification

Message Alert Notification allows any ETR or Digital telephone, programmed with Auto Intercom buttons, to see which users have new messages waiting in their mailbox.

When the Message Alert Notification button is pressed, the DSS/BLF buttons programmed on the user's telephone will display a flashing red LED when the associated user has new voice mails waiting.

This feature may be left on at all times or deactivated by pressing the Message Alert button again.

---

## Music on Hold

Connect an audio source to the Music-On-Hold port on the processor module so that a caller hears music when placed on hold when the Music-On-Hold feature has been activated.

---

## Network Time Synchronization

Use this feature to specify whether you want to synchronize the system clock with the network time delivered by your service provider over Caller ID. If Network Time Synchronization is set to Active, the system will use the network time provided by your service provider; if it is set to Not Active, the system will use the time provided by its system clock.

---

## Night Service

When Night Service is on and a call comes in, all extensions in the Night Service Group ring immediately, regardless of normal Line Ringing settings.

---

## One-Touch Transfer

This feature allows a user to automatically transfer a connected call with one-touch -- by pressing a pre-programmed Auto Dial Intercom for the destination extension. (The *Transfer* button is not used.)

- The transfer is completed when the transferring station goes on-hook, or touches the Transfer button or Complete soft-key.
- The user initiating the transfer is able to consult and complete the transfer or blind transfer after successfully initiating a one-touch transfer.

The LEDs at the phone initiating the transfer, as well as other appearances of the call in the system, behave the same as if the user touched the *Transfer* button to initiate the transfer.

---

## Paging Features

- **Loudspeaker Paging** - Users can initiate a call (either manually dialed or intercom auto dialed) to an extension connected to an analog station port that connects them to an external loudspeaker paging system.
- **Simultaneous Paging** is a feature that pages both the external loudspeaker paging system (via the paging port) as well as voice signals all of the extensions in Calling Group 1.

---

## PBX Mode

The system can operate in Key System mode (default) where all lines appear on all telephones; or can be administered to operate in PBX-mode. PBX-mode provides 3 Intercom buttons per telephone which work similar to System Access buttons (provides intercom dial tone, dial 9 to access an outside line).

**Note:** On PARTNER ETR sets, the system provides 2 Intercom buttons per telephone.

---

## Personal Line Termination

Allows you to assign a line / lines to specific extension / extensions.

---

## Personalized Station Ringing

Allows you to assign a personalized ring pattern to an extension

---

## POTS (Plain Old Telephone Set) Support

POTS (single line analog telephones) are supported on the system. They are connected to an analog station port on the Combo module; a port on the Phone-2, Phone-8 or Phone-16 module, or to an ETR port.

---

## Privacy

Privacy prevents other users from joining on your call.

---

## Recall

Use this feature to send a timed switch hook flash over the telephone line to "recall" a new dial tone or to access certain central office features, such as Call Waiting or 3-way calling.

---

## Redialing Features

There are two features which offer redial functionality:

- Last Number Redial (FEATURE 05): Last Number Redial redials all digits dialed on the last outside call except account codes.
  - On 1400 Series telephones, there is a fixed Redial button, which allows you to scroll through and redial the last 20 number called from that telephone set.
- Save Number Redial (FEATURE 04): Saves into temporary memory the last outside number (up to 28 digits) dialed from a system telephone. Use this feature to save a number before you hang up on a busy or unanswered call. Once saved, the number can be redialed at any time. The number stays in memory until a different one is saved.

---

## Remote Call Forwarding / Mobile Twinning

Remote Call Forwarding is supported. This feature (FEATURE 11) allows a user to send internal and external calls destined for a particular extension to an external phone number (off the system) over an analog trunk. Remote Call Forwarding will not alert the internal extension, but immediately sends the call out to the predefined number.

---

## Remote Access to the Built-in Modem

This feature allows for unattended access to the built-in modem (x76) by calling into the system:

- by a DID number, or
- by transferring to the modem via the Automated Attendant.

When an Automated Attendant Selector code with the "Transfer To Number" action has the modem as its destination, the system will transfer the call to the built-in modem.

---

## Ring on Transfer

This is used to specify what the caller hears while they are being transferred. If Ring on Transfer is set to Active, callers hear ringing while they are being transferred; if it is set to Not Active callers hear beeps or Music on Hold if this is activated and a music source is connected to the system.

---

## Ringling Line Preference

When an extension is on-hook and the extension is ringing, the user simply goes off-hook to answer the call and is automatically connected to the ringing call. If more than one call is alerting, the system automatically connects the user to the longest ringing call.

---

## SD Card Start-up / Shut Down via TUI

A new TUI command is provided to shut down and restart the system SD card slot and the optional SD card slot, without shutting down the entire system. This allows for removal and reinstallation of the system SD and optional SD cards.

---

## Speed Dial Options

The system supports the following types of Speed Dialing:

- **Personal Directory - 1400 and 9500 Telephones only**  
Each user can store up to 20 frequently-dialed names and numbers in their extension. Personal Directory numbers can be dialed quickly by pressing CONTACTS and dialing the first few letters of the person's name. Personal Directory numbers programmed for a particular extension are for use only at that extension.
- **Personal Speed Dial (FEATURE 80 - 99) - ETR and Analog Telephones only.**  
Each user can store up to 20 frequently-dialed numbers (no name) in their extension. Personal Speed Dial numbers can be dialed quickly by pressing FEATURE (or # at intercom dial tone on a single-line telephone) and the two-digit speed dial code from 80 through 99. The Personal Speed Dial numbers programmed for a particular extension are for use only at that extension.

On analog telephones, a user will press the # key (instead of the Feature key) then dial the 2-digit number.

- **System Speed Dial - 1400 and 9500 Telephones only**  
System Speed Dialing is a shared list of up to 100 frequently-dialed names and numbers (FEATURE 600 - 699). All users on the system may use these numbers by pressing CONTACTS and dialing the first few letters of the party's name.
- **System Speed Dial (FEATURE 600 - 699) - ETR and Analog Telephones only.**  
System Speed Dialing is a shared list of up to 100 frequently-dialed numbers (no name) up to 28 characters in length. All users on the system may dial a System Speed Dial number by pressing FEATURE (or # at intercom dial tone on a single-line telephone) and the three digit speed dial code, from 600 through 699.

---

## Station Lock / Unlock

Station Lock helps to prevent unauthorized people from making outside calls from extensions. Users enter a four-digit code on their telephone dialpad to "lock" your extension. To unlock the phone, the user enters the identical code.

---

## Station Message Detail Reporting (SMDR)

SMDR is a call reporting feature that provides records of call activity. It is commonly used in many types of business, including Legal, Contact Centers, Sales and Real Estate. Call reporting information allows users to:

- Detect any unauthorized calls.
- Bill clients or projects.
- Bill back by department.
- Reduce telephone costs by identifying the need to change telecommunications services
- Print Caller ID information.

The output is generally sent to a PC running an optional Call Accounting software package.

---

## System Groups

The system supports the following types of groups:

- **Pickup Groups** (4 Groups) (INTERCOM 6xx)  
When a call rings at an extension assigned to a Pickup Group, a user at any other extension in the system can answer the ringing call by dialing the Pickup Group code. The Pickup Group feature helps when a user needs to answer calls on lines or pools not assigned to his or her telephone.
- **Calling Groups** (4 Groups) (INTERCOM 7x / \*7x)  
A Calling Group is a group of extensions that can be called at the same time. Any user in the system can ring or page all extensions in a Calling Group at the same time or transfer a call to a Calling Group. The first extension to pick up the call is connected to the caller. A typical use of this feature is to have callers ring into a Calling Group of sales representatives, or to create a "Page All" group.
- **Hunt Groups** (6 Groups) (INTERCOM 77G / \*77G)  
When extensions are in a Hunt Group, an incoming call searches or "hunts" for the first available extension.
- **Night Service Group** (1 Group) (#504)  
When Night Service is activated and a call comes in, all extensions assigned to the Night Service Group ring immediately, regardless of normal Line Ringing settings.

---

## System Password

Allows you to define a four-digit password that users can enter from system telephones to override dialing restrictions (if the extension has access to an outside line) or turn Night Service on and off. Not available on analog telephones.

---

## Transfer / Transfer Return

You can transfer calls to an extension or group using the TRANSFER button on a system telephone or the switchhook on a single-line telephone.

Transferred calls return to the originating extension if they are not answered. You also can program the number of times a transferred call rings before it returns to an extension.

---

## Transfer Return to a Programmable Extension

This feature provides an option to re-route unanswered transferred calls to an alternate extension.

- Programmable on a per extension basis.
- The existing System Programming option, *Transfer Return Rings*, will be used to indicate when transferred calls are returned to the Transfer Return extension.

If a call is routed to a transfer return extension and there are no available intercom appearances to terminate the call, the call will continue to alert at the transfer destination until the transfer return extension becomes available.

The default value for each transfer return extension is its own extension.

---

## Unique Line Ringing / Override Line Ringing

This feature allows users to differentiate by sound which line is ringing by assigning a ring pattern to it. Once a ring pattern is assigned to a line, incoming calls on that line ring with the assigned ring pattern.

- Eight ring patterns are available.
- Unique Line Ringing does not apply to DID calls because the channel used is not guaranteed.
- The default is pattern 1.

If the Override Line Ringing feature is active, then incoming calls on a line that ring at an extension ring with the configured extension ring pattern.

---

## Visual Voice Messaging

Supported on 1400 and 9500 digital telephones only. Allows the user to manage their voice mail messages via their display. Features supported include:

- access new /old / saved messages.
- next and previous message.
- fast forward and rewind.
- pause message.
- save, delete and copy message to other users of the system.
- change default greeting.
- change password.
- change message status from old / saved to New.

---

## Voicemail Options

- **Bypass Greeting**
  - After a call goes to an extension's voice mailbox, the caller can press the 1 key to bypass the mailbox greeting and begin recording a message.
- **Change Message Status to New (\*06)**
  - This feature provides the ability to change the status of a message from *Old* or *Saved* to *New*.
  - Users can dial \*06 at any time after the *Old* or *Saved* message begins to play through the 3 second pause after the caller information portion of the message.
    - The message is moved to the queue of New messages.
  - When a message is marked as *New*, the system does not initiate a new Voicemail to Email message, but the extension's message waiting light is illuminated.
- **Choice of Language**
  - Each Auto Attendant can have a primary language assigned to it. The language applies to the pre-recorded prompts available to that Auto Attendant. This overrides the system language setting.
  - The per-extension Display Language setting will also override the system language and change all the displays, pre-recorded greetings, and prompts to the chosen language.
- **End of Recording options**
  - When a caller has finished leaving a message in an extension's mailbox, the caller can touch the # key to signal the end of recording of the message.
  - If the message is less than 3 seconds, the system will play the following prompt: "Message too short. Deleted. Goodbye."
  - If the message is longer than 3 seconds, the system will play the following prompt: "Your message has been sent. Goodbye."
- **Outcalling Notification**
  - If you use the Outcalling option, Embedded Voicemail will call the number which you have programmed to signal that a new message has arrived in your mailbox.
    - Each user can have 1 number programmed for outcalling notification.
    - The system will make up to 3 attempts (in 5-minute intervals) to contact the user.
    - After 3 attempts, outcalling notification will cease until another new voice message arrives.
- **Phantom Mailboxes**
  - Provides voice mailbox support for all extensions (10-57), without requiring the physical hardware to be present. Extensions without hardware are called *phantom extensions*.
    - **Note:** Ports 7 and 8 of an ETR-6 module can be used for phantom extensions even though you cannot plug a phone into them.
  - Calls to a phantom extension go directly to voice mail.
    - DTMF breakout service can be used to transfer the call.
  - Phantom voice mailboxes:

- Default like a normal mailbox.
- Can be accessed remotely if the remote access feature of the mailbox is enabled.
- Voicemail to Email can be activated for a phantom mailbox via the Simplified Manager.

---

## VMS Cover

Allows you to turn VMS Cover on and off, routing unanswered intercom and transferred calls for users' extensions to the Call Answer Service of the voice messaging system after the specified number of rings.

---

## VMS Cover Ring Interval

Allows you to define the number of times a call rings before it is sent to a user's voice mailbox.

---

## VMS Hunt Delay

Allows you to determine when outside calls should be answered by the Automated Attendant of the voice messaging system. You can set the system for any number of rings, 0–6. Assigning more rings gives the operator an opportunity to answer calls before they go to the Automated Attendant.

VMS Hunt Delay is programmable on a per-line basis. In addition, you can program this feature so that calls can be handled one way during the day and a different way when the system is in Night Service.

---

## VMS Hunt Schedule Interval

Allows you to determine when outside lines are covered by the Automated Attendant. Options include all the time, only during Day operation (Night Service is off), or only during Night operation (Night Service is on).

---

## Voice Mailbox Transfer - Direct

Allows you to transfer a call directly into a user's voice mailbox without ringing their extension.

---

## Voice Messaging

The system has Embedded Voicemail included as standard. All extensions are automatically assigned a mailbox.

Embedded Voicemail also provides:

- A 2-port, single level Automated Attendant
- Separate Morning, Afternoon, Evening and Out of Hours menu greetings with time profiles
- Dial by Name capability
- Variable hours of storage:
  - 2-ports = 15 Hours
  - 4-ports = 20 Hours
  - 6-ports = 25 Hours
- Up to three minutes per message
- Fast Forward, Rewind, Replay and Skip capability
- Voicemail to e-mail capability
- Remote message retrieval
- Visual Messaging (on digital telephones only)

---

## Wake-Up Service

This feature allows a system phone (x10) to set a Wake-up Call on behalf of another user.

- When a Wake-up Call is scheduled, the system will place an intercom call to the target extension at the scheduled time.
  - Wake Up calls ring for approximately 30 seconds (and overrides DND).
  - If the target extension is busy on a call or has an alerting call, the Wake Up call is delivered to the phone as an intercom call.
  - If the Wake Up call is answered, the user will hear Music On Hold if it is active; otherwise, they will hear silence.
  - If the Wake Up call is not answered, the system will make a 2<sup>nd</sup> attempt 5 minutes later.
    - If the call is not answered after the 2<sup>nd</sup> attempt, then the Wake Up call is abandoned.
  - A scheduled Wake Up call occurs once in a 24 hour period.

# **Chapter 3.**

# **IP Office Basic Edition**

# **Norstar® Mode**



### 3. IP Office Basic Edition Norstar® Mode

The IP Office Basic Edition – Norstar® Mode (hereafter referred to as Norstar Mode) continues the evolution of communications systems for small businesses.

Norstar Mode is designed to work directly out of the box without any programming or administration, allowing users to immediately make and place calls via analog trunks.

Norstar Mode provides the end user a similar desktop experience as the PARTNER ACS: e.g. 2 dedicated intercom buttons, key system functionality, Caller ID, etc. This helps minimize training requirements and provides the end user with the same comfort level they have come to expect with the PARTNER ACS system.

Norstar Mode provides the bulk of the feature set that the PARTNER ACS R8 supported; plus integrates enhanced features from the IP Office Essential Edition platform, such as Mobile Twinning, Visual Voicemail, 64-party Conferencing, SIP Trunking, Full PRI/T1 and more.

Norstar Mode provides the same 2-digit extension numbering plan as PARTNER ACS (default), and now supports a 3-digit flexible numbering plan (extensions 100 – 599).

Norstar Mode supports all T-Series and M-Series Nortel telephones, the 1400 Series digital telephones, the 7406E and digital Mobility Wireless products, as well as most analog devices (fax, wireless headsets, analog telephones). The original MLS Series telephones and older wireless telephones are not supported.

Norstar Mode also supports a new line of Avaya 9500 Series digital telephones.

Norstar Mode includes Embedded Voicemail; providing a 2-port Automated Attendant (upgradeable to 6-ports) and voice mail coverage activated for all telephones. Embedded Voicemail offers a variable number of hours of storage:

- 2-ports = 15 hours of storage
- 4-ports = 20 hours of storage
- 6-ports = 25 hours of storage

#### System Capacities

Norstar Mode supports larger telephone and trunk capacity as follows (may not be attained simultaneously):

- **100 Telephones:**
  - Up to 100 digital telephones
  - Up to 100 analog telephones
- **64 Trunks:**
  - Up to 32 analog CO lines
  - Up to 12 BRI channels
  - 1 PRI/E1 (30 lines)
  - Up to 20 SIP lines

#### IP Office Basic Edition A-Law

When the IP500 V2 containing a IP Office A-Law SD card is first started, it will boot-up as "Basic Edition", which has the same look and feel as Norstar Mode, e.g.: out of the box operations, two intercom buttons, key system functionality, voice mailboxes on all telephones, TUI programming support, etc. "Basic Edition" makes starting and using the system quick and easy.

Users who need full IP Office Essential Edition functionality can apply the Essential edition license and the use Manager to change mode from "Basic Edition" to "Essential Edition". Once the system reboots, it re-starts as "Essential Edition" which is the way that IP Office Essential Edition works, looks and feels in Release 7.0.

## System Programming

System programming is accomplished in two ways:

- **Telephone User Interface** (TUI) from extension 10 or extension 11; and uses the same administration codes as the Norstar system.
- **Web Manager** (GUI) – IP Office Web Manager is a new browser based management tool (replacing Simplified Manager) designed to simplify the installation and maintenance process by providing an intuitive and user-friendly management tool that runs on most standard browsers. The new IP Office Web Manager eliminates the need to have windows operating system as it can run on any device that supports standard browsers.

The screenshot displays the AVAYA IP Office Web Manager main screen. At the top, there is a navigation bar with tabs for Home, User, Incoming Call Management, Outgoing Call Management, System, Monitoring, and Tools. A search bar is located on the right side of the navigation bar. Below the navigation bar, a green banner indicates "Data retrieved from IP Office successfully." The main content area is divided into several sections:

- IP500 V2 Version: 8.0 (27240)**: A visual representation of the phone system hardware.
- Hardware Installed**: A list of installed components including Control Unit (IP 500 V2), Internal Modules (COMB06210/ATM), Expansion Modules (None), and Feature Key (Local 1212146196).
- Phone User**: A summary of user statistics: Active (16), Available (0), and Inactive (32). It also lists settings for Excluded From Directory (None), Assigned With Call Forwarding (None), and Barred from making Outgoing Calls (None).
- Auto Attendant**: A table showing the configuration of auto attendants.
- System Information**: A list of system parameters including Mode (PBX), IP Address (140.147.80.64), Sub-Net Mask (255.255.255.128), Default Gateway (0.0.0.0), and System Locale (United Kingdom (English (UK))).
- Groups**: A table showing the configuration of calling groups.
- Calling List**: A table showing the configuration of calling lists.
- Features Configured**: A list of configured features including Daylight Saving (Off), System Trunks per Phone Line (1), Physical Extensions Connected (16), and Licenses (10).

Web Manager main screen

# Hardware

## Control Unit

Norstar Mode software runs on the IP500 V2 control unit. A Norstar Mode SD card or IP Office Essential Edition A-Law SD card is required and is installed in the rear of the control unit, providing operating software, Feature Key, Licenses and directs the system to boot up in Norstar mode or Quick Mode. An optional SD card may be installed in the optional SD card slot, providing redundant backup and system upgrade capabilities.

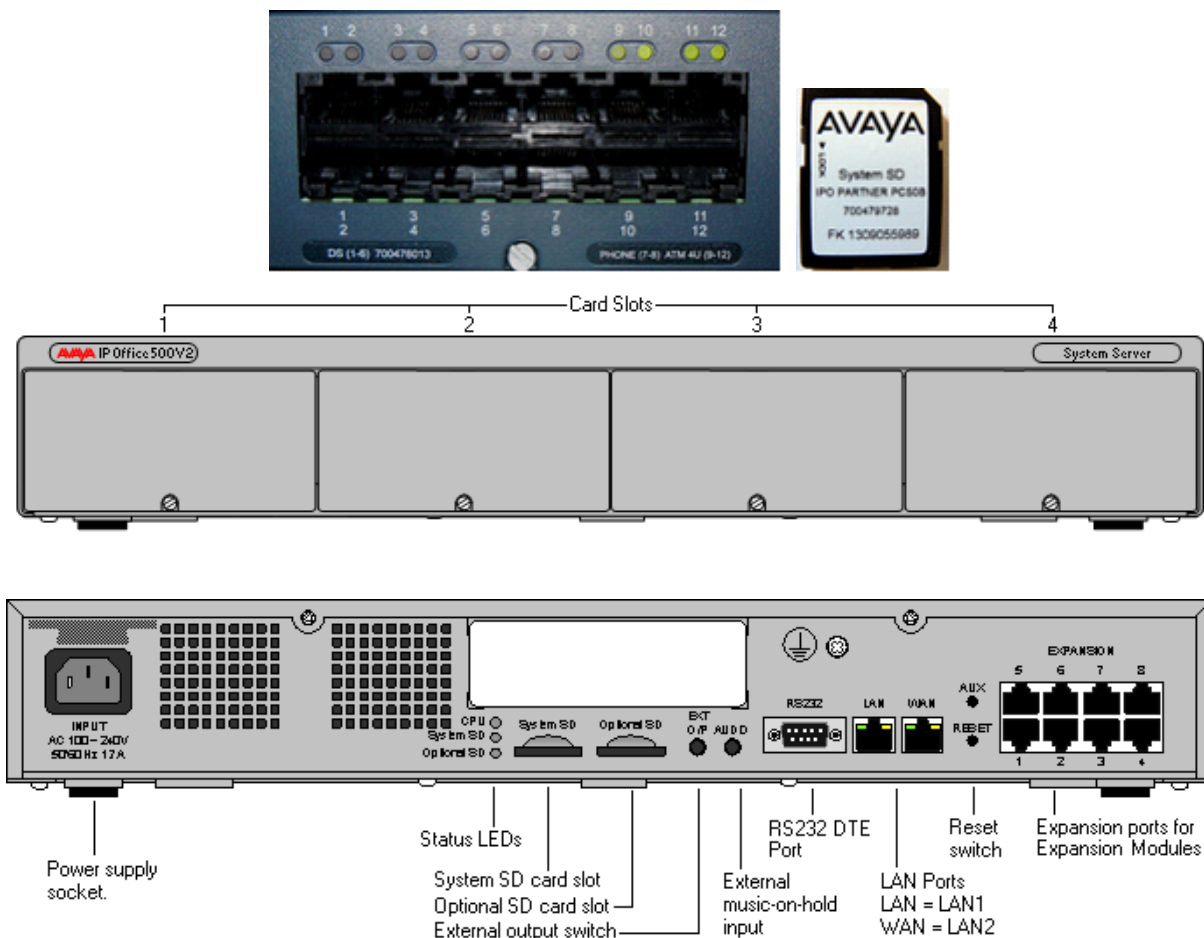

The front of the IP500 V2 Control Unit has 4 expansion bays, which supports the following system modules:

- **Combination Card – Analog Trunks**  
The Combination Card provides 6 digital station (DS) ports (Ports 1-6); 2 analog station ports (Ports 7-8); 4 CO line ports (Ports 9-12) and 10 voice compression channels.
- **Combination Card – BRI Trunks**  
The Combination Card provides 6 digital station (DS) ports (Ports 1-6); 2 analog station ports (Ports 7-8); 2 BRI trunks (Ports 9 & 10, each trunk providing 2B+D digital channels) and 10 voice compression channels.  
**Note:** The system supports a maximum of two Combination Cards of either type.
- **DS8 Card (Max 3 per system)**  
The DS8 Card provides 8 digital station ports (Ports 1-8); and supports (1) of the following optional trunk cards: ATM4, BRI4 (supports 2 BRI trunks via ports 9 & 10), BRI-8 (supports 4 BRI trunks via ports 9-12), or a PRI/E1. This card supports only the 1400 and 9500 Series telephones.  
**Note:** Each BRI trunk provides 2B+D digital channels.
- **TCM8 Card (Max 4 per system)**  
The TCM-8 Card provides 8 digital station ports (Ports 1-8); and supports (1) of the following optional trunk cards: ATM4, BRI4 (supports 2 BRI trunks via ports 9 & 10), BRI-8 (supports 4 BRI trunks via ports 9-12), or a PRI/E1. This card supports only Norstar T-Series and M-Series telephones.  
Note - each BRI trunk provides 2B+D digital channels.
- **Phone 2 (Max 4 per system)**  
The Phone 2 module provides two additional analog station ports and supports one of the following optional trunk cards: ATM4, BRI4, BRI8 or PRI/E1.

- **Phone 8 (Max 4 per system)**  
The Phone 8 module provides eight additional analog station ports and supports one of the following optional trunk cards: ATM4, BRI4, BRI8 or PRI/E1.

## Expansion Modules

Norstar Mode supports following expansion modules:

- **DS16** – provides additional 16 digital station ports (1400 and 9500 Series telephones only)
- **DS16A** – provides additional 16 digital station ports (Norstar T-Series and M-Series telephones only)
- **ATM 16 (Limit 1 per system)** – provides additional 16 analog CO lines
- **Phone 16** – provides additional 16 analog station ports
- **Phone 30** – provides additional 30 analog station ports
- **DS30** – provides additional 30 digital station ports (1400 and 9500 Series telephones only)
- **DS30A** – provides additional 30 digital station ports (Norstar T-Series and M-Series telephones only)

## Trunk Cards

Norstar Mode supports the following trunk cards, which are mounted on any DS8, TCM8, Phone 2 or Phone 8 base card:

- **ATM4** – provides four analog CO line ports. Supports Caller ID.  
Limit 4 ATM4 cards per system.
- **PRI/E1** – supports full PRI or T1.  
Limit 1 PRI/E1 card per system
- **BRI4** – provides two BRI trunks. Each BRI trunk provides 2B+D digital channels.  
Limit 4 BRI4 cards per system.
- **BRI8** – provides four BRI trunks. Each BRI trunk provides 2B+D digital channels.  
Limit 1 BRI8 card per system.



---

# Telephones

---

Norstar Mode supports the following telephones:

- [1400 Series digital telephones](#) <sup>[22]</sup>
- [9500 Series digital telephones](#) <sup>[23]</sup>
- [Norstar T-Series and M-Series digital telephones](#) <sup>[24]</sup>
- [Wireless telephones](#) <sup>[27]</sup>
- [Analog "POTS" telephones](#) <sup>[28]</sup>

---

## 1400 Series telephones

The following 1400 Series telephones are supported.

- 1416 Display Telephones
- 1408 Display Telephones
- 1403 Display Telephone
- DBM32 Button Module



### Programmable Buttons

As well as the usual dialing keys, Avaya 1400 digital telephones have dedicated function buttons like Mute, Volume, Hold, Conference and Transfer. In addition to these, there are keys that can be programmed with a range of selected special functions. These keys can be used for calling other extensions on the system (Direct Station Select or DSS keys), or can be used for options from speed dialing numbers to controlling features such as Do Not Disturb. Many features use an indicator to show whether a feature is enabled.

Button programming is done through the TUI or Simplified Manager as part of the system configuration.

## 9500 Series telephones

The following 9500 Series telephones are supported.

- 9504 Display Telephone
- 9508 Display Telephone
- BM12 Button Module



9504



9508

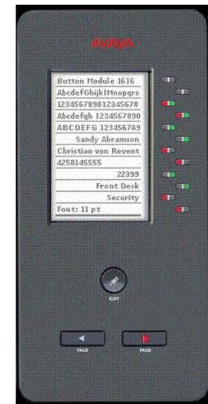

BM12

### Programmable Buttons

The Avaya 9500 Series telephones are "paper label free," providing programmable labels in the display. The 9504 has four buttons (with Red & Green LED's) and has two "pages" providing a total of 12 programmable buttons. The 9508 has eight buttons (with Red and Green LED's) and has two "pages" providing a total of 24 programmable buttons.

As well as the usual dialing keys, Avaya 9500 digital telephones have dedicated function buttons like Mute, Volume, Speaker, Headset, Call Logs and Contacts. In addition to these, there are keys that can be programmed with a range of selected special functions. These keys can be used for calling other extensions on the system (Direct Station Select or DSS keys), or can be used for options from speed dialing numbers to controlling features such as Do Not Disturb. Many features use an indicator to show whether a feature is enabled.

Button programming is done through the TUI or Simplified Manager as part of the system configuration.

---

## Norstar T-Series and M-Series telephones

The following Norstar telephones are supported on PARTNER Mode:

- T-Series Telephones: T7316E, T7208, T7100, T7000 and the T24KIM (not shown)



- M-Series Telephones: M7324, M7310 and the CAP/KLM Button Module



---

## Wireless Telephones

### T7406E Wireless



### Digital Mobility 7400/4100 Series Wireless



---

## Analog "POTS" telephones

The system supports a wide variety of industry standard analog telephones and devices, for example: fax machines, credit card readers; wireless headsets, cordless telephones.

Analog devices are connected to the system:

- To one of the analog ports on the Combination Card
- Via a Phone 2 or Phone 8 Module

The major features work the same, regardless how they are connected: e.g. Hold, Conference, Transfer, Call Waiting, Message Waiting, Incoming Caller ID.

Analog telephones have access to all dial-code features familiar to PARTNER users: e.g. Call pickup, Line pickup, Call Forwarding activation/deactivation, etc.

Analog telephones connected to a phone module or Combination Card default to intercom dial tone. To place an outgoing call, the user will dial 9. Analog telephones connected to an ETR module follows programmed Automatic Line Selection.



# System Administration

The Norstar Mode and IP Office Basic Edition A-Law can be programmed in the following ways:

- Telephone User Interface (TUI) from extension 10 or extension 11; and uses the same [administration codes](#) as the Norstar system.

TUI programming is an alternate way to do System Administration and Programming on the Norstar Mode. It is based on the Norstar TUI, but with improvements.

Using TUI System Administration on ETR, 1400, 9500 and select Norstar telephones, the buttons under the display become soft-keys which are used to navigate and change the administration items. There are also shortcut codes which enable the administrator to jump to particular administration items.

Centralized Programming is similar to System Administration, but it is used to administer buttons and other options for any telephone in the system.

Individual Programming continues to be supported, allowing the telephone user to program buttons on their telephones.

- Web Manager (GUI) – IP Office Web Manager is a new browser based management tool designed to simplify the installation and maintenance process by providing an intuitive and user-friendly management tool that runs on most standard browsers. The new IP Office Web Manager eliminates the need to have windows operating system as it can run on any device that supports standard browsers.



Web Manager main screen

For off line configuration, Upgrades, back-up and restore it is recommended that Manager continues to be used.

"Simplified Manager" is a PC GUI application inherent to the IP Office Manager application. Although system administration can be completed via either the TUI or GUI method; some advanced features such as SIP and PRI/E1 administration require the Manager application.

When you execute Manager, the program searches for any IP500 V2 units running Norstar Mode on your network and will automatically connect using the default login and password. You are then presented with a "Simplified Manager" Screen:

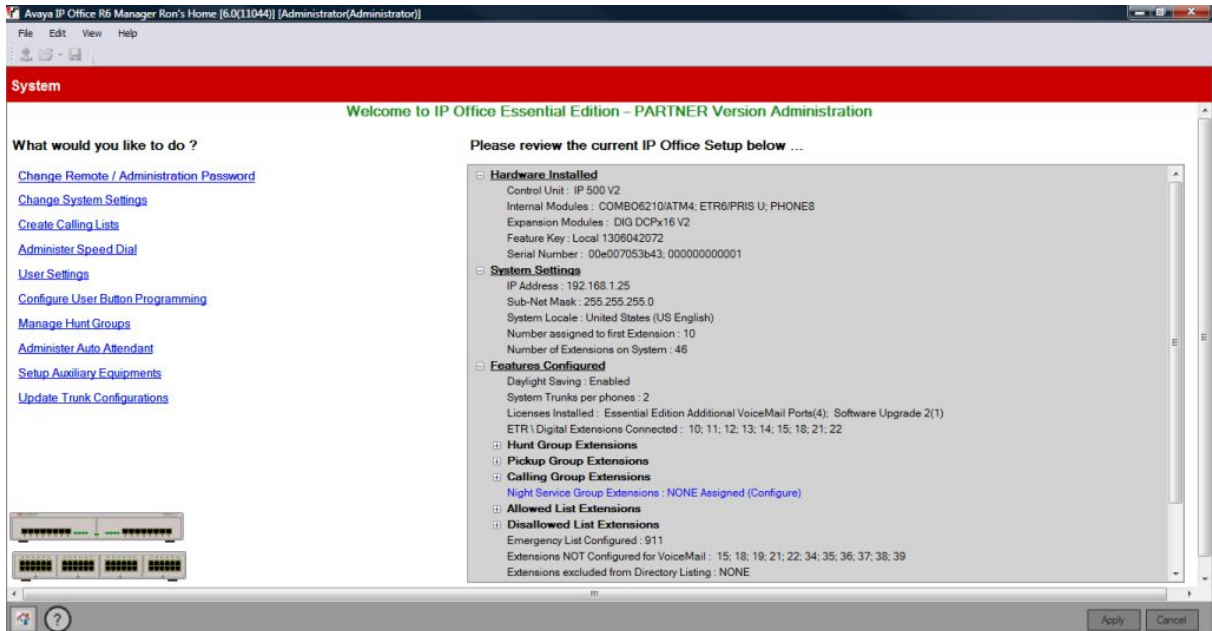

By using the system hyperlinks, you are able to quickly and easily administer the Norstar Mode system in a short time. Further details can be found in the IP Office Norstar Mode Manager documentation guide posted on the Avaya Support website.

---

## Application Programming Interface (TAPI)

Application Programming Interface (TAPI) allows new and existing server-based applications from Avaya's Developer Connection (DevConnect) program to work with and enhance the operation of the system. The current requirement is to support a screen pop type application called "Pickup IP" which is also supported on IP Office.

The TAPI API only supports 1<sup>st</sup> Party TAPI applications.

---

## System Programming Procedures

Code	Feature	Code	Feature
#101	System Date	#321	VMS Cover Rings
#103	System Time	#322	Remote Call Forwarding
#104	Number of Lines	#323	Personalized Station Ringing
#105	Transfer Return Rings	#399	Copy Settings
#107	Recall Timer Duration	#401	Outgoing Call Restriction
#109	Outside Conference Denial	#402	Toll Call Prefix
#119	Ring on Transfer	#403	System Password
#123	Backup Programming—Automatic	#405	Disallowed List Assignments
#124	Backup Programming—Manual	#406	Emergency Phone Number List
#125	Restore Programming	#407	Allowed Phone Number Lists
#126	Automatic Daylight/Standard Times	#408	Allowed List Assignments
#127	Hold Reminder Tone	#409	Forced Account Code List
#128	Network Time Synchronization	#501	Pickup Group Extensions
#203	Hold Disconnect Time	#502	Calling Group Extensions
#205	Direct Extension Dial Lines	#503	Night Service Button
#206	Group Call Distribution	#504	Night Service Group Extensions
#208	Line Coverage Extension	#505	Hunt Group Extensions
#301	Line Assignment	#506	VMS Hunt Delay
#303	Display Language	#507	VMS Hunt Schedule
#304	Automatic Extension Privacy	#601	Fax Machine Extensions
#305	Abbreviated Ringing	#602	Music-On-Hold
#306	Transfer Return Extension	#603	Hotline
#307	Forced Account Code Entry	#604	Doorphone Extension 1
#308	Distinctive Ring	#605	Doorphone Extension 2
#309	Intercom Dial Tone	#606	Doorphone Alert Extensions
#310	Automatic VMS Cover	#610	SMDR Output Format
#311	External Hotline	#612	Contact Closure Group
#316	Call Waiting	#613	Contact Closure Operation Type
#317	Caller ID Log Answered Calls	#617	Loudspeaker Paging Line
#318	Caller ID Call Log Line Association	#728	System Reset—Programming Saved
#320	Call Coverage Rings	#730	Remote Administration Password

---

## Centralized Telephone Programming

Extensions 10 and 11 can program other extensions on the system from their telephones.

---

## System Features

---

The system provides the majority of the feature set that the Norstar PARTNER ACS R8 supports. A listing of the built-in features is detailed below. Feature descriptions can be found on the following pages. TUI Feature Programming Codes (if applicable) are also provided.

<a href="#">911 Emergency Dialing</a>	<a href="#">Direct Line Pickup Features</a>	<a href="#">PBX Mode</a>
<a href="#">Abbreviated Ringing</a>	<a href="#">Display</a>	<a href="#">Personal Line Termination</a>
<a href="#">Absent Text</a>	<a href="#">Display Language</a>	<a href="#">Personalized Station Ringing</a>
<a href="#">Absent Text Message Inspect</a>	<a href="#">Display SD Card Feature Key ID</a>	<a href="#">POT Support</a>
<a href="#">Account Codes</a>	<a href="#">Display System IP Address</a>	<a href="#">Privacy</a>
<a href="#">Allowed/Disallowed Lists</a>	<a href="#">Display System Release</a>	<a href="#">Recall</a>
<a href="#">Application Programming Interface (TAPI)</a>	<a href="#">Distinctive / Differentiated Ring</a>	<a href="#">Redialing Features</a>
<a href="#">Attendant/Operator Positions</a>	<a href="#">Do Not Disturb (Send All Calls)</a>	<a href="#">Remote Call Forwarding / Mobile Twinning</a>
<a href="#">Auto Attendants - Emergency Greeting</a>	<a href="#">Do Not Disturb Override</a>	<a href="#">Remote Access to Modem</a>
<a href="#">Auto Attendants - Multiple</a>	<a href="#">Doorphones (max of 2)</a>	<a href="#">Ringing Line Preference</a>
<a href="#">Automatic Callback</a>	<a href="#">Emergency Phone Number List</a>	<a href="#">Ring on Transfer</a>
<a href="#">Automatic Daylight Savings Time</a>	<a href="#">External Hotline</a>	<a href="#">SD Card Startup / Shut Down via TUI</a>
<a href="#">Automatic Extension Privacy</a>	<a href="#">Extension Hunt Groups</a>	<a href="#">SMDR</a>
<a href="#">Auto Dialing</a>	<a href="#">Extension Name Display</a>	<a href="#">Speed Dial Features</a>
<a href="#">Automatic Line Selection</a>	<a href="#">Fax Machine Extensions</a>	<a href="#">Station Lock/Unlock</a>
<a href="#">Automatic VMS Coverage</a>	<a href="#">Feature Button</a>	<a href="#">Sub-Menus (see Auto Attendants)</a>
<a href="#">Backup Failure Alarm</a>	<a href="#">Flexible Dial Plan</a>	<a href="#">System Password</a>
<a href="#">Backup Programming Automatic</a>	<a href="#">Group Calling – Ring/Page</a>	<a href="#">System Groups</a>
<a href="#">Backup Programming Manual</a>	<a href="#">Group Hunting – Ring/Voice Signal</a>	<a href="#">Transfer / Transfer Return</a>
<a href="#">Bridging (Joining Calls)</a>	<a href="#">Group Pickup</a>	<a href="#">Transfer Return to Programmable Extension</a>
<a href="#">Call Coverage</a>	<a href="#">Hold</a>	<a href="#">Unique Line Ringing with Override</a>
<a href="#">Call Forwarding - Internal</a>	<a href="#">Hold Release on Abandon</a>	<a href="#">VMS Cover Button</a>
<a href="#">Call Log (Digital Sets only)</a>	<a href="#">Hold Reminder Tone</a>	<a href="#">VMS Cover Ring Interval</a>
<a href="#">Call Logs (ETR sets)</a>	<a href="#">Hot Dial</a>	<a href="#">VMS Hunt Delay</a>
<a href="#">Call Pickup</a>	<a href="#">Hotline</a>	<a href="#">VMS Hunt Schedule</a>
<a href="#">Call Timer</a>	<a href="#">Idle Intercom Timeout</a>	<a href="#">Voicemail</a>
<a href="#">Call Timer Continuity</a>	<a href="#">Intercom Manual Dial</a>	<a href="#">Bypass Greeting</a>
<a href="#">Call Waiting</a>	<a href="#">Intercom Dial Tone</a>	<a href="#">Change Message Status to New</a>
<a href="#">Caller ID Features</a>	<a href="#">Line Coverage Extension</a>	<a href="#">Choice of Language</a>
<a href="#">Cell Phone Connect</a>	<a href="#">Line Ringing Options</a>	<a href="#">End of Recording Options</a>
<a href="#">Centralized Telephone Programming</a>	<a href="#">Message Alert Notification</a>	<a href="#">Outcalling Notification</a>
<a href="#">CO Disconnect Time</a>	<a href="#">Music On Hold</a>	<a href="#">Phantom Mailboxes</a>
<a href="#">Conference Drop</a>	<a href="#">Network Time Synchronization</a>	<a href="#">Voicemail to E-mail</a>
<a href="#">Contact Closure Support</a>	<a href="#">Night Service</a>	<a href="#">Voice Mailbox Transfer – Direct</a>
<a href="#">Copy Settings</a>	<a href="#">On Hook Dialing</a>	<a href="#">Voice Messaging</a>
<a href="#">Direct Inward Dialing (DID)</a>	<a href="#">One Touch Transfer</a>	<a href="#">Visual Messaging</a>
<a href="#">DID to Auto Attendant</a>	<a href="#">Paging Features</a>	<a href="#">Wake-up Service</a>

---

## 911 Emergency Dialing

911 Emergency Dialing can be made from any extension, regardless of any restrictions.

---

## Abbreviated Ringing

This feature activates or deactivates Abbreviated Ringing at the system telephone at a specific extension. When you are on a call and Abbreviated Ringing is Active, any incoming call rings only once. The green light next to the line button flashes until the call is answered or the caller hangs up (or for a transferred call, until the call returns to the transfer return extension).

This feature prevents incoming calls from distracting you when you are busy on another call. To allow calls to ring repeatedly, set Abbreviated Ringing to Not Active.

---

## Absent Text Messaging

This feature allows you to post a message (such as "Do Not Disturb" or "Away from desk") on the display of your PARTNER ETR or digital system telephones. When another extension calls your extension, your active Absent Text Message appears on the caller's display.

The system provides 15 pre-defined messages, plus 2 that may be customized by each user. Pre-defined messages include:

Back Soon	Back Tomorrow	Do Not Disturb
On Vacation	Out to Lunch	At Home
Away from Desk	Be Right Back	Please Call
On Holiday until	Meeting until	Don't disturb until
With visitors until	With cust. til	At lunch until

---

## Absent Text Message Inspect

The Inspect feature is a soft-key option, and allows you to remotely inspect the active Absent Text Message at another user's extension.

Pressing the Absent Text Message button will provide you with an INSP option in the display. Press the button associated with the Inspect option and you are prompted to dial the extension number or press the Auto Intercom button you wish to view. When you do, the active message for that user is displayed.

---

## Account Code Entry

Account Code Entry (ACE) is used to enter an account code (up to 15 digits) for an incoming or outgoing call currently being handled.

The Account code is printed in the SMDR record for the call for the customer to use for cost tracking purposes.

There are two different ways the feature can be used:

- Voluntary — Account Code Entry is optional.
- Forced – Account Code Entry is mandatory before dialing on an idle CO facility.

Forced account codes are validated against a list of pre-defined account codes which is created via the Manager application.

---

## Allowed Lists / Disallowed Lists

**Allowed Lists** Use this feature to specify telephone numbers that users can dial regardless of other dialing restrictions, as long as they have access to an outside line. For example, if you restrict an entire category of calls through Disallowed Phone Number Lists (#404), you can permit calls to a specific number in that category by placing that number on an Allowed Phone Number List.

The System Administrator can create up to eight Allowed Phone Number Lists of up to 10 telephone numbers each.

**Disallowed Lists** allow you to specify telephone numbers that users cannot dial. For example, you may want to prevent calls to a specific telephone number or to categories of numbers, such as international numbers. The System Administrator can create up to eight Disallowed Phone Number Lists of up to 10 telephone numbers each.

Allowed and Disallowed Phone Numbers can be up to 12 digits long and may include 0–9, #, \*, and 'hold' (a wildcard character, displayed as "!").

---

## Attendant Positions

Extension 10 and Extension 11 serve as system attendant positions. TUI System Administration can only be done at these extensions. Night Service and Unlock capabilities can only be initialized from Extension 10. When a user dials 0, Extension 10 will ring.

---

## Auto Attendants (Multiple) / Sub-Menus / Emergency Greeting

The system supports up to 9 Automated Attendants / Sub-menus. A sub-menu is the same group of selector codes as is used in an Auto Attendant.

Each Auto Attendant has its own greeting (Morning / Afternoon / Evening), its own language (English / French / Spanish), its own set of selector codes (based on its time profile), and separate VMS Hunt and Delay Schedules.

Each Auto Attendant supports its own Emergency Greeting announcement, which can be remotely recorded and activated, and plays before the Auto Attendant Greeting.

Each Auto Attendant can be accessed by dialing the appropriate Auto Attendant dial codes (to record greetings, menu prompts, etc.).

---

## Auto Dialing

Enables a user to dial outside numbers, extension numbers, feature codes or account codes with a single touch by pressing a programmed button.

Three types of auto dial are supported:

- Auto Dial – Outside
- Auto Dial – ICM (internal extension)
- Auto Dial – ICM Page (voice signaling)

---

## Automatic Callback

When calling an extension that is busy, press the Auto Callback softkey and the system will call you when the extension becomes free.

---

## Automatic Daylight Savings Time

This feature automatically updates the system clock for annual Daylight Savings Time and Standard Time changes. Turn this feature off if you live in an area without daylight savings time.

---

## Automatic Extension Privacy

Prevents other extensions with access to the same line from joining a call. Use this feature for extensions connected to a modem, fax, or any device whose function can be disrupted by someone trying to join it.

---

## Automatic Line Selection

Specifies the order in which the system selects an available line (intercom or outside) when a user at the extension lifts the handset or presses SPEAKER to make a call without first selecting a specific line button.

For extensions with analog telephones, set Automatic Line Selection to intercom first. This enables analog telephones to access system features, including intercom calling. When users lift the handsets on analog telephones, they hear intercom dial tone. To access an outside line, they must dial 9.

---

## Automatic Voicemail Coverage

Use this feature to program a button to turn VMS Cover on and off, routing unanswered intercom and transferred calls for a users' extension to the Call Answer Service of the voice messaging system after the specified number of rings (factory setting is three rings).

---

## Backup Failure Alarm

When an Automatic Backup fails, a 'Backup Failed' message is displayed on Extension 10 and 11.

---

## Backup Programming - Automatic

The system does a nightly backup to the system SD card. No manual intervention or external PC is required.

---

## Backup Programming - Manual

The administrator may do a manual system programming backup to the system SD card via the TUI.

---

## Bridging (Joining Calls)

A user can bridge (join) on any active call by pressing the associated CO line button (assuming Privacy is not active on the originating extension.) When a call is bridged, the red and green LED's will alternate on all telephones which are bridged on the call.

---

## Call Coverage

This feature is used to redirect all Intercom, Transferred, DID and outside calls from a user's extension to another extension.

When Call Coverage is activated, covered calls are routed to the covering extension after a specified number of rings.

---

## Call Forwarding - Internal

The Call Forwarding provides a means of redirecting Intercom (ICOM), CO, and Transfer calls from one extension to another specified extension.

---

## Call Log - Digital Telephones

Call Log is a fixed button on digital telephones and provides a visual record of calls made and received, including unanswered calls. Details are store for both users (maximum 30 entries) and hunt groups (maximum 10 entries). The method of operation varies according to the phone type but in all cases the call records can be used for return calls.

---

## Call Logs - ETR Telephones

Use this feature to program extensions to log answered Caller ID calls so that calls answered at an individual extension can be viewed in the Caller ID Call Log. Once the feature is activated for an extension, when a user activates the Caller ID Call Logging and Dialing (F23), all Caller ID calls that are answered by that extension are logged.

Up to 3 extensions can be designated to log all calls, both answered and unanswered, regardless of where they terminated in the system.

---

## Call Timer Display

Displays the duration of a call from the time it was answered.

---

## Call Waiting

Call waiting applies to analog, single line telephones, and applies to the following types of calls:

- Intercom calls
- Transferred calls
- Forwarded calls
- Covered calls
- Outside calls (if the extension has a line appearance of the line)
- Voice Signaled calls

---

## Caller ID Features

The following Caller ID features are supported:

- **Caller ID Inspect (FEATURE 17)**  
Allows you to view Caller ID information for a second call, without disconnecting the current call or putting it on hold. Use this feature to inspect ringing, active, or held calls.
- **Caller ID Name Display (FEATURE 16)**  
When an incoming call is ringing at a display telephone, both the name and number appear on the user's display. The Number is displayed on the top line, and the Name on the 2<sup>nd</sup> line. In some cases users may wish to see the Caller ID Name on the top line and the Caller ID Number on the 2<sup>nd</sup> line. This feature provides this capability.

---

## CO Disconnect Time (Programmable)

Use this feature to change the hold disconnect time for an outside line. Different telephone companies use different length signals. The length of the signal is called the CO or Hold Disconnect time. If you place a call on hold and the caller hangs up, but the call does not disconnect within a minute after the caller.

---

## Conference Drop

On 1400 and 9500 digital telephones, you may choose which specific party you want to drop from a conference call. On ETR and analog telephones, the last party added to the conference call is automatically dropped.

---

## Conferencing

The system supports up to 64-party conferencing. A maximum of 2 analog lines can be in any conference call. Conference calls may consist of combinations of analog lines, digital lines (PRI/T1, SIP), analog telephones, ETR telephones or digital telephones.

---

## Contact Closure Support for 2 Devices

The IP500 V2 Control Unit has a Contact Closure control jack on the back panel. This is a 3.5 mm stereo jack that can drive two external adjunct relays.

This feature allows users at eligible extensions to control an external adjunct by entering feature codes at their system or standard telephone. The port can control a variety of devices, the most common being door strikes, night bells, lighting, or voice recording systems.

---

## Copy Settings

This feature allows a System Administrator to copy extension-specific programming from one extension to another. When the Extension Copy operation is performed, the destination extension will have the same properties as the originating extension.

Extension Copy can only be performed from an Attendant Extension in System Programming Mode or from the Windows Manager PC application.



---

## Dial Code Features

- 'F' represents the FEATURE button.
- 'I' represents the INTERCOM button.
- 'XX' represents a system extension number.
- 'PP' represents a Personal Speed Dial code.
- 'G' represents a single-digit group number.
- 'LL' represents a system line number.

Feature	Partner Mode Code	Norstar/BCM Code
Do Not Disturb	F01	F85
Do Not Disturb Cancel	F01	F#85
Recall	F03	F71
Save Number Redial	F04	F67
Last Number Redial	F05	F5
Conference Drop	F06	F934 (new)
Privacy	F07	F83
Call Forward	F11	F4
Call Forward Cancel	F11	F#4
Account Code Entry	F12	F900
Voice Mailbox Transfer	F14	F986
VMS Cover	F15	F984
Caller ID Name Display	F16	F933 (new)
Caller ID Inspect	F17	F811
Call Coverage	F20	F932 (new)
Station Lock	F21	F936 (new)
Station Unlock	F22	F937 (new)
Caller ID Log	F23	F812
Hot Dial	F26	F935 (new)
Message Alert Notification	F27	F938 (new)
Absent Message	F28	F931 (new)
Contact Closure 1	F41	F9*41
Contact Closure 2	F42	F9*42
System Release	F590	F9*80
System IP Address	F591	F9*81
SD Card Serial Number	F592	F9*82
System Speed Dial	F6XX (00-99)	F06XX (00-99)
Personal Speed Dial	FXX (80-99)	F*4XX (80-99)
DND Override Numbers	F7XX (00-19)	F07XX (00-19)
Call Transfer	Fixed Button	F70
Voice Announce to Extension	I* + XX	F66 + XX (new)
Call Park to own Extension	Transfer + XX	F74 (new)

---

## Direct Inward Dialing (DID)

Use this feature to have Direct Inward Dialing (DID) numbers on a PRI / T1 or SIP line routed automatically to a specific extension, hunt group, or calling group. When a Direct Inward Dialing (DID) call arrives, the system "collects" the digits from the T1 service provider (that is, the number that was dialed) and matches the number to a DID Mapping Table you created. If the incoming number matches an entry in the DID Mapping table, the call rings at the matching extension or hunt group.

---

## Direct Inward Dialing (DID) to Auto Attendant

DID calls can be directed to and answered by any Automated Attendant.

---

## Direct Line Pickup

With the Direct Line Pickup features, you can access a ringing or held call or a call in progress. You can also select a line to use that is not assigned to your telephone. The Direct Line Pickup features are:

- Direct Line Pickup—Active Line
- Direct Line Pickup—Idle Line

---

## Display Language

All system telephones offer the choice of 3 display language:

- US English
- Canadian French
- Latin American Spanish

Each individual extension may select their own language.

---

## Display SD Card Feature Key ID

Displays the SD Card Feature Key ID on any display telephone.

---

## Display System IP Address

Displays the IP address currently assigned to the IP500 V2 system.

---

## Display System Release

Displays the software release running on the IP500 V2 system.

---

## Distinctive / Differentiated Ringing

The system provides different ring patterns for external calls, internal calls and transferred calls.

---

## Do Not Disturb

Use this feature to be able to press a programmed button to prevent incoming calls for the extension from ringing (lights still flash). When Do Not Disturb is on, outside callers hear ringing while inside callers hear a busy signal. Calls are immediately sent to your voice mailbox.

---

## Do Not Disturb Exceptions

Allows a user to input a list of up to 20 telephone numbers and/or internal extension numbers that will ring at the users' station when Do Not Disturb is activated.

---

## Doorphones

A doorphone is usually placed near an entrance, to screen visitors. You can connect up to two doorphones to the system.

---

## Emergency Phone Number List

Create a list of up to 10 telephone numbers that all users can dial regardless of dialing restrictions, provided they have access to an outside line. Typical list entries include fire, police and emergency services numbers.

---

## Extension Hunt Groups

Use this feature to assign any number of extensions to a Hunt Group. When extensions are in a Hunt Group, an incoming call searches or "hunts" for the longest idle extension that is available. The system supports up to six Hunt Groups.

---

## Extension Name Display

The user's name and extension number is displayed on the phone display.

---

## External Hotline

When a user lifts the handset of an external hotline, a predetermined outside number is dialed automatically. The external number might be, for example, a frequently called service bureau. The external hotline must be a single line telephone, not a system telephone, and should not have a dial pad.

---

## Fax Machine Extensions

Allows you to connect your fax machine to your system, allowing you to share network facilities.

---

## Flexible Dial Plan

Through Manager, the system defaults to a fixed 2-digit dial plan (extensions 10 – 57); but can be changed to a flexible 3-digit dial plan (extensions 100 – 599).

---

## Group Calling - Ring / Page

Use this feature to ring, page, or transfer calls simultaneously to all of the extensions in any one of four Calling Groups. (G represents a Calling Group number from 1–4.) When paging, you hear a beep and can begin speaking. Your voice is heard on the speakers of all idle system telephones in the selected Calling Group. The first extension to answer the call (on ETR sets - by picking up the handset or pressing SPEAKER, on 1400 Series sets - or by pressing the ANSWER softkey on the display) is connected to the caller.

You can group page employees for general announcements; this is an inexpensive alternative to a paging system.

---

## Group Hunting - Ring / Page

Use this feature to distribute call volume among extensions in a group, to off-load call activity from a single user. When an intercom or transferred call is placed to a Hunt Group (where G is a Hunt Group number from 1–6), the system rings or voice-signals the first available extension in the group, passing over busy extensions (or those with Do Not Disturb on) in a circular hunt. If a ringing call is not answered within three rings, the call moves to the next available extension, and so on, until the call is answered or the caller hangs up.

For a voice-signal call, only the first available extension is signaled; if that extension does not answer, the call does not keep hunting. After an extension receives a Hunt Group call, the next call to the Hunt Group will not ring or voice-signal that extension first unless all other extensions in the group are busy or do not answer.

---

## Group Pickup

Use this feature to answer any outside, intercom, or transferred call ringing at an extension in a Pickup Group (where G is a Pickup Group number from 1–4). When a call rings at an extension that is in a Pickup Group, you can answer the call at any extension without knowing which extension or line is ringing and without being in the same Pickup Group. The system can have up to four Pickup Groups.

---

## Hold Reminder

If a call is left on hold for longer than a specified period, the extension will ring back, alerting you that the call is still on hold. This ring continues to sound until the held call is retrieved, or until the caller hangs up.

---

## Hot Dial

This feature enables a user to start dialing a number without first pressing the speaker button or going off-hook.

---

## Hotline

This feature allows designated extensions to automatically place an intercom call to another designated extension, when it goes off-hook.

---

## Intercom Dial Codes

- 'I' represents the INTERCOM button.
- 'XX' represents a system extension number.
- 'G' represents a single-digit group number.
- 'LL' represents a system line number.

Intercom Dial Code	Feature
I6XX	Call Pickup
I66G	Group Pickup
I68LL	Direct Line Pickup—Active Line
I70	Loudspeaker Paging
I*70	Simultaneous Paging
I7G	Group Calling—Ring
I*7G	Group Calling—Page
I77G	Group Hunting—Ring
I*77G	Group Hunting—Voice Signal
I8LL	Direct Line Pickup—Idle Line

---

## Intercom Dial Tone

Use this feature to determine the type of dial tone that the system provides at an extension. It may be necessary to change this setting to Machine (outside line) dial tone for an auto-dialing device, such as a fax or modem, that has trouble making calls. For example, if you have a modem that checks for outside line dial tone before dialing, use this procedure to change from Regular to Machine dial tone.

---

## Intercom Manual Dialing

Users can make an internal call to another extension by ringing it (dialing its extension number) or voice signaling the extension by prefixing the extension number with a \*.

---

## Line Coverage Extension

Use this feature to identify an extension as the "owner" of a specific outside line, so the extension can activate Call Coverage or VMS Cover for that line.

---

## Line Ringing Options

This feature specifies the options: Immediate Ring, Delayed Ring or No Ring for incoming calls on a line appearance programmed on the extension.

---

## Log All Calls

Up to three extensions can be designated to log all calls, both answered and unanswered, regardless of where they terminated in the system.

---

## Message Alert Notification

Message Alert Notification allows any ETR or Digital telephone, programmed with Auto Intercom buttons, to see which users have new messages waiting in their mailbox.

When the Message Alert Notification button is pressed, the DSS/BLF buttons programmed on the user's telephone will display a flashing red LED when the associated user has new voice mails waiting.

This feature may be left on at all times or deactivated by pressing the Message Alert button again.

---

## Music on Hold

Connect an audio source to the Music-On-Hold port on the processor module so that a caller hears music when placed on hold when the Music-On-Hold feature has been activated.

---

## Night Service

When Night Service is on and a call comes in, all extensions in the Night Service Group ring immediately, regardless of normal Line Ringing settings.

---

## One-Touch Transfer

This feature allows a user to automatically transfer a connected call with one-touch -- by pressing a pre-programmed Auto Dial Intercom for the destination extension. (The *Transfer* button is not used.)

- The transfer is completed when the transferring station goes on-hook, or touches the Transfer button or Complete soft-key.
- The user initiating the transfer is able to consult and complete the transfer or blind transfer after successfully initiating a one-touch transfer.

The LEDs at the phone initiating the transfer, as well as other appearances of the call in the system, behave the same as if the user touched the *Transfer* button to initiate the transfer.

---

## Paging Features

- **Loudspeaker Paging** - Users can initiate a call (either manually dialed or intercom auto dialed) to an extension connected to an analog station port that connects them to an external loudspeaker paging system.
- **Simultaneous Paging** is a feature that pages both the external loudspeaker paging system (via the paging port) as well as voice signals all of the extensions in Calling Group 1.

---

## PBX Mode

The system can operate in Key System mode (default) where all lines appear on all telephones; or can be administered to operate in PBX-mode. PBX-mode provides three Intercom buttons per telephone which work similar to System Access buttons (provides intercom dial tone, dial 9 to access an outside line).

**Note:** On PARTNER ETR sets, the system provides two Intercom buttons per telephone.

---

## Personal Line Termination

Allows you to assign a line / lines to specific extension / extensions.

---

## Personalized Station Ringing

Allows you to assign a personalized ring pattern to an extension

---

## POTS (Plain Old Telephone Set) Support

POTS (single line analog telephones) are supported on the system. They are connected to an analog station port on the Combo module; a port on the Phone-2, Phone-8 or Phone-16 module, or to an ETR port.

---

## Privacy

Privacy prevents other users from joining on your call.

---

## Recall

Use this feature to send a timed switch hook flash over the telephone line to "recall" a new dial tone or to access certain central office features, such as Call Waiting or 3-way calling.

---

## Redialing Features

There are two features which offer redial functionality:

- Last Number Redial (FEATURE 05): Last Number Redial redials all digits dialed on the last outside call except account codes.
  - On 1400 Series telephones, there is a fixed Redial button, which allows you to scroll through and redial the last 20 number called from that telephone set.
- Save Number Redial (FEATURE 04): Saves into temporary memory the last outside number (up to 28 digits) dialed from a system telephone. Use this feature to save a number before you hang up on a busy or unanswered call. Once saved, the number can be redialed at any time. The number stays in memory until a different one is saved.

---

## Remote Call Forwarding

Remote Call Forwarding is supported. This feature (FEATURE 11) allows a user to send internal and external calls destined for a particular extension to an external phone number (off the system) over an analog trunk. Remote Call Forwarding will not alert the internal extension, but immediately sends the call out to the predefined number.

---

## Remote Access to the Built-in Modem

This feature allows for unattended access to the built-in modem (x76) by calling into the system:

- by a DID number, or
- by transferring to the modem via the Automated Attendant.

When an Automated Attendant Selector code with the "Transfer To Number" action has the modem as its destination, the system will transfer the call to the built-in modem.

---

## Ring on Transfer

This is used to specify what the caller hears while they are being transferred. If Ring on Transfer is set to Active, callers hear ringing while they are being transferred; if it is set to Not Active callers hear beeps or Music on Hold if this is activated and a music source is connected to the system.

---

## Ringling Line Preference

When an extension is on-hook and the extension is ringing, the user simply goes off-hook to answer the call and is automatically connected to the ringing call. If more than one call is alerting, the system automatically connects the user to the longest ringing call.

---

## SD Card Start-up / Shut Down via TUI

A new TUI command is provided to shut down and restart the system SD card slot and the optional SD card slot, without shutting down the entire system. This allows for removal and reinstallation of the system SD and optional SD cards.

---

## Speed Dial Options

The system supports the following types of Speed Dialing:

- **Personal Directory - 1400 and 9500 Telephones only**  
Each user can store up to 20 frequently-dialed names and numbers in their extension. Personal Directory numbers can be dialed quickly by pressing CONTACTS and dialing the first few letters of the person's name. Personal Directory numbers programmed for a particular extension are for use only at that extension.
- **Personal Speed Dial (FEATURE 80 – 99) – ETR and Analog Telephones only.**  
Each user can store up to 20 frequently-dialed numbers (no name) in their extension. Personal Speed Dial numbers can be dialed quickly by pressing FEATURE (or # at intercom dial tone on a single-line telephone) and the two-digit speed dial code from 80 through 99. The Personal Speed Dial numbers programmed for a particular extension are for use only at that extension.

On analog telephones, a user will press the # key (instead of the Feature key) then dial the 2-digit number.

- **System Speed Dial – 1400 and 9500 Telephones only**  
System Speed Dialing is a shared list of up to 100 frequently-dialed names and numbers (FEATURE 600 – 699). All users on the system may use these numbers by pressing CONTACTS and dialing the first few letters of the party's name.
- **System Speed Dial (FEATURE 600 – 699) – ETR and Analog Telephones only.**  
System Speed Dialing is a shared list of up to 100 frequently-dialed numbers (no name) up to 28 characters in length. All users on the system may dial a System Speed Dial number by pressing FEATURE (or # at intercom dial tone on a single-line telephone) and the three digit speed dial code, from 600 through 699.

---

## Station Lock / Unlock

Station Lock helps to prevent unauthorized people from making outside calls from extensions. Users enter a four-digit code on their telephone dialpad to "lock" your extension. To unlock the phone, the user enters the identical code.

---

## Station Message Detail Reporting (SMDR)

SMDR is a call reporting feature that provides records of call activity. It is commonly used in many types of business, including Legal, Contact Centers, Sales and Real Estate. Call reporting information allows users to:

- Detect any unauthorized calls.
- Bill clients or projects.
- Bill back by department.
- Reduce telephone costs by identifying the need to change telecommunications services
- Print Caller ID information.

The output is generally sent to a PC running an optional Call Accounting software package.

---

## System Groups

The system supports the following types of groups:

- **Pickup Groups (4 Groups) (INTERCOM 6xx)**  
When a call rings at an extension assigned to a Pickup Group, a user at any other extension in the system can answer the ringing call by dialing the Pickup Group code. The Pickup Group feature helps when a user needs to answer calls on lines or pools not assigned to his or her telephone.

- **Calling Groups** (4 Groups) (INTERCOM 7x / \*7x)  
A Calling Group is a group of extensions that can be called at the same time. Any user in the system can ring or page all extensions in a Calling Group at the same time or transfer a call to a Calling Group. The first extension to pick up the call is connected to the caller. A typical use of this feature is to have callers ring into a Calling Group of sales representatives, or to create a "Page All" group.
- **Hunt Groups** (6 Groups) (INTERCOM 77G / \*77G)  
When extensions are in a Hunt Group, an incoming call searches or "hunts" for the first available extension.
- **Night Service Group** (1 Group) (#504)  
When Night Service is activated and a call comes in, all extensions assigned to the Night Service Group ring immediately, regardless of normal Line Ringing settings.

---

## System Password

Allows you to define a four-digit password that users can enter from system telephones to override dialing restrictions (if the extension has access to an outside line) or turn Night Service on and off. Not available on analog telephones.

---

## Transfer / Transfer Return

You can transfer calls to an extension or group using the TRANSFER button on a system telephone or the switchhook on a single-line telephone.

Transferred calls return to the originating extension if they are not answered. You also can program the number of times a transferred call rings before it returns to an extension.

---

## Transfer Return to a Programmable Extension

This feature provides an option to re-route unanswered transferred calls to an alternate extension.

- Programmable on a per extension basis.
- The existing System Programming option, *Transfer Return Rings*, will be used to indicate when transferred calls are returned to the Transfer Return extension.

If a call is routed to a transfer return extension and there are no available intercom appearances to terminate the call, the call will continue to alert at the transfer destination until the transfer return extension becomes available.

The default value for each transfer return extension is its own extension.

---

## Unique Line Ringing / Override Line Ringing

This feature allows users to differentiate by sound which line is ringing by assigning a ring pattern to it. Once a ring pattern is assigned to a line, incoming calls on that line ring with the assigned ring pattern.

- Eight ring patterns are available.
- Unique Line Ringing does not apply to DID calls because the channel used is not guaranteed.
- The default is pattern 1.

If the Override Line Ringing feature is active, then incoming calls on a line that ring at an extension ring with the configured extension ring pattern.



---

## Visual Voice Messaging

Supported on 1400 and 9500 digital telephones only. Allows the user to manage their voice mail messages via their display. Features supported include:

- access new /old / saved messages.
- next and previous message.
- fast forward and rewind.
- pause message.
- save, delete and copy message to other users of the system.
- change default greeting.
- change password.
- change message status from old / saved to New.

---

## Voicemail Options

- **Bypass Greeting**
  - After a call goes to an extension's voice mailbox, the caller can press the 1 key to bypass the mailbox greeting and begin recording a message.
- **Change Message Status to New (\*06)**
  - This feature provides the ability to change the status of a message from *Old* or *Saved* to *New*.
  - Users can dial \*06 at any time after the *Old* or *Saved* message begins to play through the 3 second pause after the caller information portion of the message.
    - The message is moved to the queue of New messages.
  - When a message is marked as *New*, the system does not initiate a new Voicemail to Email message, but the extension's message waiting light is illuminated.
- **Choice of Language**
  - Each Auto Attendant can have a primary language assigned to it. The language applies to the pre-recorded prompts available to that Auto Attendant. This overrides the system language setting.
  - The per-extension Display Language setting will also override the system language and change all the displays, pre-recorded greetings, and prompts to the chosen language.
- **End of Recording options**
  - When a caller has finished leaving a message in an extension's mailbox, the caller can touch the # key to signal the end of recording of the message.
  - If the message is less than 3 seconds, the system will play the following prompt: "Message too short. Deleted. Goodbye."
  - If the message is longer than 3 seconds, the system will play the following prompt: "Your message has been sent. Goodbye."
- **Outcalling Notification**
  - If you use the Outcalling option, Embedded Voicemail will call the number which you have programmed to signal that a new message has arrived in your mailbox.
    - Each user can have 1 number programmed for outcalling notification.
    - The system will make up to 3 attempts (in 5-minute intervals) to contact the user.
    - After 3 attempts, outcalling notification will cease until another new voice message arrives.
- **Phantom Mailboxes**
  - Provides voice mailbox support for all extensions (10-57), without requiring the physical hardware to be present. Extensions without hardware are called *phantom extensions*.
    - **Note:** Ports 7 and 8 of an ETR-6 module can be used for phantom extensions even though you cannot plug a phone into them.
  - Calls to a phantom extension go directly to voice mail.
    - DTMF breakout service can be used to transfer the call.
  - Phantom voice mailboxes:

- Default like a normal mailbox.
- Can be accessed remotely if the remote access feature of the mailbox is enabled.
- Voicemail to Email can be activated for a phantom mailbox via the Simplified Manager.

---

## VMS Cover

Allows you to turn VMS Cover on and off, routing unanswered intercom and transferred calls for users' extensions to the Call Answer Service of the voice messaging system after the specified number of rings.

---

## VMS Cover Ring Interval

Allows you to define the number of times a call rings before it is sent to a user's voice mailbox.

---

## VMS Hunt Delay

Allows you to determine when outside calls should be answered by the Automated Attendant of the voice messaging system. You can set the system for any number of rings, 0–6. Assigning more rings gives the operator an opportunity to answer calls before they go to the Automated Attendant.

VMS Hunt Delay is programmable on a per-line basis. In addition, you can program this feature so that calls can be handled one way during the day and a different way when the system is in Night Service.

---

## VMS Hunt Schedule Interval

Allows you to determine when outside lines are covered by the Automated Attendant. Options include all the time, only during Day operation (Night Service is off), or only during Night operation (Night Service is on).

---

## Voice Mailbox Transfer - Direct

Allows you to transfer a call directly into a user's voice mailbox without ringing their extension.

---

## Voice Messaging

The system has Embedded Voicemail included as standard. All extensions are automatically assigned a mailbox.

Embedded Voicemail also provides:

- A 2-port, single level Automated Attendant
- Separate Morning, Afternoon, Evening and Out of Hours menu greetings with time profiles
- Dial by Name capability
- Variable hours of storage:
  - 2-ports = 15 Hours
  - 4-ports = 20 Hours
  - 6-ports = 25 Hours
- Up to three minutes per message
- Fast Forward, Rewind, Replay and Skip capability
- Voicemail to e-mail capability
- Remote message retrieval
- Visual Messaging (on digital telephones only)

---

## Wake-Up Service

This feature allows a system phone (x10) to set a Wake-up Call on behalf of another user.

- When a Wake-up Call is scheduled, the system will place an intercom call to the target extension at the scheduled time.
  - Wake Up calls ring for approximately 30 seconds (and overrides DND).
  - If the target extension is busy on a call or has an alerting call, the Wake Up call is delivered to the phone as an intercom call.
  - If the Wake Up call is answered, the user will hear Music On Hold if it is active; otherwise, they will hear silence.
  - If the Wake Up call is not answered, the system will make a 2<sup>nd</sup> attempt 5 minutes later.
    - If the call is not answered after the 2<sup>nd</sup> attempt, then the Wake Up call is abandoned.
  - A scheduled Wake Up call occurs once in a 24 hour period.

# Chapter 4.

# IP Office Server Edition

# 4. IP Office Server Edition

## Mid-market Overview

The term 'mid-market' refers to midsize enterprise companies with 250 to 1000 users. The total addressable market is about a ~\$2.5B market on the products side and an additional \$4.6B for services.

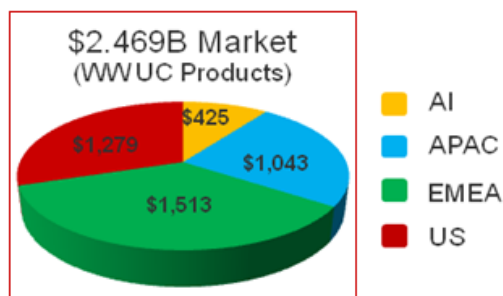

Source: RDA June 2011

## IP Office Solution Overview

IP Office Server Edition has been specifically designed to address up to a 1000 users on a single site and also to accommodate companies with up to a 1000 users across 32 locations.

The top two requirements that the majority of the mid-sized enterprise customers are looking for in their unified communications solutions are Total Cost of Ownership (TCO) and simplicity. IP Office showcases the best TCO advantage compared to the competition, including one of the simplest solutions to deploy and manage.

### Differences Between IP Office Server Edition and IP Office Preferred/Advanced Edition

Feature	Preferred/Advanced Edition	Server Edition	Server Edition Comments
<b>Capacity</b>	32 locations 1000 users total 7200 BHCC	32 locations 1000 users total 14400 BHCC (Max)	
<b>Multi-Site (SCN)</b>	Freeform Star, mesh, chain SCN trunks anywhere SCN trunk channels licensed	Single or double star No additional SCN trunks Unlimited SCN trunk channel licenses	Restricted topology allows many optimizations Other H.323 trunk types still allowed
<b>Administration</b>	Limited centralized (Multi-site (SCN) Manager)	Fully centralized (Server Edition Manager)	Consolidated mode for full centralization. Non-consolidated mode for freeform per device configuration
<b>Licensing</b>	Distributed	Central pool	All common licenses centralized. Some still distributed (See section 6.6.4 for a complete list) All administered centrally
<b>User Profile Licenses</b>	Telecommuter Mobile Worker Office Worker Power User	Office Worker Power User	
<b>O/G Call Routing</b>	no default assistance	Simplified	SE Manager and default routes allow simpler O/G call routing
<b>I/C Call Routing</b>	no default assistance	Simplified	Common ICRs allow simpler I/C call routing and resilience

<b>Time</b>	Freeform	Simplified by default, can still be freeform	Primary Server acts as solution time server by default
<b>System directory</b>	Freeform	Simplified by default, can still be freeform	Primary Server acts as solution directory server by default
<b>Fax transport</b>	IP Office T.38 fax transport	G.711 fax transport	No need to configure codec sets to enforce; G.711 fax transport used automatically
<b>SIP Trunk Direct Media to remote device across SCN</b>	None	Direct media supported to remote H.323 and IP DECT endpoints	Includes SIP Info and RFC 2833 support
<b>Hunt Groups</b>	Freeform	Hunt groups only on primary	Performance optimized for VMPro location (also on Primary) Automatic resilience when secondary present Overcomes SoftConsole limitations
<b>SoftConsole</b>	Up to 4 per IP Office	Up to 10 on Primary	Overcomes SoftConsole IP connectivity and SCN limitations
<b>Add/remove device</b>	Manual	Integrated via SE Manager	Auto population of Multi-Site links and common configuration
<b>Device Status/connectivity</b>	Not checked	Access and interconnects checked by SE Manager	Immediate indication if device offline or incorrectly networked
<b>IP Office Initial configuration</b>	Manual	Automated with Initial Configuration Utility (ICU)	Remote install technician without IP Office knowledge
<b>Upgrades</b>	Individual	Centralized	
<b>Backup/restore</b>	Individual per IP Office and per application	Centralized	Security settings not backed up
<b>Embedded VM/AA</b>	Supported	Not supported	Central VMPro only
<b>Voicemail Pro Ports</b>	40	100	Additional VMPro ports (up-to 100 Max) can be added on Secondary server for resiliency
<b>Voicemail Pro VRL, VRLA, VBA, Database access</b>	Supported on Windows VMPro server	Not supported	
<b>CCR</b>	Supported	Not supported	Use DevConnect Solutions for Call Center/Contact Center/Call Reporting applications
<b>Software distribution</b>	Admin DVD + Apps DVD	Single ISO distribution	
<b>Software Only Solution</b>	No	Yes (Controlled introduction at present)	
<b>Single management portal</b>	No	Yes	

## Differences Between IP Office Server Edition Multi-Site Solution and IP Office Legacy SCN Multi-Site Solution

Feature	IPO SCN	Server Edition Multi-Site	Server Edition Comments
<b>Topology</b>	Freeform Star, mesh, chain SCN trunks anywhere.	Single or double star. No additional SCN trunks	Restricted topology allows many optimizations. Other H.323 trunk types still allowed
<b>Administration</b>	Limited centralized (SCN Manager)	Fully centralized (Server Edition Manager)	Consolidated mode for full centralization. Non-consolidated mode for freeform per device configuration
<b>Licensing</b>	Distributed	Central pool	All common licenses centralized Some still distributed All administered centrally
<b>SSL VPN</b>	Separate independent access	Integrated access via Server Edition (SE) Manager	Allows remote solution management behind Services VPN Gateway
<b>O/G Call Routing</b>	Complex, no default assistance	Simplified	SE Manager and default routes allow simpler O/G call routing
<b>I/C Call Routing</b>	Complex, no default assistance	Simplified	Common ICRs allow simpler I/C call routing and resilience
<b>Time</b>	Freeform/complex	Simplified by default, can still be freeform	Primary Server acts as solution time server by default
<b>System directory</b>	Freeform/complex	Simplified by default, can still be freeform	Primary Server acts as solution directory server by default
<b>Fax transport</b>	IP Office T.38 fax transport across SCN	G.711 fax transport across SCN	No need to configure codec sets to enforce; G.711 fax transport used automatically
<b>SIP Trunk Direct Media to remote device across SCN</b>	None	Direct media supported to remote H.323 and IP DECT endpoints	Includes SIP Info and RFC 2833 support
<b>Phone Resilience Admin</b>	Freeform/complex	Simplified	SE Manager admin allows only Primary and/or Secondary to act as phone backup server
<b>Hunt Groups</b>	Freeform	Hunt groups only on primary	Performance optimized for VMPro location (also on Primary) Automatic resilience when secondary present Overcomes SoftConsole limitations
<b>SoftConsole</b>	Up to 4 per IP Office	Up to 10 on Primary	Overcomes SoftConsole IP connectivity and SCN limitations
<b>IP Phones with no default user</b>	Not resilient	Resilient	Allows hot desk phones to be resilient
<b>Add/remove node</b>	Manual	Integrated via SE Manager	Auto population of Multi-Site links and common configuration
<b>Offline device</b>	Cannot be managed	Managed via SE Manager	Includes online/offline synchronization

<b>Device Status/ connectivity</b>	Not checked	Access and interconnects checked by SE Manager	Immediate indication if device offline or incorrectly networked
<b>SCN trunk channels</b>	Limited by licenses	Unlimited	No multi-networking license required
<b>IP Office Initial configuration</b>	Manual	Automated with Initial Configuration Utility (ICU)	Remote install technician without IP Office knowledge
<b>Upgrades</b>	Individual	Centralized	Upgrades to all remote nodes can be performed from Primary Location
<b>Backup/restore</b>	Individual per IP Office and per application	Centralized	Security settings not backed up



# IP Office Key Components

IP Office address Mid-market via three key components:

1. IP Office software running on a Linux server (required).
2. IP Office software running on the IP500v2 (optional).
3. IP Office Server Edition license (required for each component).

**Note:** The IP500v1 chassis is not supported with IP Office Server Edition.

The software running on both the Linux server and the IP Office 500v2 is identical and hence the feature set delivered by the two components are the same (except those listed below) and co-exist as part of a single solution.

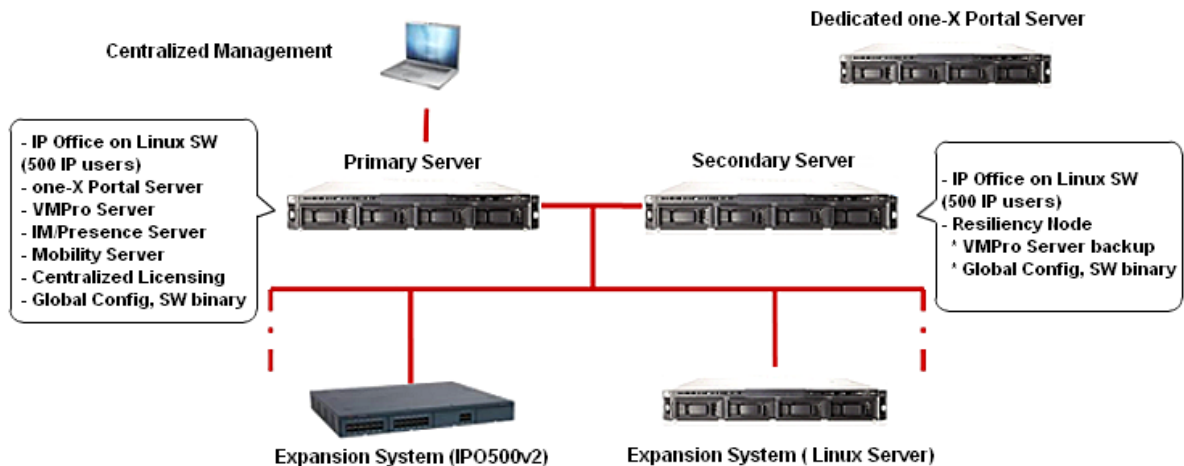

The Primary Server running the Avaya IP Office Release 8.1+ Server Edition Linux software is the main server and the only mandatory component required for the IP Office Mid-market offer to work. A secondary Linux server can be added for additional scalability and/or resiliency. The IP Office 500v2 expansion system can also be added for additional scalability or for adding support for analog/digital stations and trunk ports.

Following are the server models that Avaya will source:

Model #	Order Code	Description	Application	RAM	CPU	Power Supply	RAID
HP DL360G7	270393	DL360G7 SRVR IPO R8.1+SE PRIMARY	Primary or Secondary	12 GB	Dual Quad-Core	Hot Swap	Yes
HP DL120G6	270395	DL120G7 SRVR IPO R8.1+SE EXP	Primary or Secondary	12 GB	Single Quad-Core	Single	N/A

## IP Office Deployment Options

Increasingly, companies have started adopting a pure IP model with SIP trunking. However, many companies still prefer a hybrid solution with a mix of analog, digital, and IP stations, as well as TDM trunking options.

IP Office has been designed with these different solution requirements for different customer needs in mind. The flexibility and variety of the deployment options make the IP Office solution a very versatile solution and caters to different product needs.

There are two deployment scenarios for IP Office:

### 1. Server Edition with pure IP deployment:

- All IP phones with SIP trunking everywhere
- Use Avaya-sourced server for Applications, IP phones, and SIP trunks

### 2. Server Edition with hybrid deployment:

- A mix of Analog, Digital, or IP phones everywhere
- Use Avaya-sourced server for Applications, IP phones, and SIP trunks
- Use IP500v2 for TDM stations and trunking

## Avaya Server, All IP

## Avaya Server, Hybrid



## IP Office Scalability

IP Office is designed to scale up to support a 1000 users on a single site or across a maximum of 32 sites. The table below lists the servers and server capacities.

	Primary Server	Secondary Server	IP500v2 Expansion System	Linux Expansion System	Dedicated 1X Portal Server	Comments
<b>Avaya Tested and Sourced</b>	HP DL 360 G7 HP DL120 G7	HP DL 360 G7 HP DL 120 G7	IP 500 v2	HP DL 120 G7	HP DL 120 G7	HP Servers tested and sourced by Avaya
<b>Avaya Tested but NOT Sourced</b>	Dell R610	Dell R610	N/A	Dell R210	Dell R210	Dell servers tested by Avaya
<b>User Scalability</b>	DL360: 500 DL120: 250	DL360: 500 DL120: 250	384	500	N/A	
<b>1x Portal Scalability</b>	DL360: 200 DL120: 100	N/A	N/A	N/A	500	
<b>VMP Pro Port Scalability</b>	DL360: 100 DL120: 40	DL360: 100 DL120: 40	N/A	N/A	N/A	Centralized deployment only with voicemail resiliency on secondary.
<b>Receptionists</b>	10	N/A	N/A	N/A	N/A	
<b>Conference Channels</b>	128			128		
<b>SIP/H.323 Trunks</b>	DL360: 250 DL120: 125	DL360: 250 DL120: 125	125	125	N/A	
<b>Phones</b>	DL360: 500 IP Phones DL120: 250 IP Phones	DL360: 500 IP Phones DL120: 250 IP Phones	384 Analog, Digital, H.323, or SIP IP-DECT* or Wi-Fi	500	N/A	* 120 IP DECT endpoints maximum **Avaya 16xx/96xx H.323 endpoints only
<b>VCM Channels</b>	N/A	N/A	148	N/A	N/A	G.711, G729, G.723, G.722, T.38

## IP Office Resiliency

IP Office resiliency can be divided into three distinct categories. The primary server and secondary server can each support up-to 1000 users in Resilience mode.

**Note:** The Primary and Secondary servers can be C-located or can be on separate locations to support Geo-Redundancy.

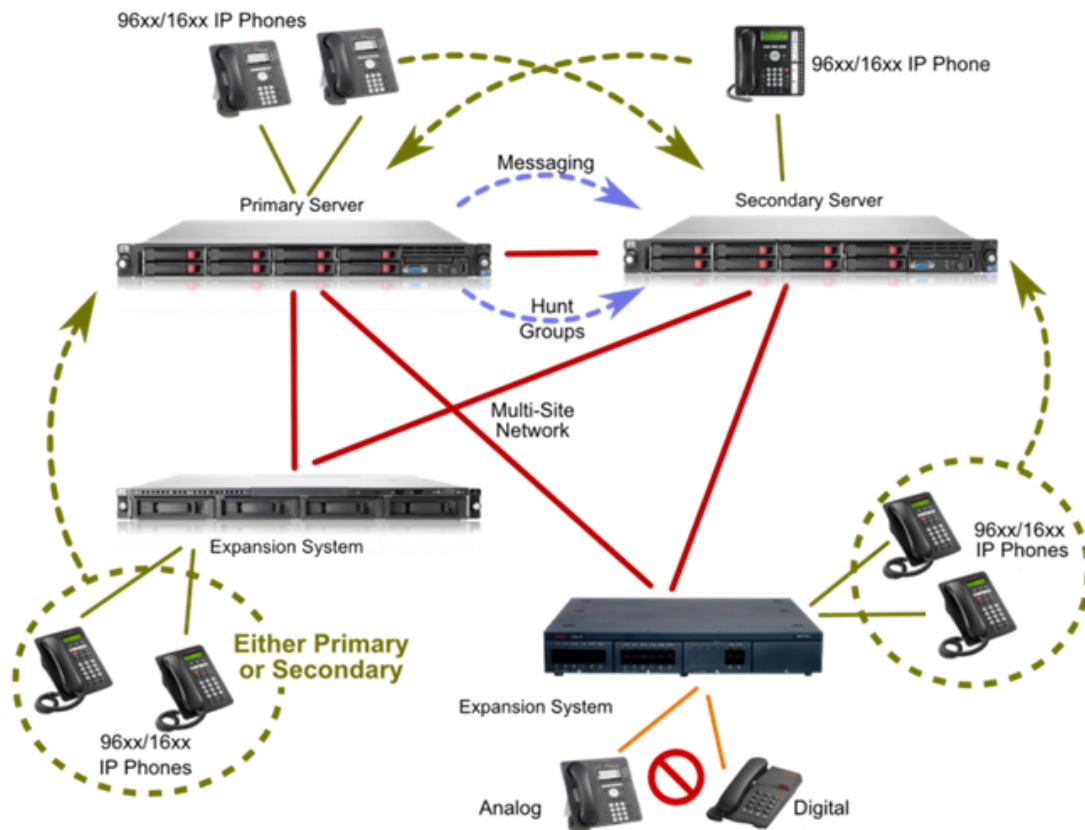

### 1. Hardware Resiliency

- RAID support
- Dual PSU on Avaya sourced HP DL360 G7

### 2. Users and Application Resiliency

- VMPro server – Primary + Backup in 1+1 redundant active/passive configuration. Manual or auto-failback control (auto-failback is new for Release 8.1)
- IP Phones – 1:1 resiliency to backup IP Office. Manual failback control (Phone reset). Avaya H.323 phones only.  
**Note:** Expansion systems (gateways) cannot act as backup nodes for the Linux Servers.
- Hunt groups - 1:1 resiliency to backup Server. Auto-failback control (device rediscovery – idle group).
- Inter IP Office device links – Multi-Site Network (SCN) backup. Double star. 1:1 resiliency. Auto-failback control (device rediscovery)
- Inter IP Office device links – PSTN backup. M:N resiliency via Alternate Route Selection (ARS). Auto-failback control (link availability)
- Trunks – M:N resiliency via ARS. Auto-failback control (trunk availability)
- Incoming Call Routes – Incoming Call Routes are common to all devices hence persist on user failover

### 3. Trunk Resiliency

- PSTN Back-up

## IP Office Centralized Licensing

IP Office Server Edition supports centralized licensing. All the user-specific and system-specific licenses can be managed from the Primary Server that also acts as the centralized licensing server.

### New Licenses

The only new license for the IP Office is the new system software license called Server Edition. The feature Key Serial Number (System ID) is derived from platform hardware.

License Name	Order Code	License Type	License Description	Comments
<b>Server Edition</b>	270397	System SW	IPO R8.1+ SERVER EDITION LIC	<p>Required per node (Linux server or IP500v2)</p> <p>Bundles in:</p> <ol style="list-style-type: none"> <li>1. Features from Essential Edition</li> <li>2. Features from Preferred Edition</li> <li>3. Centralized VMPro</li> <li>4. Two (2) ports of VMPro</li> <li>5. Unlimited SCN(multisite networking) channels</li> </ol> <p>Enables meet-me conferencing, advanced messaging, automated attendant, call recording, conditional call routing, queue announcements, mobile twinning, call control and call-back.</p> <p><b>Note:</b> Advanced Edition is not supported on Server Edition.</p>

### IP Office Centrally Residing Licenses

- Server Edition (includes aggregation of VMPro ports from all nodes)
- Avaya and 3rd-party Endpoints
- SIP trunk channels
- Office Worker
- Power User
- Receptionist (for SoftConsole)
- UMS Web Services (for hunt groups)

### IP Office Locally Residing Licenses

License Name	Primary Server	Secondary Server	IP500v2
<b>Additional PRI Channels</b>			✓
<b>IPSec Tunnelling</b>			✓
<b>CTI Link Pro</b>		✓	✓
<b>TAPI Wav</b>			✓
<b>Additional Messaging Ports</b>	✓	✓	
<b>Messaging TTS Pro</b>	✓	✓	
<b>Messaging Recordings Administrators</b>	✓	✓	

**Notes:**

- All locally residing licenses are still managed centrally using the Manager tool.
- The Locally residing licenses need to be provisioned separately based on the table above.
- For Voicemail resiliency, separate VMPro Ports on the Secondary Server are required to support more than the two (2) default ports.

### Voice Compression Module (VCM) v2

The current versions of the VCM32 and VCM64 modules include 12 IP endpoint licenses.

The new VCM32v2 and VCM64v2 does not include the 12 IP endpoint licenses. This allows all IP endpoint licenses to be centrally managed by the server edition.

Material Code	Description
700504031	VCM 32 V2 NEW
700504032	VCM 64 V2 NEW

### Using VCM32v1 and VCM64v1 with R8.1

1. With SME editions
  - The VCMs will work as-is and will include 12 IP endpoint licenses.
2. With Server edition
  - The 12 IP Endpoint licenses will be included locally on the IP500v2 expansion systems. These 12 IP endpoint licenses will not be available on the primary server for centralized management. These licenses will need to be managed locally.

### Using VCM32v2 and VCM64v2 with R8.1

1. With SME editions
  - The VCMs will work as-is and will NOT include 12 IP endpoint licenses.
2. With Server edition
  - The VCMs will work as-is and will NOT include 12 IP endpoint licenses.

### Using VCM32v1 and VCM64v1 with R8.0

- No change.

### Using VCM32v2 and VCM64v2 with R8.0 or earlier

- A service pack will be required for the SW to recognize the v2 versions of the card.

---

## IP Office Server Edition Unsupported Licenses

The following is a list of licenses that are not applicable or supported with IP Office Server Edition.

- Advanced Edition-CCR Agent and Supervisor (CCR not yet supported on Server Edition)
- Teleworker, Mobile Worker, and Avaya Softphone licenses
- Embedded Messaging Ports (Embedded messaging not supported on Server Edition)
- VMPro TTS (Generic/Scansoft), Networked Messaging, Database interface, VB Script (Not supported on VMPro for Linux)
- All Avaya Office Aura Edition (B5800) licenses
- Various legacy licenses (CCC, Phone Manager, VCM channels, Mobility)

# IP Office Centralized Management

The IP Office Server Edition management framework includes a Web Control GUI that acts as key element for centralized management and provides solution-wide status and control. From this control GUI page, installers can manage and control the different Linux sub-systems and various global controls like back-up and restore, software upgrades, inventory management, and more.

This web control GUI also acts as a central repository for other management tools including IP Office Manager, VMPro Manager, one-X Portal Manager, SSA, and system monitor, as well as security, password, and inventory management.

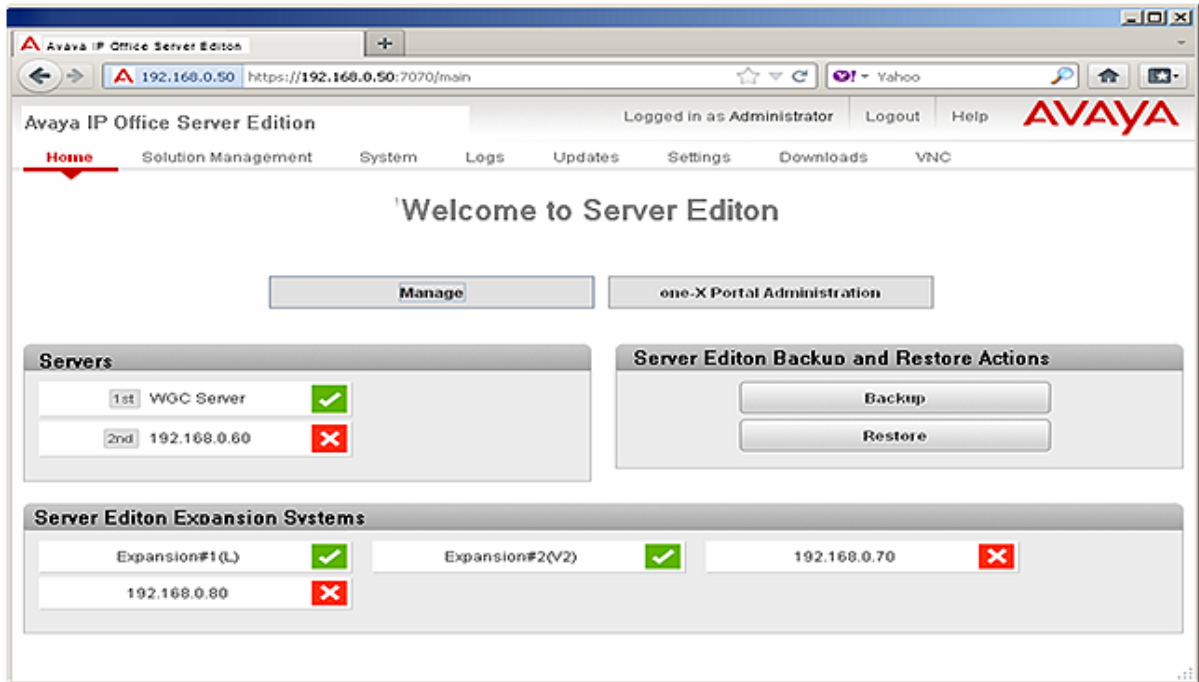

The IP Office Manager can be launched directly from the web control GUI. If the manager tool does not exist, the web control GUI automatically downloads and installs the latest version of the manager tool.

The following PBX functions are solution-wide at a multi-site level:

- Users
- Hunt Groups
- Short Codes
- Incoming Call Routes
- Directory
- Time Profiles
- Account Codes
- User Rights

## Templates

Several templates are supported and can be created from the IP Office Manager in the Server Edition mode:

- Line, User
- Extension
- Hunt Group
- Time Profile
- Firewall
- IP Route
- ARS entries

**Note:** IP Office Manager supports both online as well as offline configuration modes.

## Backup and Restore

IP Office Server Edition has several backup and restore options:

- Automated 24 hour local backup of firmware, configuration, and security settings (not Linux packages)
- Manual backup/restore commands from Phone, SSA, Manager
- Automated use of backup copy on restart errors
- IP Office Manager for Server Edition saves a complete set of configuration files on Primary Server and can optionally save to local PC directory

- VMPro and one-X Portal can be administered to save periodic backup sets on the Primary Server (manual or automatic)
- Primary Server has manual Backup/Restore commands on Web Control that copies all backup file sets
  - No automated options
  - No application packages

---

## Installation and Upgrades

License Name	Order Code	License Type	License Description	Comments
<b>Installation DVD</b>	700503228	System SW DVD	IPO R8.1 SERVER EDITION INSTL DVD	

1. A single distribution contains the software components for the whole solution, which includes the server and user applications, as well as phone and Avaya Office 500 firmware.
2. Avaya servers come with distribution pre-installed.
3. Linux servers support a web based 'Ignition' process to personalize them for their intended use:
  - a. Primary
  - b. Secondary
  - c. Linux Expansion
  - d. one-X Portal server
4. A simple, single screen utility (Initial Configuration Utility) is run automatically to allow an Avaya Office device to be centrally-detected and administered as part of the solution.
5. Upgrades are automated, solution-wide, and centrally-managed.

---

## Ignition Process

The IP Office Ignition process involves using a simple utility to seamlessly add/install expansion systems such that they can become part of a single logical Server Edition multisite network. This utility is designed for installers who lack detailed IP Office knowledge. The installer needs to know some basic LAN and Primary/Secondary Server information and must pre-populate most fields with existing data.

Much of the configuration is handled behind the scenes and includes security settings, multi-site networking (SCN) trunks, users, extensions, voicemail, directory, time, ARS, short codes, etc.

---

## Documentation, Training, and Localization

---

### Documentation

IP Office documentation will be available in the following languages:

- US English
- French
- LA Spanish
- German
- Italian

---

### Training

A four (4) hour web-based training activity will be available that covers the IP Office Mid-market content for Release 8.1. Training will be available in English only.

## Localization

Application		EFIGS	Other (see language codes below)
<b>CCR</b>	GUI	✓	RUS, PTB, NLD
	Installer	✓	RUS, PTB
	Admin docs	✓	RUS
	User docs	✓	RUS, PTB
<b>Manager</b>	GUI	✓	Simp CH, PTB, NLD
	Admin docs	✓	Simp CH, RUS, PTB
	Install docs	✓	Simp CH, RUS
<b>Quick Manager</b>	Install docs	✓	RUS
<b>Video Softphone</b>	GUI	✓	Simp CH, RUS, PTB, JPN, NLD
	User doc	✓	Simp CH, PTB
	Install doc	✓	RUS
<b>one-X Portal</b>	GUI	✓	Simp CH, RUS, PTB, NLD
	Docs	✓	Simp CH, RUS, PTB, NLD
<b>SSA</b>	GUI	✓	Simp CH, PTB, NLD
	Admin doc	✓	Simp CH, RUS, PTB, JPN
<b>VmPRO</b>	GUI	✓	Simp CH, RUS, PTB, KOR, NLD, DAN, FIN, NOR, PTG, ESP, SVE
	Prompts	✓	Simp CH, RUS, PTB, KOR, NLD, DAN, FIN, ELL, HUN, NOR, PLK, PTG, ESP, SVE
	Admin Doc	✓	RUS
	User Doc	*ESLA	Simp CH
<b>Embedded Voicemail</b>	Prompts	✓	Simp CH, RUS, PTB, KOR, NLD, DAN, FIN, NOR, PTG, ESP, SVE
	Docs	✓	--
<b>Phones</b>	GUI	✓	Simp CH, RUS, PTB, NLD, DAN, FIN, NOR, PTG, ESP, SVE
	9500 doc	✓	Simp CH, RUS, PTB
	BST doc	✓	--
	B100 doc	✓	PTB
	4600/5600 doc	E, Fr	Simp CH, NLD
	1100/1200 doc	✓	PTB
	1600 doc	✓	Simp CH, RUS
<b>Softconsole</b>	GUI	✓	Simp CH, RUS, PTB, KOR, NLD, DAN, FIN, NOR, PTG, ESP, SVE
	Docs	E, Fr	Simp CH, RUS



**\*Localization table language codes:**

- **EFIGS:** US English, French, Italian, German, LA Spanish
- **Simp CH:** Simplified Chinese
- **RUS:** Russian
- **PTB:** Brazilian Portuguese
- **KOR:** Korean
- **JPN:** Japanese
- **NLD:** Netherlands
- **DAN:** Denmark
- **FIN:** Finland
- **ELL:** Greece
- **HUN:** Hungary
- **NOR:** Norway
- **PLK:** Poland
- **PTG:** Portuguese
- **ESP:** Spanish
- **SVE:** Swedish

---

## Serviceability

---

IP Office supports serviceability via SSL/VPN technology. The SSL/VPN client is embedded in the IP Office software (both for IP500v2 and Linux). The server side is the Avaya VPN Gateway (AVG). AVG is virtualized software can be loaded on any server (see server hardware requirements).

**Note:** Please refer to [SSL/VPN Remote Access](#)<sup>[295]</sup> for more details on Serviceability.

# **Chapter 5.**

# **IP Office 500 Platform**

## 5. IP Office 500 Platform

IP Office is a modular communications solution that scales from 2 to 384 extensions on a single platform. IP Office supports up to 32 sites and 1000 users in a multi-site network with resilient and redundant capabilities. It provides a hybrid PBX with both Time Division Multiplexing (TDM) and IP telephone and trunk support that can be used in either mode or both concurrently. IP Office has data capabilities built in, providing IP routing, switching and firewall protection between LAN and WAN (LAN2). IP Office has a web based applications suite that delivers contact center reporting, voice and email messaging, Interactive Voice Response, conferencing and computer telephony integration.

IP Office solutions are built from hardware units and application software. Hardware provides the connectivity for voice and data circuits and processor units for the solution software. Each IP Office solution will require a system control unit (IP500 V2), trunk connections to service provider, and expansion modules for TDM telephone cabling. IP Telephones connect over LAN connections to the IP Office solution.

---

### IP Office 500 Control Unit

---

The IP500 V2 control unit is compatible with all IP500 base extension and Voice Compression Modules (VCM) cards as well as all external IP500 expansion modules.

IP500 V2 is a stackable unit with an optional 19" rack mounting kit and an optional wall mounting kit for smaller configurations. The control unit provides the following functionality:

- 4 slots to house a mixture of extension cards and VCM cards and the Unified Communications Module:
  - Digital Station 8 card. Supporting IP Office digital telephones
  - TCM8 Station card supporting select Nortel digital telephones (IP500 V2 control unit only)
  - Phone 2 and Phone 8 cards
  - VCM32 and VCM64 cards
  - 4-Port Expansion card
  - ETR6 port phone card (IP500 V2 only, North America only)
  - Combination Card with 10 VCM channels, 4 analog trunks, 6 Digital Station (DS) and 2 Phone ports (IP500 V2 only)
  - Combination Card with 10 VCM channels, 2 BRI trunk interfaces (4 channels), 6 Digital Station (DS) and 2 Phone ports (IP500 V2 only)
- Optional trunk card support:
  - Analog Trunk Module 4 card
  - BRI4 and BRI8 cards (2 x 2B+D and 4 x 2B+D channels respectively)
  - Single and Dual Universal PRI cards
  - IP500 Legacy Card Carrier: this card allows up to two IP400 Trunk or VCM Cards to be used with the IP500 control unit
  - IP500 V2: 2 Slots for SD cards (System and optional) – System SD card is required for system operation as well as licensing of optional features and storage for embedded voicemail in Essential Edition.
  - 9-pin RS232 DTE Port for maintenance.
  - Support for up to 12 IP500 Expansion Modules:
    - Phone modules (16, 30)
    - Digital Station modules (16, 30) supporting IP Office telephones with RJ45 connector
    - Digital Station modules (16A, 30A) supporting Nortel telephones with RJ21 connector (IP500 V2 control unit only)
    - Analog Trunk Module 16
    - IP500 So8 module
    - IP400 expansion modules (not WAN3 10/100 or Network Alchemy modules)
  - External output socket supporting two relay on/off switch ports, e.g. for door entry systems
  - Audio input port for external music on hold source

- 48 Data channels
- Up to 40 voicemail ports
- Two 10/100 switched Ethernet ports (Layer 3)

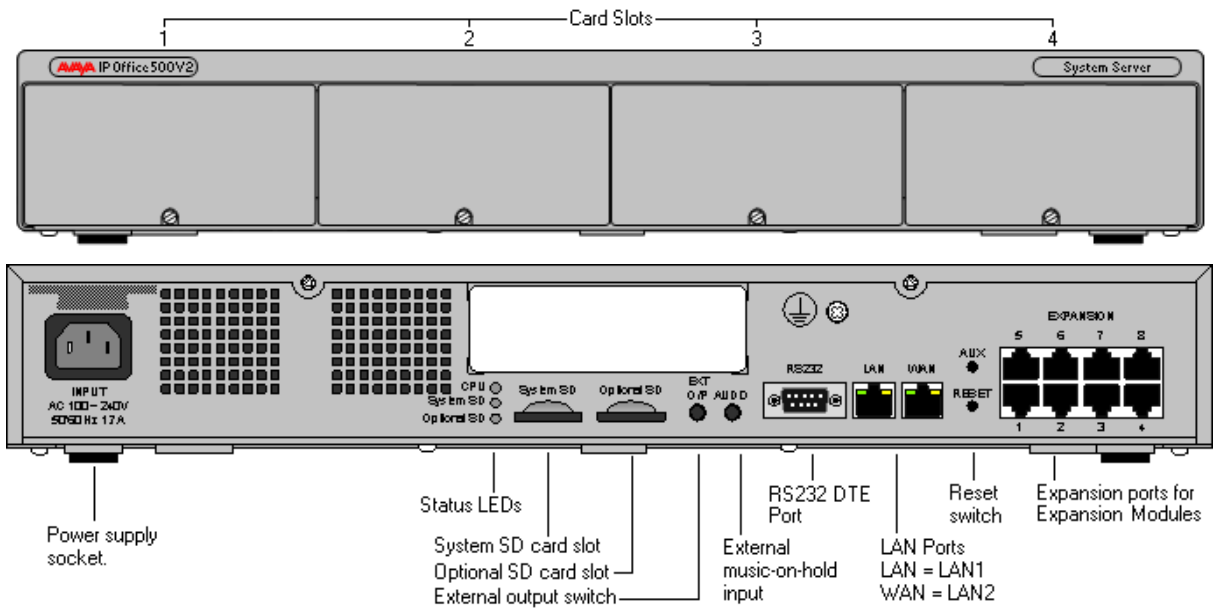

## IP500 Base Cards

The IP500 control unit has 4 slots for the insertion of cards. These cards can be divided into two types; base cards and trunk cards. Base cards include a front panel and ports for cable connections. Trunk cards can be added to a base card in order to provide additional facilities (typically trunk connections).

The following base cards are available:

- [IP500 Digital Station 8 Card](#)<sup>[94]</sup> (Maximum 3)
- [IP500 Digital TCM Station 8 Card](#)<sup>[94]</sup> (Maximum 4)
- [IP500 Analog Phone 2 Card and Phone 8 Card](#)<sup>[95]</sup> (Maximum 4)
- [IP500 VCM Card](#)<sup>[97]</sup> (Maximum 2)
- [IP500 4-Port Expansion Card](#)<sup>[97]</sup> (Maximum 1)
- [IP500 Legacy Card Carrier](#)<sup>[98]</sup> (Maximum 2)
- [ETR 6 Port Phone Card](#)<sup>[95]</sup> (Maximum 3, IP500 V2 only)
- [Combination Card with 4 Analog Trunks](#)<sup>[96]</sup> (Maximum 2, no trunk card, IP500 V2 only)
- [Combination Card with 2 BRI Trunks](#)<sup>[96]</sup> (Maximum 2, no trunk card, IP500 V2 only)

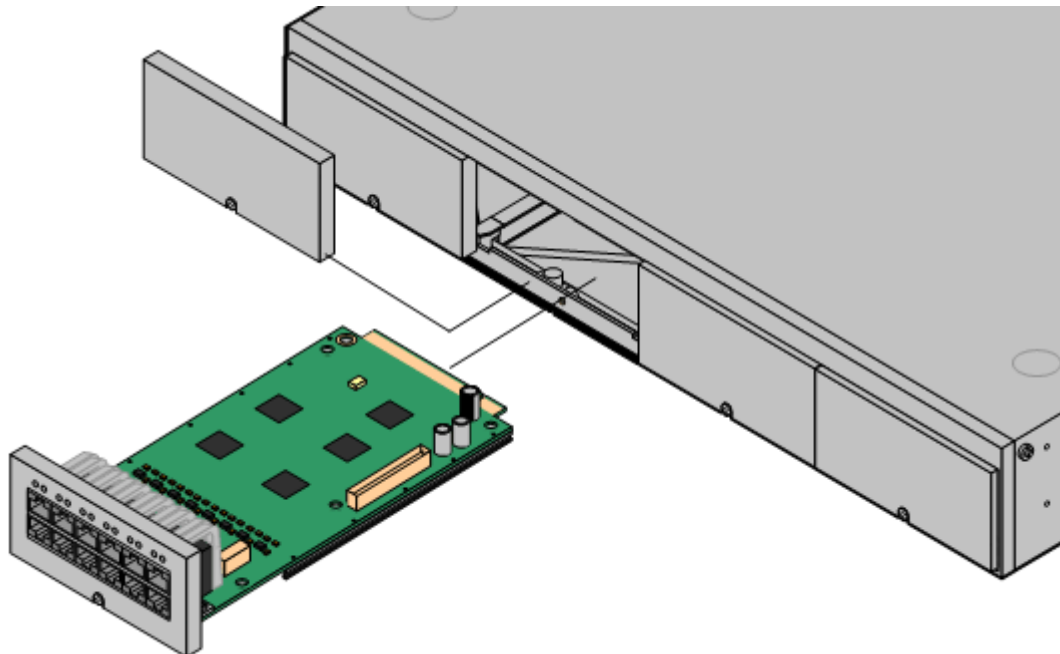

### IP500 Digital Station 8 Card

This card provides 12 RJ45 ports. The first 8 ports are DS ports for the connection of Avaya digital telephones other than IP telephones. The card can be fitted with an IP500 trunk card, which then uses the additional 4 RJ45 ports for trunk connections.

A variant of the digital station card, Digital Station TCM8, supports select Nortel digital telephones. Refer to the Telephone section for details.

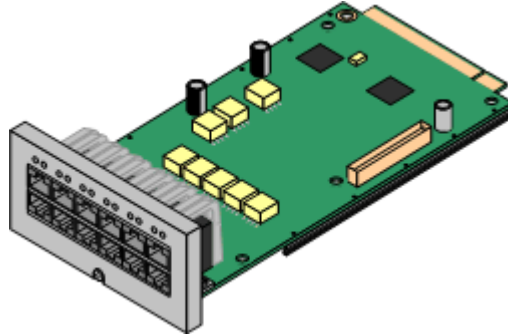

- This card accepts one IP500 trunk card of any type.
- This card supports selected Avaya 2400, 5400 and 9500 Series telephones, plus T3 telephones(EMEA only) and 3810 wireless telephones (North America only).
- 4400 Series telephones (4406D, 4412D and 4424D) are not supported on this card, only on Digital Station expansion modules. Therefore a maximum of 360 x 4400 Series telephones are supported in the system.
- 6400 Series telephones *are* supported but only if you are running pre-Release 7.0 in IP Office 'mode' (the phone will work after Release 7.0, but it will not be supported).

### IP500 Analog Phone 2 Card

This card provides 2 analog extension ports (1-2) for the connection of analog telephones. The card can be fitted with an IP500 trunk card, which then uses the last 4 RJ45 ports (9-12) for trunk connections.

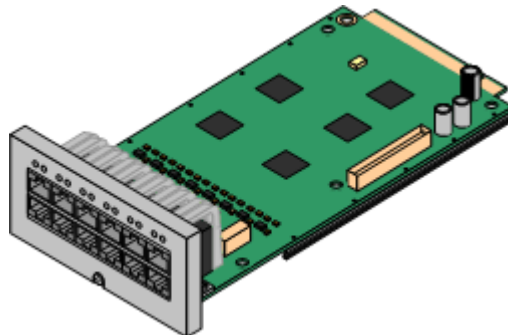

- This card accepts one IP500 trunk card of any type.

### IP500 Analog Phone 8 Card

This card provides 8 analog extension ports for the connection of analog telephones. The card can be fitted with an IP500 trunk card, which then uses the additional 4 RJ45 ports for trunk connections.

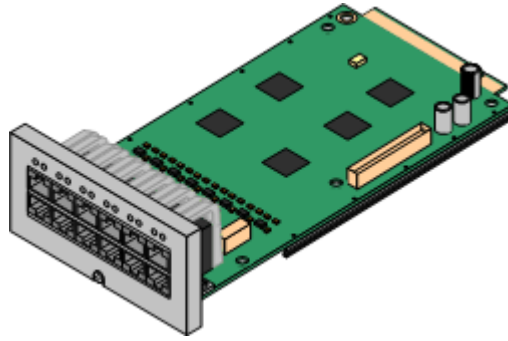

- This card accepts one IP500 trunk card of any type. When fitted with an Analog Trunk card, it provides a single power-fail port.

### IP500 ETR 6 port Phone Card

This card can be fitted with an IP500 trunk card, which then uses the additional 4 RJ45 ports for trunk connections. A maximum of three of these cards is allowed in the IP500 V2 control units.

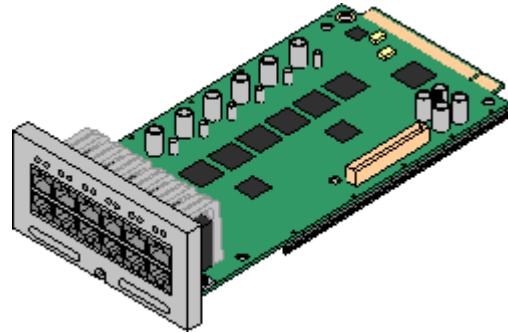

This card

- accepts one IP500 trunk card of any type. When fitted with an Analog Trunk card, it provides a single power-fail port.
- works in IP500 V2 only.
- is only supported by the [IP Office Basic Edition - PARTNER Mode](#) <sup>18</sup>.

### **IP500 Combination Card with 4 Analog Trunks**

This card works in the IP500 V2 only and provides:

- 4 Analog trunk ports.
- 2 Analog extension ports for the connection of analog telephones.
- 6 Digital Station (DS) ports for the connection of Avaya digital telephones.
- 10 VCM channels to support IP telephones or voice networking.

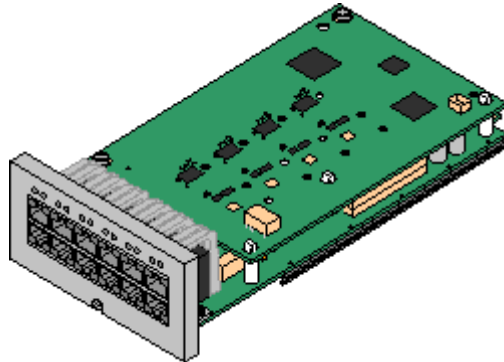

This card already includes an IP500 trunk card, therefore no additional trunk card is possible. It provides a single power-fail port (port 8). A maximum of two of these cards is allowed in the control unit.

### **IP500 Combination Card with 2 BRI trunks**

This card works in the IP500 V2 only and provides

- 2 BRI trunk ports (4 channels).
- 2 Analog extension ports for the connection of analog telephones.
- 6 Digital Station (DS) ports for the connection of Avaya digital telephones
- 10 VCM channels to support IP telephones or voice networking

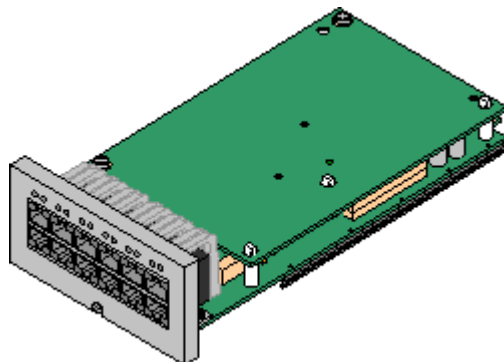

This card already includes an IP500 trunk card, therefore no additional trunk card is possible. A maximum of two of these cards is allowed in the chassis.



## IP500 VCM Card

This card provides voice compression channels for use with VoIP calls, SIP trunks and IP-based voice networking. The module is available in variants supporting 32 or 64 channels.

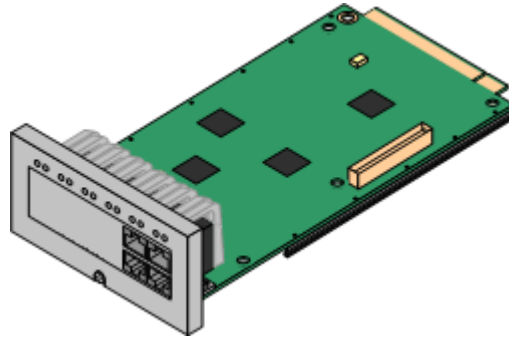

The maximum number of voice compression channels supported, using IP500 VCM base cards, Combination Cards and / or IP400 VCM cards on IP500 Legacy Card Carriers, is 148.

Please note, the maximum number of channels which may be used on each IP500 VCM card varies according to the codec used, as shown in the following table.

Maximum VCM channels available, by codec type:

	VCM 32 Card	VCM 64 Card	Combination Card
<b>G.711</b>	32	64	10
<b>G.729</b>	30	60	10
<b>G.723</b>	22	44	10
<b>G.722</b>	30	60	10

- This card accepts one IP500 trunk card of any type.

For more details about VCM channel requirements please refer to [IP Telephony](#) <sup>[254]</sup>.

## IP500 4-Port Expansion Card

- This card provides connectors for 4 additional expansion modules.
- The 4-port expansion card must be inserted in slot 4 of the control unit.
- It is not possible to connect a trunk card to the 4-port expansion card.

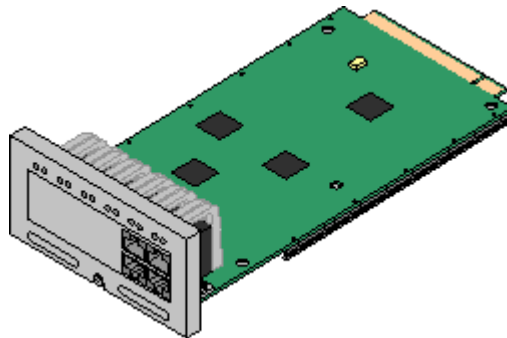

## IP500 Legacy Card Carrier

This card allows a variety of IP400 trunk or VCM cards to be used with the IP500 control unit. The front of the card includes a number of panels that can be snapped off to match the ports available when an IP400 trunk card is fitted.

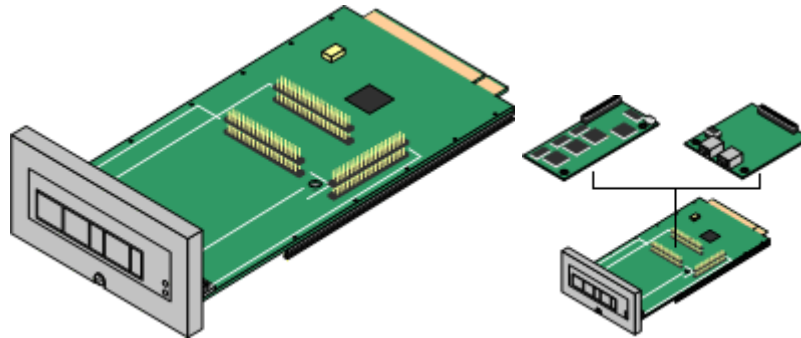

- This card does not accept any IP500 trunk cards.
- The IP500 control unit can accept up to 2 IP400 trunk or VCM cards by mounting each card on an IP500 Legacy Card Carrier
- This card supports the following IP400 cards:
  - ✓ PRI T1
  - ✓ Dual PRI T1
  - ✓ PRI 30 E1 (1.4)
  - ✓ Dual PRI E1
  - ✓ PRI 30 E1R2 RJ45
  - ✓ Dual PRI E1R2 RJ45
  - ✓ ANLG 4 UNI
  - ✓ BRI-8 (UNI)
  - ✓ VCM 4
  - ✓ VCM 8
  - ✓ VCM 16
  - ✓ VCM 24
  - ✓ VCM 30

---

## IP500 Trunk Cards

IP500 trunk cards can be fitted to existing IP500 base cards to provide support for trunk ports. The trunk card uses the ports provided on the base card for cable connection. The addition of an IP500 trunk card is supported on IP500 Digital Station, IP500 Analog Phone and IP500 VCM base cards. They are not supported on the IP500 Legacy Card Carrier base card.

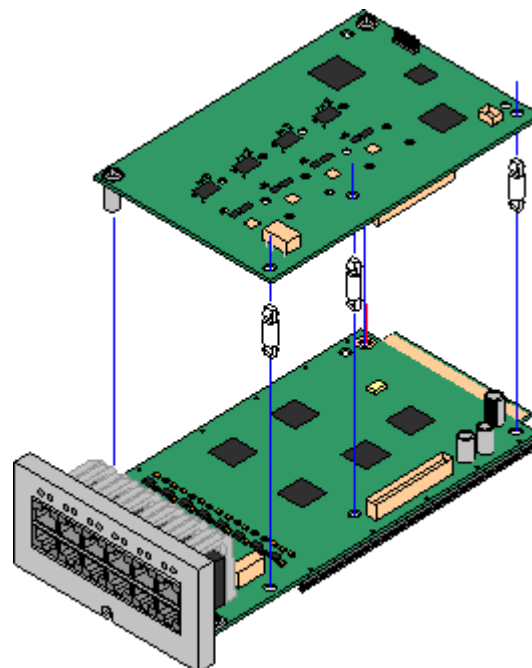

In systems with both Analog Phone 8 base cards and analog trunk cards, combining the two types are recommended as it then provides analog power failure support for one trunk/extension (not applicable to the Analog Phone 2 base card).

Each trunk card is supplied with the spacer pegs required for installation and a label to identify the card's presence on the physical unit once installed.

- IP500 Analog Trunk Card (Maximum 4).
- IP500 BRI Trunk Card (Maximum 4).
- IP500 Universal PRI Trunk Card (Maximum 4).

### IP500 Analog Trunk Card

This card can be added to an IP500 Digital Station card, IP500 Analog Phone base card, or IP500 VCM card. It allows that card to then also support 4 analog loop-start trunks. Only one analog V.32 modem is supported on a system.

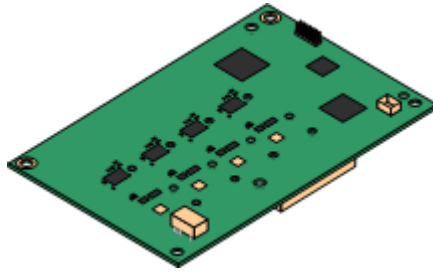

- When fitted to an IP500 Analog Phone 8 base card (not Phone 2), the combination supports 1 power failure extension to trunk connection.
- The card provides a V32 modem for remote access (only one per system)--supported on ETR and TCM cards.

### IP500 BRI Trunk Card (Euro ISDN)

This type of card can be added to an IP500 Digital Station card, IP500 Analog Phone card, TMC8 card or IP500 VCM card. It allows that card to then also support up to 4 BRI trunk connections, each trunk providing 2B+D digital channels. The card is available in 2 port (4 channels) and 4 port (8 channels) variants.

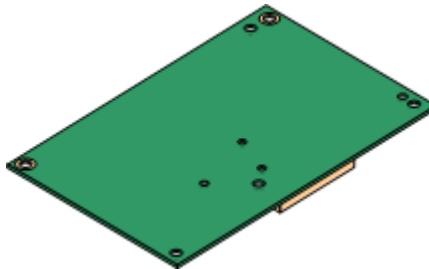

The ports on IP500 BRI cards can be individually configured to operate as an S-interface (S0 mode). When set as an S interface the settings for the Line will be exactly the same as for a circuit on an So8 Expansion Module.

- These trunks support the mobility features of [Mobile Call Control and one-X Mobile client](#)<sup>[236]</sup>.

## IP500 Universal PRI Trunk Card

This type of card can be added to an IP500 Digital Station card, IP500 Analog Phone card, TMC8 card or IP500 VCM card. It allows that card to then also support primary rate digital trunk connections. Available in single and dual versions the IP500 PRI card provides single and dual primary rate trunk interfaces respectively. The PRI is configurable for T1, E1 or E1R2 MFC use depending on the territory.

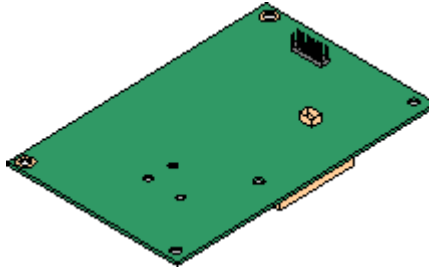

Details of the supported ISDN supplementary services and protocols for each PRI are given in the 'Public and Private Voice Networks' section.

The IP500 Universal PRI trunk cards incorporate an integrated CSU/DSU. The CSU function allows the trunk to be put in loop-back mode for testing purposes. This can be set manually, using the monitor application, or automatically from a Central Office sending a Line Loop Back (LLB) pattern. The DSU function allows the T1 trunk to be shared between data and voice services.

Here is a summary of the capabilities of the card:

- Each card is configurable to connect to T1, E1 or E1R2 lines.
- The card is available in either a single or dual PRI variant. The single variant can support up to 24 T1 channels or up to 30 E1 channels. The dual variant can support up to 48 T1 channels or 60 E1 channels.
- Support for ETR card
- On each card, 8 channels per interface are enabled by default. This means that the single PRI has 8 channels enabled, while the dual PRI has 16 channels enabled. Further channels may be enabled by the purchase of additional licenses in 2-channel or 8-channel increments.
- The IP500 PRI trunk card works on any IP500 VCM or extension base card (not the Legacy Card Carrier)
- Up to four Universal PRI cards can be installed in any combination in the IP500 or IP500 V2 control unit
- Diagnostics capabilities:
  - Visual indicators to show service state
  - Physical test points to monitor traffic.
- These trunks support the mobility features of [Mobile Call Control and one-X Mobile client](#) <sup>[236]</sup>.

---

## External Expansion Modules

---

Each of these modules may be used with the IP500

- [IP500 Phone Expansion Module](#)<sup>[102]</sup>  
Available in two variants for 16 or 30 analog extensions with calling line presentation.
- [IP500 Digital Station Expansion Module](#)<sup>[103]</sup>  
Available in two variants for 16 or 30 digital extensions for Avaya digital telephones or select Nortel digital telephones (Digital Station 16A and Digital Station 30A variants used with Nortel telephones with IP Office Release 7.0)
- [IP500 Analog Trunk 16 Expansion Module](#)<sup>[105]</sup> (US version only)  
Provides 16 analog loop start or ground start trunks, with power failover of two trunks.

---

## IP500 Analog Phone Expansion Module

The IP500 module provides additional analog telephone interfaces:

- Two Wire.
- DTMF signaling (No rotary or Loop Disconnect).
- Time Break Recall (No Earth Recall).
- Message Waiting Indication (MWI) capable - High Voltage, Pulsed High Voltage, Line Reversal.

IP Office Phone Modules provide support for a variety of analog MWI methods. These methods are 51V Stepped, 81V, 101V and Line Reversal.

Each analog port can support a device of maximum 1 REN.

On analog ports, call information is sent while the phone is ringing, and cannot be updated during a call or set on an outbound call (the phone may do a local match but this is not controlled by the IP Office). The primary purpose of displays is to give information about incoming calls. Where the Caller Display standard chosen supports the delivery of text (extension name) as well as the number, both are delivered.

An analog extension port can be set for external Paging operation. It does not operate like a normal extension and is connected to external equipment through an isolation device. The Port will always be busy so it cannot be called directly and can only be accessed by using a paging feature. When not receiving a Page, the port will remain silent. When being paged, the page tone is sent before the speech path is opened.

## IP500 Digital Station Modules

This expansion module provides additional Digital Station (DS) ports for selected Avaya 1400, 2400, 4400, 5400, 9500, 6400, T3 (EMEA only) Series telephones and 3810 wireless telephones (North America only). The IP500 Digital Station module is available in several variants; 16 or 30 extensions, supporting IP Office telephones with RJ45 connectors and supporting Nortel telephones with RJ21 connectors. Refer to the Telephone section for Nortel phone support.

For installations in a rack, this module requires the IP500 Rack Mounting Kit. The IP500 Digital Station Module is functionally identical to the IP400 Digital Station V2 Module.

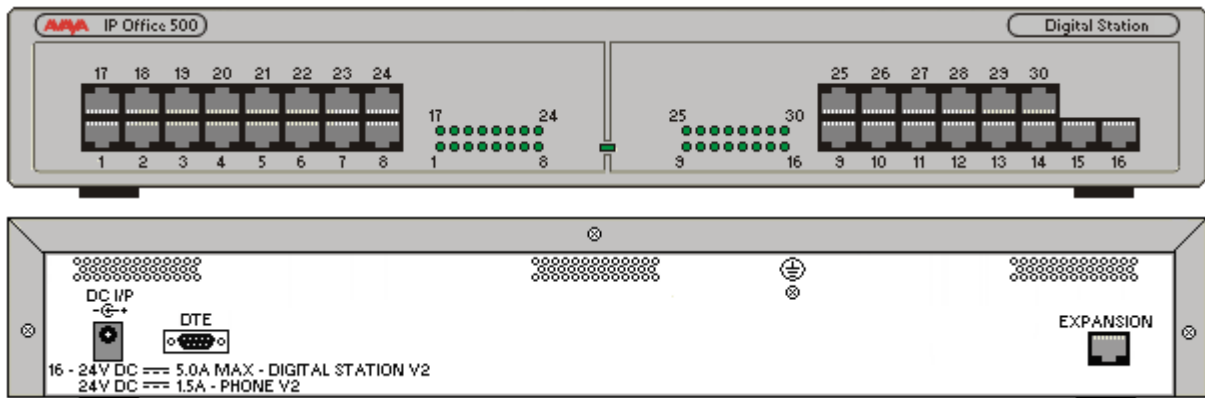

For systems where Direct Station Select (DSS) Units are being used, IP Office supports a maximum of:

- **BM32:** (1616)  
Up to 32 DBM32s supported (32 buttons each, up to 1024 buttons).
- **DSS4450:** (4412D+, 4424D+)  
Up to 8 DSS4450 modules per system (maximum of 2 per DS expansion module) (50 buttons each, max 400 buttons).
- **DBM32:** (1416)  
Up to 32 DBM32s supported (32 buttons each, up to 1024 buttons).
- **BM12:** (9508 digital; 9608 and 9641 IP telephones)  
Up to 36 buttons supported per telephone (3xBM12), up to 1024 buttons per system
- **EU24/EU24BL:** (4620, 4621, 5420, 5620, 5621/4620, 4621, 5620, 5621)  
Up to 8 EU24s per system (24 buttons each, max 196 buttons).
- **SBM24:** (9630G, 9640, 9640G, 9650, 9650C)  
Up to 42 SBM24 per system (24 buttons each, up to 1008 buttons).
- **T3 Series:** (All T3 telephones)  
Up to 30 T3 DSS modules supported. (36 buttons each, up to 1080 buttons). T3 DSS buttons are not included in the overall system limit for additional button module buttons.

The IP500 Phone module is available in two versions, giving either 16 or 30 extensions. The DS16/DS30 modules are used for Avaya phones and the DS16A/DS30A modules are used for BCM/Norstar phones. Refer to the following sections for information on the telephones supported on each module:

- [DS16/DS30](#) <sup>(104)</sup>
- [DS16A/DS30A](#) <sup>(104)</sup>

See the [Telephones Section](#) <sup>(107)</sup> for specific limits on the number of each type of telephone supported on DS modules.

## **DS16/DS30**

The DS16/DS30 modules support Avaya digital telephones only.

- DS16 – provides additional 16 digital station ports
- DS30 – provides additional 30 digital station ports

Telephones can be located up to 3280 feet (1km) from the control unit. For extensions located "out-of-the-building" additional line protection will be needed. For more information on cabling and out of building guidelines, see the IP Office Installation Manual.

## **DS16A/DS30A**

The DS16A/DS30A modules support legacy BCM, Norstar and M-Series telephones. DS16A/DS30A modules do not support BCM/Norstar ATA-2 or Avaya IP Office telephones.

If you have legacy telephones and Avaya telephones, IP Office will support a combination of DS16/DS30 and DS16A/DS30A modules. Up to 12 digital station modules are supported.

- DS16A – provides additional 16 digital station ports (BCM, Norstar T-Series and M-Series telephones only)
- DS30A – provides additional 30 digital station ports (BCM, Norstar T-Series and M-Series telephones only)

Telephones can be located up to 400m/1300 feet without SAPs or 650m/2100 feet with SAP from the control unit. For extensions located "out-of-the-building" additional line protection will be needed. For more information on cabling and out of building guidelines, see the IP Office Installation Manual.



## IP500 Analog Trunk 16 Module

This expansion module provides an additional sixteen Loop Start or Ground Start two-wire analog trunks. (Ground start trunks are not available in all territories) The first two trunks on the module which are automatically switched to power fail sockets on the rear of the unit in the event of power being interrupted must be loop start for correct power fail operation.

For installations in a rack, this module requires the IP500 Rack Mounting Kit. The IP500 Analog Trunk 16 Module is functionally identical to the IP400 Analog Trunk 16 Module.

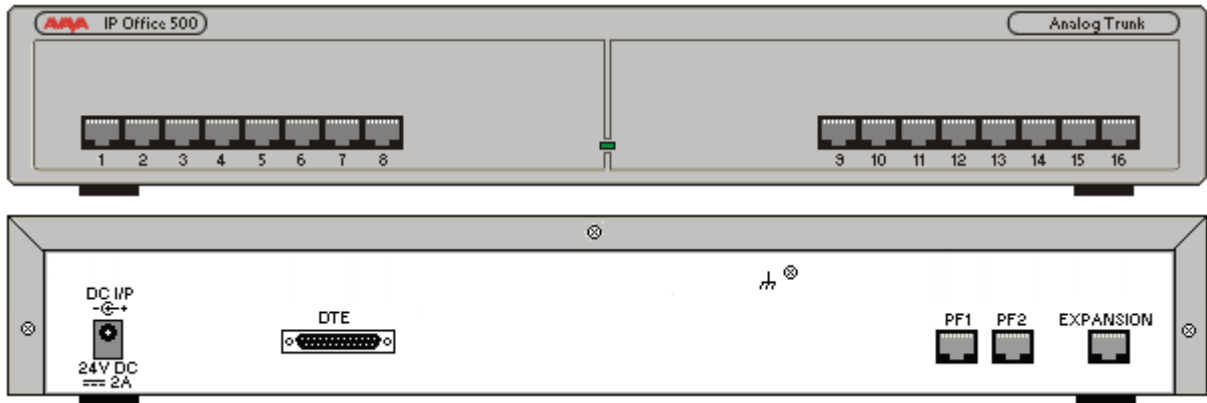

# Chapter 6.

# Telephones





## 6. Telephones

With a wide choice of desktop telephones, supporting both digital and IP interfaces, Avaya IP Office always has the right phone for a user. The portfolio is further enhanced with solutions for in-building wireless mobility, both using DECT and WiFi technology as well as the IP Office Video Softphone.

There is an easy way to select the right phone for your customer:

1. Decide on phone line: Cost efficient value line, key centric with paper labels? Or easy to maintain self labeling telephones, for customers where low TCO is important and installation and upgrading cost are a concern
2. Decide on Interface: Forward looking IP telephones for a Voice ready IP network? Or more traditional digital telephones, e.g. twisted pair cabling? Avaya gives the choice, while maintaining a consistent user interface and consistent functionality across both lines.
3. Decide in User profile: What role does the user have? Is he an everyday user, needing a standard phone workhorse? Or does he – e.g. as a manager – have to handle many calls? The User profiles give an easy way to get the right phone in each category for each person.

### SMEC Desktop Phone Portfolio

	Digital	IP
Paperless	<div style="border: 1px solid #0070C0; border-radius: 10px; padding: 10px; background-color: #D9E1F2;"> <p style="font-weight: bold; font-size: 1.2em; margin: 0;">9500</p>  <ul style="list-style-type: none"> <li>9504, 9508</li> <li>Backlight</li> <li>Paperless keys (12/24)</li> <li>Paperless expansion module (BM12)</li> <li>Full duplex handsfree (9508)</li> </ul> </div>	<div style="border: 1px solid #0070C0; border-radius: 10px; padding: 10px; background-color: #F4B084;"> <p style="font-weight: bold; font-size: 1.2em; margin: 0;">9600</p>  <ul style="list-style-type: none"> <li>Full duplex HF</li> <li>Gig-E available</li> <li>Color available</li> <li>Visual Voice</li> <li>Phone menu</li> <li>LCD Expansion</li> </ul> </div>
Value Line	<div style="border: 1px solid #0070C0; border-radius: 10px; padding: 10px; background-color: #A0C4E0;"> <p style="font-weight: bold; font-size: 1.2em; margin: 0;">1400</p>  <ul style="list-style-type: none"> <li>1403, 1408, 1416</li> <li>Backlight</li> <li>Paper labels</li> <li>Dual LEDs</li> <li>Especially for sub20 market, e.g. Partner Edition</li> </ul> </div>	<div style="border: 1px solid #0070C0; border-radius: 10px; padding: 10px; background-color: #808080;"> <p style="font-weight: bold; font-size: 1.2em; margin: 0;">1600</p>  <ul style="list-style-type: none"> <li>1603, 1608, 1616</li> <li>Backlight</li> <li>Dual LEDs</li> <li>Paper labels</li> <li>Especially for sub20 market</li> </ul> </div>

### Key-driven telephones for the cost-sensitive customer

The 1600 IP telephone and 1400 digital telephones are classical, cost effective Telephones designed especially around the needs of the Small and Mid-Size Business customer. Keys with clear red and green LEDs make access to lines and feature a breeze. These telephones are especially well suited for cost sensitive customers as well in scenarios where "key-system-functionality" is needed. They provide an easy migration path for users that have been accustomed to e.g. the 4400 line or the PARTNER line of digital telephones.

### Paperless telephones for fast installation and cost efficient changes:

The new 9600 IP telephones, as well as the 9500 Digital telephones are especially welcomed where a low cost of ownership is important. All telephones are equipped with paperless keys, making it easy to change features and button assignments from remote. Shift/page button allows access to a large number of lines or features that are shown dynamically in the display, making access to IP Office functionality easy while providing a clean, simple to use user-interface.

## Speakerphone options

Full-duplex speakerphone options are available for people that need a high quality personal speakerphone. All speakerphones are for personal use for one or two people sitting in front of the phone, not for a group-conferencing with people surrounding the phone.

## Access to telephones everywhere in and IP Office Network (SCN):

With support of hotdesking across a large line of telephones, IP Office telephones are perfect in an environment where people change their workplace regularly. With a simple login, users can make any telephone, digital or IP, their personal extension. This works not only in a single IP Office but also across a Multi-Site Network (Small Community Network), making traveling from one company site to another a breeze.

Even better, on 9600, 1600 and 1400 telephones, this functionality has been further enhanced by providing a centralized call log, directory and personal settings. When hotdesking to a different phone, call-logs and directory are instantly updated and synchronized over the network, eliminating e.g. lost calls as the call log was not available at a remote site.

## The right phone for every user:

Avaya IP Office Desktop telephones are designed to meet typical user needs in the small and mid business market:

Usage	Description	Applicable Phone Type(s)	Example User
<b>Walk Up</b>	Telephones in common areas like a meetings room, lobby or store. The telephones are normally used by casual users that walk-up to a phone where they make a quick phone call. Normally, no sophisticated features are needed.	1603, Digital:1403	Customer, Visitor, Meeting room phone
<b>Everyday</b>	Users that need a phone on their desk as part of their everyday job. While having a phone is important, the phone is just another tool on the desk for users using several alternative communication technologies.	IP 1603SW (Basic Everyday), 1608, 9608, Digital:1408, 9504, 9508	Engineer, Accountant
<b>Receptionist/Assistant</b>	A typical user manages a lot of calls, often as a significant part of their job. In many cases they also manage calls for others users and need to be efficient in connecting callers to the right people.	IP 1616 optional with BM32, 9608 optional with BM12; 9621, 9641 with optional BM12, Digital: 1416 with optional DBM32 9508 with optional BM12	Executive Assistant, Receptionist
<b>Executive</b>	For these users, handling a lot of calls is essential and they are constantly on the phone. Quite often, they handle multiple calls; they must always be connected, even when mobile. They require a set of rich, yet easy to use communication capabilities.	IP 9621, 9641, Digital: 9508 with optional BM12	Sales Executive, Banker, Lawyer, Project leader

---

## 9600 Series IP Telephones

---

Avaya one-X Deskphone is a family of next generation IP telephones that delivers a new and unique communications experience to drive increased productivity.

The Avaya one-X Deskphone family features an intuitive user interface which helps to make users proficient and confident in performing common telephone tasks such as setting up a conference call or completing a transfer. With high quality audio it is much easier to hear and understand other people, which speeds business while reducing fatigue and stress. The Avaya 9600 Series Deskphones are built with future growth and enhancement in mind, with many modular add-ons that can be added as they are needed – protecting investments and leading to improved total cost of ownership. The new telephones also feature a very stylish and professional design including support for customized display screen saver images and custom faceplates with company logos.

Common to all phones of the 9600 line on IP Office are two access modes to important IP Office features: Features can be assigned to the line/feature key of the telephone for easy and quick one-touch selection of the functionality giving users of other Avaya telephones a consistent user-interface.

In addition the features can be accessed through a menu, allowing quick access to seldom used features or even functionality that is not administered to a key. Similar to menus found on mobile and smartphones, this intuitive, “self-service” access frees the user from limits imposed by the number of keys on a telephone and allows access to the vast functionality of IP Office.

The status indication presents a clear view of important call settings like call forwarding numbers.

Visual Voice gives menu access to the voicemail messages received by a user for quick retrieval of the most critical information.

Personal and centralized directory access makes calling a breeze. A centralized call log allows one-touch call-back of missed calls, and is fully synchronized with other Avaya IP telephones or the one-X Portal application.

Full user mobility between different 9600 telephones, 1600 telephones and 1400 digital telephones support hotdesking and user mobility between different telephones with access to all the features found on the ‘home’ phone.

Customers are becoming more aware of the need to conserve energy due to costs and environmental considerations. The 9600 Series telephones have best in class power performance with the 9620L meeting PoE Class 1, and all other models being Class 2, including the Gigabit versions. Over the life of a product the reduced power demand of the 9600 Series results in significant cost savings for customers when compared to other competitive offerings that require more power, such as PoE Class 3 devices.

Please note that the 9600 telephones as well as the 9500 telephones are supported on IP Office IP500 and IP500 V2 hardware only.

## 96x1 Series IP Telephones

With IP Office 8.0 SP1 (Q1 2012) Avaya has released the 96x1 Release 6.2 firmware, which reintroduces the 96x1 phones to the IP Office platform. Besides significant quality improvements, the 96x1 Rls.6.2 firmware also provides support for the 9611G set on IP Office.

The 96x1 Release 6.2 firmware has also been released with the IP Office 7.0 SP Q1 2012.

The build VPN Client of 96x1 phones is currently not supported with the IP Office. This feature will be tested and released with a future IP Office release. Avaya recommends use of the 9600 Series phones if a VPN Client is required.

For information about supported Bluetooth headsets, please refer to the Avaya DevConnect website.

## 9608 and 9611G IP Telephones

These button-orientated models provide a more traditional user experience with dual color buttons on either side of the graphical display. These are ideal for customers who are migrating from a traditional digital environment and desire to move to IP with minimal change. As well as targeting more traditional users, the 9608 and 9611G are suited for Everyday users who use voice as an element within their business communications but are not considered power users.

The 9608 and 9611G models have eight (8) buttons around the display with four (4) on the left and four (4) on the right. Users can select to display information in a single column with four rows or in two columns with four rows each, depending on their needs. In two-column mode, approximately thirteen characters can be displayed on a line in each column. The exact number depends on the language and the characters because the font includes variable width characters.

Avaya continues to focus on low power and this model is Power over Ethernet Class 1 (802.3af). The 9608 and 9611G retain the industrial design of the other 9600 Series models. Please note that the power requirement and PoE class of the sets varies based on the configuration of connected interfaces such as button modules.

The 9608 and 9611G telephones are ready for future support of Wideband Audio on IP Office, giving a future proof investment path. Both models include full duplex hands-free support with a speaker and microphone.

Both sets include support for a new 2 x 12 button module on which features, speed dials, bridged or individual call appearances can be programmed. A maximum of three (3) button modules can be connected.

Each model also includes one touch access to key applications including Contacts, History and Home. One touch access to these core applications simplifies the user experience and eliminates the need to navigate through menus to get to the most commonly used features.

On top of that, when connected to IP Office these telephones will offer access to advanced IP Office features like Visual Voice, IP Office Feature menu or centralized storage for call log, system directory and personal directory. With that they offer full support of the hot-desking capabilities of IP Office.

The 9608 has a 3.8in/9.7cm monochrome display, while the 9611G features a 3.5in/8.9cm color screen. The dual position stand allows the sets to be positioned at approximately 40° or 60°. The display is fixed and is not adjustable like other 9600 Series IP Deskphones. The 9608 and 9611G do not support removable faceplates.



### Product Overview:

	9608	9611G
<b>Buttons</b>	8 with red/green LED	8 with red/green LED

<b>Administrable buttons (3 pages)</b>	24	24
<b>Color</b>	No	Yes
<b>Display (fixed)</b>	3.8 inch / 9.7 cm (181 x 120 pixel)	3.5 inch / 8.9 cm (320x 240 pixel)
<b>Softkeys</b>	4	4
<b>Dual Position Stand</b>	Yes	Yes
<b>Integrated Switch</b>	10/100	10/100/100
<b>USB Interface</b>	No	Yes
<b>Wideband Capability</b>	Handset, headset	Handset, headset
<b>Speaker</b>	Yes	Yes
<b>PoE Class (base level)</b>	1	1
<b>Applications Buttons</b>	Contacts, Home, History, Message, Phone	Contacts, Home, History, Message, Phone
<b>Other Keys</b>	Volume, Mute, Headset, Speaker	Volume, Mute, Headset, Speaker
<b>5 Way Navigation Cluster</b>	Yes	Yes
<b>Customizable Faceplate</b>	No	No
<b>Maximum Button Modules (2 x 12 buttons)</b>	3	3

## Features

### Display:

- **9608:** Monochrome display – 3.2 inches x 2.2 inches (8.2 cm x 5.5 cm)
- **9611G:** Color display – 2.8 inch x 2.1 inch (7.0 cm x 5.3 cm)

### Fixed Feature Buttons: 10 plus Four-way navigation cluster button.

- Volume up/down (separate volume levels for the handset, speaker, and ringer), Mute button (LED), Speaker button (LED), Headset button (LED).
- Avaya Menu button (browser, options and settings access), Telephony application button – to return to main telephone screen.
- Contacts button, history (Call log) button (LED), quick-access voicemail Message button with LED and corner message indicator.

### Programmable /Contextual buttons:

- 24 - in 3 switchable display pages of 8 matching the 8 physical display buttons. All 8 buttons with Dual LED indicator
- 4 contextual softkey buttons. Context sensitive allocation of e.g. Hold, Transfer, Conference and more.

### Key Labels: Icons and text used on fixed feature keys.

### Speakerphone: Full duplex speakerphone.

### Hearing Aid Compatible: Yes.

### Message Waiting Indicator: Yes - can also be used as a ringing call alert indicator.

### Personalized Ring Patterns: Three distinct ringtone styles. These include Classic, Alternate and Rich. The Classic and Alternate versions provide more legacy sounding ring tones. The Rich ringtones are more elaborate and nontraditional.

### Headset Socket: Yes. Bluetooth and DECT headset support (with adapter)

### Embedded Applications:

- Centralized call log and contact application, fully transparent between 9600 telephones, 1408/1416/1608/1616 telephones and Avaya one-X™ Portal for IP Office.
- Contacts application (up to 100 entries) and Call Log (Missed, Incoming, Outgoing, up to 30 calls). Please note that the Voice-dial feature of the 9600 telephones on Communication is not available on IP Office.
- Access to company directory and Visual Voice applications on IP Office.

**Upgradeable Firmware:** Yes.

**Expansion:** Support of up to 3 x BM12 button (2 x 12 buttons per module, total of max. 64 available buttons)

**Color:** Gray

**Mounting:** Desk or wall mountable.

**Adjustable Desk Stand:** Yes two-position stand, approx 40° and 60°angle

## IP Details

**Power Supply:** IEEE 802.3af Power over Ethernet (PoE) or individual PoE Injector power supply unit

**Power Class:** PoE Class (IEEE 802.3af) registers as class 1 device

**Codecs:** G.711, G.729a/b, G.722

### Supported Standards including Quality of Service:

- TCP/UDP/RTP/RTCP
- RSVP
- LLDP/LLDP-MED (including VLAN assignment)
- ARP/DNS
- 802.1Q (Layer 2 QoS)
- VLAN Separation
- DiffServ (Layer 3 QoS)
- Port Range (Layer 4 QoS)
- 802.1X (MD-5)

**SNMP Support:** Yes.

**IP Address Assignment:** Static or dynamic IP address assignment.

### Ethernet Ports:

- **9608:** Two port full-duplex 10/100 BaseT Ethernet switch for PC pass-through connection.
- **9611G:** Two port full-duplex 10/100/100 BaseT Ethernet switch for PC pass-through connection.



## 9621G and 9641G

The color touch-screen models, the 9621G and 9641G, evolve the user experience of the 9600 Series with a touch interface. Having color touch-screens on more models, with flexible software that can be enhanced in the future, these Deskphones provide a platform for near and long term enhancements that leverage the touch-screen capabilities. The 9621G and 9641G are targeted at Essential users who rely on the phone for business communications or those users that can benefit from tighter and easier access to a wider range of Avaya applications.

Both telephones are ready for future support of Wideband Audio on IP Office, giving a future proof investment path. The full duplex hands free audio performance is truly differentiating for heavy speaker phone users.

All the new 9600 Series IP Deskphones are low power including the 9621G and 9641G which are both PoE Class 2. The 9641G is the first IP Deskphone that can provide Gigabit Ethernet, a color screen AND a button module while consuming only PoE Class two power.

The 9621G and 9641G have a similar look and feel to the current 9600 Series models and include a dual position flip stand that positions the phone at approximately 20° in the low position or 60° in the upright position. The high resolution touch-screen displays are adjustable to 4 independent positions and both models support removable faceplates and have separate part numbers for versions without a faceplate.

The 9641G can be used with the BM-12 button module. A maximum of three button modules can be connected at one time. The 9621G does not support a button module.

The 9641G also includes a USB 2.0 interface.



### Product Overview:

	9621G	9641G
<b>Touch Screen</b>	Yes	Yes
<b>Administrable buttons (3 pages)</b>	24	24
<b>Color</b>	Yes	Yes
<b>Display (fixed)</b>	4.3 inch /10.9 cm	4.7 inch / 11.9 cm
<b>Dual Position Stand</b>	Yes	Yes
<b>Integrated Switch</b>	10/100/1000	10/100/1000
<b>USB Interface</b>	No	Yes
<b>Wideband Capability</b>	Handset, headset, speaker	Handset, headset, speaker
<b>PoE Class</b>	2	2
<b>Applications Buttons</b>	Contacts, Home, History, Message, Phone, Forward	Contacts, Home, History, Message, Phone, Forward
<b>Other Keys</b>	Volume, Mute, Headset, Speaker	Volume, Mute, Headset, Speaker
<b>Customizable Faceplate</b>	Yes	Yes
<b>Bluetooth Interface</b>	No	Yes
<b>Maximum Button Modules (2 x 12 buttons)</b>	0	3

### Common Features:

#### Display:

- 9621: Color touch-screen display – 3.7 inches x 2.1 inches (9.5 cm x 5.4 cm);

- 9641: Color touch screen display 4.1 inches x 2.3 inches (10.4cm x 5.9cm)
- 4-position adjustable tilt display

**Fixed Feature Buttons: 11**

- Volume up/down (separate volume levels for the handset, speaker, and ringer), Mute button (LED), Speaker button(LED), Headset button(LED).
- Avaya Menu button (browser, options and settings access), Home/Telephony application button – to return to main telephone screen.
- Contacts button, history (Call log) button (LED), quick-access voicemail Message button with LED and corner message indicator. Call Forward button

**Programmable /Contextual buttons:**

- 24 administrable keys/functions accessible through touch screen (different layout options)
- 0-5 contextual softkey buttons (touch screen). Context sensitive allocation of e.g. Hold, Transfer, Conference and more.

**Key Labels:** Icons and text used on fixed feature keys.

**Speakerphone:** Full duplex speakerphone.

**Hearing Aid Compatible:** Yes.

**Message Waiting Indicator:** Yes - can also be used as a ringing call alert indicator.

**Personalized Ring Patterns:** Three distinct ringtone styles. These include Classic, Alternate and Rich. The Classic and Alternate versions provide more legacy sounding ring tones. The Rich ringtones are more elaborate and nontraditional..

**Headset Socket:** Yes. Bluetooth and DECT headset support (with adapter); 9641: Built in Bluetooth adapter.

**Embedded Applications:**

- Centralized call log and contact application, fully transparent between 9600 telephones, 9500 telephones, 1408/1416/1608/1616 telephones and Avaya one-X™ Portal for IP Office.
- Contacts application (up to 100 entries) and Call Log (Missed, Incoming, Outgoing, up to 30 calls).
- Access to company directory and Visual Voice applications on IP Office.

**Upgradeable Firmware:** Yes.

**Expansion:** Yes. Support of up to 3 x BM12 button module (9641 only). (2 x 12 buttons per module)

**Color:** Gray.

**Mounting:** Desk or wall mountable.

**Adjustable Desk Stand:** Yes. Reversible wedge stand for desktop or wall-mount use and dual-position flip stand

**IP Details**

**Power Supply:** IEEE 802.3af Power over Ethernet (PoE) or individual power supply unit

**Power Class:** PoE Class (IEEE 802.3af) registers as class 2 device

**Codecs:** G.711, G.729a/b. ready for G.

**Supported Standards including Quality of Service:**

- TCP/UDP/RTP/RTCP
- RSVP
- LLDP/LLDP-MED (including VLAN assignment)
- ARP/DNS
- 802.1Q (Layer 2 QoS)
- VLAN Separation
- DiffServ (Layer 3 QoS)
- Port Range (Layer 4 QoS)
- 802.1X (MD-5)

**SNMP Support:** Yes.

**IP Address Assignment:** Static or dynamic IP address assignment.

**Ethernet Ports:** Two port full-duplex 10/100/1000 BaseT Ethernet switch for PC pass-through connection.

# 9600 Series IP Telephones

## 9620L, 9620C IP Telephones

Avaya 9620 IP Telephones are specifically designed for the everyday telephone user – those who typically rely on multiple communications tools such as e-mail and instant messaging (IM), yet still require a high quality and intuitive telephone for voice communications.

The Avaya one-X Deskphone family features an intuitive user interface which helps to make users proficient and confident in performing common telephone tasks such as setting up a conference call or completing a transfer.

With access to up to 12 lines and features through a simple-to-navigate interface, plus a clear view of 3 lines/features with LED indicators, the telephones are efficient to use while the small footprint consumes minimal space on a user's desktop.



Works on:	IP Office	Communication Manager
9620L	✓	✓
9620C	✓	✓

### Common Features

#### Display/Housing:

- 7-line 3.45 inch backlight graphical display with 320 x 160 pixels. 9620L: grayscale; 9620C: color
- Flip stand/dual position

#### Fixed Buttons: 10 plus Four-way navigation cluster button.

- Volume up/down (separate volume levels for the handset, speaker, and ringer), Mute button (LED), Speaker button (LED), Headset button (LED).
- Avaya Menu button (browser, options and settings access), Telephony application button – to return to main telephone screen.
- Contacts button, Call log button (LED), quick-access voicemail Message button with LED and corner message indicator.

#### Programmable/Contextual buttons:

- 4 contextual softkey buttons. Context sensitive allocation of e.g. Hold, Transfer, Conference and more.
- 12 virtual Appearance/Feature buttons, accessible through navigation cluster. Three features shown at a time with three LED indicators.

#### Key Labels: Icons and text used on fixed feature keys.

**Features Menu:** Mobile cell phone style menu with access to most often used features like Call Forwarding, Park, Settings etc. On screen status indication for activated features like call forwarding.

**Speakerphone:** Full duplex speakerphone

**Hearing Aid Compatible:** Yes - ergonomic hearing aid compatible handset also supporting TTY acoustic coupler.

**Message Waiting Indicator:** Yes - also useable as a ringing call alert indicator.

**Personalized Ring Patterns:** Yes - 8.

**Headset Socket:** Yes.

**Embedded Applications:**

- Centralized call log and contact application, fully transparent between 9600 telephones, 1408/1416/1608/1616 telephones and Avaya one-X™ Portal for IP Office.
- Contacts application (up to 100 entries) and Call Log (Missed, Incoming, Outgoing, up to 30 calls). Please note that the Voice-dial feature of the 9600 telephones on Communication Manager is not available on IP Office.
- Access to company directory and Visual Voice applications on IP Office.

**External Applications:** WML Application Interface

**Upgradeable Firmware:** Yes.

**Expansion:**

- **Adapter interface:** 9620L none, 9620C, one expansion module interface for e.g. Gigabit Ethernet adapter.
- **USB adapter:** 9620L none, 9620C: yes

**Color:** Black.

**Mounting:** Desk or wall mountable with optional wall mount adapter.

**Supports the following languages:** English, French, Spanish, German, Italian, Dutch, Portuguese and Russian (English and 4 of the other languages at once in the phone).

Note: While it may be possible to download other languages onto the phone, this will not be applicable to any data sent by IP Office. If you switch the language to any other not listed above, the display will show a mixture of the new language and the user's default language on IP Office.

**Requirements for IP Interface**

**Power Supply:** IEEE 802.3af Power over Ethernet (PoE) or optional wall plug local power supply. 9620L: PoE Class 1, 9620C PoE Class 2

**Codecs/audio:** G.711, G.729a/b, G.726, Dynamic Jitter buffer, Echo Cancellation, Comfort Noise, Automatic Gain Control.  
Ready for future support of G.722 wideband codec.

**QoS Options:** UDP Port Selection, DiffServ and 802.1p/q (VLAN).

**SNMP Support:** Yes.

**IP Address Assignment:** Static or dynamic IP address assignment.

**Ethernet Ports:** Ethernet (10/100) line interface with a secondary 10/100 port for co-located laptop or PC with VLAN separation.

**Support of optional Gigabit Ethernet Adapter:** 9620L: external. 9620C integrated adapter using adapter interface.

## 9630, 9640, 9640G Telephones

Smart, sleek, stylish and highly functional, the Avaya 9640 IP Telephone is designed for the Essential user, those for whom the telephone is essential in order to perform their jobs. Workers who conduct much of their business on the phone — moving from one call to the next. The Avaya 9630/9640 delivers advanced communications capabilities — high definition audio, a brilliant high resolution pixel based color display on the 9640, an integrated WML application interface, one-touch access to Avaya IP Office mobility or forwarding features — in a solution designed for those who are absolutely dependent on voice communications for their business operations.

With built in Gigabit Ethernet on the 9630G and 9640G, these telephones are also perfectly suited for customers with very high requirements for data network performance.



Works on:	IP Office	Communication Manager
9630G	✓	✓
9640	✓	✓
9640G	✓	✓

### Common Features

#### Display/Housing:

- 9-line 3.8 inch backlight graphical display with 320 x 240 pixels. 9650: grayscale; 9650C: color
- Flip stand/dual position

#### Fixed Buttons: 11 plus Four-way navigation cluster button.

- Volume up/down (separate volume levels for the handset, speaker, and ringer), Mute button (LED), Speaker button (LED), Headset button (LED).
- Avaya Menu button (browser, options and settings access), Telephony application button – to return to main telephone screen. Call Forward shortcut button
- Contacts button, Call log button (LED), quick-access voicemail Message button with LED and corner message indicator.

#### Programmable/Contextual buttons: 10.

- 4 contextual softkey buttons. Context sensitive allocation of e.g. Hold, Transfer, Conference and more.
- 6 self-labeled Appearance/Feature buttons with LED for access to 24 administered Appearances/Features at the side of the display.

#### Key Labels: Icons and text used on fixed feature keys.

**Features Menu:** Mobile cell phone style menu with access to most often used features like Call Forwarding, Park, Settings etc. On screen status indication for activated features like call forwarding.

**Speakerphone:** Full duplex speakerphone

**Hearing Aid Compatible:** Yes - ergonomic hearing aid compatible handset also supporting TTY acoustic coupler.

**Message Waiting Indicator:** Yes - also useable as a ringing call alert indicator.

**Personalized Ring Patterns:** Yes - 8.

**Headset Socket:** Yes.

**Embedded Applications:**

- Centralized call log and contact application, fully transparent between 9600 telephones, 1408/1416/1608/1616 telephones and Avaya one-X™ Portal for IP Office.
- Contacts application (up to 100 entries) and Call Log (Missed, Incoming, Outgoing, up to 30 calls). Please note that the Voice-dial feature of the 9600 telephones on Communication is not available on IP Office.
- Access to company directory and Visual Voice applications on IP Office.

**External Applications:** WML Application Interface

**Upgradeable Firmware:** Yes.

**Expansion:**

- 2 Adapter interface:
- USB 1.1 adapter
- SBM24 Module interface for up to 3 x SBM 32-button expansion modules (Note: If more than one button module is used, Power Class of phone needs to be switched to Power Class 3)

**Color:** Black.

**Mounting:** Desk or wall mountable with optional wall mount adapter.

**Supports the following languages:** English, French, Spanish, German, Italian, Dutch, Portuguese and Russian (English and 4 of the other languages at once in the phone).

Note: While it may be possible to download other languages onto the phone, this will not be applicable to any data sent by IP Office. If you switch the language to any not listed above, the display will show a mixed of the new language and the user's default language on IP Office.

**Requirements for IP interface**

**Power Supply:** IEEE 802.3af Power over Ethernet (PoE) or optional local power supply: Power Class 2 for all models including GiG-E versions.

**Codecs/audio:** G.711, G.729a/b, G.726, Dynamic Jitter buffer, Echo Cancellation, Comfort Noise, Automatic Gain Control. Ready for future support of G.722 wideband codec.

**QoS Options:** UDP Port Selection, DiffServ and 802.1p/q (VLAN).

**SNMP Support:** Yes.

**IP Address Assignment:** Static or dynamic IP address assignment.

**Ethernet Ports:**

- 9640: Ethernet (10/100) line interface with a secondary 10/100 port for co-located laptop or PC with VLAN separation.
- 9630G/9640G: Gigabit Ethernet (10/100/1000) line interface with a secondary 10/100/1000 port for co-located laptop or PC with VLAN separation.
- Support of optional integrated Gigabit Ethernet adapter using adapter interface.

## 9650, 9650C IP Telephones

Smart, sleek, stylish and highly functional, the Avaya 9650 IP Telephone is designed for the Essential and Navigator user profiles who need one touch access to features and bridged appearances of team/Partner buttons. Building receptionists, executive admin staff are examples of Navigator users who answer incoming calls, transfer customers to other extensions and monitor several bridged appearances throughout the day. This is the ideal solution for receptionists, executive assistants, Contact Center Agents as well as Knowledge workers that need quick access to partner and team features.



Works on:	IP Office	Communication Manager
9650	✓	✓
9650C	✓	✓

### Common Features

#### Display/Housing:

- 9-line 3.8 inch backlight graphical display with 320 x 240 pixels. 9650: grayscale; 9650C: color
- Flip stand/dual position

#### Fixed Buttons: 10 plus Four-way navigation cluster button.

- Volume up/down (separate volume levels for the handset, speaker, and ringer), Mute button (LED), Speaker button (LED), Headset button (LED).
- Avaya Menu button (browser, options and settings access), Telephony application button – to return to main telephone screen.
- Contacts button, Call log button (LED), quick-access voicemail Message button with LED and corner message indicator.

#### Programmable/Contextual buttons: 15.

- Four contextual softkey buttons. Context sensitive allocation of e.g. Hold, Transfer, Conference and more.
- 3 self-labeled Appearance/Feature buttons with LED for access to 24 administered Appearances/Features at the side of the display.
- 8 Additional self-labeled Appearance/Feature buttons with LED with direct access to 2 x 8 Appearances/Features.

#### Key Labels: Icons and text used on fixed feature keys.

**Features Menu:** Mobile cell phone style menu with access to most often used features like Call Forwarding, Park, Settings etc. On screen status indication for activated features like call forwarding.

**Speakerphone:** Full duplex speakerphone

**Hearing Aid Compatible:** Yes - ergonomic hearing aid compatible handset also supporting TTY acoustic coupler.

**Message Waiting Indicator:** Yes - also useable as a ringing call alert indicator.

**Personalized Ring Patterns:** Yes - 8.

**Headset Socket:** Yes.

**Embedded Applications:**



- Centralized call log and contact application, fully transparent between 9600 telephones, 1408/1416/1608/1616 telephones and Avaya one-X™ Portal for IP Office.
- Contacts application (up to 100 entries) and Call Log (Missed, Incoming, Outgoing, up to 30 calls). Please note that the Voice-dial feature of the 9600 telephones on Communication is not available on IP Office.
- Access to company directory and Visual Voice applications on IP Office.

**External Applications:** WML Application Interface

**Upgradeable Firmware:** Yes.

**Expansion:**

- 2 Adapter interface:
- USB 1.1 adapter
- SBM24 Module interface for up to 3 x SBM 32-button expansion modules (Note: If more than one button module is used, Power Class of phone needs to be switched to Power Class 3)

**Color:** Black.

**Mounting:** Desk or wall mountable with optional wall mount adapter.

**Supports the following languages:** English, French, Spanish, German, Italian, Dutch, Portuguese and Russian (English and 4 of the other languages at once in the phone).

Note: While it may be possible to download other languages onto the phone, this will not be applicable to any data sent by IP Office. If you switch the language to any not listed above, the display will show a mixture of the new language and the user's default language on IP Office.

**Requirements for IP interface**

**Power Supply:** IEEE 802.3af Power over Ethernet (PoE) or optional local power supply: Power Class 2

**Codecs/audio:** G.711, G.729a/b, G.726, Dynamic Jitter buffer, Echo Cancellation, Comfort Noise, Automatic Gain Control. Ready for future support of G.722 wideband codec.

**QoS Options:** UDP Port Selection, DiffServ and 802.1p/q (VLAN).

**SNMP Support:** Yes.

**IP Address Assignment:** Static or dynamic IP address assignment.

**Ethernet Ports:** Ethernet (10/100) line interface with a secondary 10/100 port for co-located laptop or PC with VLAN separation.

- Support of optional integrated Gigabit Ethernet adapter using adapter interface.

## SBM24 Adapter Module

The SBM24 Expansion Module is an optional device that extends the number of call appearances and Feature buttons available on the telephone. The SBM24 Expansion Module is supported on the 9630, 9640 & 9650 IP telephones and provides 24 additional programmable buttons - to be configured as call appearances, bridged appearances, or feature keys. A maximum of three SBM24 modules are supported on a single phone.



- 24 programmable call appearance/feature keys.
- Two backlight LCD screens for button labels. Buttons automatically labeled from the system (no paper labels).
- Connects directly to the associated phone.
- No separate power supply needed. However, using more than one button module changes the power class of the phone to Class 3.

The total number of SBM24 button modules supported on one IP Office system is 42, subject to the total system limits.

A Button Module adapter (Ferrite adapter), is required when SBM24 button expansion module is used with the 9630G or 9640G IP telephones.

---

## Accessories

### Bluetooth Adapter

The Bluetooth Adapter for 9600 Series IP Telephones allows Bluetooth communications devices such as headsets to interoperate with 9600 Series telephones. The adapter allows highly mobile workers to use the same Bluetooth headset with their 9600 Series Deskphone as they use with their cell phone.

The Avaya ABT-35H Bluetooth headset when used with the Bluetooth Adapter supports a wireless range of up to 30 feet from the Deskphone and provides simple call control (answer, hang-up) directly from the headset.

For users while at their desk, the Bluetooth Adapter allows the freedom of hands free communication along with investment protection for those already utilizing Bluetooth headsets while on the go. It supports the Avaya ABT-35 as well as many other third party Bluetooth Headsets

The Bluetooth Adapter can be used with all 9600 telephones except the 9620L. It requires a separate "Wedge stand."

### Gigabit Ethernet Adapter

The 9600 Gigabit Ethernet Adapter can be fully integrated into a wedge stand of the 9600 telephones and provides a transparent upgrade option if customers decide to install Gigabit Ethernet at a later date. It is fully integrated into the management interface of the 9600 telephones. It requires a separate "Wedge stand".

## Power Options for IP Telephones

Avaya supports the IEEE 802.3af, standard for Power over Ethernet (PoE) on its range of IP telephones. With Power over Ethernet, both power and data are carried over one CAT 5 Ethernet cable. Deploying IP telephones utilizing Power over Ethernet eliminates the need for local power supplies, AC adapters and cables, and allows power to be provided from the wiring closet/switch room where it can be easily connected to a UPS system.

There are two power options, in addition to IEEE Power over Ethernet, available to customers to power their Avaya IP telephones.

- Avaya individual Power Supply for 1600 Series telephones**  
 The 1600 Series telephones have a special power connector to allow the connection of a cost efficient power supply. These power supplies come in several versions for different countries and voltages.
- Avaya Power over Ethernet adapter for the 1603 phone**  
 The 1603 phone does not support Power over Ethernet natively. A small adapter is needed. The adapter will fit completely in the stand of the phone, offering a cost efficient option of either using a power supply or a PoE adapter.

### IP Telephone Power Consumption

Measured in Watts using an IEEE 802.3af power supply at 48V. This table shows the power consumption of the telephones currently shipping. Older versions of telephones might have a different power requirement.

Telephone	PoE Class	Power Consumption (Watts)		
		Conservation Mode	Typical	Max Power
<b>1603/1603SW</b>	2	4.32	3.75	5.10
<b>1608</b>	2	4.66	3.76	5.69
<b>1616</b>	2	3.17	2.83	3.65
<b>Gig Adapter</b>	–	3.16	N/A	5.81
<b>9620L</b>	1	2.1	2.2	2.7
<b>9620C</b>	2	4.6	4.9	5.3
<b>9630G</b>	2	4.6	4.9	6.1
<b>9640</b>	2	4.2	4.6	5.5
<b>9640G</b>	2	4.5	4.9	5.6
<b>9650</b>	2	4.6	5.2	5.6
<b>9650C</b>	2	4.6	5.2	5.6
<b>BM24</b>	n.a	0.39	0.6	0.9
<b>9608</b>	1	1.93	2.08	2.55
<b>9611</b>	1	2.64	3.12	3.78
<b>9621</b>	2	3.18	3.49	4.72
<b>9641</b>	2	3.28	3.44	4.12
<b>BM12</b>	n.a	0.10	0.31	0.62

### Avaya Individual Power Supply

The power supply can operate globally within a wide range of Alternating Current (AC) input voltages: 90 - 264 Volts Alternating Current (VAC), 47-63 Hz. This power supply has a green indicator (LED) that shows the unit has power to the PHONE socket on pins 7&8 of the CAT5 cable.

This item is available in two different versions, with and without an internal battery for uninterrupted power to the phone.



1151 local power supply, without battery and with battery backup

For 1600 Series telephones, a separate line of cost efficient power supplies is available in different regional versions.

---

## B100 Conference Telephones

---

The Avaya B100 Conference telephones provide the convenience and productivity benefits inherent in a powerful, hands-free conference phone. It offers a range of phones suitable for midsize and large conference rooms. B100 Series offer both SIP and Analog connections.

Avaya B100 offers superior HD sound quality for a lower cost without consuming bandwidth. Here are a few benefits to the customers:

- Increase business efficiency – telephone meetings are efficient, spontaneous, and simple. They help companies streamline their processes.
- Increase ROI – you create savings by reducing travel time and expense.
- Safeguard our environment – you protect our green environment when you substitute traveling with a highly efficient conference call.
- Be, and sound, professional – top-quality sound is essential for efficient, misunderstanding-free meetings.
- User friendly experience – B100 is packed with unique user friendly features that are not found on other competitors' products, such as connectivity with GSM cell phones, DECT, USB, Analog, and SIP, Conference Guide, PA connectivity, Wireless Headset Connection.
- Enjoy the leading SIP technology – B179 (a model in B100 Series) is a SIP based model which allows you to create more savings and efficiency in your telephony network.

This section of the document includes description, features and functionalities of each model, a feature comparison within the context of complete Avaya conference phone portfolio, accessories, compatible platforms, and countries the products are available in terms of Type Approval and Localization.

The Avaya B100 Series Conference Phones offer sophisticated and easy to use communication solutions for small to large companies. Providing superior voice quality with the award winning OmniSound® audio technology, the B100 Conference Phones cost effectively offer a variety of low bandwidth, plug-and play deployment options, that address the unique needs of different user groups within your organization with a broad choice of models.

With a sleek appearance and suite of smart productivity features, the B100 Series are an ideal choice for companies wanting to add end points to their existing infrastructure or with the deployment of a new network. The Conference phones can be used to complement scheduled meetings and training sessions or for impromptu calls between globally dispersed offices and remote workers.

**Crystal Clear Sound:** OmniSound® audio technology guarantees clear transmission during meetings – so you and your team don't miss a beat. Full Duplex transmits and receives sound simultaneously to prevent audio clipping, 360° surround sound and powerful speakers optimize sound pick-up and broadcasting. Noise suppression filters out static background noise and an Equalizer lets you adjust pitch to suit your preference.

**Plug and Play simplicity:** Connecting the Avaya B100 Conference Phones is fast and easy. There is a conference guide included, perfect for making multi-party calls and a handy phone book which is ideal for storing your key contacts.

**Flexibility and Productivity Enhancing Features:** The Avaya B100 Conference Phone portfolio compliments your existing solutions and can be easily re-deployed as your business grows or when needs change. Enhance web conferencing, video and other communications environments with the addition of these audio conferencing solutions.

---

## B149



Avaya B149 is an excellent choice when holding telephone conferences with-out compromising sound quality. The Avaya B149 is equipped with Avaya's patented OmniSound® 2.0 audio technology, for crystal-clear sound. Save your contacts in the phone book and use the conference guide to easily set up multi-party calls or pre-programmed group calls. Avaya B149 also has a built-in recording function that enables you to record your calls on an SD memory card. With its modern design, Avaya B149 will be a welcome addition to any conference room. It's also ideal in larger settings with the addition of optional expansion microphones. Hold productive telephone conference meetings that not only save time but the environment as well by cutting travel expenses. The Avaya B149 has the following advantages:

- OmniSound® 2.0
- Analog connection
- SD call recording
- Expandable with microphones
- Phonebook
- Conference guide

## B159

---



Avaya B159 is packed with many smart features and designed for flexible performance. Record your conversations on SD memory cards, while the line mode allows you to switch between and combine three connectivity technologies — analog, cell phones and USB. The conference guide helps you make multiparty calls and save call groups, which is very useful if you make regular calls to the same group. The Avaya B159 is also ideal in larger contexts as you have the option of adding expansion microphones, a wireless headset and a PA system too. It goes without saying that the Avaya B159 delivers ultimate sound quality, based on a brand new generation of OmniSound® 2.0, Avaya's crystal clear audio technology. Last, but not least — the Avaya B159 has an intriguing Scandinavian design that enhances any conference table. The Avaya B159 has the following advantages:

- OmniSound® 2.0
- Analog connection
- Connects to DECT/mobile phones
- USB-connection
- Connection for Wireless headset
- Expandable with microphones
- SD call recording
- Expandable for PA System
- Line selector
- Phonebook
- Conference guide
- Built-in bridging function

## B179



The Avaya B179 is a flexible SIP-based conference phone, perfect for companies that use IP voice services. Its clear, natural sound comes from OmniSound® 2.0, Avaya's patented wideband audio technology. The stylishly designed Avaya B179 is packed with intelligent features for more efficient conference calls. Use the conference guide to call pre-programmed groups with just a few simple pushes of a button. Conveniently import and export contact details via the Web interface. Create your own phone book with the personal user profile feature. The Avaya B179 is ideal for large conference room up to 30 square meter or 320 square foot. It is also perfect for larger conferences since it can accommodate expansion microphones, an external wireless headset and a PA system. With the Avaya B179 your company will have a conference phone that combines all the benefits of IP voice service with innovative new features. The Avaya B179 has the following advantages:

- OmniSound® 2.0
- SIP based
- 5-way conference calls
- SD call recording
- Built-in bridging function
- Expandable with microphones
- Connection for Wireless headset
- Phonebook
- Conference guide
- Expandable for PA System
- Web-based configuration of import/export of contacts and settings
- PoE (Power over Ethernet)
- With IP Office 8.0, the B179 supports G.722 HD Voice

The B179 is supported on IP Office R 7.0 and later. An IP Office Avaya IP Endpoint License is required to connect a B179 Conference Phone to the IP Office. (It is not required to use an IP Office 3<sup>rd</sup> Party IP Endpoint license for the B179).



---

## B100 Accessories

This section provides a list of accessories and compatible models. For more details about material code and pricing, please see Pricing & Material Code session.

When you order a phone, it already comes with some accessories. In the box, it includes:

- B179: the phone, AC adaptor 14 V DC, power cable, Ethernet network cable, SD memory card 2GB
- B159: the phone, AC adaptor 14 V DC, dual power / Analog line cable, SD memory card 2GB,
- B149: the phone, AC adaptor 14 V DC, dual power / Analog line cable

B100 offers various accessories. The section below explains how various accessories works in different situations:

- Power cable (material code 700501551) vs. extension power cable (material code 700501542): The power cable can work with all 3 models, connecting the AC Adapter and the phone, length 7.5M. You can increase the length to 15M by adding extension power cable. However, the extension power cable will not connect the AC Adapter and phone by itself. It will always need the power cable.
- Dual power/Analog line cable (material code 700501541) vs. Dual power/Analog line extension cable (material code 700501543): These cables work with B149 and B159 only. The power cable and analog cable are attached together. You will need the dual power / analog line cable to connect between the AC adapter, the RJ11 port, and the phone. In the case you want to double the length of the cable, you should add the dual power/Analog line extension cable to Dual power/Analog line cable. Extension cable power and analog telephone, 7.5 meters EIA-5320 class IV and 6/2. Extension adapter included.
- Various mobile phone cables: These mobile phone cables can connect your mobile phone to the conference phone and turn the conference phone into a loud speaker to share the conversation with other people in the room.
- USB cable for PC connection (material code 700501544): This USB cable provides connectivity between the phone and your PC to make VoIP calls.

PA interface box (material code 700501537): For connection to external loudspeaker and microphone system (PA system). Plug: RCA in/out. Connection cables 2.5 metres.

## B100 Feature Comparison

By offering the B100 Series, together with the current Avaya conference phone offering, Avaya now offers a complete range of conference phones across various protocols (SIP, Analog, and H323) and across small and large enterprise markets. The Avaya B179 SIP Conference Phone fills a gap within the Avaya portfolio, offering a conference phone complimentary with Avaya Aura SIP architecture.

Below is a comparison across Avaya conference phone portfolio.

	<b>B149</b>	<b>B159</b>	<b>B179</b>
<b>Material Code</b>	700501533	700501530	700501532
<b>AREA OF USE</b>			
<b>Large situation</b>		Yes	Yes
<b>Medium-sized conference room</b>	Yes	Yes	Yes
<b>Number of people / Area</b>	Up to 10 / 30 sq meter or 320 sq ft	Up to 10 / 30 sq meter or 320 sq ft	Up to 10 / 30 sq meter or 320 sq ft
<b>Number of people with expansion microphones / Area</b>	Up to 16 / 70 sq meter or 750 sq ft	Up to 16 / 70 sq meter or 750 sq ft	Up to 16 / 70 sq meter or 750 sq ft
<b>Number of people with PA connection</b>		More than 16	More than 16
<b>CONNECTION LINE</b>			
<b>Protocol</b>	Analog	Analog	SIP
<b>To cell phone and cordless handset</b>		Yes	
<b>To computers for VoIP</b>		Yes	
<b>FEATURES</b>			
<b>Sound technology</b>	OmniSound® 2.0	OmniSound® 2.0	OmniSound® 2.0
<b>Power over Ethernet</b>			Yes
<b>USB port for computer connection</b>		Yes	
<b>Keypad</b>	Yes	Yes	Yes
<b>Display</b>	128x64 pixels	128x64 pixels	128x64 pixels
<b>MENU with phonebook, language selection, call duration, etc</b>	Yes	Yes	Yes
<b>Date/Time</b>	Yes	Yes	Yes
<b>SD call recording</b>	Yes	Yes	Yes
<b>Phone book (Number of user profile)</b>	Yes (1)	Yes (1)	Yes (4)
<b>Conference guide</b>	Yes	Yes	Yes
<b>Line selector with bridging function</b>	Yes	Yes	
<b>Connection for wireless headset</b>		Yes	Yes
<b>OPTIONAL ACCESSORIES</b>			
<b>Expansion Microphones</b>	Yes	Yes	Yes
<b>Cables for GSM/DECT connection</b>		Yes	
<b>Interface box for PA system connection</b>		Yes	Yes

## 9504 and 9508 Digital Telephones

Avaya is continuing driving design innovation by offering two new paperless digital sets in the same design line as the 9600 telephones:

These telephones are delivering all the core values of the 5400 digital sets while innovating in areas like backlight displays for easy readability and full duplex handsfree support also on digital sets (9508 only)

The two button-orientated models, the 9504 and 9508, provide a traditional user experience with dual color buttons on either side of the graphical displays. These are ideal for customers who are migrating from a traditional digital environment and desire to move to IP with minimal change. As well as targeting more traditional users, these models are suited for Everyday users who use voice as an element within their business communications but are not considered power users.

The 9504 and 9508 models have 4/8 buttons around the display with 2/4 on the left and 2/4 on the right. Users can select to display information in a single column with two/four rows or in two columns with two/four rows each, depending on their needs. In two-column mode, approximately thirteen characters can be displayed on a line in each column. The exact number depends on the language and the characters because the font includes variable width characters.

As digital telephones, the new sets offer superior power efficiency. They are full powered from IP Office when

The 9508 includes support for a new 2 x 12 button module on which features, speed dials, bridged or individual call appearances can be programmed. A maximum of 3 button modules of either type can be connected to these Deskphones. Please note that a separate power supply is needed when a BM12 is connected.

Each model also includes one touch access to key applications including Contacts, History (previously Call Log) and Home (previously menu). One touch access to these core applications simplifies the user experience and eliminated the need to navigate through menus to get to the most commonly used features.

On top of that, when connected to IP Office these telephones will offer access to advance IP Office features like Visual Voice, IP Office Feature menu or centralized storage for call log, system directory and personnel directory. With that they offer full support of the hot-desking capabilities of IP Office.

The 9504 has a four-line monochrome display with backlight, while the 9508 has the same backlight 8-line monochrome display as the 9608 IP version.

These models support a dual position stand at approximately 40° or 60° degrees. The display is fixed and is not adjustable like other 9600 Series IP Deskphones. The 9504 and 9508 do not support removable faceplates.



9504



9508

### Product Overview:

	9504	9508
<b>Physical Buttons</b>	4	8
<b>Administrable buttons (3 pages)</b>	12	24
<b>Number of display Lines</b>	4	8
<b>Display (fixed)</b>	4-line	3.8 inch / 9.7 cm
<b>Softkeys</b>	4	4
<b>Dual Position Stand</b>	Yes	Yes

<b>Speaker/handsfree</b>	Yes	Yes. DSP based full duplex handsfree
<b>Applications Buttons</b>	Contacts, Home, History, Message, Phone	Contacts, Home, History, Message, Phone
<b>Other Keys</b>	Volume, Mute, Headset, Speaker	Volume, Mute, Headset, Speaker
<b>5 Way Navigation Cluster</b>	Yes	Yes
<b>Customizable Faceplate</b>	No	No
<b>Maximum Button Modules (2 x 12)</b>	none	3

**Please note that the 9600 telephones as well as the 9500 telephones are supported on IP Office IP500 and IP500 V2 hardware only.**

	<b>IP Office (IP500/IP500 V2)</b>	<b>Communication Manager</b>
<b>9504</b>	✓	✗
<b>9508</b>	✓	✗

Note: a second version of these digital telephones is planned for launch with Communication manager at a later time.

#### Common Features:

- **Display:** 9508: Monochrome Backlit display – 3.2 inches x 2.2 inches (8.2 cm x 5.5 cm); 9504: Monochrome Backlit display – 4 rows by 24 characters

**Fixed Feature Buttons:** 10 plus Four-way navigation cluster button.

- Volume up/down (separate volume levels for the handset, speaker, and ringer), Mute button (LED), Speaker button (LED), Headset button (LED).
- Avaya Menu button (browser, options and settings access), Telephony application button – to return to main telephone screen.
- Contacts button, history (Call log) button (LED), quick-access voicemail Message button with LED and corner message indicator.
- **Programmable /Contextual buttons:**
  - **9508:** 24 - in 3 switchable display pages of 8 matching the 8 physical display buttons. All 8 buttons with Dual LED indicator
  - **9504:** 12 - in 3 switchable display pages of 4 matching the 4 physical display buttons. All 4 buttons with Dual LED indicator
  - 4 contextual softkey buttons. Context sensitive allocation of e.g. Hold, Transfer, Conference and more.
- **Key Labels:** Icons and text used on fixed feature keys.
- **Speakerphone:** Full duplex speakerphone (9508), Two-way speakerphone (9504)
- **Hearing Aid Compatible:** Yes.
- **Message Waiting Indicator:** Yes - can also be used as a ringing call alert indicator.
- **Personalized Ring Patterns:** Yes – 8 (Traditional Avaya)
- **Headset Socket:** Yes. Bluetooth and DECT headset support (with adapter)
- **Embedded Applications:**
  - Centralized call log and contact application, fully transparent between 9600 telephones, 1408/1416/1608/1616 telephones and Avaya one-X™ Portal for IP Office.
  - Contacts application (up to 100 entries) and Call Log (Missed, Incoming, Outgoing, up to 30 calls). Please note that the Voice-dial feature of the 9600 telephones on Communication is not available on IP Office.
  - Access to company directory and Visual Voice applications on IP Office.
- **Upgradeable Firmware:** Yes.

- **Expansion:** Yes. Support of up to 3 x BM12 button (2 x 12 buttons per module, total of max. 64 available buttons) (9508 only). A separate power supply is needed when connection the BM12 to the phone as the digital line cannot power phone plus button module
- **Color:** gray.
- **Mounting:** Desk or wall mountable.
- **Adjustable Desk Stand:** Yes two-position stand, approx 40° and 60°angle

**Button Module 12 for 9508, 9608, 9641**

A new button module is being added to the portfolio. The 2 x 12 Button Module provides dual color LEDs/ buttons aligned with 12 rows on the graphical display. It includes two pages with 12 buttons each and a left or right arrow to indicate which page is currently not visible. When both pages are programmed the user has a total of 24 buttons available.

The 12 button module also includes a new quick-labeling feature button that is located under the display. Three 12 button module can be simultaneously connected to any one of the new 9600 Series IP Deskphones except the 9621G as well as with the 9508 digital phone. This button module ships with the same dual position stand as the 9508/9608.



Works on:	Up to three modules to be connected
9608	✓
9611	✓
9621	✗
9641	✓
9504	✗
9508	✓

- **Programmable /Contextual buttons:**
  - 24 administrable keys/functions accessible
  - 12 physical keys with LCD labels and dual LED
  - Quick-labeling key plus left/right page-key
- **Color:** gray.

Note: when 9508 is used, a separate power supply is needed to power the module.

---

## 1600 Series IP Telephones and 1400 Series Digital Telephones

---

Avaya one-X is a portfolio of communications solutions that deliver a powerful and consistent communications experience for the end user – across a variety of devices and interfaces. Avaya one-X solutions provide Intelligent Access to Intelligent Communications driving enhanced productivity and competitive advantage.

Avaya one-X Deskphone Value Edition, also called the 1600 Series of IP telephones, is a family of cost effective IP Telephones designed especially around the needs of the Small and Mid-Size Business customer.

For users of a digital solution, the 1400 Series of Digital telephones offer the same functionality and consistent communication experience on a line of digital telephones, giving customers the choice to select the right solution regardless of the method of connection.

With IP Office Release 6, the line of 1600 telephones has been further enhanced with the 1600-I Series, providing an easier-to-read graphical display with white backlight, consistent with the displays of the 1400 family.

Designed with the reliability you expect from Avaya, one-X Deskphone Value Edition telephones provide critical features and capabilities not often found in competitively priced models.

The family of 1400/1600 telephones consist of three models, designed around different user needs:

- The 1403/1603 phone is designed for the Walk Up user and basic Everyday user. For a Walk Up scenario, the 1403/1603 is used common areas in offices, stockrooms, lobbies, or drop-in desks. Users can be building visitors, employees, or even customers who need a phone with a simple, familiar user interface. The 1603 telephones comes in two versions: The 1603, a basic phone without Ethernet switch for locations where no PC is connected to the phone, typically for the walkup user, as well as the 1603 SW, with a basic Ethernet switch to connect additional components to the phone, well suited for the basic Everyday user.
- The Avaya 1408/1608 IP Telephone is designed for the Everyday user. Everyday users typically rely on several forms of communication including voice and email – and while they require a quality telephone, they rarely handle large amount of calls at the same time. Cubicle workers and sales staff are examples of Everyday users for whom the 1408/1608 delivers a productivity-enhancing telephone.
- The Avaya 1416/1616 IP Telephone is designed for the Receptionist/Assistant user. Receptionists, secretaries, and managers are examples of this type of user – people who answer incoming calls, transfer customers to different departments or extensions, and monitor several line appearances throughout a typical day. For the Receptionist/Assistant user, the 1416/1616 provides the most one-touch line/feature/speed-dial buttons without the need to scroll through on-screen lists.

All 1400 Series and 1600 Series telephones share a consistent design line and feature a button-centric layout. With fast access to all needed features like hold, transfer and conference, easily readable back-lit displays and a stylish design, they are an important addition to the Avaya portfolio of telephones for the Small and Mid-Size market.

All telephones share a number of feature keys with clear, paper labels. On the 1408/1608 and 1416/1616, features are also available through a feature list on screen that makes selecting features and line appearances easy even when hotdesking to another phone.

The telephones are accompanied by a complete set of accessories like cost efficient power supplies, easy to use paper labels and spare parts. For powering options for the 1600 IP telephones refer to the section [Power Options for IP Telephones](#)<sup>[124]</sup>.

For easy and efficient generation of labels, free DESI printing software is available from <http://support.avaya.com> (on the 1600 Phone Series page). This can be used to print all labels correctly formatted on plain paper or available DESI labels. A PDF document with correct formatting can also be downloaded. Additionally, labels can be printed in the correct format directly from IP Office Manager.

For 1600 Series telephones requiring Gigabit Ethernet support, a Gigabit Ethernet adapter is available - providing 10/100/1000 Mbps support for both the 1600 Series phone and co-located laptop or PC.

Note that no Ethernet cable is included with the 1600 Series telephones. If a cable is needed, it should be ordered separately at the required length.

## 1603 and 1603SW IP Telephones and 1403 Digital Telephones

This telephone is best suited for the Walkup and Basic Everyday user.



Works on:	IP Office	Communication Manager
<b>1603</b>	✓	✓
<b>1603 SW</b>	✓	✓
<b>1603-I</b>	✓ (R5 and later)	✓
<b>1603SW-I</b>	✓ (R5 and later)	✓
<b>1403</b>	✓	✗

On the 1600 line, only the 1603-I/603SW-I versions with improved display are available.

The Avaya 1403/1603 supports 3 line appearances. Each of the buttons includes dual LEDs (red, green) providing explicit status for the user. For a familiar look and feel, the 1403/1603 includes several fixed feature keys for common telephone tasks including conference, transfer, drop, hold, and mute. In addition, the 1403/1603 includes a 2-way speakerphone. The display on the 1403/1603 measures two lines by 16 characters and is backlit for easier viewing in all lighting conditions.

The 1603 SW telephone has the same features/functionality as the 1603 phone, it adds on top of that however a secondary Ethernet port and is therefore targeted at the basic Everyday user.

The newly introduced 1603-I/1603SW-I are functionally equal to the 1603/1603SW but feature a higher quality graphical display with white backlight, identical to the display of the digital 1403 telephone.

### Common Features:

#### • Display/Housing:

- Backlit display – 2 rows by 16 characters. Green backlight for 1603/1603-SW, white backlight for 1603-I, 1603SW-I, 1403.
- Reversible wedge stand for desktop and wall-mount use.

#### • Fixed Buttons: 10.

- Volume up/down (separate volume levels for the handset, speaker, and ringer), Mute button, Speaker button.
- Avaya Menu button (options and settings access).
- Hold button, Conference button, Transfer button, Drop button, Redial button.

#### • Programmable/Contextual buttons: 3.

- 3 line appearance key buttons – with dual LEDs (red, green) and paper labels (Printing tool available).

- **Key Labels:** Icons and text used on fixed feature keys.
- **Speakerphone:** Two-way handsfree speaker and microphone.
- **Hearing Aid Compatible:** Yes - ergonomic hearing aid compatible handset also supporting TTY acoustic coupler.
- **Message Waiting Indicator:** Yes - also useable as a ringing call alert indicator.
- **Personalized Ring Patterns:** Yes - 8.
- **Headset Socket:** No.
- **Upgradeable Firmware:** Yes.
- **Expansion:** None.
- **Color:** Black.
- **Mounting:** Desk or wall mountable.

#### **Requirements for 1403:**

- Connect to: Digital Station (DS) port.
- Power Supply: From phone system.

#### **Requirements for IP interface: (1603, 1603SW, 1603-I, 1603SW-I)**

- **Power Supply:** Optional IEEE 802.3af Power over Ethernet (PoE) adapter (class 2) or optional wall plug local power supply.
- **Codecs/audio:** G.711, G.729a/b, Dynamic Jitter buffer, Echo Cancellation, Comfort Noise, Automatic Gain Control.
- **QoS Options:** UDP Port Selection, DiffServ and 802.1p/q (VLAN).
- **SNMP Support:** Yes.
- **IP Address Assignment:** Static or dynamic IP address assignment.
- **Ethernet Ports:** 1603 - Single Ethernet (10/100) line interface. Support of optional Gigabit Ethernet Adapter.
- **Ethernet Ports:** 1603 SW Ethernet (10/100) line interface with a secondary 10/100 port for co-located laptop or PC with VLAN separation. Support of optional Gigabit Ethernet Adapter.
  - Well suited for everyday use, where typically smaller sized data files transferred (web, email file attachments) or less demanding data-transfer application/usage (thus less sensitive to data transfer completion times).
  - For highly demanding data traffic processing with large amounts of small packets we recommend the 1616 phone for full speed data throughput.

#### **Language Support:**

- 1403/1603: Supports the following languages: English, French, Spanish, German, Italian, Dutch, Portuguese and Russian (English and four of the other languages at once in the phone).



## 1608 IP Telephones and 1408 Digital Telephones

This telephone is best suited for the Everyday user.



Works on:	IP Office	Communication Manager
<b>1608</b>	✓	✓
<b>1608-I</b>	✓ (R5 and above)	✓
<b>1408</b>	✓	✓ (in future)

On the 1600 line, only the 1608-I version with improved display is available today.

The Avaya 1408/1608 supports 8 line appearances / feature keys. Each of the buttons includes dual LEDs (red, green) providing explicit status for the user. For a familiar look and feel, the 1408/1608 includes several fixed feature keys for common telephone tasks including conference, transfer, drop, hold, and mute. In addition, the 1408/1608 includes a high quality two-way speakerphone, and supports a broad portfolio of Avaya wired and wireless headsets through its integrated headset jack.

The 1408/1608 features a context sensitive user interface along with three softkeys and a four-way navigation cluster – ideal for scrolling through the local contacts list or call logs. The display on the 1408/1608 measures three lines by 24 characters and is backlit for easier viewing in all lighting conditions.

The newly introduced 1608-I is functionally equal to the 1608 but features a higher quality graphical display with white backlight, identical to the display of the digital 1416 telephone.

### Common Features:

- **Display/Housing:**

- Backlit display – 3 rows by 24 characters. Green backlight for 1608, white backlight for 1608-I, 1408.
- Dual position flip stand.

- **Fixed Buttons:** 15 plus Four-way navigation cluster button.

- Volume up/down (separate volume levels for the handset, speaker, and ringer), Mute button, Speaker button, Headset button.
- Avaya Menu button (options and settings access), Telephony application button – to return to main telephone screen.
- Hold button, Conference button, Transfer button, Drop button.
- Contacts button, Call log button, Redial button, quick-access voicemail Message button.

- **Programmable/Contextual buttons:** 11.

- 8 line appearance/feature key buttons – with dual LEDs (red, green) and paper labels (Printing tool available). Note: For typical installs, the first 3 buttons are reserved for standard call appearances; a minimum of 2 call appearance buttons is needed for standard operation.
- Three contextual softkey buttons.
- **Key Labels:** Icons and text used on fixed feature keys.
- **Features Menu:** Mobile cell phone style menu with access to most often used features like Call Forwarding, Park, Settings, etc. On screen status indication for activated features like call forwarding.
- **Speakerphone:** High quality two-way handsfree speaker and microphone.
- **Hearing Aid Compatible:** Yes - ergonomic hearing aid compatible handset also supporting TTY acoustic coupler.
- **Message Waiting Indicator:** Yes - also useable as a ringing call alert indicator.
- **Personalized Ring Patterns:** Yes - 8.
- **Headset Socket:** Yes.
- **Embedded Applications:**
  - Centralized call log and contact application, fully transparent between 1408/1608/1416/1616 phone, 9600 telephones and Avaya one-X™ Portal for IP Office.
  - Contacts application (up to 100 entries) and Call Log (Missed, Incoming, Outgoing, up to 30 calls).
  - Access to company directory and Visual Voice applications on IP Office.
- **Upgradeable Firmware:** Yes.
- **Expansion:** None.
- **Color:** Black.
- **Mounting:** Desk or wall mountable with optional wall mount adapter.

#### **Requirements for 1408:**

- Connect to: Digital Station (DS) port.
- Power Supply: From phone system.

#### **Requirements for IP interface (1608, 1608-I):**

- **Power Supply:** IEEE 802.3af Power over Ethernet (PoE) class 2 device or optional wall plug local power supply.
- **Codecs/audio:** G.711, G.729a/b, Dynamic Jitter buffer, Echo Cancellation, Comfort Noise, Automatic Gain Control.
- **QoS Options:** UDP Port Selection, DiffServ and 802.1p/q (VLAN).
- **SNMP Support:** Yes.
- **IP Address Assignment:** Static or dynamic IP address assignment.
- **Ethernet Ports:** Ethernet (10/100) line interface with a secondary 10/100 port for co-located laptop or PC with VLAN separation.
  - Well suited for everyday use, where typically smaller sized data files transferred (web, email file attachments) or less demanding data-transfer application/usage (thus less sensitive to data transfer completion times).
  - For highly demanding data traffic processing with large amounts of small packets we recommend the 1616 phone for full speed data throughput.
  - Support of optional Gigabit Ethernet Adapter.

#### **Language Support:**

- 1408/1608: Supports the following languages: English, French, Spanish, German, Italian, Dutch, Portuguese and Russian (English and four of the other languages at once in the phone).

## 1616 IP Telephones and 1416 Digital Telephones

This telephone is best suited for the Receptionist/Assistant User.



Works on:	IP Office	Communication Manager
1616	✓	✓
1616-I	✓ (R6)	✓
1416	✓	✓ (in future)

On the 1600 line, only the 16016-I version with improved display is available today.

The Avaya 1416/1616 supports 16 line appearances/feature keys on the phone itself – and up to 3 x 32-button expansion modules, providing access to a total of 112 line/feature keys or speed dial buttons. This will satisfy the needs of even the most demanding secretary or receptionist. Each of the buttons features a dual LED (red, green) providing explicit status for the user. For a familiar look and feel, the 1416/1616 includes several fixed feature keys for common telephone tasks including conference, transfer, drop, hold, and mute. In addition, the 1416/1616 includes a high quality two-way speakerphone, and supports a broad portfolio of Avaya wired and wireless headsets through its integrated headset jack.

The 1416/1616 features a context sensitive user interface along with three softkeys and a four-way navigation cluster – ideal for scrolling through the local contacts list or call logs. The display on the 1416/1616 measures four lines by 24 characters and is adjustable for optimum viewing angle. Additional caller related information is displayed with active appearances for easier call handling. The display is backlit for easier viewing in all lighting conditions.

The newly introduced 1616-I is functionally equal to the 1616 but features a higher quality graphical display with white backlight, identical to the display of the digital 1416 telephone.

### Common Features:

- **Display/Housing:**

- Backlit display – 4 rows by 24 characters with adjustable display angle. Green backlight for 1616, white backlight for 1616-I, 1416.
- Dual position flip stand.

- **Fixed Buttons:** 15 plus Four-way navigation cluster button.

- Volume up/down (separate volume levels for the handset, speaker, and ringer), Mute button, Speaker button, Headset button.
- Avaya Menu button (options and settings access), Telephony application button – to return to main telephone screen.
- Hold button, Conference button, Transfer button, Drop button.
- Contacts button, Call log button, Redial button, Quick-access voicemail Message button.

- **Programmable/Contextual buttons:** 19.
  - 16 line appearance/feature key buttons – with dual LEDs (red, green) and paper labels (Printing tool available). Note: For typical installs, the first 3 buttons are reserved for standard call appearances; a minimum of 2 call appearance buttons is needed for standard operation.
  - Three contextual softkey buttons.
- **Key Labels:** Icons and text used on fixed feature keys.
- **Feature Menu:** Mobile cell phone style menu with access to most often used features like Call Forwarding, Park, Settings etc. On screen status indication for activated features like call forwarding.
- **Speakerphone:** High quality two-way handsfree speaker and microphone.
- **Hearing Aid Compatible:** Yes - ergonomic hearing aid compatible handset also supporting TTY acoustic coupler.
- **Message Waiting Indicator:** Yes - also useable as a ringing call alert indicator.
- **Personalized Ring Patterns:** Yes - 8.
- **Headset Socket:** Yes.
- **Embedded Applications:**
  - Centralized call log and contact application, fully transparent between 1408/1608/1416/1616 phone, 9600 telephones and Avaya one-X™ Portal for IP Office.
  - Contacts application (up to 100 entries) and Call Log (Missed, Incoming, Outgoing, up to 30 calls).
  - Access to company directory and Visual Voice applications on IP Office.
- **Upgradeable Firmware:** Yes.
- **Expansion:** Module interface.
  - 1616: For up to 3 x BM32 32-button expansion modules (Note: An external power supply is needed for all installs with more than 1 button module).
  - 1416: for up to 3 x DBM32 32-button expansion modules (Note: An external power supply is needed in any case): **Note:** While the 1416 supports three DBM32, availability of the DBM32 will be slightly delayed compared to availability of 1416.
- **Color:** Black.
- **Mounting:** Desk or wall mountable with optional wall mount adapter.

#### **Requirements for 1416:**

- Connect to: Digital Station (DS) port.
- Power Supply: From phone system.

#### **Requirements for IP interface (1616 and 1616-I):**

- **Power Supply:** IEEE 802.3af Power over Ethernet (PoE) class 2 device or optional wall plug local power supply.
- **Codecs/audio:** G.711, G.729a/b, Dynamic Jitter buffer, Echo Cancellation, Comfort Noise, Automatic Gain Control.
- **QoS Options:** UDP Port Selection, DiffServ and 802.1p/q (VLAN).
- **SNMP Support:** Yes.
- **IP Address Assignment:** Static or dynamic IP address assignment.
- **Ethernet Ports:** Ethernet (10/100) line interface with a secondary 10/100 port for co-located laptop or PC with VLAN separation. Support of optional Gigabit Ethernet Adapter.

#### **Language Support:**

- 1416/1616: Supports the following languages: English, French, Spanish, German, Italian, Dutch, Portuguese and Russian (English and four of the other languages at once in the phone).

---

## **BM32 Button Module for 1616 IP Telephones and DBM32 Button Module for 1416 Digital Telephones**



The DBM32/BM32 Button Module extends the number of feature buttons on your Avaya 1416 Digital/1616 IP Telephone. It provides 32 additional buttons all with dual LEDs (red, green) for easy visibility.

Up to 3 DBM32/BM32 button modules can be connected to a 1416/1616 phone. The total number of DBM32/BM32 button modules supported on one IP Office system is 32, subject to the total system limits.

Note that the DBM32 can only be used with the Digital 1416 while the BM32 is for use with the 1616 IP phone.

Typical uses are:

- to provide additional lines for calls bridged from one or more other extensions
- to provide abbreviated dialing buttons
- to provide buttons to access additional switch features like call forwarding

Please note that an external power supply is always needed for a DBM32 connected to a 1416 telephone and is needed when connecting more than one BM32 to a 1616 telephone.

---

## T3 Telephones

---

The T3 range of digital UPN and IP telephones provide European style with context sensitive displays and are available in select European countries only. While the digital version is currently available, the IP version is no longer sold new. We recommend to use the 9600 line IP telephones instead.

---

### T3 Compact

This telephone is best suited for the Walkup User. It is available in Europe only.



**Note that the T3 IP compact is no longer available for new sales**

#### Common Features:

- **Display:** 1 line with 24 characters alphanumeric plus one line of icons
- **Fixed Feature Buttons:** 3 keys with printed text labels and 2 for Audio Volume control
- **Programmable Feature Buttons:** 3 keys with indicators and printed text labels, 2 keys with printed text labels
- **Speakerphone:** Full duplex handsfree speaker and microphone.
- **Hearing Aid Compatible:** Through optional handset
- **Message Waiting and call log Indicator:** Yes
- **Personalized Ring Patterns:** Yes, 8 ring patterns
- **Embedded Applications:** Navigation Cursor Control, Call signaling via LED and/or ringer; Alphanumeric entry via dialing keypad.
- **Color:** Graphite gray or polar white.
- **Mounting:** Desk or optional wall mountable.
- **Adjustable Desk Stand:** No

#### Features for T3 UPN only:

- **Upgradeable Firmware:** No.
- **Optional Add-Ons:** Up to 3 DSS Modules. T3 Headset link for wired headsets.
- **Headset Socket:** No. Optional headset add-on available.
- **Connect to:** Digital Station (DS) port.
- **Power Supply:** From phone system.

#### Features for T3 IP only:

- **Upgradeable Firmware:** Yes
- **Headset Socket:** Yes
- **Optional Add-Ons:** No
- **Power Supply:** IEEE 802.3af Power over Ethernet (PoE) or individual power supply unit.
- **Codecs:** G.711, G.729a/b.
- **QoS Options:** UDP Port Selection, DiffServ and 802.1p/q (VLAN)
- **SNMP Support:** No.
- **IP Address Assignment:** Static or dynamic IP address assignment.
- **Ethernet Ports:** Two port full-duplex 10/100 BaseT Ethernet switch.
  - Auto-negotiation provided separately for each port.
  - 802.3 Flow Control.

---

## T3 Classic

This telephone is best suited for the Everyday User. It is available in Europe only.



**Note that the T3 IP Classic is no longer available for new sales**

### Common Features:

- **Display:** 4 lines x 26 characters
- **Fixed Feature Buttons:** 5 preprogrammed keys with printed text labels and 2 for Audio Volume control
- **Programmable Feature Buttons:** 6 preprogrammed keys with indicators and printed text labels, 4 programmable keys with printed text labels
- **Speakerphone:** Two-way handsfree speaker and microphone.
- **Hearing Aid Compatible:** Through optional handset
- **Message Waiting and call log Indicator:** Yes
- **Personalized Ring Patterns:** Yes, 8 ring patterns.
- **Headset Socket:** No. Optional headset add-on available.
- **Embedded Applications:** Navigation Cursor Control, Call signaling via LED and/or ringer; Alpha entry via dialing keypad.
- **Optional Add-Ons:** Up to 3 DSS Modules. T3 Headset link for wired headsets.
- **Color:** Graphite gray or polar white.
- **Mounting:** Desk
- **Adjustable Desk Stand:** Display adjustable

### Features for T3 UPN:

- **Upgradeable Firmware:** No.
- **Optional Add-Ons:** up to 3 DSS Modules
- **Connect to:** Digital Station (DS) port.
- **Power Supply:** From phone system.

### Features for T3 IP:

- **Upgradeable Firmware:** Yes.
- **Optional Add-Ons:** up to 3 DSS Modules with AEI/Headsetlink,
- **Power Supply:** IEEE 802.3af Power over Ethernet (PoE) or individual power supply unit.
- **Codecs:** G.711, G.729a/b.
- **QoS Options:** UDP Port Selection, DiffServ and 802.1p/q (VLAN)
- **SNMP Support:** no.
- **IP Address Assignment:** Static or dynamic IP address assignment.
- **Ethernet Ports:** Two port full-duplex 10/100 BaseT Ethernet switch.
  - Auto-negotiation provided separately for each port.
  - 802.3 Flow Control.

---

## T3 Comfort

This telephone is best suited for the Executive as well as the Receptionist/Assistant User. It is available in Europe only.



**Note that the T3 IP Comfort is no longer available for new sales**

### Common Features:

- **Display:** 17 lines x 40 characters, Integrated keyboard
- **Fixed Feature Buttons:** 5 preprogrammed keys with printed text labels and 2 for Audio Volume control
- **Programmable Feature Buttons:** 6 preprogrammed keys with indicators and printed text labels, 6 preprogrammed keys with printed text labels, 10 user programmable keys with associated display labels.
- **Speakerphone:** Two-way handsfree speaker and microphone.
- **Hearing Aid Compatible:** Through optional headset
- **Message Waiting and call log Indicator:** Yes
- **Personalized Ring Patterns:** Yes, 8 ring patterns.
- **Headset Socket:** No. Optional headset add-on available.
- **Embedded Applications:** Navigation Cursor Control, Call signaling via LED and/or ringer
- **Optional Add-Ons:** Up to 3 DSS Modules. T3 Headset link for wired headsets.
- **Color:** Graphite gray or polar white.
- **Mounting:** Desk
- **Adjustable Desk Stand:** Display adjustable

### Features for T3 UPN:

- **Upgradeable Firmware:** No.
- **Optional Add-Ons:** up to 3 DSS Modules
- **Connect to:** Digital Station (DS) port.
- **Power Supply:** From phone system.

### Features for T3 IP:

- **Upgradeable Firmware:** Yes.
- **Optional Add-Ons:** up to 3 DSS Modules with AEI/Headsetlink,
- **Power Supply:** IEEE 802.3af Power over Ethernet (PoE) or individual power supply unit.
- **Codecs:** G.711, G.729a/b.
- **QoS Options:** UDP Port Selection, DiffServ and 802.1p/q (VLAN)
- **SNMP Support:** No.
- **IP Address Assignment:** Static or dynamic IP address assignment.
- **Ethernet Ports:** Two port full-duplex 10/100 BaseT Ethernet switch.
  - Auto-negotiation provided separately for each port.
  - 802.3 Flow Control.



---

## T3 DSS Expansion Modules

The T3 DSS Module is a phone expansion module that is compatible with all T3 UPN and T3 IP Telephones except the T3 IP Compact. Each module provides an additional 36 programmable buttons with associated printed text labels and indicators, and can be programmed for lines, groups or speed dial numbers. 3 DSS Modules can be added to each T3 phone. Power is provided by T3 UPN telephones, but an external power adapter is needed for each DSS module when used on T3 IP telephones.



Please refer to [System Button Module Support](#) for the total system limitations of button modules on IP Office.

---

## Wireless Phone Solutions

---

Avaya IP Office Wireless Solutions include analog, digital and IP-based WiFi wireless telephones. These are solutions employees can use every day to work more effectively and be more responsive to customers - all while increasing revenues and keeping communication costs firmly under control. Also, Avaya IP Office Mobility Solutions integrate seamlessly with IP Office, enhancing each customer's investment. IP Office's in-building Mobility Solutions improve communication with staff that, because of the function they perform, are mobile within the workplace. Using wireless technology, such individuals may be instantly contactable, with many obvious benefits;

- The wireless telephone is carried in the pocket, so users are not tied to the desk in order to remain in contact.
- Users may be contacted instantly to ensure fast, accurate decision making and immediate response to problems through planned radio coverage with no blind spots

### Avaya Wireless Solutions

IP Office supports the following wireless solutions:

- DECT R4, is the mainstream IP based DECT solution, offered in the EMEA and NA regions and in selected APAC countries. With the new Compact base-station, it is also the first choice for small installs with smaller channel/capacity need.
- IP-DECT in the EMEA and NA regions and in selected APAC countries is also supported on IP Office. Note that the IP-DECT solution will be eventually completely replaced by DECT R4.
- Digital Wireless North American market.
- Avaya VoIP WiFi Solution offered worldwide in selected countries including North America, EU countries and selected others.

IP Office supports the following VPN remote phone solutions:

- VPN phone functionality on all supported 9600 telephones. VPN functionality is an integral part of the 9600 software that does not require a separate software load but does require either a Teleworker or a Power User license.

---

## Wireless - DECT R4

The Avaya DECT R4 solution delivers the productivity-boosting benefits of IP and wireless communications across multiple offices in a convenient, lightweight handset. It provides businesses with a highly functional wireless solution with the ability to scale to support large numbers of users. This system also supports users in different offices connected via a WAN. The Avaya DECT R4 solution radio fixed part or IP base station (IPBS) connects to the IP Office using an IP protocol based on H.323.

Avaya's DECT R4 solution features all advantages of a full-blown DECT solution for the enterprise market: Cost-effective, high wireless voice quality in a frequency band exclusively reserved for DECT that is secure, easy to deploy and enhance.

DECT R4 also includes integrated administration and simplified install. This exposes more IP Office features to the DECT solution and reduces the TCO for both business partner and customer. Highlights include:

- Simplified install - 4 steps on the master base station, nothing on the slave; rest by handset prompts or IP Office Manager
- Simplified GUI mode on the base station displays options that are applicable to IP Office only
- All further administration via IP Office Manager, e.g. Adds. Moves and changes..
- Integrated handset in-call and out of call feature menu giving access to many features without programming the handset: Login/out, forwarding (including number), park/hold, conference etc
- Idle line display of user name/number including status indicator Do Not Disturb, parked/held calls, twinned, group etc.
- Additional display of calling number during alerting, using two lines of display
- Two new, special purpose handsets:
  - One ruggedized handset for use in e.g., industrial environments offering superb protection from liquids, dust etc.: 3740:
  - A special "intrinsically safe" handset for usage in areas with high risk of explosions, like coal-mines, refineries, gas stations etc. where e.g. a minor internal spark in the handset could otherwise ignite an explosion.: 3749
- DECT R4 is now available in additional regions, especially in the CALA theatre. Type approval has been achieved for Mexico, Brazil and Argentina. Please note that due to regulation, separate power supplies are required and not all powering/charging options may be available. Please refer to the DECT R4 product description on [support.avaya.com](http://support.avaya.com).

The cost-efficient 4-channel base-station "compact" offers a more economical solution for small installs of e.g. 3 base-stations/10 handsets where 4-radio channels are sufficient.

## System Overview

The complete DECT R4 solution consists of the following:

- Two wireless handsets (3720 and 3725) plus a line of accessories.
- Two 8-channel radio base stations (with internal and external antennas) with IP interface for usage with IP Office.
- A 4-channel Compact base-station for small installs, up to 5 can be used per system.
- An appliance server for centralized functions like corporate directory and internal phonebook access, simple text messaging, integration of messaging and other external applications, centralized configuration and maintenance etc.

As the solution contains a handset with liquid protection and BlueTooth headset interface and an appliance server for attaching messaging applications it is especially well suited for verticals like healthcare and retail.

All handsets and radio base stations support the DECT frequency bands in EMEA, APAC, NAR and CALA with the same hardware and firmware. (Please check type approval for availability in the different regions)

The Avaya DECT R4 solution on IP Office supports up to 120 handsets and 32 base stations. Each base station can be powered over the LAN using the Power over Ethernet (PoE) standard. Each base station can be also powered by an external power supply. There are two versions of the base station (IPBS) available: , a standard base station with fixed antennas and an enhanced base station with a variety of external antennas (External antenna not available in the US). Both base-stations can be installed in an outdoor housing to provide an "external" base-station.

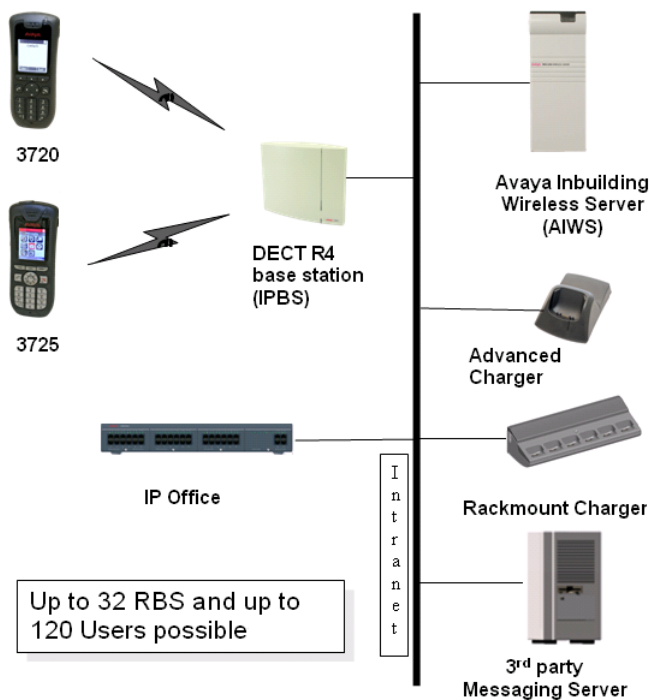

In all approved regions, this system supports the 3720 and 3725 handsets.

**Note:** A SARI certificate is required for the DECT R4 to work on IP Office.

### SARI Certification

Unlike IP DECT, DECT R4 does not require licensing. However, you still need to know the necessary number of VCM channels on IP Office. To uniquely identify a single system (e.g. to generate a PARK code) one SARI certificate (Secondary Access Rights Identifier) is required once per DECT installation to identify the system. The SARI is printed on paper and must be ordered separately.

Generally, each system requires its own SARI to e.g. avoid cross-usage of phones. While not recommended, a single customer with several sites, but non-overlapping base-stations, could use the same SARI certificate. A base-station can be added and changed without any problem.

## IP DECT Radio Base Station 1 (IPBS1)

The DECT R4 Radio Base Stations are used with IP Office only. You can have up to five base stations per system. Each station connects directly to a LAN switch using Ethernet cabling. The DECT R4 Radio Base Stations can either be powered by Power-over-Ethernet or by using external power supplies that are available as accessories.

Each standard DECT R4 Radio Base Station can handle up to eight concurrent calls while each Compact Radio Base Station can handle up to 4 concurrent calls. A special protocol called on-air synchronization ensures that active calls are seamlessly handed over from one DECT R4 Radio Base Station to the next one if a user with an active call roams through a building.

To make sure that the on-air protocol works and that the whole building is covered by the ranges of the DECT R4 Radio Base Stations, a site survey is needed to determine the number and placement of the DECT R4 Radio Base stations within the building. Avaya offers these site surveys as a service offer by AGS as well as measurement kits for business partners who want to do these site surveys on their own.

The on-air synchronization as well as the access to the phonebook of IP Office is done by a special software (master server) that can run in parallel to the standard DECT R4 Radio Base Station software on the same hardware.

In IP Office Release 8.0, IPBS2 replaces IPBS1. While they are functionally the same, IPBS2 can be used in a mixed configuration with IPBS1.



**DECT R4 Radio Base Station with internal antennas**

**DECT R4 Radio Base Station with external antennas**

Each base station has the following features:

- Two variants of the standard Radio Base Station: With Internal antenna and with External Antenna due to regulation, in the US only the base-station with internal antenna may be used.
- There are several antennas available for the base-station with external antenna: Standard, Directional Single, Directional Dual, Omnidirectional.
- One variant of the Compact Radio Base Station with internal antennas. The compact base station has the same look and feel as the base station with internal antenna.
- Outdoor housing available for both versions
- Up to five compact base stations per system can be installed
- 8 simultaneous voice and up to 12 signaling channels for the standard Radio Base Stations.
- 4 simultaneous voice and up to 12 signaling channels for the compact Radio Base Stations.
- Codec G.711, G723, G.729a/b for base station IP trunk connection.
- Power consumption
- Power over Ethernet or local power supply supported
- Power over Ethernet, IEEE 802.3af, class 2, typical 4W, maximum 5W consumption.

- Dimension: 200 (w) x 165 (d) x 56 (h) mm including mounting bracket
- Weight RBS: 450g.

### **IP DECT Radio Base Station 2 (IPBS2)**

Avaya is introducing the new IP base stations (IPBS2) for the DECT R4 to replace the first generation of IP base stations (IPBS1). There is no change to the functionality of the IP base station and the feature set provided on IP Office.

Avaya will continue to offer the same version of the IP base station 2 as currently offered for the IPBS1:

- IP base station 2 w/ internal antennas
- IP base station 2 w/ external antennas (for European Union, Switzerland, Iceland, Norway and Russia only)
- IP base station 2 Compact for IP Office

The IP base station 2 products are fully interoperable with the IP base station 1 products and the new IP DECT Gateway solution.

The IP base station 2 product also use the same housing as the equivalent IP base station 1 products which means that there is no change to the mounting products and IPBS1 units can be easily replaced with IPBS2 units if needed. External antennas and power supplies for IPBS1 can also be used with IPBS2.

## IP DECT Gateway Information

With IP Office R8, Avaya introduces a number of updates for the IP Office DECT R4 solution. The new IP DECT Gateway allows connecting digital base stations to the DECT R4 solution with the intention to leverage existing 4-wire cabling, for example when replacing an older PBX with IP Office.

In addition, Avaya is introducing new versions of the IP Base Stations (IPBS) and the Avaya Inbuilding Wireless Server (AIWS).

The new Avaya IP DECT Gateway solution consists of new digital DECT base stations connected to an Avaya IP DECT Gateway.

The solution extends the existing Avaya DECT R4 solution by making use of 4-wire UPN-cables. The Avaya IP DECT Gateway will enable digital DECT base stations to act as additional radios that belong to an Avaya DECT R4 system. The IP DECT Gateway will be connected to the LAN and communicate to the IP Office, AIWS, Chargers and any IPBS via IP.

Standalone Avaya IP DECT Gateway installations and mixed installations with DECT R4 IP base stations are possible.

DECT R4 IP Base Stations and Digital Base Stations use the same housing and accordingly the same mounting options can be used.

Major highlights of the Avaya IP DECT Gateway solution include:

- Up to 16 digital base stations can be connected to an Avaya IP DECT Gateway appliance
- Up to two IP DECT Gateways are supported per IP Office; stackable solution (multiple IP DECT GW appliances operating in one IP DECT system)
- Remote power feeding of digital base stations via UPN-ports
- Synchronization of attached digital base stations via UPN cables (including automatic cable delay measurement).
- Over-the air synchronization master for IP base stations. Master sync or backup sync functionality can reside in the gateway appliance.
- Seamless roaming and handover, also with IP base station on same site
- IP DECT master functionality can reside in an IP DECT Gateway
- Remote configuration and software upgrade of IP DECT Gateway appliance (web-based)
- Remote SW update of digital base stations connected to the Gateway appliance
- Support of same wireless handset types as in a pure IP DECT R4 installation only using IP Base Stations (3720, 3725, 3740, 3749, 3<sup>rd</sup> party CAP/GAP handsets providing same level of functionality as current DECT R4 IP DECT solution)
- Provision of same AIWS functions as with a pure IP DECT R4 installation only using IP Base Stations
- Configuration option for reuse of Avaya's UPN-repeaters: this means a configuration option for each base station port to disable the automatic cable delay measurement and instead manually set a cable delay for that specific port

The IP DECT Gateway introduces four new products:

- IP DECT Gateway
- Digital Base Station w/ internal antennas (for European Union, Switzerland, Iceland, Liechtenstein, Norway and Russia)
- Digital Base Station w/ external antennas (for European Union, Switzerland, Iceland, Norway and Russia)
- Digital Base Station w/ internal antennas (for US and Canada)

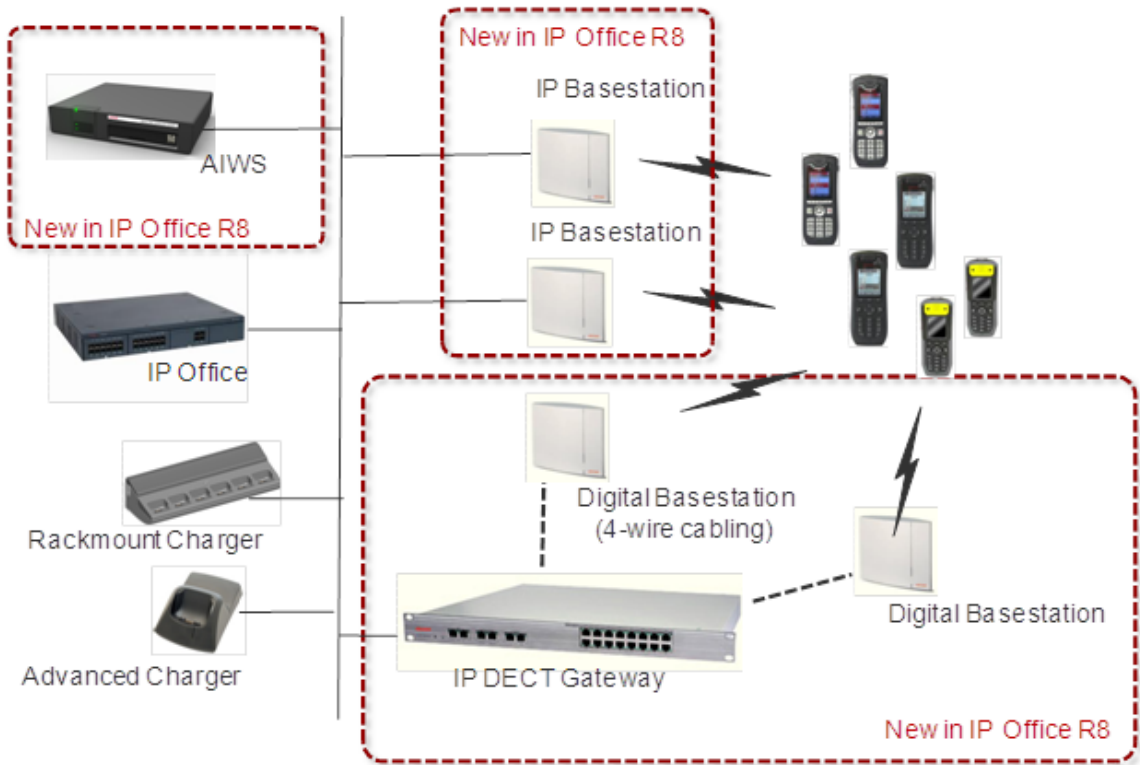

**Note:** Digital ISDN DECT Base Stations from Integral are NOT supported on the IP DECT Gateway.



## DECT Feature Overview

Given the degree of integration available to wireless users with DECT, there are a variety of means by which calls can be routed to wireless handsets:

- **Handover**  
While in motion, the handset performs continuous measurements to determine which DECT R4 base station has the strongest signal. The one that can be best received is defined as the active Base station. To prevent the handset from rapidly switching back and forth between two base stations that are equally well received, threshold values are used. Handover between base stations occurs seamlessly whether a call is active or not.
- **DECT Networking**  
An DECT R4 telephone can travel from one office to another which is connected over a wide area network (WAN) link and make and take calls. In this scenario the main DECT R4 controller remains at one "headquarters" location, with slave base stations in up to 31 other offices.
- **DDI/DID**  
Since each wireless handset is an extension on the IP Office system calls may be routed directly using a DDI/DID number.
- **Transfer**  
Calls may be transferred to DECT extensions by operators or other extension users and DECT extension users may transfer callers to any other extension user.
- **Hunt group compatibility**  
Wireless handsets may be programmed as members of groups and answer calls in the same manner as any other extension within that group.
- **Group working**  
Wireless handsets may be programmed as members of groups and attract calls in the same manner as any other extension within that group. DECT handsets must NOT be configured into collective groups.
- **Divert destination**  
Users may initiate any or all diverts from an Avaya desk phone to a wireless handset.
- **Twinning**  
Twinning allows calls to a user main extension number to alert at both that extension and a secondary extension. Though not restricted to DECT, this feature is aimed primarily at users who have both a desk phone and a wireless extension. Calls from the secondary twinned extension are presented as if from the user's main extension. Presentation of call waiting and busy is based on whether either of the twinned extensions is in use.
- **DECT R4 Capacities:**

Feature	DECT R4
Maximum Handsets	120
Maximum Base Stations if Master Server is on a standard RBS	32
Maximum Base Stations if Master Server is on a Compact RBS	5
Total Base Stations/Compact Base Stations	32
Total number of Compact Base Stations	5
Maximum simultaneous calls	100*

\*May be limited by the available VCM voice compression channels for calls to non-IP destinations. DECT R4 on IP Office does not support Redundancy option.

- **Redundancy**  
DECT R4 on IP Office does not support Redundancy option.
- **Licensing**  
Other than IP-DECT, DECT R4 does not require any licensing by itself (next to the licensing for the appropriate VCM channels in IP Office). However, a valid SARI license is required and must be ordered.

For each DECT handset one Avaya IP Endpoint license is required. In addition, one SARI Certificate is required for each DECT R4 system to uniquely identify that DECT R4 System. The SARI is printed on paper and must be ordered separately. This applies for regular IP Base Station as well as IP DECT Gateway type of deployments.

## DECT R4 Inbuilding Wireless Server 2 (AIWS2)

In IP Office Release 8.0, first generation AIWS has been replaced with AIWS2. The Avaya AIWS2 is a new application server module for DECT R4 solution to run applications such as messaging, central phonebook, LDAP directory access, centralized device management and OAP interface provision. AIWS2 handles wireless services and messaging, and runs on a solid state embedded server. It comes pre-installed, with the appropriate features activated on that server.

The Avaya AIWS2 servers supports the same feature set as the first generation AIWS servers.

Major highlights include

- 19-inch rack-mountable and wall-mountable, "pizza box" form factor
- Built-in power supply
- 400 MHz ARM9 processor with 256 MB RAM and 1GB On-board flash
- Basically support for all features support on AIWS1
- Upgrade capability from AIWS1 to AIWS2 (re-use of module keys, licenses, and configuration files from Elise 2 appliances possible)
- Full interoperability with AIWS appliances (mixed AIWS installations of AIWS1 and AIWS2 possible)

Avaya is introducing replacement part numbers for the AIWS2 products. In addition, a front mounting kit and a reverse mounting kit will be introduced.



For installation and maintenance, this server is managed by a PC using Windows Internet Explorer (7.0 or above) and Sun's Java Runtime Environment.

Several variants of the server are available. All Servers come fully installed and preloaded with licenses so no extra installation is needed. There is no upgrade available from e.g. Basic to standard.

	<b>Basic</b>	<b>Basic+</b>	<b>Standard</b>	<b>OAP</b>
<b>NTP Server</b> <i>(IP Office can also act as NTP Server)</i>	X	X	X	X
<b>Access To Central Phonebook</b>	X	X	X	X
<b>Access To Corporate Directories</b> <i>(LDAP on CM /TFTP on IP Office )</i> <i>(from Release 6, central IP Office phonebook is also supported directly on the Master RBS)</i>	X (only IP Office)	X (only IP Office)	X (IP Office & LDAP)	
<b>SMS Handset to Handset</b>	X	X	X	X
<b>Basic Web Messaging</b>	X	X	X	X
<b>Netpage Web Messaging</b>			X	
<b>Software Download Over-The-Air</b>		X (up to 32 handsets)	X (up to 120 handsets)	
<b>Software Download Via Advanced/Rack Charger</b>		X (up to 32 handsets)	X (up to 120 handsets)	
<b>Centralized Handset Configuration Over-The-Air</b>		X (up to 32 handsets)	X (up to 120 handsets)	
<b>Centralized Handset Configuration Via Advanced/Rack Charger</b>		X (up to 32 handsets)	X (up to 120 handsets)	
<b>Virtual SIM Card</b>		X (up to 32 handsets)	X (up to 120 handsets)	
<b>AIWS as Protocol Converter</b>				X (only OAP)

---

## 3720 DECT

This telephone is fully supported on the Avaya DECT R4 system.



### Standard DECT handset:

- Black and white display with Backlight and Icons
- Loudspeaker / hands free
- Graphical user interface
- Four way navigation key
- 6 built-in UI languages
- Standby 180 hours , Talk Time 16 hours (under optimal conditions).
- This handset is also GAP compatible. It can therefore be used on other DECT systems including Avaya IP DECT. However, when in GAP mode the functionality is limited to standard call, DECT roaming and handover. Access to other features including IP Office central directory and time of day is not available in GAP-mode.

## 3725 DECT

This telephone is fully supported on the Avaya DECT R4 system.



Standard DECT handset:

- Color Display with Backlight and Icons
- Loudspeaker / hands free
- Build in Bluetooth 2.0, supporting the "headset" profile. While others standard compliant headsets should work, Avaya has only tested a selected number. See list of [Headsets](#) <sup>(136)</sup>.
- Graphical user interface
- Four way navigation key
- 19 built-in UI languages. However, in some languages menu items may appear in the English language.
- Standby 180 hours, Talk Time 16 hours (under optimal conditions) Bluetooth headset interface (Bluetooth 2.0, handsfree profile)
- Liquid and dust protected (IP 44)
- Multi-functional button (alarm call, answer call, etc.)
- Text message support (requires AIWS, 30 messages sent/received storable, message length 160 characters)
- This handset is also GAP compatible. It can therefore be used on other DECT systems including Avaya IP DECT. However, when in GAP mode the functionality is limited to standard call, DECT roaming and handover. Access to other features including IP Office central directory and time of day is not available in GAP-mode.

The new DECT R4 handsets will work with the legacy IP DECT system. Nevertheless not all features available with the 3701 and 3711 handsets will be available on the DECT R4 handsets as well. An (incomplete) list of working features is:

- Subscription with PARK.
- Basic Call.
- Display Messages (with some limitations, e.g. truncation at end of line).
- Handover.
- Roaming.
- R-Key Handling (Enquiry call, Conference, ...).
- Feature Access Codes.
- Distinguish between internal/external calls.
- DTMF during call.
- Local call log (calling party numbers are transmitted).
- Local time and date.

Features already known to be not working with DECT R4 handsets and the legacy IP DECT system are

- Access of external directory (e.g. LDAP).
- Get time and date from the system.
- WML (WAP access).
- SMS/Messaging (not a feature of the legacy IP DECT system).

Generally it is highly recommended to do a sample installation with one handset first before rolling out a larger set of DECT R4 handsets on a legacy IP DECT system.

## 3740 Ruggedized DECT



This telephone is fully supported on the Avaya DECT R4 system.

- Black and white display with Backlight and Icons
- Loudspeaker / hands free
- Graphical user interface
- Four way navigation key
- 19 built-in UI languages. However, in some languages menu items may appear in the English language.
- Standby 150 hours, Talk Time 18 hours (under optimal conditions)
- Ruggedness: Shockproof certification IEC 60068-2-32, procedure 1 from 2 meters
- Operating temperature: -10°C to +55°C
- Liquid and dust protected (IP 65)
- Multi-functional button (alarm call, answer call, etc.)
- Text message support (requires AIWS, 30 messages sent/received storable, message length 160 characters).
- This handset is also GAP compatible. It can therefore be used on other DECT systems including Avaya IP DECT. However, when in GAP mode the functionality is limited to standard call, DECT roaming and handover. Access to other features including IP Office central directory and time of day is not available in GAP-mode.

## 3749 Intrinsically Safe DECT Handset



This telephone is fully supported on the Avaya DECT R4 system.

- Color display with Backlight and Icons.
- Loudspeaker / hands free.
- Build in Bluetooth 2.0, supporting the "headset" profile. While others standard compliant headsets should work, Avaya has only tested a selected number. See list of [Headsets](#) <sup>[16]</sup>.
- Graphical user interface.
- Four way navigation key.
- 19 built-in UI languages. However, in some languages menu items may appear in the English language.
- Standby 80 hours, Talk Time 10 hours (under optimal conditions).
- Ruggedness: Shockproof certification IEC 60068-2-32, procedure 1 from 2 meters.
- Operating temperature: -10°C to +55°C.
- Liquid and dust protected (IP 65).
- Multi-functional button (alarm call, answer call, etc.).
- Text message support (requires AIWS, 30 messages sent/received storable, message length 160 characters).
- Limitations due to power constraints for Intrinsically Safe handsets:
  - Display brightness is lower.
  - The keypad has no backlight for security reasons.
  - The vibrator and sound are not activated simultaneously (Ringing and vibration alternate).
  - The ring signal/beeper volume is slightly lower than 3740.
  - Loudspeaker volume is slightly lower than 3740.
- This handset is also GAP compatible. It can therefore be used on other DECT systems including Avaya IP DECT. However, when in GAP mode the functionality is limited to standard call, DECT roaming and handover. Access to other features including IP Office central directory and time of day is not available in GAP-mode.



## DECT R4 Handset Summary

	Telephone	3720 DECT Telephone	3725 DECT Telephone	3740 DECT Telephone	3749 DECT Telephone
<b>Keys:</b>	<b>Keypad</b>	yes	yes	yes	yes
	<b>Hook on/off buttons</b>	yes	yes	yes	yes
	<b>Softkeys</b>	3	3	3	3
	<b>Navigation cluster</b>	4-way	5-way	4-way	4-way
	<b>Volume buttons</b>		yes	yes	yes
	<b>Mute button</b>		yes	yes	yes
	<b>Alarm button</b>		yes	yes	yes
<b>Display:</b>	<b>Display, illuminated</b>	112 x 115 pixels, Black and white	128 x 160 pixels, 64K colors	128 x 160 pixels, Black and White	128 x 160 pixels, 64K colors
	<b>Battery indicator</b>	yes	yes	yes	yes
	<b>Signal strength indicator</b>	yes	yes	yes	yes
	<b>Time and date display</b>	yes	yes	yes	yes
<b>Audio:</b>	<b>Handsfree</b>	yes, 2-way speakerphone		yes, 2-way speakerphone	
	<b>Headset interface 2.5 mm</b>	yes		no, IP65 compatible special plug	
	<b>Bluetooth 2.0 Headset profile</b>	no	yes	no	yes
	<b>Supported Ring tones</b>	14	14	14	14
	<b>Ring tone volume</b>	8 levels		8 levels	
	<b>Vibration</b>	yes		yes	
	<b>Ringing options</b>	Ring, Vibration, visual		Ring, Vibration, visual	
	<b>Usage profiles</b>	Supported		Supported	
	<b>Key beep</b>	Yes, selectable		Yes, selectable	
	<b>Volume control</b>	8 levels	8 levels	8 levels	8 levels
<b>Features</b>	<b>Message LED (Red-green)</b>	yes	yes	yes	yes
	<b>Call log (Local)</b>	25 entries	25 entries	25 entries	25 entries
	<b>Local Directory/ Contacts</b>	250	250	250	250
	<b>Access to IP Office Directory</b>	Possible <sup>[1]</sup>	Possible <sup>[1]</sup>	Possible <sup>[1]</sup>	Possible <sup>[1]</sup>
	<b>Support of Text Messaging</b>	no	Optional <sup>[1]</sup>	Optional <sup>[1]</sup>	Optional <sup>[1]</sup>
	<b>Phone lock</b>	pin protected	pin protected	pin protected	pin protected
	<b>Keyes lock</b>	yes	yes	yes	yes
	<b>Programmable "in Call Feature" menu</b>	10 functions	10 functions	10 functions	10 functions
	<b>Programmable "Call Services" Menu</b>	10 functions	10 functions	10 functions	10 functions
	<b>GAP compliant</b>	yes	yes	yes	yes
<b>Hardware:</b>	<b>Battery</b>	Lithium Polymer	Lithium-Ion	Lithium-Ion	Lithium-Ion
	<b>Standby/Talk time - No Bluetooth</b>	160/16 hours	120/20 hours	150/18 hours	80/10 hours

	Telephone	3720 DECT Telephone	3725 DECT Telephone	3740 DECT Telephone	3749 DECT Telephone
	<b>Standby/Talk time - with Bluetooth</b>	n.a.	120/13 hours	n.a.	80/6 hours
	<b>Charge time</b>	4 hours	4 hours	4 hours	4 hours
	<b>Dust/Liquid Protection level</b>		IP 44	IP 65	IP 65
	<b>Ruggedness</b>	IEC 68-2-32, procedure 1, dropped 12 times from 1 metre		IEC 68-2-32, procedure 1, dropped 12 times from 2.0 m	
	<b>Intrinsically safe design (for use e.g. in mining, chemical industry, gas-stations)</b>	No	No	No	Yes
	<b>Size</b>	133 × 53 × 24	134 × 53 × 26 mm	143 × 59 × 29 mm	143 × 59 × 29 mm
	<b>Weight</b>	115 g (battery and clip included)	130 g (battery and clip included)	180 g (battery and clip included)	180 g (battery and clip included)
	<b>Belt clip options</b>	none, standard, swivel		none, standard, swivel	
<b>Localization :</b>	<b>Supported languages</b>	English,	Czech	Czech	Czech
		German	Danish	Danish	Danish
		Spanish	Dutch,	Dutch,	Dutch,
		French	English	English	English
		Downloadable language (one of 14 <sup>[2]</sup> )	Finnish	Finnish	Finnish
			French	French	French
			German,	German,	German,
			Greek	Greek	Greek
			Hungarian	Hungarian	Hungarian
			Italian	Italian	Italian
			Norwegian	Norwegian	Norwegian
			Polish	Polish	Polish
			Portuguese (Brazilian)	Portuguese (Brazilian)	Portuguese (Brazilian)
			Portuguese	Portuguese	Portuguese
		Russian	Russian	Russian	
Slovakian,	Slovakian,	Slovakian,			
Spanish	Spanish	Spanish			
Swedish	Swedish	Swedish			

1. Requires AIWS Server for integration with IP Office

2. Language supported on phone, IP Office menu items might appear in English.

## Supported Bluetooth Headsets on the 3725 and 3749 headsets

3725 and 3749 have built in Bluetooth 2.0, supporting the "headset" profile. While others standard compliant headsets should work, Avaya has only tested a selected number.

The following headsets are recommended:

- Plantronics Voyager 520
- Plantronics Voyager 835
- Plantronics Explorer 390
- Nokia BH-804
- Nokia BH-904
- SonyEricsson HBH-PV740
- Peltor M2RX7-WS4
- SonyEricsson HBH-PV702
- SonyEricsson HBH-GV435
- SonyEricsson HBH-IV835
- Plantronics Voyager510
- Plantronics Explorer665
- Nokia BH-201
- Jabra BT8010
- Motorola H350
- Motorola H670
- Samsung WEP4102

Features known to be networking with DECT R4 handsets and the legacy IP DECT system are

- Access of IP Office/ external directory (e.g. LDAP).
- Get time and date from the system.
- WML (WAP access).
- SMS/Messaging (not a feature of the legacy IP DECT system).

Generally it is highly recommended to do a sample installation with one handset first before rolling out a larger set of DECT R4 handsets on a legacy IP DECT system.

---

## DECT R4 Accessories and Site Survey Kits

### DECT R4 Accessories

In addition to the standard chargers, a number of high functionality chargers exist:

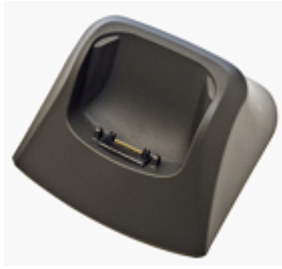

- **Basic Charger**
  - Charges one DECT phone (3720 and 3725)
  - Charge time: 4 hours.



- **Advanced Charger**
  - Charges one DECT phone (3720 and 3725)
  - Supports easy replacement of telephones
  - Connected to configuration tool PDM (Portable Device Manager) via USB or Ethernet
  - Charge time: 4 hours.



- **Rackmount Charger**
  - Same functionality as the advanced charger but for up to 6 DECT telephones (3720 and 3725)
  - Charge time: 4 hours.

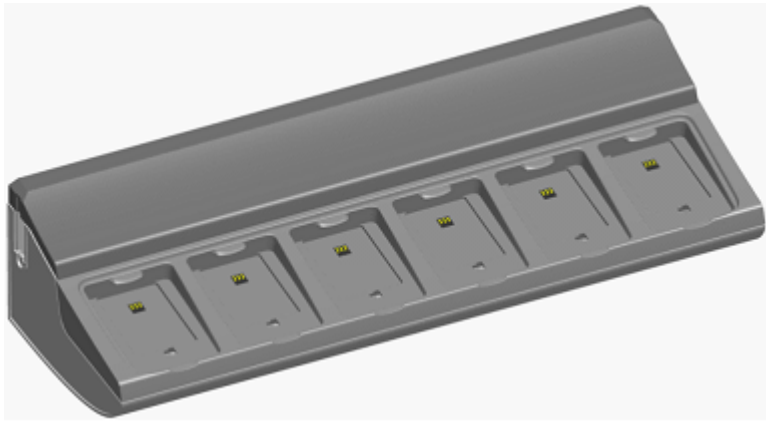

- **Multiple Battery Charger**
  - Charges 6 batteries (3725).
  
- **Portable Device Manager**

Software to be used in combination with Advanced or Rackmount Charger in order to Manage the 3720 and 3725 phone:

  - Requirements: Windows XP Professional, Service Pack 2 (SP2) or Windows Vista Business operating system, Sun Java Runtime Environment (JRE) 6 or later, Acrobat Reader 5 or higher.
  
- **Other accessories**
  - Handset Basic Belt Clip
  - Handset Swivel Belt Clip
  - Handset Leather Case (3720 and 3725)
  - Handset Security Chain

### Site Survey Kits

Site Survey Kits contain the items indicated in the table below. However, note that Site Survey Kits do not include IP Base Stations or handsets. As such, you must purchase the following items separately:

- Two IP Base Stations
- at least one of the following DECT handsets: 3725, 3740,3749 (3720 does not support the Site Survey mode)

Comcode	Description	Contents
70050121 6	DECT SITE SURVEY KIT V2 W/ BATTERY	<ul style="list-style-type: none"> <li>• One carrying case</li> <li>• Two brackets for placing the base stations on e.g. a door or on a tripod</li> <li>• Two battery cables to connect the battery to the base station</li> <li>• Two battery chargers incl. user manuals-</li> <li>• Interchangeable attachments / plugs (EU, UK, AU+US)-</li> <li>• Two battery packs</li> <li>• One user guide</li> </ul> <p>Usage only in EU/EFTA, US, Canada, Singapore and UAE</p>
70050121 7	DECT SITE SURVEY KIT V2 W/O BATTERY	<ul style="list-style-type: none"> <li>• One carrying case</li> <li>• Two brackets for placing the base stations on e.g. a door or on a tripod</li> <li>• Two battery cables to connect the battery to the base station</li> <li>• Two 0,5 m cable with DC plug</li> <li>• One user guide</li> </ul> <p>Usage in all countries where the DECT R4 portfolio can be sold</p>

## Wireless - Avaya IP DECT

**IP-DECT, while fully supported on IP Office R8, is no longer available for new sales or upgrades.**

The IP DECT solution delivers the productivity-boosting benefits of IP and wireless communications across multiple offices in a convenient, lightweight handset. It provides businesses with a highly functional wireless solution with the ability to scale to support large numbers of users. This system also supports users in different offices connected via a WAN. The Avaya IP DECT solution radio fixed part (RFP) or base station connects to the IP Office using an IP protocol based on H.323.

The Avaya IP DECT solution supports up to 120 handsets and 32 base stations. Each base station can be powered over the LAN using the Power over Ethernet (PoE) standard. Each indoor base station can also optionally be connected to main power via an external power adaptor. Each outdoor base station can only be powered using PoE - no individual power supplies are available to power the outdoor IP DECT base station.

In EMEA and APAC this system supports the 3701 and 3711 handsets.

In North America, only the 3711 handset is supported.

Note: The regulatory requirements for the radio part (base station and Handset) are slightly different in the US and Canada compared to EMEA and APAC. Therefore, while providing the same functionality, the hardware is different in these two regions.

Each Base station has the following features:

- 8 simultaneous Voice and up to 12 Signaling Channels.
- Codec G.711, G.723, G.729 for base station IP trunk connection.
- Handover  
While in motion, the handset performs continuous measurements to determine which IP DECT base station has the strongest signal. The one that can be best received is defined as the active Base station. To prevent the handset from rapidly switching back and forth between two base stations that are equally well received, threshold values are used. Handover between base stations occurs seamlessly whether a call is active or not.
- DECT Networking  
An IP DECT telephone can travel from one office to another which is connected over a wide area network (WAN) link and make and take calls. In this scenario the main IP DECT controller remains at one "headquarters" location.

Given the degree of integration available to wireless users with DECT, there are a variety of means by which calls can be routed to wireless handsets:

- **DDI/DID**  
Since each wireless handset is an extension on the IP Office system calls may be routed directly using a DDI/DID number.
- **Transfer**  
Calls may be transferred to DECT extensions by operators or other extension users and DECT extension users may transfer callers to any other extension user.
- **Hunt group compatibility**  
Wireless handsets may be programmed as members of groups and answer calls in the same manner as any other extension within that group.
- **Group working**  
Wireless handsets may be programmed as members of groups and attract calls in the same manner as any other extension within that group. DECT handsets must NOT be configured into collective groups.
- **Divert destination**  
Users may initiate any or all diverts from an Avaya desk phone to a wireless handset.
- **Twinning**  
Twinning allows calls to a user main extension number to alert at both that extension and a secondary extension. Though not restricted to DECT, this feature is aimed primarily at users who have both a desk phone and a wireless extension. Calls from the secondary twinned extension are presented as if from the user's main extension. Presentation of call waiting and busy is based on whether either of the twinned extensions is in use. In North America this functionality became available in Release 4.0.7.

### IP DECT Capacities

Feature	IP DECT
Maximum handsets	120
Maximum base-stations	32
Total base-stations/repeaters	32

<b>Maximum simultaneous calls</b>	100*
-----------------------------------	------

\*May be limited by the available VCM voice compression channels for calls to non-IP destinations.

## 3701 IP DECT

This telephone is fully supported on the Avaya IP DECT system. It is no longer available for new sales. However, it can also be used on the Avaya DECT R4 system in 'GAP-mode' with functionality limited to standard calling functionality, DECT roaming and handover. The built in feature list will not work on DECT R4.



- Listen-only handsfree speaker.
- SOS Emergency key for speed dialing an emergency number.
- Information key that can be used for:
  - Phone number lists and voice mail indication.
  - Information and speaker key flash when active.
- 50 phone book entries in every handset
- 10 possible ring tones with temporary mute.
- 4-level signal strength display.
- Speaker and handset volume, 3-levels and mute capability.
- Manual and automatic key lock (1 minute timer).
- Temporary ring tone muting.
- Silent charging.
- 12 menu languages: Czech, Danish, Dutch, English, Finnish, French, German, Italian, Norwegian, Portuguese, Spanish and Swedish. However, in the Czech and Norwegian language mode some menu items may appear in the English language.
- Illuminated 3-line graphic display (96 x 33 pixels), variable 3-level contrast.
- Stand-by time: Up to 100 hours.
- Talk time: Up to 10 hours.
- Charge time: max. 6 hours for empty batteries.
- Weight: 138 grams including 3 AAA (NiMH) batteries.
- Dimensions (Height x Width X Depth): 146 x 55 x 28 mm.

Optional telephone accessories include:

- Desktop charger.
- An adapter cord for use with headsets.
- Heavy-duty belt clip.



---

## 3711 IP DECT

This telephone is fully supported on the Avaya IP DECT system. It is no longer available for new sales. However, it can also be used on the Avaya DECT R4 system in 'GAP-mode' with functionality limited to standard calling functionality, DECT roaming and handover. The built in feature list will not work on DECT R4.



The 3711 phone supports the same features as the 3701 IP DECT handset but with the following differences:

- Full handsfree speakerphone operation.
- Headset connection (2.5 mm jack).
- Vibrating alarm.
- Personal phone book with 100 entries
- Access to system phone book.
- Voicemail indication.
- Choice from 30 ring tones.
- Speaker and handset volume, 7-levels and mute capability.
- Automatic call pick-up using a headset.
- 10 menu languages: Danish, Dutch, English, Finnish, French, German, Italian, Portuguese, Spanish and Swedish.
- Illuminated 5-line graphic display, (96 x 60 pixels), variable 7-level contrast.

Optional handset accessories include:

- Desktop charger.
- An adapter cord for use with headsets.
- Heavy-duty belt clip.

## Wireless - WiFi (802.11)

The Avaya IP Wireless solution offers an advanced Voice over IP (VoIP) client for wireless networks. This solution allows SME's to take advantage of the cost savings and simplified management of a converged voice and data infrastructure.

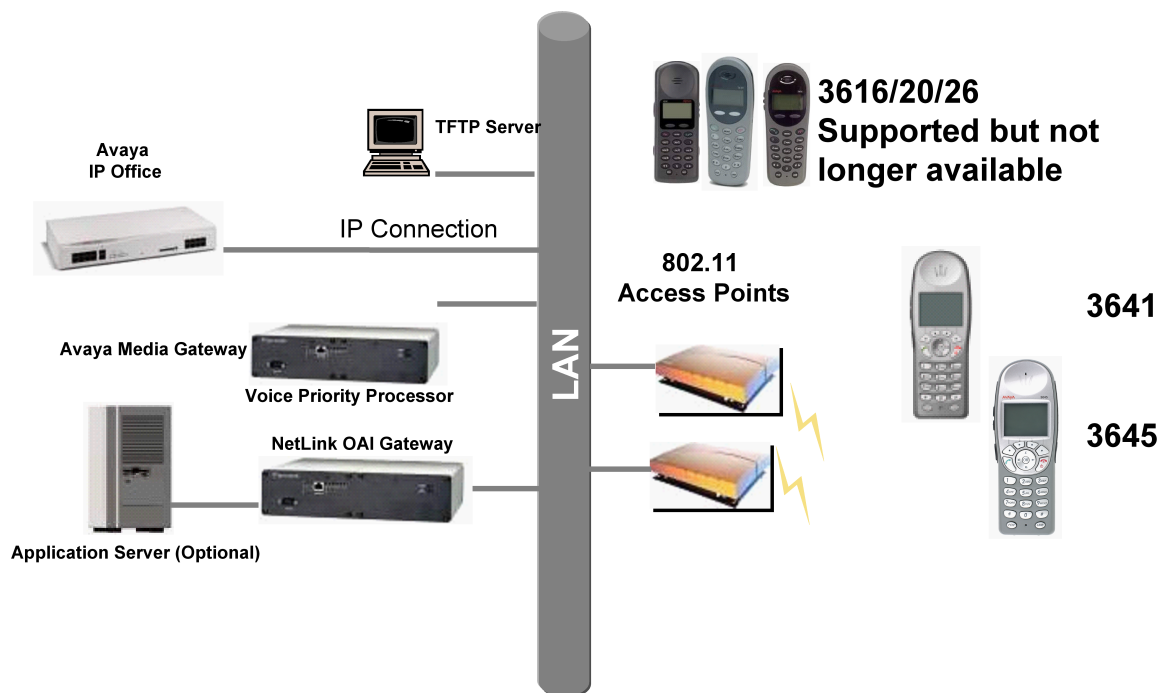

The 3641 and 3645 telephones provide an improved user-interface, a new lightweight design and a radio that supports several WiFi standards (802.11a/b/g). With these handsets customers have an increased choice to fit their needs and infrastructure.

Based on global standards for wireless LAN's, the Avaya IP Wireless Telephone Solution simplifies network infrastructure by enabling voice traffic to be carried along with data traffic over the same wireless network. 3616, 3620 and 3626 telephones are supported but no longer available from Avaya for direct sequence 802.11b WiFi networks; the 3641 and 3645 will also work in 802.11a and 802.11g networks. These telephones are also field upgradeable through external TFTP clients (not included), so telephones can be updated with new protocols, features, and capabilities as they become available.

Users can have a choice of an executive or rugged workplace telephone and all the productivity benefits of their desk telephone in this next generation of wireless telephone solutions.

### Wireless IP Terminals

Users can have a choice of 2 WiFi telephones to meet their in building mobility needs:

- Both support the 802.11 a/b/g standards and up to 12 lines or selected features. Both of these handsets are resistant to dust and spraying water and therefore also suitable for harsh environments. They also offer office-quality speaker-phone functionality.
- Avaya 3641 supports a broad range of enterprise applications and is ideally suited for general office, financial or hospitality industries. This compact handset offers a high-resolution backlight graphic display a new, improved user-interface and design and a lightweight form factor.
- Avaya 3645 is a slightly larger version that in addition supports "push-to-talk" functionality for broadcast communication between employees. Due to its rubberized sized grips and the larger ear cup it is especially well suited in noisy and industrial environments.
- Access to 2 x 6 lines or selected features through the "line" key and the "FCN" key (no individual labels are supported for the administered functions on the function keys, status information only for call appearances but not for line appearances).

### Standards based Quality of Service support

Since Summer 2010 IP Office R6 Maintenance Release a new software was made available for the 3641 and 3645 handsets. This software also allows use of open standard Quality of Service mechanisms based on WMM standards.

WiFi Multimedia (WMM) is a specification and certification program created by the WiFi Alliance, based upon the Enhanced Distributed Channel Access (EDCA) mechanism defined in the 802.11e standard. Avaya handsets support two QoS methods; the proprietary SpectraLink Voice Priority (SVP) developed to meet a gap which existed before 802.11e ratification and the standards-based WiFi Alliance Wireless Multi-Media (WMM). SVP or WMM-enabled APs and an AVPP are required for all Avaya wireless telephone installations, even if the WLAN is being used only for voice. Without a method of prioritization for voice packets, the lack of a controlled delivery method will result in poor audio quality, reduced capacity, poor handoffs and/or poor battery life even with only voice devices on the network.

The latest Avaya 364x H.323 GA software does support 802.11e (WMM), AVPP, or CCXv4 for voice prioritization/admission control and power management. It is important to note that the Access Point infrastructure can only be configured with one of the three options (e.g. you cannot have WMM and AVPP configured on the same AP). Also be aware that WMM or CCXv4 cannot be used if the customer has a mix of current 364x model and vintage 361x/362x model Handsets (e.g. in these deployment the only option is AVPP).

Even though the AVPP server is now an optional component for the 364x offering, the WLAN infrastructure deployed in a WMM or CCXv4 implementation must still be Voice Interoperability for Enterprise Wireless (VIEW) compliant per the following matrix: [http://supportdocs.polycom.com/PolycomService/support/global/documents/support/user/products/voice/VIEW\\_Certified\\_Products\\_Guide.pdf](http://supportdocs.polycom.com/PolycomService/support/global/documents/support/user/products/voice/VIEW_Certified_Products_Guide.pdf).

For example, the Avaya WLAN 8100 is now on the Polycom VIEW certified list with WMM (no AVPP server required) for use with the 364x (this configuration guide is posted on the Polycom VIEW portal at: [http://supportdocs.polycom.com/PolycomService/support/global/documents/support/user/products/voice/1725-36188-001\\_A.pdf](http://supportdocs.polycom.com/PolycomService/support/global/documents/support/user/products/voice/1725-36188-001_A.pdf)).

Basic WMM implementation in access points does not include Unscheduled-Automatic Power Save Delivery (U-APSD) and Call Admission Control (CAC), which are also defined in the 802.11e standard. Therefore, the AVPP is required to ensure the timing and delivery of Avaya voice packets, which is critical as the user hands off between APs and for improved battery life. The AVPP also provides call admission control and allows the number of calls per AP to be configured.

Please also refer to the Deployment Guide for Avaya-Polycom VoWiFi Telephones available on [support.avaya.com](http://support.avaya.com).

## Avaya Voice Priority Processors

The Avaya Voice Priority Processor (AVPP) is an Ethernet LAN appliance that works with access points to provide Quality of Service (QoS) on the wireless LAN if the network is not VIEW compliant. All packets to and from the wireless telephones pass through the AVPP and are encapsulated for prioritization as they are routed to and from IP Office. AVPP is fully compliant with the IEEE 802.11a/b/g standards.

AVPP is required for QoS because the current IEEE 802.11a/b/g wireless LAN standards provide only limited mechanism for differentiating audio packets from data packets. It also delivers quality of service by limiting the number of telephones that are connected to one access point in order to avoid quality problems. In addition AVPP ensures that the phone can run in energy-efficient mode when not in use. The following AVPPs are available to meet customer needs:

- AVPP100: Serves 80 calls simultaneously.
- AVPP020: Serves 20 powered-on handsets.
- AVPP010: Serves 10 powered-on handsets.

## Wireless Access Points

When using the Avaya Wireless IP solution, customers can utilize wireless access points from various vendors. The list of compatible wireless access points is large and constantly growing. Please visit [http://www.polycom.com/support/voice/wi-fi/view\\_certified.html](http://www.polycom.com/support/voice/wi-fi/view_certified.html) and select "WLAN Compatibility List" for the latest information.

## Benefits

- Supports 802.11 a/b/g standards for WiFi networks converging voice and data over a single network.
- Seamless integration with IP Office.
- Excellent voice quality on converged wireless networks.
- Lightweight, durable handsets specifically designed for workplace use.
- Improved display, battery life, processor power all with lower costs.
- Increased range of AVPP's to address the needs of diverse construct sizes.
- Multitude of accessories are available:

- Dual Charger (full charge accomplished in approximately one and a half hours).
- Quick Charger (full charge accomplished in approximately one and a half hours).
- Single, Dual, and Quad Chargers for the 3641 and 3645 telephones.
- Belt Clip.
- Nylon Pouch.
- Carrying case with Lanyard.
- Hands Free Pouch.
- Noise canceling headset.
- Over the ear headset.

### **Avaya IP Wireless Telephony Solution (AWTS) Open Application Interface (OAI) Gateway**

The AWTS Open Application Interface (OAI) Gateway enables third- party software applications to communicate with the Avaya IP Wireless Telephones. This serves as a two-way messaging device. Many companies provide applications that interface to your in-house paging systems, email, and client-server messaging. Other vendors with complementary systems such as nurse call, telemetry, alarm, and control system manufacturers are currently developing applications to interface with the Avaya IP Wireless Telephone solution.

---

## 3641 Ruggedized Wireless Telephone

The Avaya 3641 Wireless Telephone is a WiFi standard (802.11a/b/g) telephone that runs using H.323.



The 3641 supports the following features:

- Slim lightweight design with large display.
- Backlight display with Icons.
- Simple to use with improved user interface.
- Navigation and soft keys for simple access to frequently used operations.
- Office-quality speakerphone for handsfree operation.
- 802.11a/b/g standard-compatible.
- Radio Frequency 2.4000 GHz (b/g) or 5.8 GHz (a).
- FCC certification Part 15.247.
- Management of telephones via DHCP and TFTP.
- Voice encoding G711, G.729a.
- Wired Equivalent Privacy (WEP), 40bit and 128 bit and 802.11i (PSK) for secure communication.
- Lithium Ion Battery pack with up to 8 hours talk time and 160 hours standby.
- IP-53 Design (Liquid/dust protection).
- MIL 810F Design (Shock protection).
- Clips, cases, lanyard.

---

## 3645 Ruggedized Wireless Telephone

The Avaya 3645 Wireless Telephone is a WiFi standard (802.11a/b/g) telephone that runs using H.323.



The 3645 supports all of the features of [3641](#)<sup>[173]</sup> with the following additions:

- Push-to-talk (PTT) functionality for workgroup communication
- Enlarged earpiece for operation in noisy environments
- Rubberized grips for improved ergonomics and durability

---

## 3616 Wireless Telephone

**While no longer available, this WiFi telephone is still supported on IP Office Release 8.0.**

The Avaya 3616 IP Wireless Telephone is a WiFi (802.11b) telephone that runs using H.323.



The 3616 supports the following features:

- Lightweight innovative design .
- Simple to use.
- 802.11b standard-compatible.
- Radio Frequency 2.4000 – 2.835 GHz (SMI).
- Transmission type Direct Sequence Spread Spectrum (DSSS).
- FCC certification Part 15.247.
- Management of telephones via DHCP and TFTP.
- Voice encoding G711.
- Transmit Power 100mw peak, <10mW average.
- Wired Equivalent Privacy (WEP), 40bit and 128 bit.
- 2x16 character alphanumeric, plus status indicators.
- 4 hours talk time and 80 hours standby.

---

## 3626 Ruggedized Wireless Telephone

**While no longer available, this WiFi telephone is still supported on IP Office Release 8.0.**

The Avaya 3626 Wireless Telephone is a WiFi standard (802.11b) telephone that runs using H.323.



The [3626](#) <sup>(175)</sup> supports all of the features of 3616 with the following differences:

- Designed for industrial environments.
- Ruggedized durable design.
- Push-to-talk (walkie-talkie) feature for broadcast communications between employees.

**Note:** 3626 supports both R1.0 and R2.0 firmware on the set itself. However, as of R3.1 of IP Office, only 3626 phone R1.0 firmware is supported.



---

## Digital Wireless 3810 Telephone

The Digital Wireless 3810 Telephone is supported but is no longer for sale.



### Features

- 2-line, 32 character Handset Liquid Crystal Display (LCD).
- 10 hours of talk time, and 4 days of standby time.
- 4 displayed operation modes indicating Talk, Ringer On/Off, Battery Low, and Message Waiting.
- Single button access to fixed features – Hold, Transfer, Conference, and Redial.
- 4 programmable buttons to access features on the PBX.
- 20 Number Memory for quick and easy speed dialing
- 10 channels, supporting up to 10 simultaneous conversations in overlapping radio coverage areas.
- Headset jack.
- Ringer and Handset volume control.
- User selectable ring type.
- Vibrate alert.
- Redial Button
- Base Unit and Charger Unit.

The Avaya 3810 Wireless Telephone is a digital telephone designed to work with IP Office from Release 2.0 and above by connecting to a Digital Station (DS) port. It offers the mobility inherent in a wireless telephone plus access to a number of features and functionality of the connected communications system.

A maximum of 5 Avaya 3810 wireless handsets can be connected to the same IP Office in any overlapping radio coverage area.

This phone is only available in the USA and Canada.

The Avaya 3810 is delivered as a single unit containing:

- Base Unit.
- Handset.
- Telephone Cord.
- Base Unit Power Supply Adapter.
- Charging Stand Power Supply Adapter.
- Rechargeable Battery.
- Belt Clip.
- Charging Stand.
- User and Installation Guide.
- Wall Plate Adapter.

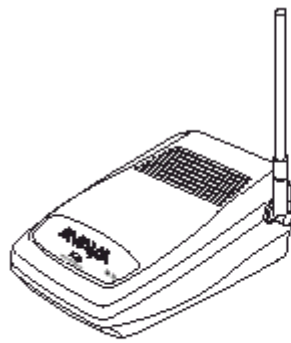

Base Unit



Handset



Telephone Cord

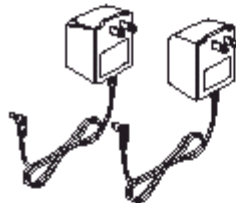

2 AC Adapters



Rechargeable  
Battery



Beltclip

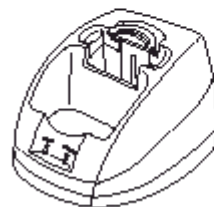

Charger Unit

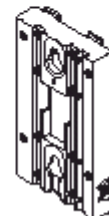

Wall Mount Stand

---

## Business Series Terminal T7406E Cordless Telephone

The T7406E Cordless Telephone is a desk-centric mobility solution, designed for use in a small- to medium-sized enterprise site, branch office or franchise site. The T7406E Cordless Telephone enables businesses to deliver better customer service while making employees more productive with workspace mobility. The T7406E is supported on IP Office modules also supporting the BST digital sets. The T7406E is available in North America, Mexico and Caribbean countries excluding Jamaica and Trinidad.

### Features

An integrated multiline phone, the T7406E leverages the features of the popular Business Series Terminals portfolio and has the following capabilities:

- 2.4 GHz ISM Band
- WiFi-“friendly” technology that enables the product to work in the vicinity of a wireless LAN with no interference
- Frequency-hopping spread spectrum (FHSS) available on 90 channels for each base
- Operating range of 350 meters (1000 feet) in outdoor clear line-of-sight
- 64-bit standards-based security encryption
- Cellphone-like features such as a personal directory, key lock, handsfree speaker, back-light display and keypad, vibration notification
- Maximum site density is two (2) base stations, each accommodating up to four (4) handsets
- Nickel metal hydride battery delivers 4 to 5 hours of talk time or 36 hours of standby time
- Convenient features such as speaker phone, vibrate mode, 20-name directory, out-of-range alert, message waiting and signal strength indicator
- Accessories include a belt clip, handset charging cradle, external battery charger, and AC adaptor



## Digital Mobility Solution

The Digital Mobility Solution is a modular wireless voice communication system that is based on the Digitally Enhanced Cordless Telephony (DECT) technology. Supported on IP Office from Release 7, the Digital Mobility Solution scales from 1 to 64 users and covers an area up to 1.5-million square feet for true campus-wide mobility. The solution consists of the following components:

- Digital Mobility Controller 080/081 (DMC 080 supported in North America; DMC 081 supported elsewhere)
- Digital Mobility Controller 320/321 (DMC 320 supported in North American; DMC 321 supported elsewhere)
- Basestation (4 channel)
- Repeater (2 channel or 4 channel)
- Handsets (3X16 displays)
- Handset Accessories
- OA&M Package
- Service Tool (H/W & S/W) for handsets and repeaters
- Deployment Tool

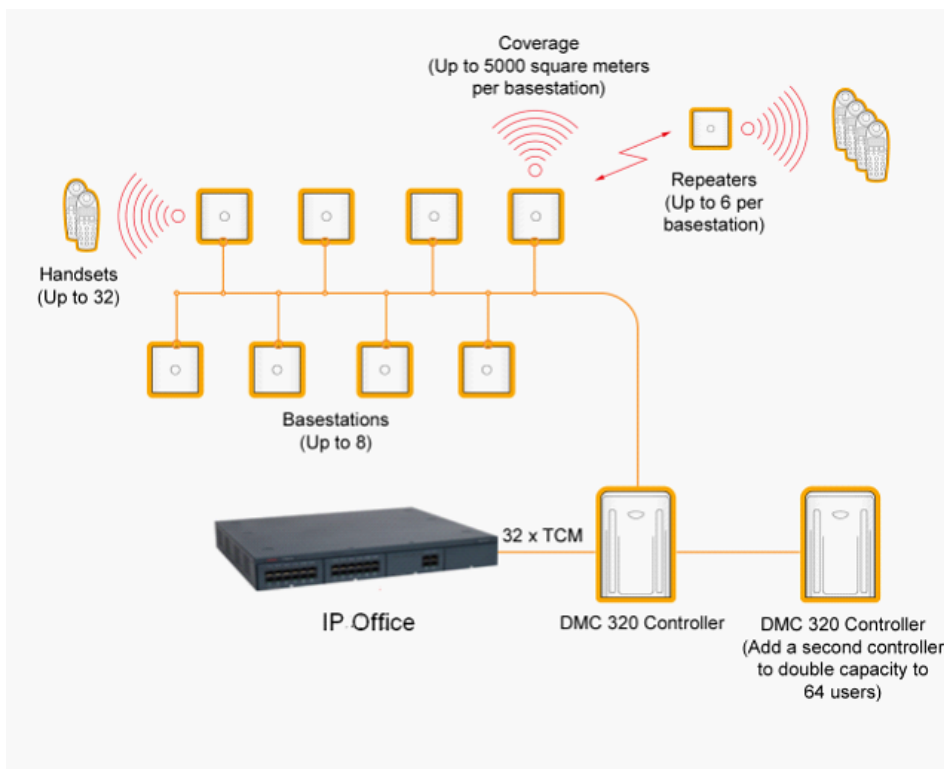

### Connection to IP Office

Connection to IP Office is achieved by using one digital extension connection per DECT phone. The same digital extensions interfaces are required that also support the BST digital telephones like the T7000 series of telephones.

## Digital Mobility Controllers

The following controllers are available within the Digital Mobility offering:

- Digital Mobility Controller 080/081 (DMC 080/081)
- Digital Mobility Controller 320/321 (DMC 320/321)

The Digital Mobility offering has a multi-cell option that allows you to link two DMC units together to effectively double the capacity, delivering up to 5,000 square meters coverage per base station. DMC 080 and 320 are supported in North America. DMC 081 & 321 are supported elsewhere.



*Digital Mobility Controller 080/081 (DMC 080/081)*



*Digital Mobility Controller 320/321 (DMC 320/321)*

The two levels of controllers allow customers to start small and grow their mobility solution to meet their needs today and tomorrow without being charged for additional equipment until the need arises.

The DMC 080/081 will support up to eight handsets and two base stations. Two DMC 080/081 modules can be linked together, if incremental growth is required (2 DMC 080/081 linked together will support 4 base stations and 16 handsets). The DMC 320/321 will support 32 handsets and 8 base stations. The DMC 320/321 can also be linked to expand up to 64 handsets and 16 base stations.

The DMC module provides power to each base station via twisted pair cable. The base station can be located up to 4921 feet (1500 m) from the DMC module. The two-channel repeater is used to extend coverage from a base station, up to 50% additional coverage. Up to six repeaters can be registered to a specific base station to extend the range of a base station. The repeaters are linked to the base station in a wireless manner, so that no physical connection is required. Local power is required for each repeater.

The solution does offer an external antenna which can be used in conjunction with a repeater to extend a base station signal up to 0.62 miles (1 km) away. A typical application would be a campus with multiple buildings requiring coverage.

*Table 1. Coverage Area*

Digital Mobility Solution Configuration	Maximum Number of Base stations	Maximum Number of Users	Maximum Number of Simultaneous Calls	Maximum Coverage: Square Feet	Maximum Coverage: Square Meters
---	---------------------------------	-------------------------	--------------------------------------	-------------------------------	---------------------------------

DMC080/081	2	8	8	180,000	20,000
DMC080/081 + DMC080/081	4	16	16	360,000	40,000
DMC320/321	8	32	32	720,000	80,000
DMC320/321 + DMC080/081	10	40	40	900,000	100,000
DMC320/321 + DMC320/321	16	64	64	1,440,000	160,000

Coverage depends on the environment (including building material and equipment).

## Digital Mobility Base Stations

Each Digital Mobility base station supports up to four simultaneous calls and provides up to 5,000 square meters of coverage (depending on environment). One base station can support up to six repeaters to further extend the Digital Mobility coverage.



*Digital Mobility Base Station*

## Digital Mobility Repeaters

Each Digital Mobility repeater provides two or four channels and supports two or four simultaneous conversations while extending coverage from a base station by providing up to 50 percent additional mobility coverage. Up to six repeaters can be registered to a specific base station in order to further extend base station range. Repeaters are linked to the base station wirelessly, so no physical connection is required. Local power is required for each repeater.

The Digital Mobility solution also includes an external antenna which can be used in conjunction with a repeater to extend a base station signal up to one kilometer away. A typical application would be a campus with multiple buildings requiring coverage.



*Digital Mobility Repeater*

## Digital Mobility Handsets

A portfolio of handsets are supported with the mobility portfolio:

### Digital Mobility Handset 7439

A high value and low cost handset fulfilling all basic requirements for a mobility handset. Targeted at industry, warehouse, and retail segments.

The 7439 is available in North America, and Argentina only. Equivalent handsets include the 4135 (EMEA and Hong Kong) 4136 (Australia and New Zealand), and 7434 (South America).



### Digital Mobility Handset 7449

A classic high-quality rugged handset with a high level of functionality, targeted at office, hospital, and customer support centers. This handset has an IP 54 classification (protection against dust and splashing water).

The 7440 is available in North America, and Argentina only. Equivalent handsets include the 4145 (EMEA and Hong Kong) 4146 (Australia and New Zealand), and 7444 (South America).



### Digital Mobility Handset 4145Ex

The ultimate handset with IP 54 and intrinsic safe classifications. Targeted for use in explosives environments within oil, gas and chemical production.

The 4145Ex and 4146Ex are no longer available for sale.





## Common Handset Attributes

- IP Office feature integration similar like the BST telephones, including 3 soft keys
- Graphical display
- Auto Login - Roaming between 4 different systems
- Headset jack (not included with 7430/4135)
- Loud speaker (Hands free mode) -7440/4145 only
- Telephone book with storage for 80 names and numbers
- Can be set to vibrate mode (not included with 7430)
- Text message capability
- Silent mode (mute all sounds)
- Redial function (last 10 numbers)
- Adjustable volume
- Nine different ring tones
- Key lock
- Microphone mute
- Caller-ID presentation
- Automatic hook-off
- Standby/speech-time: 100/10 hours
- Temperature compensated charging
- Weight including battery is 4.3 ounces (121 grams)
- Size: 5.6" x 1.9" x 1.0" (143 x 48 x 26 mm)

## Digital Mobility Software

The Digital Mobility Solution is supported by an easy to use Operations, Administration, and Management (OA&M) software package, a Mobility Software Service Tool, and a comprehensive Deployment Tool.

### Operations, Administration, and Management Software Package

The OA&M software package allows the following aspects of the Digital Mobility solution to be managed:

- Digital Mobility Controller administration
- Handset registration and subscription
- System backup and restore programming information
- Statistical package for debug
- Broadcasting test messaging
- Updating base station firmware
- Remote system administration via RS232. Optional serial-IP converter

### Mobility Software Service Tool

The Mobility Software Service Tool allows the following aspects of the Digital Mobility solution to be managed:

- Repeater programming
- Handset firmware upgrading

**Note:** Use of this tool requires a programming cable and service tool handset cradle.

### Deployment Tool

The Deployment Tool can be used to assist with challenging deployments. For normal deployments a handset can be used to deploy the Digital Mobility Solution. Each handset can be used to perform the following administrative activities:

- General deployment requirements

- Register master handset
- Register and subscribe handsets
- Subscribe multiple systems
- Base station/Repeater registration

The Deployment Tool and the ability of the wireless handsets to provide coverage information provide effective tools for quick, sure installations and coverage with minimal gaps or costly overlapping. The Deployment Tool provides superior deployment to competitive offerings and will ensure a more cost effective, more accurate installation.

---

## Other Phones Supported

---

The following analog telephones are also supported on IP Office 500 but not all of them are available as new telephones, e.g. the 5600 line of telephones has been discontinued.

Before offering a specific phone please check about availability. The information below about availability is accurate at the launch date of IP Office Released 7 but might change before this product description is updated.

Of course, the standard End of Sale process will apply before any product is discontinued - to make sure the channel has sufficient time to order required materials.

### First generation 9600 telephones:

The first generation of 9600 IP telephones can be an alternative to customers, especially if they are expanding installations that are using these telephones already. A wide choice of models, Color option, Gigabit Ethernet versions:

- The 9620L/9620 C: a member of the Avaya one-X Deskphone Edition family, is specifically designed for the everyday telephone user—those who rely on multiple communications tools such as e-mail and IM, yet still require a high quality and intuitive telephone for voice communications. The 9620L IP Telephone features a high resolution 3.45 inch (9 cm) diagonal monochrome backlit display – while the 9620C features a color display for even better readability. The 9620L/C support up to 12 call appearances / administered feature keys - with three concurrent line appearances visible at any time.
- The Avaya 9650/9650C: The Avaya 9650 IP Telephone, a member of the Avaya one-X Deskphone Edition family, is specifically designed for the "navigator" telephone user. Navigators, such as building receptionists and executive admin staff, frequently manage calls for themselves and for groups of people. The 9650 features built-in button module functionality with one-touch access to bridged appearances, speed dials and feature keys. The Avaya 9650 IP Telephone delivers advanced communications capabilities, high definition audio, an integrated WML application interface, and comprehensive one-touch access. This is the ideal solution for receptionists, executive assistants, contact center agents as well as knowledge workers who need quick access to features and call appearances. The 9650 IP Telephone features a 3.8 inch (9.65 cm) diagonal ¼ VGA quality gray-scale pixel-based display with adjustable angle, while the 9650C enhances usability with a color display for even better readability. The 9650 supports up to 24 call appearances / administered feature keys.
- The Avaya 9630G/9640/9640G: a member of the Avaya one-X Deskphone Edition family, the 9640 IP Telephone with high resolution color display is specifically designed for the executive telephone user. The 9630G IP Telephone features a native Gigabit switch and a 3.8 inch (9.65 cm) diagonal monochrome backlit display - which has been enhanced with higher resolution (1/4 VGA) compared to other available monochrome telephones from Avaya. The 9640 IP Telephone features a 3.8 inch (9.65 cm) diagonal high resolution color backlit display. The 9640G model has the same functionality as the 9640, and adds native support for Gigabit. The 9630/9640 supports up to 24 call appearances/ administered feature keys with six concurrent line appearances visible at any time.

## 5400/2400 Digital Deskphones

The 5400 and 2400 Digital Deskphones offer a broad range of features on IP Office. They are supported on IP Office Release 8.0, but they are no longer for sale.

## 5402, 5602 SW, 2402, 4602 SW Telephone

These telephones are best suited for the Walkup User.



Telephone	Works on IP Office	Works on IP Office and Communication Manager
5402	✓	✗
5602 SW	✓	✗
2402	✓*	✓
4602 SW	✓	✓

\*Early 2402 telephones can make and receive call but the display will not function.

**Note:** The 5602 SW and 4602 SW telephones are supported by IP Office Release 6 but are no longer available for new sales.

### Common Features

**Display:** 2 lines x 24 characters.

**Fixed Feature Buttons:** 10 - Conference, Transfer, Drop, Redial, Speaker, Messages, Hold, Mute, Volume Up, Volume Down.

**Programmable Feature Buttons:**

- **DS telephones:** 2 plus an additional 12 programmable feature keys can be accessed via the **FEATURE** key.
- **IP telephones:** 2.

**Key Labels:** Icons and text used on fixed feature keys. Display labels and icons used on 2 programmable feature keys.

**Speakerphone:** Listen-only handsfree speaker (no microphone).

**Hearing Aid Compatible:** Yes.

**Message Waiting Indicator:** Yes. On the 2402 and 5402 this is can also be used as a ringing call alert indicator.

**Personalized Ring Patterns:** Yes- 8 (via Conference button when idle).

**Headset Socket:** No, this telephone does not support headset operation.

**Embedded Applications:** None.

- **Upgradeable Firmware:** DS telephones - No. IP telephones - Yes.
- **Expansion:** None.
- **Color:** Multi-gray.
- **Mounting:** Desk or wall mountable.

- **Adjustable Desk Stand:** No.

### Requirements for 5402 and 2402

**Connect to:** Digital Station (DS) port.

**Power Supply:** From phone system.

### Requirements for 5602 SW and 4602 SW

**Power Supply:** IEEE 802.3af Power over Ethernet (PoE) or individual power supply unit (Avaya 1151 Series).

**Codecs:** G.711, G.729a/b.

**QoS Options:** UDP Port Selection, DiffServ and 802.1p/q (VLAN)

**SNMP Support:** Yes.

**IP Address Assignment:** Static or dynamic IP address assignment.

**Ethernet Ports:** Two port full-duplex 10/100 BaseT Ethernet switch for PC pass-through connection.

- Auto-negotiation provided separately for each port.
- 802.3 Flow Control.
- Phone has priority over PC port at all times.

## 5410, 5610 SW, 2410, 4610 SW Telephones

These telephones are best suited for the Receptionist/Assistant User.



Telephone	Works on IP Office	Works on IP Office and Communication Manager
5410	✓	✗
5610 SW	✓	✗
2410	✓	✓
4610 SW	✓	✓

Note that 4610, while supported on IP Office R6, is not longer available for new sales

### Common Features:

- **Display:** 5 lines x 29 characters (168 x 80 pixel 4-grayscale).
- **Fixed Feature Buttons:** 10 - Conference, Headset, Transfer, Drop, Redial, Speaker, Hold, Mute, Volume Up, Volume Down.
- **Programmable Feature Buttons:**
  - **DS telephones:** 12 - in 2 switchable display pages of 6 matching the 6 physical display buttons.
  - **IP telephones:** 24 - in 4 switchable display pages of 6 matching the 6 physical display buttons.
- **Key Labels:** Icons and text used on fixed feature keys.
- **Speakerphone:** Two-way handsfree speaker and microphone.
- **Hearing Aid Compatible:** Yes.
- **Message Waiting Indicator:** Yes - can also be used as a ringing call alert indicator.
- **Personalized Ring Patterns:** Yes - 8.
- **Headset Socket:** Yes.
- **Embedded Applications:** Speed Dial List (48) and Call Log (Missed, Incoming, Outgoing). Also WAP WML browser supported on IP phone models.
- **Upgradeable Firmware:** Yes.
- **Expansion:** None.
- **Color:** Multi-gray.
- **Mounting:** Desk or wall mountable.
- **Adjustable Desk Stand:** Yes - Supplied with phone.

### Special Features for the 5410 and 2410:

- **Messages Button:** Dedicated button to collect voicemail.

### Requirements for 5410 and 2410:

- **Connect to:** Digital Station (DS) port.
- **Power Supply:** From phone system.

**Requirements for 5610 and 4610:**

- **Power Supply:** IEEE 802.3af Power over Ethernet (PoE) or individual power supply unit (Avaya 1151 Series).
- **Codecs:** G.711, G.729a/b.
- **QoS Options:** UDP Port Selection, DiffServ and 802.1p/q (VLAN)
- **SNMP Support:** Yes.
- **IP Address Assignment:** Static or dynamic IP address assignment.
- **Ethernet Ports:** Two port full-duplex 10/100 BaseT Ethernet switch for PC pass-through connection.
  - Auto-negotiation provided separately for each port.
  - 802.3 Flow Control.
  - Phone has priority over PC port at all times.

## 5420, 5621, 2420, 4621, 4625 Telephones

These telephones are best suited for the Executive User and with the optional EU24 Button Module good for the Receptionist/Assistant User.



Telephone	Works on IP Office	Works on IP Office and Communication Manager
5420	✓	✗
5621 SW	✓	✗
2420	✓	✓
4621 SW	✓	✓
4625 SW	✓	✓

Note that 4621 and 4625, while supported on IP Office R7, but are not longer available for new sales.

### Common Features:

**Display:** 7 lines x 29 characters.

**Fixed Feature Buttons:** 10 - Conference, Headset, Transfer, Drop, Redial, Speaker, Hold, Mute, Volume Up, Volume Down.

#### Programmable Feature Buttons:

- **DS telephones:** 24 - arranged in 3 switchable display pages of 8 matching the 8 physical display buttons.
- **IP telephones:** 24 - arranged in 2 switchable display pages of 12 matching the 12 physical display buttons.

**Key Labels:** Icons and text used on fixed feature keys.

**Speakerphone:** Two-way handsfree speaker and microphone.

**Hearing Aid Compatible:** Yes.

**Message Waiting Indicator:** Yes - can also be used as a ringing call alert indicator.

**Personalized Ring Patterns:** Yes - 8.

**Headset Socket:** Yes.

**Embedded Applications:** Speed Dial List (104) and Call Log (Missed, Incoming, Outgoing). Also WAP WML browser supported on IP phone models.

**Upgradeable Firmware:** Yes.

**Expansion:** Supports the EU24 DSS expansion module (with additional Avaya 1151 power supply).

**Color:** Multi-gray.

**Mounting:** Desk or wall mountable.

**Adjustable Desk Stand:** Yes - Supplied with phone.



## Special Features for the 5420 and 2420

**Messages Button:** Dedicated button to collect voicemail.

## Requirements for 5420 and 2420

**Connect to:** Digital Station (DS) port.

**Power Supply:** From phone system.

## Requirements for 5621 SW, 4621 SW, 4625 SW

**Power Supply:** IEEE 802.3af Power over Ethernet (PoE) or individual power supply unit (Avaya 1151 Series).

**Codecs:** G.711, G.729a/b.

**QoS Options:** UDP Port Selection, DiffServ and 802.1p/q (VLAN)

**SNMP Support:** Yes.

**IP Address Assignment:** Static or dynamic IP address assignment.

**Ethernet Ports:** Two port full-duplex 10/100 BaseT Ethernet switch for PC pass-through connection.

- Auto-negotiation provided separately for each port.
- 802.3 Flow Control.
- Phone has priority over PC port at all times.

## Special Features for 5621 SW and 4621 SW

**Display Backlight:** The display has a backlight for improved contrast. Standby mode turns off backlight after time-out.

## Special Features for 4625 SW

**Color Backlight Display:** The display is full color and has a backlight for improved contrast.

**Note:** While still supported, the 5620SW and 4620SW telephones are no longer available for purchase.

## EU24 and EU24 BL Expansion Modules



The EU24/EU24BL are phone expansion modules that work in association with a 5420, 5620/1, 2420, 4620/1, 4625 telephones. They provide an additional 24 programmable buttons with associated display label and status icons. Only one EU24 can be used per phone. The EU24BL has a backlight and is for use with the 4621 and 5621 only.

The EU24/EU24BL supports an additional 24 Call Appearance/Feature buttons, by displaying a column of 12 buttons at a time, with a dotted line separating the two columns.

### Common Features

- 24 Programmable call appearance/feature keys.
- Automatically labeled from the system (no paper labels).
- Connects directly to the associated phone.
- Requires an Avaya 1151 Series power supply, even for IP telephones already using Power over Ethernet (PoE).
- IP Office supports a maximum of eight EU24/EU24 BL's on each IP Office system, subject to total system limits.

Telephone	EU24	EU24BL
2402/5402	✗	✗
2410/5410	✗	✗
2420/5420	✓	✗
4601/5601	✗	✗
4602/5602	✗	✗
4610/5610	✗	✗
4620/5620	✓	✗
4621/5621	✓	✓
4625	✓	✓

Note that EU24 BL, while supported on IP Office R6, is not longer available for new sales.

---

## 1100 and 1200 IP Phones

The 1100 IP telephones are inherited from the Norstar and BCM product line. These telephones are supported on the BCM platform using "UNISTim" protocol.

On IP Office these telephones are supported using the SIP protocol. SIP software can be downloaded onto those telephones when they get connected to IP Office. When used with IP Office, the telephones need an "Avaya IP phone" license like any other Avaya IP phone. No other license is needed (e.g. with IP Office no separate IP-phone license is required).

The following telephones can be migrated:

- 1100 Series: 1120E and 1140E plus Key Expansion module
- 1200 Series: 1220 and 1230 plus both Key Expansion modules.

Please note that for new installs Avaya recommends the 9600 line of telephones like the 9608, 9621 or 9641. They telephones offer the full access to all innovative IP Office features like Visual Voice-Mail, IP Office Feature menu or centralized call-logs or personnel directories.

## 1100 and 1200 IP Phones Overview

Users can enjoy the next-generation features of VoIP, plus all of the carrier-class reliability and ease of use of traditional telephones. These telephones offer four superior desktop models, along with two innovative software-based solutions that bring VoIP to a user's computer or PDA. The IP telephones include:

- **IP Phone 1100 Series** – The IP Phone 1120E and 1140E are IP color display telephones. They offer a fully pixel-based, high-resolution, backlit display. They are optimized for Web-centric applications such as phone support under XAS/G-XAS. They also provide USB support for peripherals such as a keyboards or mouse.
- Key Expansion Module for the IP Phone 1100 Series – The Expansion Module for IP Phone 1100 Series is a hardware accessory that will provide up to 18 additional line / programmable feature keys per module. The module is supported on the IP Phone 1120E and the IP Phone 1140E.
- IP Phone 1200 Series – The IP telephones 1220, and 1230 are BCMs family of IP Phone tailored for the SMB market and now also supported on IP Office. They provide a rich set of capabilities at a price competitive for the SMB market.
- Key Expansion Module for the IP Phone 1200 Series – The Expansion Module for IP Phone 1200 Series is a hardware accessory that is available in two options. A 12 key LCD based model or a 18 key based LED module. The modules are supported on the IP Phone 1220 and the IP Phone 1230.
- Please note that **the following telephones, available with BCM, are not supported on IP Office:** 1210, 1110.

## IP Phones Benefits

- Support connectivity to heritage Nortel VoIP enabled platform, including BCM and Communication Server 1000 using UNISim as well as IP Office using the SIP protocol
- Transnetwork support increases employee productivity by providing users and network managers with a common set of telephones across the entire network
- Internal voice/data switch prioritizes voice traffic to ensure high-quality speech and reduces costs by conserving wiring closet ports and eliminating the need for separate cable drops to the desktop
- Automatic firmware upgrade ensures top performance and streamlines maintenance, reducing the need for site visits
- DHCP enabled IP telephones simplify network administration by providing centralized, automated IP address management

### Multiple Platform Support

These IP telephones are supported by heritage Nortel communication systems, including BCM, and Communication Server 1000 but now are available also for IP Office. This industry-leading platform interoperability facilitates growth and offers seamless migrations across customer premises and carrier-based solutions. All IP telephones offer a rich suite of business features designed to meet current and emerging user requirements and international icon-based characters. These features, in addition to multilanguage support, make the IP telephones ideal for worldwide use.

### Integrated Switched Ethernet Connection

Users can connect their desktop Internet telephone and their PC to the network on a single port. The IP telephones feature a built-in 10/100 Base T Layer 2 switch that splits the network Category 5 cable into separate feeds, one to the phone itself, while providing an additional RJ-45 port to connect a user's PC. Giving fixed, hardware-based priority to the phone voice port, the internal Ethernet switch ensures that high-quality voice service is always available.

### Reliable LAN Power Options

To ensure continuous phone service in mission-critical environments, the IP telephones can receive their power over the network cabling. The Avaya family of Ethernet Switches (BES 50, ERS2500, ERS4500) delivers power over the unused pairs of standard Category 5 UTP cables, eliminating the need for the telephones to be connected to a power supply at the desktop.

Power is supplied on an as-needed basis, thanks to the sophisticated, software based load and fault-sensing algorithm used by the Avaya Ethernet Switches. Desktop, rackmount and stackable options are available which provide a cost-effective way to centralize power to the IP telephones. This approach delivers carrier-grade reliability by enabling redundant power resources located at the wiring closets to provide emergency backup power to these IP telephones located across the network.

### Dynamic Host Configuration Protocol

Easy to set up and configure, the IP telephones deliver an innovative solution that enables users to connect anywhere on the network without intervention by a network administrator, enabling management staff to focus on more complex, mission-critical responsibilities.

Whether users relocate their phone down the hall or across the globe, the service comes up in the new location exactly as if they were sitting in their own office, even though it might be thousands of miles away.

### Prioritizing Network Traffic

Now companies can make their network's priorities mirror those of their business. By installing the Avaya Ethernet Switch (BES50 or ERS), a business' network becomes an intelligent partner that uses Layer 2/3 packet classification to prioritize business-critical traffic, helping them get the most out of their existing infrastructure.

Latency-sensitive applications and mission-critical users will receive platinum-level service, while less urgent traffic is allocated bandwidth on a lower-priority basis. Prioritization is especially important for businesses that need to support mission-critical IP applications, including VoIP, but do not want to incur higher costs by overprovisioning the network to ensure bandwidth availability.

## Universal Features

With over 100 years of experience in creating telephones designed to improve employee productivity, reduce operational expenses and improve customer service, Avaya is the industry leader in telephony solutions. All of the IP telephones offer the following features:

- Intuitive navigation cluster provides fast menu, sublist and call log scrolling, as well as one-touch dialing and quick access to system features
- Message waiting/visual ring indicator offers visual notification of incoming calls and messages
- Voice compression optimizes bandwidth and audio quality requirements
- Audio control center enables users to toggle quickly between the handset or headset and the speakerphone without audio interference
- Volume bar provides fingertip control of audio and ringer volume settings and LEDs clearly display handset/ headset/speakerphone/mute settings
- Local tone generation conserves valuable network bandwidth
- Dynamic IP addressing with a standard DHCP server offers a flexible, simplified solution for handling adds, moves and changes, reducing management costs
- User-friendly design supports the full range of potential users, including disabled users who require hearing aids.

## SIP Protocol: Feature overview on IP Office with 1100/1200 phones

The 1100 and 1200 Series phones are supported on IP Office using the SIP protocol, therefore the user interface can be slightly different then when used on BCM with UNISim. For example, on IP Office, the 1100 and 1200 Series IP phones only support a single call appearance (although multiple calls are supported).

Note that these telephones are only supported on IP Office 500/500 V2 hardware.

They support a large set of features including:

- Standard phone features like hold, transfer, conference (IP Office based)
- A single call appearance (note that currently bridged appearances and trunk-line appearances are not supported)
- Message waiting support
- Busy Lamp keys with speed-dial, status indication and pickup of ringing calls
- Application support. The telephones can be used in combination with applications like Avaya one-X™ Portal for IP Office for added comfort, allowing e.g. click and dial functionality.
- Self labeling Feature keys: This allows access to selected IP Office features using a single key-press. If additional parameters are needed, the user is guided using a dialog interface of feature request plus softkeys for e.g. confirmation
- "Special" feature key. The supported features are also available pressing a "feature" (soft-) key plus the appropriate feature code. The feature codes are identical to the features codes from BCM, therefore making transition easy and painless.
- Ease of installation: The telephones can be managed from IP Office manager and are easily installed. IP Office will serve as DHCP-server and can provide configuration files, software updates etc. To install the telephones, only IP Office manager is needed.
- When migrating telephones from BCM to IP Office, when IP Office DHCP server is used, the system will take care of installing/upgrading the telephones to the correct software for IP Office. This makes migration easy and quick.

With IP Office Release 8.0, the SIP 4.3 firmware becomes available with the following enhancements:

- Removal of the requirement to press the 'Send' key in order for the phone to start dialing (1-10 sec timeout - default = 5 sec)
- Avaya one-X™ Portal for IP Office integration: hold/mute & conference supported
- Language selection via IP Office Manager is now supported

## Feature Table:

(next to the features that are accessible through the "Feature key" and that can be administered to a button, the telephones can also access IP Office features by dialing the IP Office Feature Access code--plus parameter if needed--for the desired feature.)

Feature	Details
F*0 – Button query (also allows DN query via I/C button)	supported
F*1, F*2, F*3 – Self-admin button programming	supported
F*6 – Self-admin ring type	function supported on the phone but not using the feature code
F*7 – Self-admin contrast	function supported on the phone but not using the feature code
F*80 – Self-admin ring volume	function supported on the phone but not using the feature code
F0 – Speeddial	supported
F3 – Conference, Conference Add, Conference Meet Me	supported
F4 – Call Forward, F#4 cancel, Call Forwarding All	supported
F5 – Last Number Redial	supported
F60 – Page (no F61-F63)	supported
F66 – Dial Voice Call	supported
F70 - Transfer	function supported on the phone but not using the feature code
F74 – Call Park/Unpark, F#74 Retrieve	supported
F75 – Call Pickup Group	supported
F76 – Call Pickup Extn	supported
F85 – Do Not Disturb, F#85 cancel	supported
F981 – Enter Voicemail System (same as F65) AUDIO ONLY	supported
F812 – Call Log	function supported on the phone but not using the feature code
Account Code Entry	supported
After Call Work	supported
Automatic Callback	supported
Automatic Intercom - Dial voice call	supported
Call Record	supported
Cancel All Forwarding	supported
Directed Call Pickup	supported
Extension Login, Extension Logout	supported
Follow Me Here, Follow Me Cancel, Follow Me To	supported
Forward Number, Forward Busy Number, Forward On Busy, Forward On No Answer, Forward Unconditional	supported
Private Call	supported
Relay On, Relay Pulse	supported
Set HG:	supported

Feature	Details
- Night Service - Out of Service - NS Group - OOS Group	
Twinning	supported
Voicemail ON	supported



## Avaya IP Phones 1120E and 1140E



*IP Phone 1120E*

*IP Phone 1140E*

The Avaya IP telephones 1120E and 1140E offer an IP desktop solution that is optimized for Web-centric applications such as phone support, and other multimedia options. They feature Gigabit Ethernet, USB connectivity, and an ergonomic design and cable management that make them easy to set up and maintain. The 1120E and 1140E IP telephones are supported on IP Office R6.1 and higher

### Phone 1120E

The IP Phone 1120E provides the following features:

- A multi-line phone with four programmable line/feature key appearances
- High-resolution backlit graphical pixel-based display
- Adjustable five-position tilt-stand (-5° to + 55°), plus vertical design for smaller desktop footprint
- Fourteen fixed keys and four soft keys
- 10/100/1000 Base-T with integrated PC & LAN Ports
- XAS/G-XAS supports data applications and Web browsing
- USB port for enhanced navigation and productivity
- Expansion Module/Console Port
- Visual Alerting and Feature Status Indicator Lamps
- Integrated headset port for optional wired Headset
- Active Ethernet link LED indication
- Secure Tools Menu facilitates access to preferences & administration
- 802.3af PoE (Class 3) or local power options
- Desk and Wall Mountable
- Color: Graphite with Silver Metallic Bezel

### IP Phone 1140

The IP Phone 1140E provides the following features:

- Multi-line phone, with up to 12 programmable line/feature keys
- High-resolution backlit graphical pixel-based display
- Adjustable five-position tilt-stand (-5° to +55°)
- Fourteen fixed keys and four soft keys
- Integrated Bluetooth radio for office and home-based mobility
- 10/100/1000 Base-T with integrated PC & LAN Ports
- XAS/G-XAS supports data applications and web browsing
- USB port for enhanced navigation and productivity
- Visual Alerting and Feature Status Indicator Lamps
- Expansion Module/Console Port
- Integrated headset port for optional wired Headset
- Active Ethernet link LED indication
- Secure Tools Menu facilitates preferences & administration
- Global Character Sets

- 802.3af PoE or local power option
- Color: Graphite with Silver Metallic Bezel

### IP Key Expansion Module for IP Phone 1100 Series



IP Phone 1100 Series  
Expansion Module

The IP Phone 1100 Series includes a Key Expansion Module that provides up to 18 additional line/programmable feature keys per module. The module is supported on the IP Phone 1120E and the IP Phone 1140E.

### Avaya IP Phones 1220 and 1230



IP Phone 1220 with LED expansion module



IP Phone 1230

The IP Phone 1200 Series, a group of IP telephones Launched with BCM are now also available with IP Office. They are tailored for the SMB market. The 1200 Series provides a range of different telephones designed to address the needs of the SMB market with a broad feature set at competitive prices.

IP Phone 1220 is an intermediate IP phone targeted at most SMB employees. The IP Phone 1230 is a premium IP phone for managers and advanced/power users.

#### IP Phone 1220

The IP Phone 1220 provides the following features:

- A five-line display with 25 characters per line
- A fixed stand with two positions, plus vertical design for smaller desktop footprint
- Eight fixed keys, with three having LED status
- Hands free, Mute, Headset, Volume Controls, Hold, Goodbye, Applications.
- Six feature keys
- Four context-sensitive soft keys

- Four line/feature keys
- 10/100 Base-T with integrated PC Port
- Active Ethernet link LED indication
- Integrated headset port for optional wired Headset
- Compatible with optional Key Expansion Modules
- Visual ringing alerter / Message Waiting Indicator
- 802.3af PoE (Class 2) or optional AC local power options
- Wall Mountable

## IP Phone 1230

The IP Phone 1230 provides the following features:

- A nine-line display with 25 characters per line
- A fixed stand with two positions, plus vertical design for smaller desktop footprint
- Eight fixed keys, with three having LED status
- Handsfree, Mute, Headset, Volume Controls, Hold, Goodbye, Applications.
- Six feature keys
- Four context-sensitive soft keys
- 10 line/feature keys
- 10/100 Base-T with integrated PC Port
- Active Ethernet link LED indication
- Integrated headset port for optional wired Headset
- Compatible with optional Key Expansion Modules
- Visual ringing alerter / Message Waiting Indicator
- 802.3af PoE (Class 2) or optional AC local power options

## IP Key Expansion Modules for IP Phone 1200 Series



*LCD IP Key Expansion Module*



*LED IP Key Expansion Module*

The IP Phone 1200 Series includes two Key Expansion Modules to provide flexibility for adding more keys to the IP Phone 1220 and IP Phone 1230. The extra keys can be used for additional line appearances or to add often-used features for quicker access. The keys can also be programmed as auto-dialers for one-touch calling, and will provide busy lamp field indication for users on the BCM system. This allows these telephones to better serve the needs of attendant and receptionist functions, and increase productivity for any user. Key features include:

- LCD Expansion Module for the IP Phone 1200 Series offers 12 keys per module, cascadable to 7 LCD KEMs on an IP Phone 1220 or 1230

- LED / Paper Label Module for the IP Phone 1200 Series offers 18 keys per module, with LED indicators for line status and an easy-to-use paper labeling system, cascable to 2 LED Paper-Label KEMs on an IP Phone 1220 or 1230.

---

## **BST T7000 and M7000 Series - Digital Deskphones**

Business Series Terminals offer a feature-rich portfolio with enhanced capabilities that provide telephony solutions for a broad landscape of users, from high-volume call positions and executives to low-intensive users and small workgroups.

The Business Series Terminals were originally positioned for deployment on two system platforms from the Nortel Heritage, Norstar and BCM, providing both investment protection and a migration path between either system. The Business Series Terminals offer full integration with Norstar and BCM features, as well as integration with basic and advanced applications such as Messaging, Intelligent Contact Center, Computer Telephony Integration (CTI) and integrated voice and data solutions.

The telephones are now available also on IP Office and offer customers primarily another migration option from Norstar or BCM to IP Office.

Please note that those terminals do not work on all digital ports of IP Office but require a specific 8-port expansion card or 16/30 port expansion module: For details refer to the IP Office hardware segment:

Recommendation: The BST digital phone support on IP Office is mainly intended for migration from Norstar to BCM. For new installs, it is possible to use the BST telephones. For new installs Avaya recommends using the 1400 or 9500 digital sets in order to get access to all advanced features of IP Office like Visual Voice, Feature menus or self labeling keys (9500 telephones only)

## Product Overview

While the Business Series Terminals boast the industry leadership and strengths of the BCM and Norstar telephone portfolio, the portfolio also delivers value-added features. These telephones are now also supported on the IP Office platform. Feature highlights include:

- Tilt Display – provides clearer viewing of information or message prompts on the LCD in different lighting environments.
- Message waiting indication/Visual ringing lamp – alerts the user of incoming messages or that their phone is ringing when they are on another call.
- Headset interface – is driven from the Digital Terminal Interface Chip (DTIC). Volume control for the headset is also provided. Operation of the headset is mutually exclusive, with Handsfree operation. When a headset is connected, all operations normally associated with handsfree operation affect the headset. This includes on-hook dialing, volume control while active and muting.
- Handsfree interface – is programmed through the administration function and is supported by a microphone and loudspeaker.
- External ringer interface – receives alerting signals that are routed to the external ringer jack as well as to the speaker in the telephone. This alerting signal can be amplified and connected to external speakers to provide an auxiliary ringer function for the telephone. The external speaker is connected with a two-wire modular telephone cord to pins 3 and 4 of the external ringer jack.

The portfolio also offers tilt display, new aesthetics, a streamlined footprint, new labeling strategy, an audio control center with a headset button and more.

Sets are available in the following colors:

- Platinum
- Charcoal (not T7000)

On IP Office, the following features are available using the "feature key" and the Feature access code inherited from Norstar/BCM: Other IP Office features are also available by dialing the IP Office Feature Access code:

F\*0 – Button query (also allows DN query via I/C button)

F\*1, F\*2, F\*3 – Self-admin button programming

F\*6 – Self-admin ring type

F\*7 – Self-admin contrast

F\*80 – Self-admin ring volume

F\*82 – Dial mode selection (Enbloc/Pre-dial [editable], or Standard/Overlap dial)

F\*84 – Set call log options (All, Missed, Answer, Outgoing) (we've concluded that this adds no value)

F0 – Speeddial

F2 – Ring Again, F#2 cancel

F3 – Conference

F4 – Call Forward, F#4 cancel

F5 – Last Number Redial

F60 – Page (no F61-F63)

F65 – Retrieve Messages - Enters Voicemail System on IP Office (Basic Embedded Voicemail)

F66 – Dial Voice Call

F69 – Dial Priority Call

F70 - Transfer

F74 – Call Park, F#74 Retrieve

F75 – Call Pickup Group

F76 – Call Pickup Extn

F85 – Do Not Disturb, F#85 cancel

F981 – Enter Voice Mail System (same as F65) **AUDIO ONLY**

F812 – Call Log

F802 – Group Listen, F#802 cancel

## T7000



The T7000 telephone is an entry-level digital set for basic low-use office environments. It has four programmable feature keys. It does not have display buttons (soft keys), and it does not support headset or Handsfree.

The T7000 is used primarily in the EMEA (not available in North America).

The T7000 supports the following features:

- External ringer interface
- Message waiting indicator/visual ringing lamp
- Dial-up feature access

### **Button Matrix**

The T7000 buttons are as follows:

- Twelve dial pad buttons
- Volume control (rocker type)
- Hold button
- Release button
- Feature button
- Four programmable button



## T7100



The T7100 telephone is part of the Business Series Terminals portfolio. It has one programmable button and a 1 x 16 character alphanumeric display to provide call progress information. There are no display buttons (soft keys) on the T7100 and it does not support headset or Handsfree.

T7100 supports the following features:

- External ringer interface
- Message waiting indicator/visual ringing lamp
- LCD with tilt Display – The one-line by 16-character display on the T7100 telephone provides call progress information. Each character is generated from a matrix of 5 x 7 LCD dots under control of a built-in controller chip on the module.

### **Button Matrix**

The T7100 buttons are as follows:

- Twelve dial pad buttons
- Volume control (rocker type)
- Hold button
- Release button
- Feature button
- One programmable button

### **Loop Limits**

- Maximum loop length – 305 m (1000 ft) on 0.5 mm (24AWG) wire
- Maximum loop length – 790 m (2600 ft) with SAPS option
- Bridge taps – not permitted; loading coils – not permitted.

## T7208



The T7208 telephone is part of the Business Series Terminals portfolio. It has eight fully programmable buttons, each with its own LCD indicator and a 1 x 16 character alphanumeric display to provide call progress information. There are no display buttons (soft keys) on the T7208.

The T7208 supports the following features:

- External ringer interface
- Headset interface
- Handsfree interface
- Message waiting indicator/visual ringing lamp
- LCD with tilt Display – The one-line by 16-character display on the T7208 telephone provides call progress information. Each character is generated from a matrix of 5 x 7 LCD dots under control of a built-in controller chip on the module.

### **Button Matrix**

The T7208 buttons are as follows:

- Twelve dial pad buttons
- Volume control (rocker type)
- Hold button
- Release button
- Feature button
- Eight programmable buttons with indicators.

### **Loop Limits**

- Maximum loop length – 305m (1000 ft) on 0.5 mm (24 AWG) wire
- Maximum loop length – 790 m (2600 ft) with SAPS option
- Bridge taps – not permitted; loading coils – not permitted.

## T7316E



The T7316E telephone is part of the Business Series Terminals portfolio. It has 24 programmable buttons and a 2 x 16 character alphanumeric display that is menu driven and supported by three context-sensitive soft keys. The T7316E provides access to 24 memory buttons, 16 of which include multi-segment icons for fast and precise decision-making.

The T7316E supports the following features:

- Multi-line w/multi-segment call appearance icons
- 16 programmable buttons for lines/features/autodials
- 8 additional memory buttons for features/autodials
- Expandable by adding T24 KIM
- Integrated BLF/DSS
- Fixed buttons: feature, hold, release
- Two-line adjustable display w/soft keys
- Built-in speakerphone
- Message Waiting Indication
- Time and date displayed
- Built-in headset
- Audio control center with mute, hands free, headset and volume bar
- Default features based on profiles
- Default line and hunt group assignment
- Retractable quick reference card
- Desk or wall mount
- Hearing aid compatible
- Desktop Assistant label application compatible
- ITU dial pad
- Colors: charcoal and platinum
- English and French keycaps (accessory)
- Extra length 2.7m handset cord (accessory)
- Shoulder rest (accessory)

## BST Central Answering Position (T7316E + T24)



The BST Central Answering Position is an expandable desktop telephone that allows administrative assistants and emergency contact centers the ability to centralize and efficiently distribute calls. By attaching the T24 Key Indicator Module (KIM) directly to the T7316E, office administrators and emergency contact centers can transform the pace and efficiency of their operations while maintaining an exceptional level of customer service.

IP Office does have the concept of Ordinary KIMs and Enhanced KIMs; all buttons can have line appearances. On IP Office there is an overall system limit of 1024 buttons of any kind of expansion module (Digital + IP).

### **T24 Product features:**

- BCM and Norstar compatible
- Two versions of the T24 are available (Enhanced for line appearances and Ordinary for features and autodialers)
- Multi-line with multi-segment call appearance icons
- 24 programmable buttons for lines/features/autodials
- Busy Lamp Field/Direct Station Select support
- Multiple appearances of hunt groups
- Multiple line appearances
- 4 T24's per T7316E without power supply
- 9 T24's per T7316E with power supply
- Desk or wall mount
- Colors: charcoal and platinum

## M7000

The IP Office TCM8 module and DS16A/30A modules also support the Norstar and BCM M7000 Series Digital Telephone sets.

The following M7000 Series are supported on the IP Office R7.0 and later:

<b>Avaya M7000 Series Digital Deskphones</b>	
M7100	
M7100N	
M7208 global	bottom button is dedicated HF
M7208N	bottom button is dedicated HF
M7310 global	bottom right button is dedicated HF
M7310 global + BLF module	bottom right button is dedicated HF
M7310N	bottom left button is dedicated HF
M7324 global	bottom right button is dedicated HF
M7324N	bottom right button is dedicated HF

Only the Global version of the M7000 Series will be supported on the IP Office. The Non-Global version (also called NA version) of the M7000 Series set is not supported on the IP Office. The Non-Global versions were available from the late 1980s to the early 1990s and only sold in North America. The Global version was available in all regions including NA as of the Early-Mid 1990s until the End of Sale of the M7000 Series sets.

The Global and Non-Global sets can best be identified through their contrast level:

- Global version – 9 Contrast Levels
- Non-Global version – 4 Contrast Levels

Avaya recommends that Avaya partners make the end-customers aware that the M7000 have reached the End of Life status and hence technical support for them is limited.

### **Message Waiting Indication (MWI) for M7000 Series set on IP Office**

The M7000 Series Sets have no designated MWI Light, but users have two options to receive MWI on these sets on the IP Office.

- Indicator Button programmed with F65 or F981 - Indicator lamp will lit when a new VM is available. This option is not available for the M7100 Set since it has no programmable indicator button.
- Voicemail Ringback Feature – when enabled the IP Office will ring the set once set is active again (lift handset or call placed) to notify about the available VM. The feature is disabled by default.

Once the M7000 Series Sets are connected to the IP Office they will not display "Message(s) for you" on the display when a message is available.

---

## Avaya Audio Conferencing Unit

The Avaya Audio Conferencing Unit offers superior teleconferencing by using three microphones to provide 360 degrees of voice coverage. The Conferencing Unit is a full duplex handsfree unit. This feature allows voice to be heard and picked up at the same time, providing faster response time and eliminating conversation "collisions" and losses. The unit has a Feature Key that allows access to many of the same features found on the Business Series Terminals. The Conferencing units connects to the same digital ports of IP Office that are also supporting BST terminals.



---

## Button Modules

IP Office supports a number of different button modules to provide telephones with additional programmable buttons. The limits stated below are those applicable for the IP Office 4.2 2Q 2009 maintenance release and higher.

- BM32: (1616)  
Up to 32 BM32s supported (32 buttons each, up to 1024 buttons).
- DSS4450: (4412D+, 4424D+)  
Up to 8 DSS4450 modules per system (maximum of 2 per DS expansion module, including the IP406v2) (50 buttons each, max 400 buttons).
- DBM32: (1416)  
Up to 32 DBM32s supported (32 buttons each, up to 1024 buttons).
- EU24/EU24BL: (4620, 4621, 5420, 5620, 5621, 4620, 4621, 5620, 5621)  
Up to 8 EU24s per system (24 buttons each, max 196 buttons).
- SBM24: (9630G, 9640, 9640G, 9650, 9650C)  
Up to 42 SBM24s per system (24 buttons each, up to 1008 buttons).
- BM12: (9508, 9608, 9611, 9641)  
Up to 42 SBM24s per system (24 buttons each, up to 1008 buttons).
- BM12: (9608, 9611, 9641)  
Up to 42 SBM24s per system (24 buttons each, up to 1008 buttons).
- LCD IP key Expansion module for 1200 telephones (1220, 1230)  
Up to 82 LCD-IP KEMs per system (12 buttons each, up to 1008 buttons).
- LED IP key Expansion module for 1200 telephones (1220, 1230)  
Up to 56 LED-IP KEMs per system (18 buttons each, up to 1008 buttons).
- LCD IP key Expansion module for 1100 telephones (1120, 1140)  
Up to 56 LCD-IP KEMs 24s per system (18 buttons each, up to 1008 buttons).
- T3 Series: (All T3 telephones)  
Up to 30 T3 DSS modules supported. (36 buttons each, up to 1080 buttons). T3 DSS buttons are not included in the overall system limit for additional button module buttons.
- XM24: (6416+, 6424+)  
Up to 10 XM24 units per system (maximum of 2 per DS expansion module, including the IP406v2) with a maximum of 1 per 6416+/6424+ phone (24 buttons each giving a maximum of 240 XM24 buttons).
- T24 KIM (Key Indicator Module) (T7316)  
Up to 42 T24 KIMs per system (24 buttons each, up to 1008 buttons).

The maximum number of additional button module buttons per system is 1024 (regardless of if the buttons are configured for use or not). Only exception is use of T3 DSS only where, if no other button modules are used, a total of 1080 buttons is supported:

- 12 x BM32 + 5 x EU24 + 20 x SBM24 is allowed (984 buttons in total).
- 15 x T3DSS + 15 x BM32 is allowed (1020 buttons in total).
- but NOT 8 x BM32 + 10 x EU24 (because it exceeds the maximum number of 8 EU24s, even though total buttons < 1024).
- and NOT 14 x BM32 + 5 x EU24 + 20 x SBM24 (total 1048 buttons, this exceeds the maximum 1024 buttons per system).

---

## Analog Telephones

---

As well as providing a lower cost alternative to system specific telephones, analog telephones can still deliver a high degree of functionality on IP Office. They are particularly appropriate in applications where users require lower entry costs and can be used with Phone Manager for a high proportion of call control.

Analog telephones that are compatible with caller display functionality can display the telephone number of the calling party if available. Simple programming of IP Office can convert that numeric display in to the company name associated with that number.

Feature activation by analog telephones is via short codes. IP Office is pre-programmed with a default set of short codes but these can be changed to mimic a legacy telephone system as required.

Avaya would like to stress that although most analog telephones will work on IP Office - Avaya cannot guarantee that all analog telephones in every region of the world will work on the IP Office.

- Analog telephones connect to IP Office via ports marked PHONE ports.



## Avaya 6200 Analog Telephone (North America)

The 6200 range of telephones are single-line analog telephones that require one tip and ring pair for operation. This series of telephones have a Ringer volume control on the side of the telephone and a Handset volume control on the front of the phone. They use DTMF dialing only and support the Positive Disconnect function. In addition, these telephones have a Message light, a recall button that allows access to system features, a redial button that allows automatic redial, a hold button with a single associated light, and a data jack on the rear of the telephone. The 6219 phone adds 10 programmable dialing buttons and the 6221 phone adds a built-in speakerphone with mute capability.



Analog Telephone Features	6211	6219	6221
Programmable buttons (10 buttons)	✗	✓	✓
Program Keylock	✗	✓	✓
Pause	✗	✓	✓
Redial	✓	✓	✓
Speaker	✗	✗	✓
Flash	✓	✓	✓
Hold (with indicator light)	✓	✓	✓
System Hold	✗	✓	✓
Mute	✗	✗	✓
Handset Volume Control	✓	✓	✓
Ringing Volume Control (3 position)	✓	✓	✓
Ringing Patterns (2)	✓	✗	✗
Personalized Ringing	✗	✓	✓
Message Waiting Light	✓	✓	✓
Desk/Wall Mount	✓	✓	✓
Data Jack	✓	✓	✓
Colors	White/Grey	White/Grey	White/Grey
Ringer Equivalency	0.7A, 1.6B	0.5A, 1.5B	0.5A, 1.5B
Hearing Aid Compatible	✓	✓	✓
Positive Disconnect	✓	✓	✓
DTMF Dialing	✓	✓	✓
Specialty Handset Support	✓	✓	✓

---

## Interquartz Gemini Phones (EMEA and APAC)

Avaya have tested the new generation Interquartz Gemini analog telephones with IP Office to ensure that telephone and system are compatible. The Gemini telephones offer good value for money without compromising on quality. Their stylish design and rugged build quality make them a popular choice for buyers on a limited budget.

For sales enquiries and product information contact Interquartz at [avaya-enquiries@interquartz.co.uk](mailto:avaya-enquiries@interquartz.co.uk).

### Basic telephone 9330-AV



- Visual Message Waiting Indication.
- Locking mute button with LED indicator.
- Last number redial.
- Recall button.
- Ringer volume adjust.
- Ringer indicator light.
- Wall mountable - no additional bracket required.
- Hearing aid compatible.
- Rubber feet to minimize slippage

## CLI Feature phone 9335-AV



All features of 9330-AV plus:

- Caller ID with 80 memories (shows date, time and new/repeat/answered/unanswered calls).
- Large 3 line LCD display.
- IP Office feature activation through programmable keys.
- 100 name and number personal directory.
- 20 lockable direct access memories.
- Full handsfree working.
- Headset port.
- Switchable Time Break Recall 100 / 200 / 300 / 600 ms.
- Call timer.
- Alphanumeric keypad.
- Last number redial with 5 memories.

## Hotel Phone 9281-AV



- Removable inlay card for personalized logo printing.
- Triple standard message waiting light (high voltage, reverse polarity and voltage drop).
- 10 non-volatile memories.
- Ringer indicator light.
- Ringer volume and pitch adjustment.
- Last number redial and Recall button.
- Hearing aid compatible.
- Wall mountable – no additional bracket required.
- ELR/TBR switchable.
- MF Only.

## Doorphone Entry Systems for IP Office

Doorphones offer convenience and security. Depending on the needs of the environment, door telephones may allow internal users to not only speak with someone who is outside, but also to easily allow the visitor entrance to the facility or residence. Doorphones can be connected to the Avaya IP Office base unit in a variety of ways, providing design flexibility based upon needs.

All of the IP Office base units include an external output port. Connections of doorphones to these ports enable the user to gain access to the premises through default system short codes, through the optional Phone Manager Pro application, and through the optional Voicemail Pro application. The flexibility of the IP Office provides the ability for short codes to be customized to a code more desirable for users. By using the Phone Manager Pro application, users can label the icons within the application a descriptive name such as Receiving Door or Front Door. The flexibility of Voicemail Pro allows the visitor to enter a predetermined code from the phone granting access. This scenario is particularly useful in areas when co-workers are working at another site. Additionally, many doorphones can be connected to station or trunk ports available on IP Office.

The Avaya IP Office system offers three doorphone solutions to choose from:

- Avaya Universal Doorphone System (North America)
- Kalika Communications Doorphone Entry System (EMEA) - DevConnect Partner
- Interquartz Doorphone (EMEA) - DevConnect Partner
- Algo 3226S Trunk Port FXO Doorphone (NA & EMEA) - Dev Connect Partner (the Algo 3226S has the same industrial design as the Norstar / BCM Digital Doorphone, but leverages Analog Trunk ports instead of Digital Station Ports)

### Avaya Universal Doorphone System:

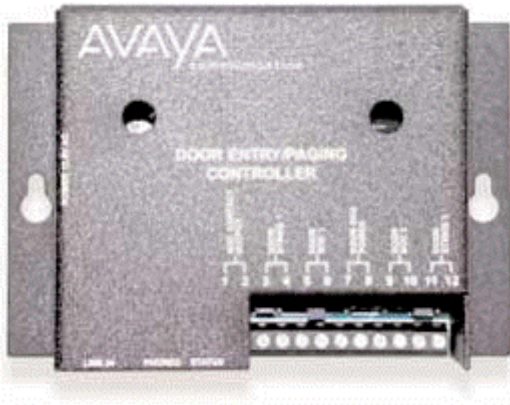

- System consists of a controller and a speaker.
- The speaker is mounted securely on the wall and is connected to the controller, which normally resides in the equipment room. The controller is connected to a trunk port.
- Users with the trunk appearance will be notified when a visitor has pressed the Push button located on the weatherproof speaker.
- Each controller supports two speakers, for example Front Door and Back Door.
- Custom ringing mode distinguishes doorphone calls from external calls.
- Call waiting tones indicate which doorphone is calling and distinguish a doorphone call from an external line call.
- Calls can be placed on hold when visitors call from the doorphone.
- Commercial or residential security is provided via two-way handsfree communication from a door or gate.

---

## Headsets

---

Avaya offers ergonomically designed communication headsets and amplifiers for the Avaya IP Office telephones. This full line of professional and contact center solutions set the standard in sound quality and durability. Avaya headsets are designed for maximum, all-day comfort and are available in styles that suit nearly any wearer and any usage pattern.

Whether you want the freedom to communicate handsfree while working at your desk, or the ability to roam while talking, you will find a solution that suits your individual needs.



Please check [www.avaya.com](http://www.avaya.com) for a current list of supported headsets.

## Summary

All Avaya telephones are designed to ensure that features and functions are easily accessible to the user - ensuring that, through ease of use, the full benefits of the system are delivered to the desktop.

The telephones that support handsfree operation are intended for individual use only, not for group and conference room operation.

The telephones listed below are the preferred and premier range of telephones for use on the IP Office. These telephones are sold worldwide in every country that the IP Office is available. This telephone range consists of both digital and IP telephones.

<b>IP Office worldwide digital telephones:</b>	<b>IP Office worldwide IP telephones:</b>
• 1403 Telephone	• 1603 IP Telephone
• 1408 Telephone	• 1608 IP Telephone
• 1416 Telephone	• 1616 IP Telephone
• 9504 Telephone	• 9608 IP Telephone
• 9508 Telephone	• 9611 IP telephone
	• 9621 IP Telephone
	• 9641 IP Telephone

In addition to the telephones above, the IP Office supports a wide range of telephones as listed below. However, note that some of these telephones are only available in certain countries and regions.

<b>Other digital/analog telephones:</b>	<b>Other IP telephones:</b>
• 2402 Telephone	• 9620L/9620C IP Telephone
• 2410 Telephone	• 9630G/9640/9640G IP Telephone
• 2420 Telephone	• 9650/9650C IP Telephone
• 3810 Wireless Telephone	• 3720 DECT R4 Wireless Handset
• EU24/EU24BL DSS Unit	• 3725 DECT R4 Wireless Handset
	• 3740 DECT R4 Wireless Handset
	• 3749 DECT R4 Wireless Handset
	• 36451 Wireless (WiFi) Phone
	• 3645 Ruggedized Wireless (WiFi) Phone

The following Norstar/BCM telephones are fully supported on IP Office R8 but might require special interface cards/modules. Not all of them are available for new sales and they are not available to all channels.

<b>Norstar/BCM Heritage Digital telephones</b>	<b>Norstar/BCM Heritage IP telephones:</b>
• T7000	• 1120 IP phone
• T7100	• 1140 IP phone
• T7208	• LCD KEM for 1100 telephones
• T7316; T7316e	• 1220 IP phone
• T24 KIM- Key Indicator Module	• 1230 IP phone
• M7000	• LCD KEM for 1200 telephones
• M7100	• LED KEM for 1200 telephones
• M7208	7420/7430/7440 Digital Mobility Handsets (2.4 GHZ)
• M7310	• 7439/7449 Digital Mobility Handset, DECT, North America
• M7324	• 4135/4145/4145EX Digital Mobility Handset, DECT; EMEA and Hong Kong
• CAP (48 buttons) - Central Answering Position	• 4136/4146/4146EX Digital Mobility Handset, DECT; Australia and NZ.
• T7406, T7406E BXT cordless Telephone, North America	• 7420/7430/7440 Digital Mobility Handsets, DECT, South America

Only the Global version of the M7000 Series will be supported on the IP Office. The Non-Global version (also called NA version) of the M7000 Series set is not supported on the IP Office. The Non-Global versions were available from the late 1980s to the early 1990s and only sold in North America. The Global version was available in all regions including NA as of the Early-Mid 1990s until the End of Sale of the M7000 Series sets.

The Global and Non-Global sets can best be identified through their contrast level:

- Global version – 9 Contrast Levels
- Non-Global version – 4 Contrast Levels

Avaya partners should notify the end-customers that the M7000 has reached the End of Life status and hence technical support for them is limited.

**Note:** All versions of the T7000 Series are supported and there are no minimum firmware or regional requirements for the BST T7000 Series sets.

The following Norstar/BCM Digital mobility components are supported on IP Office R7 but might require special interface cards/modules. Not all of them are available for new sales and they are not available to all channels

<b>Digital Mobility 2.4 GHz solution - North America and CALA</b>	
Digital Mobility Base Station 10	(2.4GHz, Compatible with Handset 7430/7440, Repeater 40)
Digital Mobility Repeater 40	(2.4GHz, Compatible with Handset 7430/7440, Base station 10)
Digital Mobility External Antenna 51	
DMC 080	Digital Mobility Controller - N.A.
DMC 320	Digital Mobility Controller - N.A.
<b>Digital Mobility 1.9 GHz solution - North America (1929-1930 MHz)</b>	
Digital Mobility Base Station 19 (NAR)	
Digital Mobility Repeater 49 (Canada, US)	
Digital Mobility External Antenna 51	
DMC 080	Digital Mobility Controller - N.A.
DMC 320	Digital Mobility Controller - N.A.
<b>Digital Mobility 1.8 GHz solution - Europe, Hong Kong, Australia, New Zealand (1880-1900MHz)</b>	
Digital Mobility Base Station 15	
Digital Mobility Repeater 25	
Digital Mobility Repeater 45	
Digital Mobility External Antenna 51	
DMC 081	Digital Mobility Controller - International
DMC 321	Digital Mobility Controller - International
<b>Digital Mobility 1.8 GHz solution - South America (1900-1930 MHz)</b>	
Digital Mobility Base Station 14	
Digital Mobility Repeater 24	
Digital Mobility External Antenna 51	
DMC 081	Digital Mobility Controller - International
DMC 321	Digital Mobility Controller - International

The following telephones are fully supported on IP Office R6 but are no longer available for new sales.

<b>Other digital/analog telephones:</b>	<b>Other IP telephones:</b>
• 4406	• 5601 IP Telephone
• 4412	• 4601 IP Telephone
• 4424	• 4602SW IP Telephone
• 4450 DSS Unit	• 5602SW IP Telephone
• 4610SW IP Telephone	• 4610SW IP Telephone
• 5610SW IP Telephone	• 5620 IP Telephone



• 5402 Telephone	• 4620/21 IP Telephone
• 5410 Telephone	• 4625SW IP Telephone
• 5420 Telephone	• 3616 Executive Wireless (WiFi) Phone
• T3 Comfort (Up)	• 5621 IP Telephone
• T3 Classic (UPN)	• 3620 Healthcare Wireless (WiFi) Phone
• T3 Compact (UPN)	
• T3 DSS Module	

- For maximum cabling distances please refer to the IP Office Installation Manual.

### **Legacy Telephone Support**

The following telephones are not supported by IP Office Release 6. They may function but have not been tested with IP Office Release 7.0 and any faults reported with IP Office Release 7.0 will not be fixed.

- 20DT Analog DECT used with IP Office Analog DECT and Compact DECT.
- TransTalk 9040

# **Chapter 7.**

# **Features and Call Handling**

## 7. Features and Call Handling

IP Office provides a comprehensive telephony feature set to enable a fast and efficient response to a telephone call. Features such as Caller ID display and call tagging allow employees to see who is calling and who they are calling before they pick the call up. Client information can even be 'popped-up' on the user's PC.

For those who are not tied to a desk, Wireless handsets and twinning offer mobility around the office. For those out of the office, be it on the road or working from home, comprehensive and easy to use call forwarding facilities, PC Softphone and a remote access service allow them to remain in telephone contact and access centralized resources at all times.

Incoming calls can be efficiently handled using either Direct Dialling (DDI/DID) or dedicated operators. For out of hours calls or times when you just can't take calls, IP Office provides voicemail and optional Auto-Attendant services.

---

## Basic Call Handling

---

### Tones

IP Office generates the correct user tones for the geography. These tones are generated for all IP Office extension types, analog, digital and IP.

Supported tones are:

- Normal, alternate, and secondary; depending on geography
- Busy
- Unobtainable
- Re-order
- Conferencing tone depending on geography

---

### Caller ID

#### Feature

- Display of the caller's number on incoming calls, where supplied by the service provider.
- Sending of calling number on outgoing external calls.

#### Benefit

- Confirmation and recognition of who is calling.
- Storage of Caller ID numbers for return calls.
- Directory name matching to Caller ID numbers.
- Screen-Popping customer records in compatible applications.

#### Description

Where supplied by the service provider, the IP Office can receive and use the caller's Caller ID. The Caller ID is passed through to the answering phone or application and is included in any call log or history supported by the phone or application. If the Caller ID matches a number in the IP Office's Directory, the matching directory name is shown instead of the number.

Where IP Office Phone Manager, or the TAPI service is used to link to database software on the user's PC, it is possible to have an automatic query performed on the supplied Caller ID and have the caller's record in front of the user before the call is answered.

For outgoing calls the IP Office can insert a system wide Caller ID or set a flag to have Caller ID withheld. For users with a direct dial number routed to their extension, that direct dial number is also used as their Caller ID for outgoing calls. Alternatively short codes can be used to specify the Caller ID that should be sent with outgoing calls.

Note that the sending and receiving of Caller ID is subject to the service provider supporting that service. The service provider may also restrict which numbers can be used for outgoing Caller ID.

---

### Call Screening

#### Feature

- The user has the capability to screen incoming calls while the phone is in an idle state, and the user can listen to incoming calls transferred to voicemail.

#### Benefit

- Screen for important calls and decide if you should answer the call or let it go to voice mail

#### Description

When an incoming call arrives at your phone and is then directed to and answered by the voice mail system, you automatically hear the caller on your phone speaker, but the caller cannot hear you. You can decide whether to answer the call or drop from the call and let the voice mail system continue to handle the call.

**Note:** You cannot screen a call whilst you are on another call.

---

## Hold

A call may be placed on hold with optional Hold music. A held call cannot be forgotten as it is presented back to the extension after a timeout set by the system's administrator.

See also [Park](#) <sup>[229]</sup>.

---

## Toggle Calls

Toggle Calls cycles round each call that the user has On Hold to their extension locally within the system, presenting them one at a time to the user.

---

## Hold Call Waiting

Hold Call Waiting is a compound feature combining hold and answer and provides a convenient way to hold an existing call and answer a waiting call through a single button press.

---

## Hold Music (Music on Hold)

The IP Office system supports up to 4 sources of music on hold – system sources which may be external: one system source plus 3 additional external sources using analog extensions. Internal (WAV) or tone plus up to 3 additional internal sources. The internal sources are .WAV files saved either in volatile memory, or on the optional memory card in an IP500 and IP406 V2. The .WAV file must be 16bit PCM mono and sampled at 8Khz with a maximum duration of 30 seconds.

Alternate sources for music on hold are selectable for use by Incoming Call Routes or Hunt Groups. On IP500, and IP500 V2 systems, each source can be up to 90 seconds long.

External music on hold sources connect to the 3.5mm Audio socket on all IP Office control units, or configured analog extensions.

---

## Park

As an alternative to placing a call on hold, a call can be parked on the system to be picked by another user.

The call park facility is available through the user's telephone, Avaya one-X™ Portal for IP Office, Phone Manager or SoftConsole. Calls are Parked against a 'park slot number' which can be announced over a paging system so the person the call is for can go to any phone and collect the call by dialing the park slot number.

For convenience Phone Manager has 4 pre-defined park buttons. On digital telephones with DSS/BLF keys it is possible to program Park keys that will indicate when there is a call in a particular park slot and allow calls to be parked or retrieved.

There is a system configurable timeout that determines how long a call may remain parked before it is re-presented to the extension that originally parked the call.

---

## Automatic Callback

### Feature

- When calling an extension that is busy, set the system to call you when the extension becomes free. This feature is also called "Ringback When Free".
- When calling an extension that just rings, set the system to call you when the extension is next used. This feature is also called "Ringback When Next Used".

### Benefit

- Carry on with other work and let the system initiate a call for you when the extension becomes available.

### Description

Depending on the type of phone a user has, call back when free is accessed by dialing a short code if an internal busy tone is heard, selecting an option from an interactive menu or pressing a programmed DSS/BLF key. Callback when free can also be activated from Phone Manager.

You can also set a callback when free or a callback when next used using a short code without attempting a call.

This feature is supported across the [IP Office Multi-Site/Small Community Network](#) <sup>[286]</sup>.

---

## Direct Inward Dialing (DID/DDI)

This relies on the local telephone exchange passing all or part of the dialed number to the IP Office. This number can then be used by IP Office call routing software to route the call to an individual phone, or groups of telephones. This service is typically used to reduce the workload on a reception position by giving members of staff or departments individual numbers so they can be called directly. For convenience it is common to have the extension or group number the same as the digits supplied from the network, but IP Office can convert the number to a number as needed by the business, within limits

In North America, T1 circuits are required for DID.

---

## Transfer

Call Transfer allows users to transfer a call in progress to another phone number – either internal extension or external public number. The caller is placed on hold while the transfer is performed.

If the phone is put down before the destination has answered, the original caller will be automatically transferred. This is called an Unsupervised or Blind Transfer. Alternatively, a user can wait for the destination to be answered and announce the transfer before hanging up to complete the transfer. This is called a Supervised Transfer.

Unless restricted by the system administrator, the IP Office makes no differentiation between internal or external call transfers.

---

## Distinctive and Personalized Ringing

The IP Office uses different ringing sequences to indicate the type of call, for example whether internal or external. This feature is called 'distinctive ringing'. For analog telephones the distinctive ringing sequences used are adjustable. For digital and IP telephones the distinctive ringing sequences are fixed as follows:

- Internal Call: Repeated single-ring.
- External Call: Repeated double-ring.
- Ringback Call: Single ring followed by two short rings.

This ring is used for calls returning from park, hold or transfer. It is also used for call back when free and voicemail ringback calls.

This feature is supported across the [IP Office Multi-Site/Small Community Network](#) <sup>(286)</sup>.

---

## Personalized Ringing

In IP Office the term personalized ringing is used to refer to changing the sound or tone of a phone's ring. On many Avaya digital telephones, the ringer sound can be personalized. Changing the ringer sound does not alter the ring sequence used for distinctive ringing. This feature is local to the telephone and not supported on all types of telephones.

---

## Message Waiting Indication

Message waiting indication (MWI) is a method IP Office uses to set a lamp or other indication on compatible telephones when a new message has been left for the user, either in a personal voice mailbox or in a group mailbox or call back message. When the message has been played or acknowledged, the lamp is turned off.

All Avaya digital and IP telephones have in-built message waiting lamps. Avaya one-X™ Portal for IP Office provides message waiting indication on screen.

For analog telephones, from IP Office 3.1 a variety of analog message waiting indication (MWI) methods are provided. Those methods are 51V Stepped, 81V, 101V and Line Reversal. The MWI method must be selected from the IP Office Manager when configuring a system to match the properties of the analog telephones. Note that the 101V signaling is only available on IP500 Phone cards and expansion modules plus version 2 IP400 Phone 8, 16 and 30 expansion modules.

---

## Visual Voice

### Feature

- Provides interface to voicemail through display and buttons e.g. Listen, Save, Delete, Fast Forward.

### Benefit

- Quick access to voicemails and commonly used messaging features.

### Description

You can access and control voice messages via the display on Digital or IP telephones. Visual Voice requires Preferred Edition or Essential Edition, and can only be used with large display LCD sets only from the 1400, 1600, 2400, 5400, 4600, 5600, 9500, 9600 and T3 Series. (1403, 1603, 1603SW, 2402, 5402, 4601, 4602SW, 5601, 5602SW do not support Visual Voice). On telephones that have a display but do not support visual voice operation, use of the button for user mailbox access using voice prompts and for direct to voicemail transfer during a call is supported (does not include T3 and T3 IP telephones).

Features supported are:

- access new/old/saved messages for personal and hunt group mailboxes.
- next and previous message.
- fast forward and rewind.
- pause message.
- save, delete and copy message to other users of the system.
- change default greeting.
- change password.
- change email settings (Preferred Edition only).

---

## Advanced Call Handling

---

### Description

In larger businesses or businesses with greater reliance on the telephone for internal and external communications some of the more advanced features will improve efficiency and customer service. Features like Pick-Up which permit users to take a call for a colleague who is temporarily away from their desk, or Absence Text which can quickly give information to internal callers about a person's availability.

---

## Absence Text

### Feature

- Display a text message on the user's phone and IP Office Phone Manager application.
- Display the same message on other internal telephones and IP Office applications when calling the user.

### Benefit

- Inform other internal users of your current status and likely availability.

### Description

Any user can set Absence Text on their phone, even users of standard analog telephones, but it can only be displayed on selected display telephones, Phone Manager and SoftConsole that call the user. Most supported feature telephones give the option of adding some text, for example, "At lunch until 16:00".

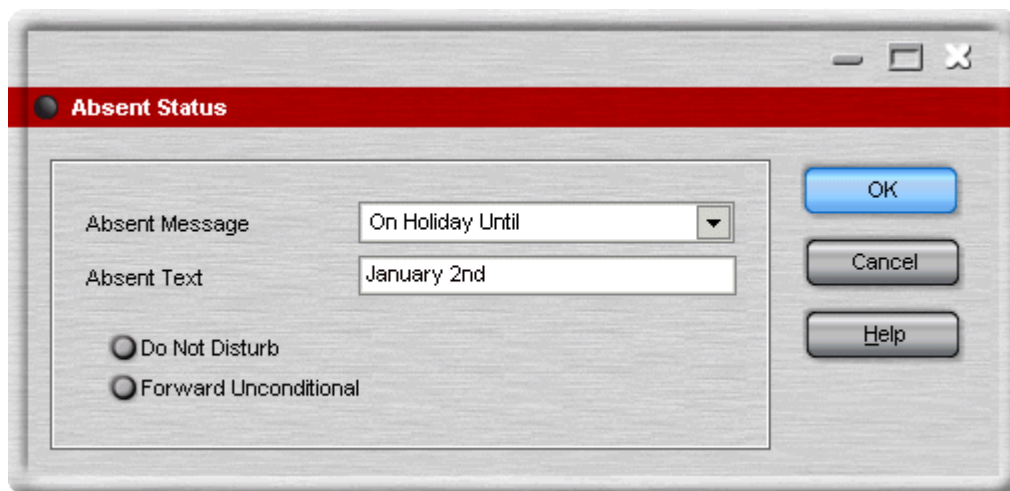

When a user has an absence text message set, call processing is not affected to the user and they still have the choice of using features like Do Not Disturb or Forward on No Answer as appropriate. Telephones that support the interactive setting of Absence Text will also display it on the users own phone for the benefit of people who come to their desk. There are 10 predefined strings for Absence Text:

- None (no text message)
- "On vacation until"
- "Will be back"
- "At lunch until"
- "Meeting until"
- "Please call"
- "Don't disturb until"
- "With visitors until"
- "With cust. til"
- "Back soon"
- "Back tomorrow"
- Custom

All may have additional text entered, eg message 4 plus 10:00 will show "Meeting until 10:00" and the text strings are localized to the system language

This feature is supported across the IP Office Small Community Network (SCN).

---

## Call Tagging

### Feature

- Display a text message on the user's phone, Avaya one-X™ Portal for IP Office or Phone Manager, when a call is presented to it.

### Benefit



- Provide additional information about the call.

**Description**

This feature is used to provide additional information about the call to the targeted user before they answer it. Call Tagging may be used when transferring a call from Avaya one-X™ Portal for IP Office, Phone Manager or Soft Console to give caller info if the user doing the transfer is not able to announce the call.

It is possible to add a tag to a call automatically using CTI and IP Office Voicemail Pro. This is also possible based on an Incoming Call Route. On some telephones, displaying the Tag may mean that it is not possible to display the usual call source and target information.

---

## Reclaim Call

**Feature**

- The ability to recover, or reclaim, the last call that was at your phone but is now ringing or is connected elsewhere.

**Benefit**

- If you just miss a call and it goes to voicemail or call coverage, you can get the call back while it is still being presented or connected through IP Office

**Description**

This is a special version of the Acquire Call feature that only applies to the last call at your extension.

---

## Hunt Group Enable/Disable

**Feature**

- The ability for a user to enable or suspend their membership of hunt groups.

**Benefit**

- A user may need to temporarily join or leave individual hunt groups, for example to cover a peak of calls without changing the system programming.

**Description**

A team supervisor or administrator may not usually take calls for a team but at times of high traffic they may join the group to take calls and when the peak is over leave the group to resume their regular tasks. To use this feature the User must be configured as a member of the hunt group by the systems administrator, it is not possible for a user to arbitrarily join a hunt group that they have not been identified as a member of.

---

## Call Waiting

A User may not want people calling them to receive busy tone if they are already on another call, but have the call receive ring tone and have some kind of alert that there is a call waiting. The user can then decide to finish or hold the current call and answer the one that is waiting. The amount of information that is available about the call that is waiting depends on the type of phone the user has, or if they are using Avaya one-X™ Portal for IP Office or Phone Manager.

As Call waiting tone can be disruptive it is possible to turn the feature on or off and even suspend it for a single call – useful for conference calls.

---

## Do Not Disturb (DND)

This is the ability to temporarily stop incoming calls ringing at a user's telephone. It will prevent the user from receiving hunt group calls and give direct callers either voicemail (if enabled) or a busy signal. This feature can be enabled/disabled from the phone or via Avaya one-X™ Portal for IP Office or Phone Manager.

It is possible to have some calls bypass the DND setting and ring the phone. For example a manager might have their secretary's extension number on the DND exceptions list. The exceptions list can be easily managed by the Avaya one-X™ Portal for IP Office or Phone Manager. Both internal and external numbers can be on the exception list.

---

## Dial Plan

IP Office has a very flexible numbering scheme for extensions, hunt groups and feature commands. While the system has default numbering for feature codes and extensions, they can all be re-defined. Default extensions and hunt groups have 3 digit numbers starting at 200 but these can be changed from 2 to 9 digits through the

IP Office Manager. There is a default set of feature access "short codes," but these can be changed to whatever the end user requires, within limits. This is useful for example, if IP Office is replacing a system where DND was accessed by dialing \*21, it is possible to change the IP Office Short Code to mimic the code of the replaced system.

In certain countries IP Office can support a Secondary Dial Tone when an access digit is dialed, though this limits some functionality like Alternate Route Selection (ARS). IP Office can also be configured to work without line access digits, by analyzing digits as they are dialed and determining if they are for an internal number or should be sent out on a line – this is valuable in SOHO installations where users will not necessarily be used to dialing an access digit for an outside line.

---

## Paging

All Avaya digital and IP telephones supported on the IP Office that have loudspeakers can be used to receive broadcast audio messages without having to install a separate paging system. Paging can be to individual telephones or groups of telephones.

Analog extension ports can be configured for connection to external overhead paging systems, usually through an adapter, such that a port can be included in a paging group to permit mixed phone and overhead paging.

Some Avaya digital and IP telephones are able to answer a page by pressing a key while the page is going on, this terminates the page and turns it into a normal call.

This feature is supported across the IP Office Small Community Network

---

## Intrude

The Call Intrude feature allows a user, if permission through IP Office Manager is given, to join an existing conversation whether this is an internal or external call.

A user with the "Can Intrude" option can join a call on any extension on the system, however, a User with "Cannot be Intruded" setting would prevent others from joining their call.

---

## Inclusion

This feature enables selected users to intrude on calls that are already in progress. The intruding party intrudes on the existing call and all parties hear a tone. The speech path is enabled between the intruding party and the called user; the other party is forced onto hold and will not hear the conversation. On completion of the intrusion the called party speech path is reconnected to the original connected party. The feature is enabled or disabled on a per user basis through the Manager.

---

## Private Call

Users can set a status of private call using short codes or a programmed button. Private calls cannot be recorded, intruded on, bridged into or monitored.

---

## Hot Desking

Hot Desking allows a number of users non-exclusive use the same extension. Each user logs in with their own identity so they can receive calls and can access their own Voicemail and other facilities. For example, sales personnel who visit the office infrequently can be provided with telephony and Voicemail services without being permanently assigned a physical extension. When finished, they simply log out to make the extension available to others or if users log in at another phone, they are automatically logged out of the original extension.

---

## Remote Hot Desking

### Feature

- The ability for a user to Hot Desk to other locations within the Small Community Network.
- Available on Digital, Analog and IP telephones.

### Benefit

- A user can make and receive calls from any office as if using the phone on their own desk.
- Single number, improved mobility and easy access to familiar features.

- The user has access to the centralized system and personal directory as well as their call log (1400, 1600, 9600 Series and T3 telephones only).
- Great for consultants, managers, lawyers working on different offices on different days.

### Description

IP Office supports remote hot desking between IP Office systems within a Small Community Network (SCN). The system on which the user configured is termed their 'home' IP Office, all other systems are 'remote' IP Offices. No additional licenses are required to support Remote Hot Desking other than the Voice Networking license on each IP500 within the SCN.

- **User Settings**  
When a user logs in to a remote IP Office system, all their user settings are transferred to that system.
  - The user's incoming calls are rerouted across the SCN.
  - The user's outgoing calls use the settings of the remote IP Office.
  - However some settings may become unusable or may operate differently. For example if the user uses a time profile for some features, those feature will only work if a time profile of the same name also exists on the remote IP Office.
- **Break Out Dialing**  
In some scenarios a hot desking user logged in at a remote system will want to dial a number using the system short codes of another system. This can be done using either short codes with the Break Out feature or a programmable button set to Break Out. This feature can be used by any user within the Small Community Network but is of significant use to remote hot deskers.

**Note:** Remote Hot Desking is not supported for use with Customer Contact Center (CCC) or Customer Call Reporter (CCR). Features handled by the telephone itself are not affected by Hot Desking (e.g. call log and phone speed dials).

---

## Relay On/Off/Pulse

IP Office is fitted with two independent switch outputs for controlling external equipment such as door entry systems. Control of these switches is via allotted handsets allowing the switches to be opened, closed or pulsed as required. Control of switches is also accessible via, Receptionist SoftConsole and Voicemail Pro.

---

## Pickup

Call Pickup allows a user to answer a call presented to another extension. Types of call pickup include:

- Pick up any call ringing on another extension.
- Pick up a hunt group call ringing on another extension, where the user must be a member of that hunt group.
- Pick up a ringing call at a specified extension.
- Pick up any call ringing on another extension that is a member of the hunt group specified.

This feature is supported across the IP Office Multi-Site Network (SCN).

---

## Call Recording

Where IP Office has Voicemail Pro installed it is possible to record a call and save the recording to the user's mailbox, a group mailbox or the voice recording library. For example, this is useful when a caller is going to give detailed information like an address or phone number and the caller will hear a warning message or tone that the call is being recorded in some countries. Where call recording is required for Quality Assurance, it is possible to set the IP Office system to automatically record a percentage of calls for later review.

Beginning with IP Office R4.0, any call (normal, conference, or intrusion) and any phone type (including IP) can be recorded. Where "advice of recording" needs to be played, IP Office will ignore Voicemail port licensing if an insufficient number of voicemail channels have been licensed.

**Note:** for IP telephones, a VCM channel will be required for the duration of the recording.

---

## Telecommuter Mode

Avaya one-X™ Portal for IP Office allows the making and receiving of calls and the retrieving of voicemails from an external phone number as if they were in the office, with the Avaya one-X™ Portal for IP Office server providing the call control. The typical scenario is the remote worker that occasionally works from home or from a hotel room.

This feature also provides billing convenience and potential cost savings for remote workers and mobile work force as all the calls are established by IP Office: there is no need to check bills, nor to pay for expensive hotel calls.

---

## Twining and Mobility

Twining allows a primary extension and a secondary number (extension or external) to operate together as a single telephone. When a call is presented to the primary phone the secondary will ring. If the primary telephone does not ring, for example in Do Not Disturb, the secondary phone will not ring.

Please refer to the [Mobility Chapter](#)<sup>[382]</sup> for more details.

### Internal Twining

This is typically used in scenarios like workshops or warehouses where team supervisors may have a desk with a fixed phone but also have a wireless extension (e.g. DECT). When a call is made from either twinned phone, the call will appear to have come from the primary phone. Other users of the system need not know that the supervisor has two different telephones. The supervisor's Coverage Timer and No Answer Time are started for the call and if the call is not answered within that time, the call will be delivered to available coverage buttons (if applicable) and then Voicemail (if applicable).

The following features are supported with internal twining:

- Follow Me To
- Follow Me Here
- Forwarding
- Do Not Disturb (inc exceptions)
- Context less hunt group actions: Membership / Service Status / Fallback Group configuration
- Voicemail On / Off / Access
- Call Log (Central Call Log for T3 and 1600 telephones only)
- Redial (Central Call Log for T3 and 1600 telephones only)
- Personal Directory Entries (for T3 and 1600 telephones only)

Mobility Features include:

- Mobile (external) Twinning
- Mobile Call Control
- Mobility Callback
- Avaya one-X Mobile Client Support

---

## Key and Lamp Operation

---

IP Office offers a full range of Key and Lamp features on Avaya feature telephones. These features include; Line Appearance, Call Appearance, Bridged Appearance and Call Coverage. As these features require a phone with buttons and indicators, the features are only supported on certain Avaya digital and IP telephones. Key and Lamp operation is not supported on analog telephones.

IP Office can have a ring delay set on each appearance button to allow time for the target number to answer before other extensions ring, or visual alert only without ring.

In Key and Lamp operation, IP Office supports up to 10 buttons on each telephone and 10 telephones with the same line appearance.

---

## Appearance Buttons

### Feature

- Use the programmable buttons available on Avaya digital and IP telephones to represent individual calls.
- Answer, originate and join calls by pressing the appropriate appearance buttons.

### Benefits

- Indication of calls connected and calls waiting.
- Handling of multiple calls from a single phone.

### Description

Many Avaya digital and IP telephones supported by IP Office have programmable buttons. These buttons can be assigned to appearance functions that allow the handling of calls. These functions are:

- Line Appearance Buttons  
Used to indicate make and answer calls on a specific external trunk.
- Call Appearance Buttons  
Used to handle multiple incoming and outgoing calls from a user's extension.
- Bridged Appearance Buttons  
Used to match the call appearance buttons on a colleagues extension.
- Call Coverage Buttons  
Used to indicate unanswered calls ringing at a colleagues extension.

---

## Line Appearance

A Line Appearance is a representation of a trunk line on the IP Office system where the indicator tracks the activity on the Line. Only external calls can be answered or made on Line Appearances. Line appearances can be used with Analog, E1 PRI, T1 PRI and BRI trunks PSTN trunks. They cannot be used with E1R2, QSIG and IP trunks.

---

## Call Appearance Buttons

### Feature

- Uses a programmable button on the Avaya digital and IP telephone to represent an incoming or outgoing call.
- Separate buttons are used to represent each simultaneous call that the user can make or answer.
- Where possible, the status of the calls (ringing, connected or held) is indicated by the button indicator.

### Benefit

- Call appearances allow a single user to make, answer and switch between multiple calls by pressing the appropriate call appearance button for each call.

### Description

On Avaya IP Office digital and IP telephones that have programmable buttons, those buttons can be set as call appearance buttons through the IP Office Manager. The number of call appearance buttons set for a user determines the number of simultaneous calls they can make and answer.

Note that the use of call appearance buttons overrides IP Office call waiting features. It is only when all call appearances are in use that subsequent callers receive either busy tone, voicemail or follow a forward on busy action

When call appearance buttons are used, a minimum of three call appearance buttons is recommended where possible, although some telephones are restricted to two call appearance buttons by the number or design of their programmable buttons.

---

## Alerting/Ring Tone for Covered Calls

### Feature

- The alert signal (ring tone) for incoming calls for covered telephones can be set to the following values: Ring (default), Abbreviated Ring and No Ring.

### Benefits

- The ability for a user to choose how the covered call will alert.
- To keep the alerting noise low in open-plan offices.

---

## Bridged Appearance Buttons

### Feature

- Allow the user to have an appearance button that matches another user's call appearance button.

### Benefit

- Answer and make calls on behalf of the other user.
- Audible indication of calls presented to the bridged user, where programmed
- Visual indication of when the other user has calls presented, held or connected.
- Join and exchange calls using the paired call appearance and bridged appearance buttons.

### Description

A bridged appearance button matches the activity on one of another user's call appearance button. For example, when the call appearance shows a ringing call, the bridged appearance button will also show the ringing call and can be used to answer that call.

Similarly, if the bridged appearance button is used to make a call, the call activity is shown on the matching call appearance button. The call appearance button user can join or takeover the call using their call appearance button.

Bridged appearance buttons allow paired 'manager/secretary' style operation between two users, and are only supported for users who have call appearance buttons.

---

## Call Coverage

### Feature

- Allow unanswered calls to alert at other user extensions and be answered there before being forwarded or going to voicemail.

### Benefit

- Provide users the opportunity to answer colleague's unanswered calls before they go to voicemail.

### Description

When a user has an unanswered call ringing, after a configurable delay, the call will also start alerting on any call coverage buttons associated with the user on other extensions. The call can then be answered by pressing the call coverage button. If still unanswered the call is forward or goes to voicemail as normal.

The time a call rings before also alerting on any associated call coverage buttons can be adjusted for each user.

---

## External Call Lamp Indication

### Feature

- New system wide configuration parameter to select the LED flash pattern for external calls on Bridged and Coverage appearances.

### Benefit

- The user can determine if the covered call is internal or external.

---

# Outbound Call Handling Features

---

Every business needs to make calls, but depending on the type of business these calls may need to be treated in a special way, such as recorded against a project or client through the use of Account Codes. A business may have several sites linked via a private network but certain users, like customer services agents, may need to be able to call colleagues in other offices even when the network is busy, while other users can wait for a line to come free, Least Cost Routes can automatically translate the internal number to a direct dial call over the public network while other users wait.

---

## Account Codes

### Feature

- Associate an account code with a call.
- Validate account codes used against list stored by the IP Office.
- Include the account code used with call log details.

### Benefit

- Through the call records, group calls by account code for the purpose of call costing and tracking.
- Restrict outgoing calls by requiring users to enter a valid account code.

### Description

IP Office stores a list of valid account code numbers. When making a call or during the call, the user can enter the account code they want associated with that call. IP Office will check the account code against its list of valid codes and request the user to re-enter the code if it is not valid. For incoming calls, the Caller ID can be used to match it with an account code from the IP Office's list of valid codes and report the account code with the call for billing.

Individual users can be set to Forced Account Code operation where they are required to enter a valid account code before making external calls. By using IP Office Short Codes it is possible to identify certain numbers or call types as requiring a valid account code before permitting the call to proceed, for example long distance or international numbers. Analog phone users can only enter account codes before making a call or in response to an audible system prompt to enter a code when making the call.

Account codes can also be entered through the Avaya one-X™ Portal for IP Office and Phone Manager. A system wide setting determines whether Phone Manager will display a list of account codes from which the user can select the code required or will hide the account code list.

In all the cases above, the account code entered is included with the call details in the IP Office's call record output. (SMDR).

---

## Authorization Codes

Authorization codes allow an IP Office user to go to another extension on the system and make calls using their personal toll restrictions; this may grant the user greater or fewer privileges than the normal owner of the extension they use. Since Authorization Codes are independent of Account Codes, the user has to enter both if the required by the system configuration. All entered codes are logged in SMDR.

---

## Dial Emergency

Dial emergency is an IP Office Short Code and, permits certain numbers to be dialed regardless of call barring or a phone being logged out.

---

## Call Barring

### Feature

- It is possible to prevent or allow calls to certain numbers such as international numbers or premium rate numbers for individual users or on a system wide basis.

### Benefit

- Restrict the dialing of specific numbers or types of numbers system wide.
- Restrict certain users from dialing specific numbers or types of numbers.

### Description

IP Office supports call barring at many levels. Short codes can be used at the system or individual user level to



block the external routing of specific numbers or types of numbers. Typically the barring short codes are set to return busy tone, however they could route the call to an alternate number or to a Voicemail service that returns a 'barred dialing message'.

For users, the short codes can be allocated to a User Rights template. This template is then applied to the Users whose calls need restriction. In addition to barring the dialing of certain numbers, IP Office can be set to bar the forwarding of calls to external numbers on a per user basis.

---

## Alternate Route Selection (ARS)

IP Office supports Alternate Route Selection (ARS). If a primary trunk is unavailable, then ARS provides automatic fallback to an available trunk (e.g., analog trunk fallback if a T1 or SIP trunk fails, or use PSTN for SCN fallback).

By configuring ARS, calls may be routed via the optimum carrier. Time profiles can also be used to allow customers to take advantage of cheaper rates or better quality at specific times of day.

Multiple carriers are supported. For example, local calls are to go through one carrier between specific hours and international calls through an alternative carrier. Carrier selection using 2-stage call set up via in-band DTMF is possible. It is possible to assign specific routes on a per user basis, e.g. only allow expensive routes to be used by critical staff.

---

## Maximum Call Length

This feature allows the system to control the maximum duration of any call based on the dialed number. This could be used for controlling calls to cellular networks or data calls made over the public network to ISPs.

---

## Transferable Dial Out Privilege

### Feature

- A privileged user (Operator / Supervisor) can transfer an outside line (secondary dial tone) to a user that does not have external privileges.

### Benefits

- Provides the company with control over external calls
- Provides the ability to provide outside line access for restricted telephones . (e.g., those in public areas or conference rooms)

---

## Idle Line Preference

### Feature

- Going off hook will select the first Idle line appearance and the user will be connected to an outside line.

### Benefit

- Provides the ability to select a specific external line (for companies that prefer to work in key-system mode).

---

## Forwarding

---

This is the ability to forward a user's calls to another extension or external number such as a Mobile/Cell Phone. Calls can be forwarded in a number of ways and if the call is not answered at the forward destination it will go to IP Office voicemail if enabled for the user and call supervision is available. Once the numbers have been entered, the user can toggle the forwarding to be active or not as required without having to re-enter the numbers.

If the user is a member of a hunt group, some types of hunt group calls can also follow forward unconditional. Users can select if forwarding is applied to external calls only, or all calls. Call forwarding is processed after Do Not Disturb and Follow-Me conditions are tested.

### Associated Features

- Do Not Disturb (DND)
- Voicemail
- Follow Me
- Hunt groups
- No Answer Interval

### Precedence

- Forward Unconditional
- Forward Busy
- Forward No Answer

---

## Coverage to Operator

### Feature

- An operator or a group of operators can be configured to provide coverage for external calls that would otherwise go to voicemail.

### Benefit

- Any unanswered calls will be routed to an operator or a Group of operators. For example, local government offices prefer to provide a personal service (rather than voicemail).

---

## Forward on Busy

If enabled, this forward will be triggered when the user is busy and another call is routed to them, but does not include calls for a hunt group that they may be a member of. A user is normally considered to be busy when they are on a call but depending on call waiting settings and key and lamp features this may not be the case.

---

## Forward on No Answer

This forward is triggered if a call has been ringing for a user but they haven't answered it within the configured answer time, this includes calls that have been indicating call waiting if enabled.

---

## Forward Unconditional

This sends all calls for the user to the forward unconditional number, but if the call is not answered within a user's timeout period the call will be sent to IP Office voicemail, if enabled.

---

## Unconditional Forward to Voicemail

### Feature

- The ability to forward calls to Voicemail, even when the user's voicemail is not activated.

### Benefit

- This feature allows a user who is familiar with the existing IP Office functionality of diverting all calls to a person or a group to follow the same pattern and divert all calls to a voicemail box.

---

## Forward Hunt Group

Calls for a hunt group that the user belongs to can also follow forward unconditional. The hunt group must be set for either sequential or rotary ring type and if the call is not answered at the forward destination it will follow the hunt group call handling instead of going to voicemail. This can be particularly useful in a sales or support environments where a number of people may be out of the office on Mobile/Cell telephones and still participate in the hunt group as if in the office.

---

## Follow Me

Follow Me gives mostly the same behaviors as the user's home phone (Paging, hands free answer, etc) whereas Forwarding doesn't. Follow Me is typically used when a user is going to be working away from their desk, for example in a workshop. All the call settings the user has on their main phone will apply to calls that follow the follow-me feature, including forward on busy or no answer.

Follow Me can be set either from the users main phone – Follow Me To – or from the phone where they want calls to be received – Follow Me Here. Several people can have their telephones forwarded to a follow me destination and if the phone has a display it will indicate who the call is for.

---

# Avaya Telephone Features

---

## Programmable Buttons

As well as the usual dialing keys, Avaya digital and IP telephones have dedicated function buttons like Mute, Volume, Hold, Conference and Transfer. In addition to these, on many Avaya digital and IP telephones there are keys that can be programmed with a range of selected special functions. These keys can be used for calling other extensions on the system (Direct Station Select or DSS keys), or can be used for options from speed dialing numbers to controlling features such as Do Not Disturb. Many features use an indicator to show whether a feature is enabled. Button programming is done through the IP Office Manager as part of the system configuration, although some telephones allow the user to program buttons and functions where given administration rights.

---

## Busy Lamp Field (BLF) Indicators

### Feature

- Status indicators which show the status of a programmable buttons associated feature or function.

### Benefit





- Indication of when a button or associated feature is active.

### Description

Avaya digital and IP telephones have programmable buttons which can be assigned to various features. When those buttons include some form of BLF indicator, the button can also be used to indicate when the feature is active. For example, a button associated with another user will indicate when that user is active on a call. A button associated with a group will indicate when the group has calls waiting to be answered.

The directory entries in Avaya one-X™ Portal for IP Office and the speed dial icons within the IP Office Phone Manager and SoftConsole applications also act as BLFs. When the icons are associated with internal users, the icons will change to indicate the current status of the users.

Avaya one-X™ Portal for IP Office shows these conditions:

State	Icon	Description
Available	available	The status indicates that you are available and can be called.
Busy		The status indicates that you have a call in progress.
Do Not Disturb		The status indicates that you have enabled <b>Do Not Disturb</b> on the phone system. Calls to you are redirected to voicemail if available. Otherwise, the callers receive a busy tone. The exception is calls from numbers that you have added to your list of <b>Do Not Disturb Exceptions</b> .
Logged Out		The status indicates that you have not logged into the extension on the phone system. Calls to you are redirected to voicemail if available. Otherwise, the callers receive a busy tone. You cannot make calls. However you can still use Avaya one-X™ Portal for IP Office to alter your configuration settings.
Ringing		This status indicates that the phone is ringing and you have an incoming call.
Unknown	unknown	This status indicates that your presence on the phone system is unknown. The presence cannot be determined as the phone number is not an extension on the IP Office

---

## Call History

### Feature

- Access to a list of called, received and missed calls from the phone and/or IP Office user productivity applications.

### Benefit

- Missed calls are easily tracked and can be returned.
- Call log data is retained even after power down and a system reset (1400, 1600, 9600, T3 and Avaya one-X™ Portal for IP Office).
- Centralized call log is supported in the SCN when using hotdesking (1400, 1600, 9600, T3 and Avaya one-X™ Portal for IP Office).

- Consistency between desktop telephones and user productivity application (1400, 1600, 9600, T3 and Avaya one-X™ Portal for IP Office).

### **Description**

IP Office keeps a record of calls made and received, including unanswered calls. Details are stored for both users (maximum 30 entries) and hunt groups (maximum 10 entries). The method of operation varies according to the phone type but in all cases the call records can be used for return calls.

Beginning with IP Office Release 6, a centralized call log is supported by 1400, 1600 and 9600 Series telephones (not 1403 or 1603/1603SW) and Avaya one-X™ Portal for IP Office (leading to consistency between the two). 5400 Series and 5600 Series call logs are stored on the phone.

Avaya one-X™ Portal for IP Office accesses the centralized call log and therefore presents a record of all calls even if the user's PC is switched off when a call is received. Call log entries can be added to the personal directory.

Avaya one-X™ Portal for IP Office can display call histories for all calls, missed calls, inbound calls and outbound calls. Entries in the call history can be used for return calls, sorted and added to the Avaya one-X™ Portal for IP Office local directory or speed dials.

---

## **Language**

Avaya digital and IP phone menus and displays are available in many languages and usually the system default setting will be applicable to all telephones, however it is possible to have language set on an extension by extension basis, this will also change the language of menus for IP Office Voicemail.

---

## **Centralized Personal Directory**

### **Feature**

The IP Office Personal Directory is a list of up to 100 numbers and associated names stored centrally in the system for a specific user. A directory entry can be used to label an incoming call on a caller display telephone or on a PC application. The directory also gives a system wide list of frequently used numbers for speed dialing via Avaya one-X™ Portal for IP Office, Phone Manager or a feature phone with a suitable display.

For example "Mr Smith" can be displayed when a known Caller ID is received. A user can also select "Mr Smith" in the Directory List in Phone Manager, Avaya one-X™ Portal for IP Office or on a display phone to speed dial this number.

### **Benefit**

- The user has a personal directory independent from the phone (1400, 1600, 9600 and T3 only) at which they are logged in
- The personal directory is always synchronized between telephone and Avaya one-X™ Portal for IP Office.

### **Description**

- The personal directory capability allows up to 100 entries per telephony user.
- The system limit is:
  - 10800 for IP Office 500 and IP Office 500V2.
  - 3600 for IP Office 412.
  - 1900 for IP Office 406 V2.
- All entries may be added, deleted or modified by Manager, Avaya one-X™ Portal for IP Office, a telephone, or an external service.
- The personal directory data is sent/updated whenever the user is logged in a SCN.

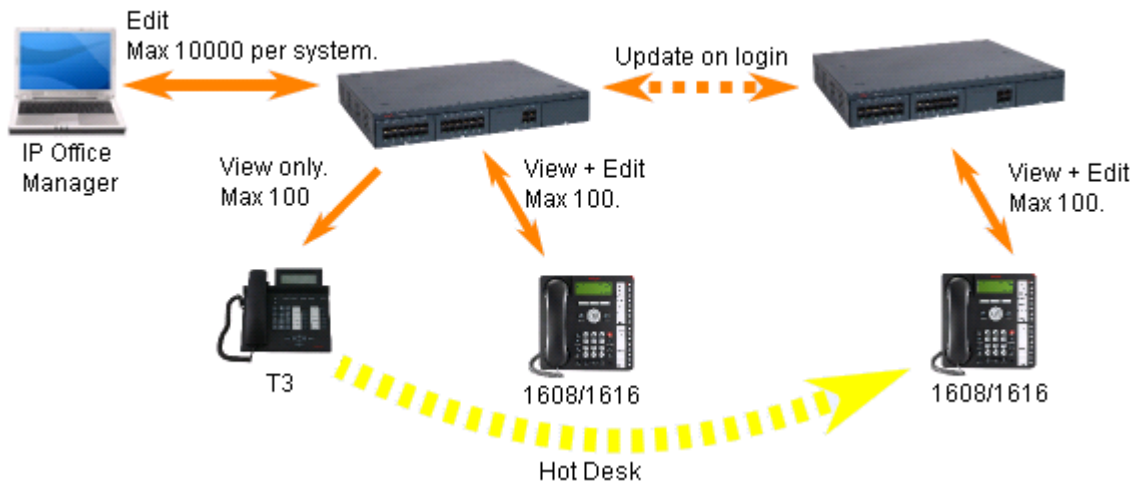

## Centralized System Directory

### Feature

The IP Office Directory is a list of up to 5000 numbers and associated names stored centrally in the system. A directory entry can be used to label an incoming call on a caller display telephone or on a PC application. The Centralized System Directory also gives a system wide list of frequently used numbers for speed dialing via Avaya one-X™ Portal for IP Office, Phone Manager or a feature phone with a suitable display.

For example "Head Office" can be displayed when a known Caller ID is received. A user can also select "Head Office" in Avaya one-X™ Portal for IP Office, or the Directory List in Phone Manager, or on the display phone Directory to speed dial this number.

### Description

- External directory entries can be obtained from up to three different sources for each IP Office:
  - Locally stored in the IP Office configuration. Created and edited using IP Office Manager or by selected 1600, T3 or Avaya one-X™ Portal for IP Office users.
  - Temporary entries imported at regular intervals from an LDAP server.
  - Temporary entries imported at regular intervals by HTTP from another IP Office. This allows the directory entries on one IP Office to be shared by other IP Offices as a centralized system directory for an SCN.
- The total maximum number of entries is 5000 with entries in the IP Office configuration taking priority over temporary imported entries.

	Manager	LDAP	HTTP	Overall Maximum
<b>IP500 IP500 V2</b>	2500	5000	5000	<b>5000</b>

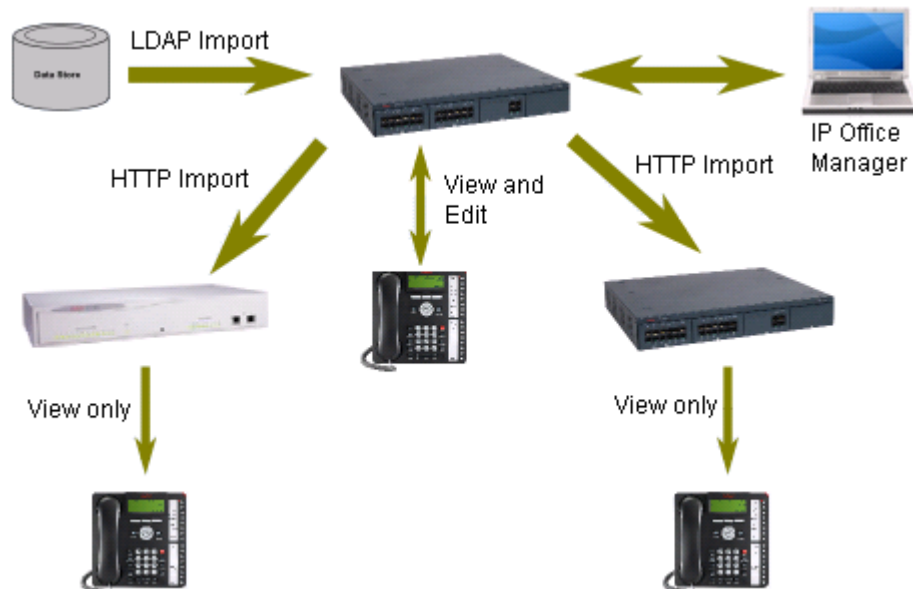

#### Benefit

- Ability to use external directory services with different interfaces
- One system directory for a Multi-Site Network (SCN)

---

## Self-Administration

The IP Office administrator may give select users the ability to change some of the phone settings themselves. For example, button programming. The range of changes that the user can make depends on the phone type in use.

---

## On Hook Dialing

Avaya digital and IP telephones allow the user to make calls by just dialing the number on the keypad, without having to lift the handset or pressing a speaker button. Usually the call progress can be monitored using the speaker in the phone, on telephones that support handsfree the whole conversation can be had without having to lift the handset.

---

## Inbound Call Handling

---

IP Office offers several features to provide versatile inbound call processing, including PC based applications, and a standards-based TAPI interface for 3<sup>rd</sup> party applications.

---

## Incoming Call Routing

Incoming calls can be presented to an Operator who then decides where to pass the call, but IP Office supports intelligent call routing capable of making routing decisions based on a number of criteria.

The system currently supports routing based on;

- Call presentation digits from the exchange such as DDI/DID or ISDN MSN.
- Calling telephone number or Caller ID (This could even be part of the number received such as an area code).
- ISDN sub-address.
- ISDN/PRI service type i.e. Voice Call, Data Call, etc.

It is even possible to look for multiple criteria so, for instance, a DDI/DID call to a sales group could be handled differently depending on which part of the country the call is originating from.

Each incoming Call Route also supports a secondary destination 'Night Service' that can provide alternative routing for an incoming call based on 'time of day' and 'day of week' criteria, as well as calendar-based routing for specific dates.

Calls that cannot be routed to the configured destination are re-routed to a user defined 'Fall Back' destination. This can be particularly useful where calls are normally answered by an auto-attendant and a network fault occurs.

Where multiple call routes are set up to the same destination, a Priority level can be associated with the call. This priority level is used to determine a call's queue position in place of simple arrival time, but note that calls already ringing a free extension are not considered queuing and are not affected by a high priority call joining a queue (unless the option "Assign Call On Agent Answer" is selected for that hunt group). A Priority Promotion Timer can be configured to increase the priority of calls which have been in the queue for more than a defined time.

An optional tag can be added to calls on the Incoming Call Route, which can be displayed on the alerting telephone.

---

## Hunt Groups

A hunt group is a collection of users, typically users handling similar types of calls, e.g. a sales department. An incoming caller wishing to speak to Sales can ring one number but the call can be answered by any number of extensions that are members of the hunt group.

Four modes of call presentation are supported on IP Office;

- **Sequential**  
One extension at a time sequentially always starting at the top of the list.
- **Collective**  
All extensions in the hunt group simultaneously.
- **Rotary**  
Start with the extension in the list immediately following the extension that answered the last hunt group call.
- **Longest Waiting**  
Start with the extension that has been free for the longest time.

An option has been added, "Assign Call On Agent Answer", which means that CTI applications will always correctly report the details for the call that is alerting. The "Assign Call On Agent Answer" and ensures that the call at the head of the queue is always answered first.

If all extensions in the hunt group are busy or not answered, another hunt group, called an Overflow Group, can be used to take the calls. An overflow time can be set to stipulate how long a call will queue before being passed to the Overflow Group (this can be configured either for individual calls or for all calls in the group). The system can change the status of users who do not answer a hunt group call presented to them. The user can be put into busy wrap-up, busy not available or logged out. The change of status can be set per user and the use of this option can be set per hunt group.

Outside normal operation a hunt group can be put into two special modes; Night Service and Out of service.



In Night Service calls are presented to a Night Service Group. This can be controlled automatically by setting a time profile which defines the hours of operation of the main group or manually using a phone feature code.

Night service fallback using a time profile is no longer applied to a hunt group already set to Out of Service.

The Out of Service mode is controlled manually from a phone. While in this mode calls are presented to the Out of Service group

Voicemail can also be used in conjunction with hunt groups to take all group related messages, play an announcement when the hunt group is in Night Service or Out of Service mode and give announcements while a call is held in a queue. For internal voicemail use a broadcast option is provided. This feature will alter the voicemail box operation so that the message notification will only be turned off for each hunt group member when they retrieve their own copy of the message.

---

## Multi-site Networking/Small Community Networking (SCN) Distributed Hunt Groups

Hunt groups in a Small Community Network can include members located on other systems within the network.

**Note:** Distributed Hunt Groups are not supported for use with CCC or CCR.

---

## Night Service

When a hunt group is in Night Service mode, the hunt group is temporarily disabled. Callers to this hunt group will:

- Pass to a Night Service Fallback group used to provide cover, e.g. pass calls to a manned extension or an external number
- Be played the Out of Hours greeting if voicemail is operational
- Receive the busy tone

A hunt group can be switched in or out of Night Service mode by a user dialing the appropriate short code – by any extension or by specific users.

---

## Time Profiles

Time Profiles can be used to define when a Service, Hunt Group, Least Cost Route, Conference Bridge or a user's dial-in facility are operational. For example, a time profile can be used to route hunt group calls to a manned extension or voicemail outside of office hours, or be used to apply different Least Cost Routes at varying times of day to take advantage of cheaper call rates. Multiple Time Entries can be created so that a Time Profile can be used to define specific hours in the day e.g. 09:00-12:00 and 13:00-17:00. Outside of a Time Profile, voice calls would be re-routed according to the configuration but any currently connected calls at the time the Time Profile changes would not get cut off as the change only affects the routing. Data calls will get cut off as the time profile goes out of service but a new data call will start immediately if specified. Time Profiles can also be based on specific calendar dates to make allowance for public holidays or other events.

---

## Queuing

Queuing allows calls to a hunt group to be held in a queue when all extensions in the group extension List are busy. When an extension becomes free the queued call is then presented. The definition of queued calls now includes ringing calls and calls waiting to be presented for ringing. The queue limit can be set to control the maximum number of calls to wait against a hunt group.

While queuing, if Voicemail is operational, the caller will be played the announcements for this hunt group.

---

## Announcements

Hunt group announcements are separated from hunt group queuing and can be used even when queuing is off. Hunt group announcements are now supported by Embedded Voicemail in addition to Voicemail Pro.

Further, times for the first announcement, second announcement, and between repeated announcements are configurable.

---

## Contact Center Features

---

Contact Centers have specific needs for reporting on how calls are handled and these are covered in a separate section of the Product Description. Basic handling of telephony requirements for a Call Center is a standard part of IP Office from Automatic Call Distribution (ACD) and Call Queuing to agents logging on and selecting the groups that they service.

---

### Login

A contact center agent function, login is required before the agent is able to make or receive calls from their phone. A login idle period can be specified which will dictate how long an extension can be idle before the user is automatically logged out, ensuring that an extension is not left logged in and calls go unanswered.

---

### Monitor Calls

A user can monitor other peoples' calls by listening in. This feature is not available by default; it must be specifically enabled in the system configuration. An option exists to have a beep tone indicate when monitoring is in use. The user is only able to listen; they cannot speak into the conversation being monitored.

---

### Acquire Call

#### Feature

- Takeover a call currently connected at another extension. This feature is also known as "Call Steal".

#### Benefit

- Assist a colleague who indicates they want you to take the call.

#### Description

The Acquire Call function can be setup as a special short code or programmed against a button on an Avaya digital or IP phone with programmable buttons. Use of the feature is subject to IP Office intrusion control settings, the user acquiring the call must be set to be able to intrude and the user whose call is being acquired must be set to can be intruded. Acquire call works in two ways, invoked with or without a number:

Without a value in the number field

- This allows a user to reclaim a call that was ringing on their phone but has now gone elsewhere, for example to Voicemail or Forward No Answer destination. The Intrude settings are not checked and the call can be reclaimed even if it has been answered.
- If the last call to ring this User is no longer ringing or connected on the system, the feature will fail.

With a number, where the number is the telephone number of a user who currently has the call to be acquired.

- If the user has a call ringing or waiting Acquire Call will act like the Call Pickup Extension short code and the user executing Acquire Call will be connected to the oldest ringing/waiting call.
- If the User has a connected call with no call waiting and the Intrude settings of the two Users allow it, the call will be connected to the user executing the Acquire Call and the other user will be disconnected.
- If the User does not have a call the feature will fail.

---

### Queue Threshold Alert

When the number of calls queued against a hunt group exceed a threshold, the system can be configured to alert at a selected analog extension port. Typically the User to Alert will be a loud ringer or other alerting device. The alert does not present a real call.

---

## Miscellaneous Features

---

### Conference Calls

Calls can be placed on hold and a conference created using either the phone or desktop applications. Additional conference members may be added, however a single conference may not have more than 64 members.

For the IP500 and IP500 V2 the total conferencing capacity is 128 channels. This could be alternatively 2 conference of 64 users, 3 conferences of 42 users or any other combination (maximum 64 participants per conference call).

Only two calls connecting through analog trunks are permitted in any single conference.

For more information on managing conference calls, refer to the [Audio Conferencing chapter](#)<sup>[393]</sup>.

---

### Coaching/Silent Intrusion/Whisper Page

This feature is available with Essential Edition, Preferred and Advanced Editions.

Silent Intrusion or Whisper Page can be effective in a scenario where a secretary/administration support intrudes into a call of his/her boss to whisper that a very important customer is waiting. The boss hears his/her secretary while talking to the caller but the caller will not be able to hear the secretary.

#### Feature

- Allows for the interruption or inclusion of a supervisor, co-worker to join a call without far end caller listening to the conversation.

#### Benefit

- Used in call center scenarios and with other applications between employees. Supports the interruption or inclusion of a supervisor on a live call to talk to an agent without the far-end caller listening to the conversation. This is useful when the agent needs coaching support/training or when the supervisor needs to intrude to give instructions to an agent. The caller may still talk to the agent, but the caller will not hear what the supervisor is saying. The agent will be able to hear both the caller and the supervisor.

#### Description

The feature enables users on a call to 'intrude' and listen depending on the configuration of the end users, i.e. whether Coaching Intrusion or Whisper Page is used. Coaching intrusion and Whisper page cannot be done on and idle user. It may be done for internal calls or with external calls. This feature is enable through the IP Office manager for each IP Office user. Only authorized users can use the coach/whisper feature. Default setting is off.

---

### Dial On Pickup

Also known as "Hotline". Automatically dials a specified extension when the phone is taken off hook. This facility is commonly used in unmanned reception areas or for door entry systems to allow visitors to easily gain assistance.

---

### Off Hook Operation

Off-Hook Station is designed for users who want their analog phone to operate like digital or IP feature phone, to isolate the user's phone idle state from the Hook state. This is a useful feature when using Avaya one-X™ Portal for IP Office, Phone Manager or SoftConsole to control the phone state when using a headset on an analog telephone and with call control and dialing from Avaya one-X™ Portal for IP Office, or SoftConsole.

---

### E911 / Emergency Call

This is a specific service for North America. When an emergency call is connected, IP Office provides calling party information to an external line interface unit. The external unit carries out a number to text translation and forwards this to the emergency services bureau so that the originating location of the call is clearly identified.

---

# System Short Codes

---

Short codes are used as commands the IP Office to make changes for the user, group or system, so need to set up with consideration to security. The command may need additional information included with it, such as for forward, the phone number forwarded to. Short codes are a flexible and quick way of setting up certain features. IP Office has short codes provided by default on the system, or more advanced codes that need programming by the system administrator.

## Examples

The method of detailing a short codes settings lists the short code fields separated by a /.

- **\*17/?U/VoicemailCollect**  
A user dialing \*17 is connected to voicemail.
- **\*14\*N#/N/FollowMeTo**  
If a user dials \*14\*210# at their own extension, their calls are redirected to extension 210.

## Dialing Short Codes

The following types of short code applied to on-switch dialing. The result may be an action to be performed by the IP Office, a change to the user's settings or a number to be dialed. The order below is the order of priority in which they are used when applied to user dialing.

### User Short Codes

These are useable by the specific user only.

### User Rights/User Restrictions Short Codes

These are useable by any users associated with the user rights or restrictions in which they are set. They can be overridden by individual user short codes.

User and User Rights short codes are only applied to numbers dialed by that user. For example they are not applied to calls forwarded via the user.

### System Short Codes

These are available to all users on the IP Office system. They can be overridden by user or user rights short codes.

## Post-Dialing Short Codes

When any the short code above result in a number to be dialed, further short code can be applied to that number to be dialed. This is done using the following types of short codes.

### ARS (Alternate Route Selection) Short Codes

The short code that matches dialing can specify that the resulting number should be passed to an ARS form. The ARS form can specify which routes should be used for the call by using further short code matches and also provide option to use other ARS forms based on other factors such as time and availability of routes.

### Transit Network Selection (TNS) Short Codes

Used on T1 ISDN trunks set to use AT&T as the Provider. Applied to the digits presented following any other short code processing.

## Incoming Number Short Codes

On certain types of trunks short codes can be applied to the incoming digits received with calls.

### Line Short Codes

These short codes are used to translate incoming digits received with calls. The stage at which they are applied varies between different line types and may be overridden by an extension number match

The full set of short code commands are listed in the IP Office Manager, refer to product configuration documents for more detail on how to set them up.

# Chapter 8.

# IP Telephony

## 8. IP Telephony

Technological innovation is changing the way we communicate. This time it is coming in the form of changing the way telephone calls are transmitted. It brings with it several new capabilities that change the meaning of the phrase telephone call through the use of Voice over Internet Protocol (VoIP). Basically, VoIP means "voice transmitted over a packet data network." VoIP is often referred to as IP Telephony because it uses the IP protocols to make possible enhanced voice communications throughout the world, wherever IP connections have been delivered. IP Telephony unites a company's many locations- including mobile workers- into a single converged communications network. Telephony calls using VoIP go above and beyond what's been possible in the past. When it comes to placing telephone calls, VoIP provides a range of support services and features unequalled in the world of telephony, but above all delivers them at low cost.

### How Does VoIP Work?

Voice over Internet Protocol means basically what the acronym states: Voice travels over an Internet Protocol. Internet Protocol refers to the type of rules that the network uses to send and receive signals. IP Telephony works by converting voice communications into data packets. Conveniently, it runs on the popular Ethernet LAN (local area network) technology, which currently supports over 96 percent of the worlds companies' LANs.

### Circuit-switched or Time-Division Multiplexed Telephony

Before digital networking with the Internet took off, everyone had to use the "Plain Old Telephone Services" (POTS). These run over a network called the Public Switched Telephone Network (PSTN). The PSTN has been around since the telephone was invented in either analog or digital form using circuit switched technology where the telephone call gets exclusive bi-directional use of a wire – or circuit – while the call is in progress. Because the circuit is exclusive to each conversation, PSTN and private branch exchanges (PBXs) must be sized to cope with peak demand and have enough circuits available for all expected conversations. This is not a flexible approach and results in a lot of infrastructure investment that the telephone companies need to recoup, via the cost of access charges and calls. The Internet has changed this – where data services have driven down access charges and allowed voice to "travel for free" over a multipurpose data network.

### Packet-Switched Telephony

Unlike circuit-switched connections, which always require use of dedicated bi-directional circuit for the duration of a call, VoIP technology has enabled telephony and other new and novel features and services to run over fixed and wireless networks including private local area networks. These newer network types use packet-switched protocols. Packet-switched VoIP puts voice signals into packets. Along with the voice signals, VoIP packets include both the sender's and receiver's network addresses. VoIP packets can traverse any VoIP-compatible network. Along the way, they can choose alternate, shared paths because the destination address is included in the packet. The routing of the packets is not dependent on any particular network route which means the network provides can provide a reliable service at a fraction of the cost of circuit switched providers.

### What Advantage Does IP Office Have?

IP Office can provide support of PSTN, SIP, POTS, digital time division multiplexed telephones AND digital IP telephones all on the same system. This means you don't have to abandon the past to embrace the future, IP Office allows all the technologies to co-exist. IP Office connects to the PSTN and to IP trunks (the VoIP equivalent) so providing a "Hybrid" PBX function – where both legacy and future technologies can be used together to minimize operating costs and optimize business communications through both voice and data.

IP Office has digital telephones built on both TDM and IP technology that provide the same user interface offering a flexible choice of solution that can mix, for example TDM telephones in the office and IP telephones at a remote site or at home. With the choice of IP telephones including real and virtual (software) telephones, IP Office can take communications to a new level.

Buying IP Office allows you choice – you can use the pure POTS or the pure VoIP capabilities of IP Office, or use both at the same time to allow seamless technology transition of your business without the disruption of having to choose between them now.

## IP Office and IP Telephony

In order to make use of VoIP, IP Office uses signaling protocols called H.323, and Session Initiation Protocol (SIP) which allow IP Office to establish end-to-end connections for the voice path through the IP network. It ensures each end of the connection is able to transmit and receive voice and provides the network addressing for end to end packet transmission. IP Office also allows for connecting between the different technologies by translating the signals they use, for example an analog telephone may wish to connect to a VoIP destination. This requires both the signaling and voice transmission to be translated – IP Office does this easily as it contains technology elements called gateways and gatekeepers that enable translations to happen.

With a conventional telephone system you plug your analog or digital TDM telephone into an extension socket connected to your PBX or Key System. With IP Telephony you connect your IP telephone to your IP PBX via the LAN. There are two basic types of IP telephones:

- A physical telephone, which looks very similar to a standard telephone (IP Hard Phone)
- A software application (IP Office Video Softphone) which runs on the user's PC, allowing them to use either a headset/microphone to make/receive calls anywhere they have IP connection

IP telephony has the advantage of allowing extensions to be deployed both locally and remotely through the use of IP routing and IP VPN services.

When making use of IP telephony, there are a number of data centric considerations such as which data types have priority on the IP network when there is contention. This is set with IP/TCP "quality of service" and should not be ignored. In situations where LAN Bandwidth is limited, a quality of service capable LAN switch should be used to ensure voice packets are transmitted with the required priority on the network. If not, the conversation carried over IP appears as broken up (due to delays) or has unacceptable delays introduced in the conversation (latency and jitter). With IP hardphones there is need for Power over Ethernet (PoE), or local phone power supplies to be provided to the telephones as the IP telephones are no longer powered by IP Office – a list of Avaya approved PoE options is available at the end of this section.

---

## Gateways, Gatekeepers and H.323 - Technology Overview

---

IP Office uses the H.323 signaling protocol which has the following architectural components

- Telephones are H.323 service endpoint devices that can support Audio calls. Other types of H.323 devices can support video as part of H.323
- Gateways provide media translation to allow calls to be made to non-H.323 devices, for instance an analog telephone or the public network to connect with a H.323 device
- Gatekeepers control the call processing and security for H.323 devices
- Multipoint Connection Units (MCU) for conferences by adding together media streams

These elements are grouped together in what is known as an H.323 zone (a zone is analogous to a PABX). Each zone has a single Gatekeeper that can be considered as the brains of the system dealing with call distribution, call control and the management of resources. On power-up, IP telephones, Gateways and MCU make registration requests to a Gatekeeper which then authenticates (accepts or rejects) their request to become a member of the zone. Once accepted, a telephone wishing to make a call sends a call set-up message to the Gatekeeper which then determines how to route the call and will then send an alert to the called telephone, or if the call is to a non-H.323 telephone establish the call via a Gateway within the zone.

The design of IP Telephony systems has been driven by open standards. Digital IP telephones, Gateways and Gatekeepers all support the H.323 standard and it is this that allows devices from different manufacturers to work together. IP Office has an optional integral Gateway (Voice Compression Modules) and Gatekeeper functionality required to provide a fully functional IP Telephony solution.

---

## SIP - Session Initiation Protocol

---

IP Office supports SIP, which is a signaling protocol used for creating session oriented connections between two or more locations in an IP network. SIP trunking is a service offered by an ITSP (Internet Telephony Service Provider) that permits businesses with an IP Office installed to use Voice-over-IP (VoIP) outside the enterprise network by using the same connection as in Internet connection.



# IP Telephony Features

- Gatekeeper**  
The IP Office gatekeeper allows the registration of up to 384 IP extensions on the IP500, less the number of analog and digital TDM telephones already configured on the system.
- Gateway**  
The Voice Compression Module provides the H.323 gateway function that allows IP extensions to make calls to other non-IP devices. The maximum number of simultaneous calls is limited by the number of channels available on the Voice Compression Module. IP Office must be fitted with an optional Voice Compression Module to enable IP telephony.
- Silence Suppression**  
Silence suppression is a technique used to make the best use of available bandwidth, such as the connection over which the caller is listening, not speaking. Silence suppression works by sending descriptions of the background noise, rather than the actual noise itself, during gaps in conversation, thereby reducing the number and frequency of voice packets sent on the network. Background noise is very important during a telephone call. Without noise the call will feel very unnatural and give a perception of poor quality. Ensure that silence suppression configuration matches at both ends of the SCN trunk for correct operation and also for improved sound quality.
- Compression**  
IP Office supports a wide range of voice compression standards including G.711, G.729a and G.722. The method of compression can be either automatically established on a call-by-call basis or configured on an individual extension basis. G.722 is supported with R8 on SIP Trunks, the 9600 Series sets, 96x1 Series Sets, B179 Conference Phones, IP Office Video Softphone, 1100/1200 IP Phones and 3<sup>rd</sup> party SIP phones. G.722 is not supported for 5600 and 1600 Series sets.
- Fast Start**  
When fast start is supported by an IP extension, this facility reduces the protocol overhead allowing an audio path to be established more quickly.
- Out of Band DTMF**  
When out of Band DTMF is configured on an IP extension, the extension will signal to the other end of the connection which digits need to be regenerated by a local DTMF generator on behalf of the sending IP extension. This is useful when navigating external voicemail systems and Auto-Attendants.
- Direct Media Path**  
Direct Media Path allows the speech path between two IP extensions (after call setup) to be routed directly to each other. This allows the IP Office system to free up voice compression resources after establishing the end to end connection, allowing the resources to be used in the most efficient way.
- Auto-Create Extensions**  
IP Office can automatically create an extension entry for new IP telephones added onto the local area network. In cases where the local area network is not secure this facility can be disabled, but simplifies installation of IP telephone systems
- Fax Transport (Avaya Proprietary)**  
Fax Transport allows fax calls to be routed over VoIP trunks between IP Office systems on an IP network using a proprietary IP Office transport protocol.
- Fax Transport T.38**  
IP Office supports the standardized protocol "T.38" for transporting FAX calls between IP Office and SIP trunks or SIP endpoints. T.38 is only supported on IP Office 500 hardware. It requires the IP Office to be equipped with VCM 32 or VCM 64 modules.

T.38 allows the reliable transmission of Fax messages over a IP channel independent of Codec used for the Voice communication.

<b>Platforms Supported:</b>	IP500, IP500 V2 only, must be fitted with VCM32 or VCM64 module.
<b>Trunk Types Supported:</b>	SIP
<b>Extensions Supported:</b>	SIP
<b>T.38 Transport Layers Supported:</b>	UDPTL (with optional redundancy error correction).
<b>T.38 Versions Supported:</b>	0-3
<b>Call Types Supported:</b>	Voice calls which transition to fax relay on detection of fax tones. Calls which are negotiated as fax only.

- **T.38 Fax Fallback (new in Release 8)**  
SIP Trunks and SIP Extensions can now configure the "Fax Transport Support" to "T38 Fallback" so that outgoing fax calls use T38 fax, but when the called destination doesn't support T.38 and rejects the call, a re-invite is sent for fax transport over G.711. Incoming audio calls that detect fax tones also initiate fax transport using T.38 Fallback. This allows IP Office to support additional deployments where T.38 fax may not be universally available.
- **Display Directory Name on In-Bound SIP Trunk Calls (new in Release 8)**  
IP Office Manager will now include a configuration option that will allow the selection of either the CLID or directory name as the default display for inbound calls. In previous IP Office releases only CLID display was supported over SIP trunks for incoming calls. This enhances IP Office user experience by providing the flexibility to select between personalizing the display with the personal or system directory name, and seeing the default CLID.
- **Enhanced CLIR (new in Release 8)**  
Enable SIP Trunk PAI and Privacy headers by default, and format "From, PAI and Privacy." This feature allows caller and calling party anonymity while still providing the necessary billing and traceability information (E911 services) to the network. This enhancement aligns the functionality with implementation guidelines outlined in the SIPconnect 1.1 Technical Recommendation.
- **Early Media and Support for PRACK (new in Release 8)**  
SIP trunks can be configured to support early media by adding "100rel to Supported" header in the INVITE: This allows support for in-band announcements such as: branding from discount or bulk long distance providers; caller comfort in terms of progress indications when extraordinary wait times are inherent in the call scenario, for instance when trying to locate a cell phone; as well as, the ability to provide country specific ring back and other progress tones. This feature also facilitates the ability to set up conferences in the IP domain before call answer, for instance, in certain call recording scenarios or for automatic dialers' conferencing in agents.

---

## SIP Trunks

---

In IP Office Release 8.1, SIP Trunk enhancements have been included that allow service providers to continue to broaden their SIP trunk offerings.

SME customers are increasingly evaluating and adopting SIP trunks. IP Office Release 8.1 responds to these market trends, with several new SIP trunk capabilities, designed to simplify and address a wider set of implementation scenarios.

The IP Office architecture brings the benefits of Session Initiated Protocol (SIP) to the enterprise customer through SIP Service Providers. To help enable the SIP Service Provider, Avaya offers a SIP Compliance Testing Program (GSSCP) that will validate the operation of the IP Office solution with the Service Provider's SIP trunk offering.

For more information about Avaya's SIP Compliance Testing Program (GSSCP), please refer to the following link:

<https://enterpriseportal.avaya.com/ptlWeb/bp/so/CS201172610238111040>

---

## SIP Trunk Capabilities

### **SIP From in Clear when privacy is requested**

Many SIP Service Providers require that the **From** field contain account information for outbound calls. SIP Lines will now support the **Send From in Clear** field. IP Office will send the caller ID in the clear in the SIP From header for outbound anonymous calls. The default of **Send From in Clear** is disabled. This new capability is configurable on a per line basis.

### **SIP User-Agent header included to identify IPO in SIP trunk calls**

IP Office identifier will now be included in the SIP header. This addition will enhance troubleshooting capabilities when additional identification is required. The identifier will be configurable as the system administrator is permitted to enter identifying (User-Agent) information into the SIP messages. User-Agent headers are generated for IP Office initiative messages such as INVITE, OPTIONS, CANCEL, etc. This feature will also support enhanced SIP Server header information in all 18x response messages such as Trying, Ringing, etc.

### **IP Office can send UPDATE without SDP for session refresh over SIP trunks**

The addition of this new audit mechanism will validate that the connection is in place. If not, the IP Office will free the trunk, thereby improving network resource utilization.

IP Office can now negotiate RFC 4028 for session refresh over SIP Trunks. It can either be the refresher or will expect UPDATE messages from remote party, depending on negotiation. The session will be terminated if IP Office doesn't receive an UPDATE/200 OK message for session refresh. In earlier IP Office releases, RE-INVITE messages were used as the refresher. IP Office 8.1 is now RFC 4028-compliant. By default, UPDATE Supported is not enabled and IP Office will send RE-INVITE messages for session refresh. If UPDATE Supported is Allow or Auto and the other party supports UPDATE (specified in the "Allow" header), IP Office will send UPDATE messages for session refresh.

### **From header shall be used by IPO as calling identity whatever presence of P-Asserted-Identity (PAI)**

Although service providers typically use PAI for Caller ID delivery, additional flexibility is sometimes required. IP Office answers this requirement by providing an option to use the From header. The administrator will have the option of selecting which Caller ID information to use for displaying on the user equipment. By default, IP Office will display PAI caller ID present in the SIP/Tel URI consistent with pre-R8.1 behavior. If the checkbox is set, the caller ID present in the From SIP URI will be used instead.

### **Turn off OPTIONS if registration can do keep-alive**

Some service provider implementations utilize registration to maintain the status of lines instead of OPTIONS. In IP Office 8.0, OPTIONS requests are sent to regularly check if the SIP Line is in service. With Release 8.1, it is possible to send frequent REGISTER requests to keep the line in service rather than using OPTIONS.

### **Fax G711 pass through mode including SG3**

Super G3 fax machines utilize higher speeds than normal G3 or earlier fax machines. In order to broaden IP Office fax support, Release 8.1 now supports Super G3 fax transmission.

IP Office 7.0 added Fax Transport support for sending and receiving of faxes over G.711. IP Office Release 8.1 will now detect fax tones in G.711 calls between Super G3 fax machines.

### **IP Office should support nonce-caching for proactive inserting SIP credentials in outgoing SIP requests**

Currently, IP Office sends the Authorization/Proxy-Authorization only if the network specifically requests this for one IP Office request. In R8.1, IP Office will now cache the nonce received with the challenge or with the Authentication-Info header. IP Office will use the information for proactively inserting the SIP credentials in all the outgoing SIP messages.

The support of nonce-caching will speed authentication, reduce network signaling traffic, and improve the efficiency of message handling by IP Office.

**All outgoing SIP requests may be authenticated by SIP network with the exception of Cancel method**

IP Office will now support additional levels of authentication by broadening the scope of message types to which the IP Office will respond.

All methods shall support presence of (proxy) authorization headers except Cancel (RFC compliance). At present, Invite, Re-Invite, Update, and BYE shall support the presence of such headers. Before the introduction of these changes, IP Office did not support challenges for Update message.

**Template support for new features included in SIP Trunk**

In IP Office Release 8.1, each of the new Manager configuration settings have been added to SIP Line templates.

---

# SIP Endpoint Support

---

*Session Initiation Protocol (SIP)* is an open signaling protocol for establishing any kind of real-time communication session. The communication session can involve voice, video, or instant messaging, and can take place on one of many devices that people use for communicating: laptop computer, PDA, cell phone, IM client, IP phone, and so on. SIP has been developed in the *Internet Engineering Task Force (IETF)* by common participation from various vendors, including Avaya.

Avaya IP Office supports SIP for telephony functions to enable the usage of standard based SIP endpoints for Voice and Fax communication. In pure SIP systems, IP Office expands the feature set beyond the SIP standard, offering a wealth of IP Office features also on SIP endpoints delivering a feature rich system that a pure-SIP server based on the SIP standard only can't deliver. With that, IP Office delivers the best of both worlds, supporting standard based IP telephones while delivering a wealth of features consistently between SIP, digital and Avaya IP endpoints.

IP Office SIP endpoint implementation is built on two major SIP components: SIP User agents, and SIP Server components.

## SIP Components

### SIP Endpoints (User Agents)

User agents (UAs) are applications in SIP endpoints (such as a SIP phone, cell phone, PDA, or workstation) that interface between the user and the SIP network.

### SIP Servers

IP Office has implemented the required functionality of the SIP servers mentioned below not only to provide SIP endpoint support but also to allow full interoperability between SIP endpoints, other IP telephones based on H.323, Digital and Analog telephones as well as IP Office trunks (Analog, digital or SIP based)

SIP servers provide centralized information and enablement services in a SIP ecosystem. The core SIP servers and their functions are summarized here. IP Office provides the required the features of the following two servers for Voice and FAX communication.

- **Registrar Server**  
When SIP IP telephones come online, they need to make sure that others are aware that they're available to take and make calls. The Registrar authenticates and registers the IP phone (often directly related to a specific user) when it comes online, and then stores information on the telephones logical identities.
- **Proxy Server**  
A proxy server takes SIP requests, processes them, and passes them downstream while sending responses upstream to other SIP servers or devices. A proxy server may act as both a server and a client, and can modify a SIP request before passing it along. A proxy is involved only in the setup and teardown of a communication session. After user agents establish a session, communications occur directly between the parties.

Functionality of the following two SIP servers are generally available by IP Office using existing IP Office functionality. Therefore, while functionality is provided, e.g. allowing hot desking (also for users using a SIP-endpoint) in a small community network, a consistent methodology between SIP and non SIP endpoints is used to deliver those features

- **Location Service**  
As users roam, the network needs to be continually aware of their locations. The location service is a database that keeps track of users and their locations. The location service gets its input from the registrar server and provides key information to the proxy and redirect servers. IP Office provides hot desking support, delivering a similar functionality but working consistently between SIP and non SIP endpoints.

- **Redirect Server**  
If users are not in their home domains, sessions bound for them needs to be redirected to them.

The redirect server maps a SIP request destined for a user to the device "closest" to the user. In IP Office, call forwarding and Follow me functionality is used to provide again consistent functionality between all type of endpoints.

## Supported functionality for SIP endpoints in IP Office

SIP endpoints are supported on IP Office for Voice (Audio) and Fax (T.38) communication.

This allows the usage of standard compliant IP telephones using the open SIP standard, giving customers a choice of endpoints of different manufacturers including special purpose devices like conference telephones, hotel telephones or terminal adapters.

In order to use a non-Avaya SIP endpoint with IP Office, a "Third party IP endpoint license" is needed. This license will continue to support endpoints based on the H.323 standard but will also be required for generic SIP endpoints on IP Office. Avaya IP Office SIP telephones use the IP End Point license.

SIP Endpoint support is fully integrated into IP Office core. No other components are needed. SIP endpoints will need VCM module capacity in IP Office like any other IP phone.

Next to SIP telephones, SIP terminal adapters are supported to connect analog telephones and fax machines. This offers a flexibility to support Fax machines and Audio/T.38

SIP extensions function like any other IP Office extension: This means they

- Can make and receive calls to any other extension, independent of type of extension
- Delivers end to end Media just like any other IP telephone on IP Office. For calls between two SIP extensions of a SIP extension and an Avaya IP telephone, the audio is transmitted end to end for basic telephone calls. (Conferences etc. However require a VCM resource). See chapter "VCM modules" for details
- Can use short codes and authorization codes like any other telephones
- Transmit In band call progress tones are delivered from IP Office
- A SIP telephones needs to register with IP Office like any other IP telephone, Authentication with Username and password is possible
- SIP extensions support "auto create" in IP Office to make installation fast and efficient. Successful registration of an endpoint will consume one third party license
- On one IP address, several extensions can register with IP Office, each consuming a license. This enables the connection of SIP terminal adapters with more than one analogue port, giving a different extension number to each of the ports.

**Advanced features:**

SIP endpoints support a number of extended features according to the "SIP service samples-draft", also referred to as "Sipping-19". This includes:

- **Calling line identification**
- **Hold/Consultation Hold**
- **Attended/Unattended Transfer**
- **Message Waiting**
- **Do not disturb**
- **Conference Add**

Some telephones support several call appearances making it easy to switch between calls. Please note that this does not include "bridged appearances" or "(outside)-line appearances."

A large number of additional features are supported on IP Office using Feature activation keys. These features include but not limited to:

- **Call forward: Unconditional/Busy/no Answer**
- **Follow me**
- **Park/Unpark**
- **Music on Hold**
- **Meet me conferencing**
- **Conference join**
- **Ring back when free**

SIP endpoints also support Computer Telephony Integration "CTI" and therefore applications like Avaya one-X™ Portal for IP Office: the following features are supported with Avaya one-X™ Portal for IP Office and via the TAPI interface:

- **Outgoing call** (*without remote activation of speakerphone/headset*)
- **Hang up**
- **Hold**
- **Attended/Unattended transfer**
- **Conference** (*IP Office based*)
- **Voicemail collect**

- **Set forwarding/DND** (*IP Office based*)
- **Park/Ride** (*IP Office based*)

The features work similar like "CTI" features in combination with an analog telephone, e.g. an outgoing call will first ring the SIP phone and after connect the outgoing call will be placed. Avaya Phone Manager/ Phone Manager Pro and Soft console are currently not supported in combination with SIP-endpoints.

### Session Initiation Protocol

- Rec. E.164 [2] - ITU-T Recommendation E.164: The international public telecommunication numbering plan
- RFC 2833 [7] - RTP Payload for DTMF Digits, Telephony Tones and Telephony Signals
- RFC 3261 [8] - SIP: Session Initiation Protocol
- RFC 3263 [10] - Session Initiation Protocol (SIP): Locating SIP Servers
- RFC 3264 [11] - An Offer/Answer Model with Session Description Protocol (SDP)
- RFC 3323 [14] - A Privacy Mechanism for the Session Initiation Protocol (SIP)
- RFC 3489 [18] - STUN - Simple Traversal of User Datagram Protocol (UDP) Through Network Address Translators (NATs)
- RFC 3824 [24] - Using E.164 numbers with the Session Initiation Protocol (SIP)
- RFC 1889 - RTP
- RFC 1890 - RTP Audio
- RFC 4566 - SDP
- RFC 3265 - Event Notification
- RFC 3515 - SIP Refer
- RFC 3842 - Message Waiting
- RFC 3310 - Authentication
- RFC 2976 - INFO
- RFC 3323 - Privacy for SIP (PAI) and draft-ietf-sip-privacy-04 (RPID)

For codecs supported, refer to chapter to [VoIP Standards Supported](#).

While great care has been taken to be compliant with SIP standards, no guarantee can be given that all devices claiming support of SIP will work flawlessly. The SIP standard is constantly evolving with new features and methods introduced. Also, while being standard compliant, not all devices implement all options of the standard, making it hard to almost impossible to predict if a device will work- Avaya will only confirm functionality of devices that we have tested and will publish a list of devices that have been tested including – if required – implementation details and software version used on that device.

At the time of writing, the following devices have been tested successfully for Audio and/or Fax transmission.

<b>SIP Telephones:</b>	<ul style="list-style-type: none"> <li>• Polycom Soundpoint IP 320, IP 601</li> <li>• Avaya 1100 Series/1200 Series</li> <li>• Avaya B179 conference phone</li> </ul>
<b>SIP clients on mobile cell telephones:</b>	<ul style="list-style-type: none"> <li>• Nokia S60 v3 SIP client (e.g. Nokia E61i mobile cell phone) MAC and Windows versions</li> </ul>
<b>SIP Analog Terminal Adapters</b>	<ul style="list-style-type: none"> <li>• Quick Edition A10 ATA</li> <li>• Patton single line M-ATA</li> <li>• Innovaphone IP22, IP24, IP28</li> </ul>
<b>SIP PC-based softphones:</b>	<ul style="list-style-type: none"> <li>• CounterPath eyebeam/xlite</li> </ul>
<b>Softphone</b>	<ul style="list-style-type: none"> <li>• IP Office Video Softphone (Using advanced SIP features): Does not require a "SIP-station" license but works as part of the user package.</li> </ul>
<b>Video enabled devices</b>	<ul style="list-style-type: none"> <li>• Avaya 1010 Video</li> <li>• Avaya 1040 Video with 4-party MCU</li> <li>• Polycom VVX 1500</li> </ul>

A list will be provided in the IP Office knowledge base and on <http://support.avaya.com>

## Supported functionality for SIP communication in IP Office

IP Office – since Release 6.1 supports both Video and Audio communication for SIP devices.

It is therefore possible to connect a Video-endpoint to IP Office for rich multimedia communication:

Video is supported

- In an IP Office system locally
- In a IP Office small Community network
- To a Video-ready SIP trunk, e.g. to Avaya Aura

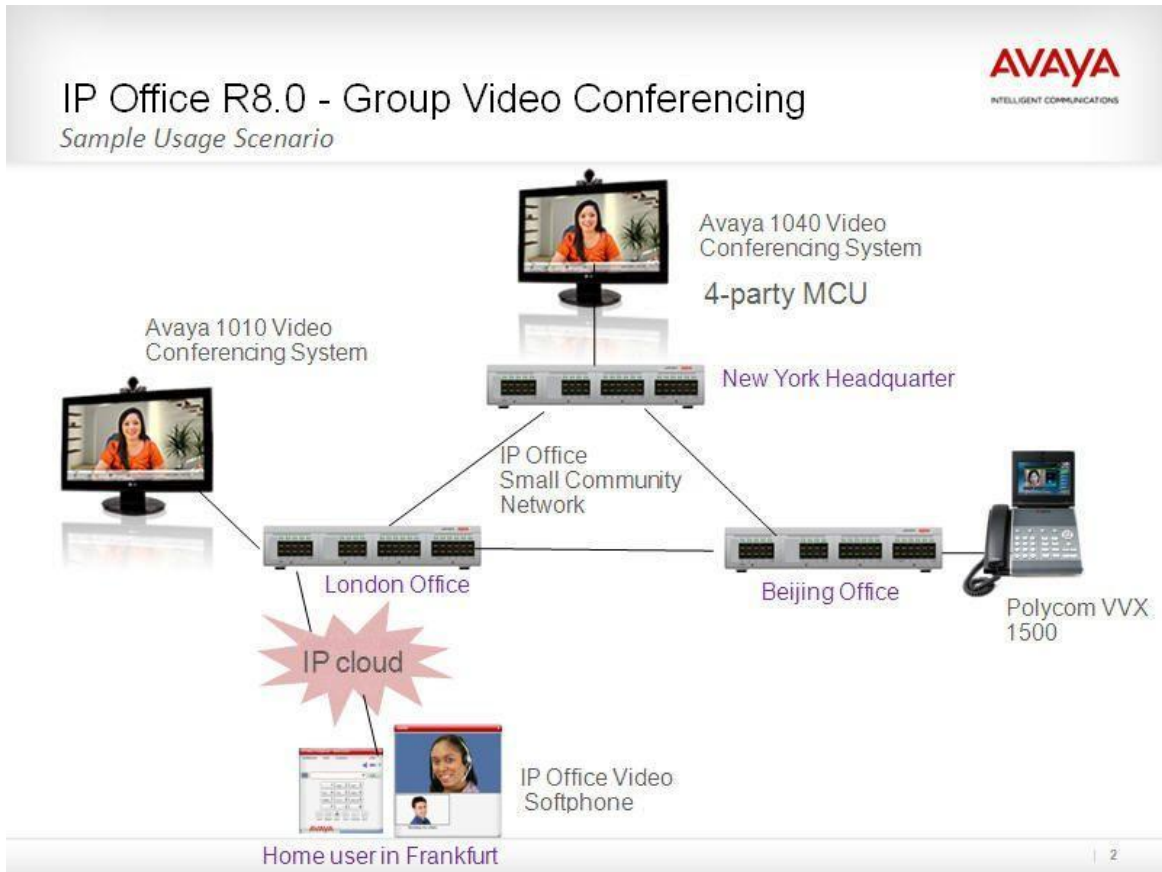

A few typical Call scenarios:

- End to end Video call in an IP Office system: E.g. a call from a Video Softphone to an Avaya 1010 system in a senior manager's office.
- Video in a Small Community Network: Calls e.g. between two Avaya 1010 telephones in the headquarter and a remote Office on the SCN
- Video Conference leveraging the Avaya 1040 Video Conferencing system. One user can use the 1040 while three other users are e.g. in remote locations on a SCN, home office etc.
- Multi-party video call using the softclient-based video-conferencing capability. In this case, all video conference participants use the IP Office Video Softclient.

Video details:

- All video communication is end to end, meaning that IP Office does not natively manage or perform video conferencing.
- The softphone handles all video conferencing initiated by users logged into the softphone.
- Video endpoints can make calls to all telephones and trunk lines on IP Office (analog, digital IP) but will work as audio devices only when calling these telephones. They can also receive audio calls from these telephones/lines.



- Video needs a high bandwidth in the network, depending on codec/Video quality it can be up to 1 Mbit/sec. Through planning of the capacity it has to be assured that there is sufficient bandwidth available for both audio and video. A network assessment is mandatory and has to take the bandwidth requirements into account. Please refer to the details of the product(s) to be used for exact Video requirements.
- All Video connections are "end to end". IP Office does not negotiate e.g. Video Codes; this will be done by the Video endpoints (via IP Office) only. The Video-capability is therefore depending on the used devices. It was confirmed that IP Office works with both H.263 as well as H.264 Codecs
- Video calls have limited functionality. While with most devices hold and transfer works, this is of course depended on the tested device. IP Office feature access codes are available for Video telephones and e.g. call forwarding will function with video devices. Forward to voice mail will work but will only record audio streams, no video calls.
- IP Office supports a single video call per session only. No dual Video channels for e.g. Video and sharing of applications are possible.
- A single endpoint can accept several video calls in parallel. That makes it possible to leverage "MCU" (Multi conference Unit) functionality in an endpoint like inside the Avaya 1040 system. It makes Video conferences between a device with MCU and several other endpoints possible.
- Typical bandwidth requirements for HD video:  
Video bandwidth needed per call (transmit and receive, Audio bandwidth not included) for e.g. the Avaya 1010/1040 Video Conferencing systems.
  - 1010: 1 Mbps for 720p/30fps
  - 1040:
    - 768 Kbps for 720p 30fps
    - 1.1 Mbps for 720p 60fps
    - 1.7 Mbps for 1080p 30fps

## IP Office 8.1 Interoperability

With IP Office Release 8.1, a number of interoperability scenarios with other Avaya products have been tested and will be supported going forward. The scenarios include:

1. IP Office 8.1 and Avaya Aura Communication Manager 6.2

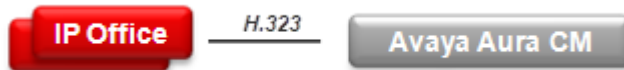

2. IP Office 8.1 and BCM 6.0

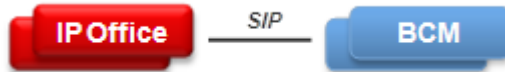

3. IP Office 8.1, BCM 6.0 and CS1000 7.5 with NRS

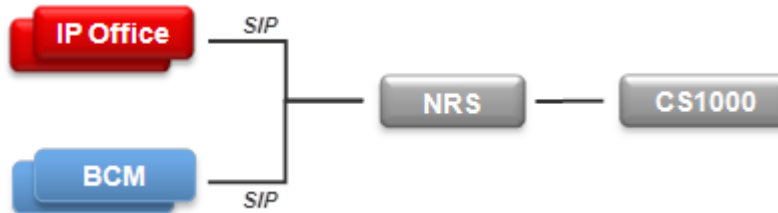

IP Office 8.1 has not been tested in any configuration involving Avaya Aura Session Manager (SM). Avaya recommends partners and customers who need a small to medium branch solution networked to an Avaya Aura Core, including Avaya Aura SM, to position the Avaya B5800 product. The B5800 is based on the IP Office platform but provides advanced SIP interoperability and functionality with the Avaya Aura Core product including Session Manager, Communication Manager, and legacy Nortel products such as BCM, CS1000, and Call Pilot.

## IP Office and Communication Manager Interoperability

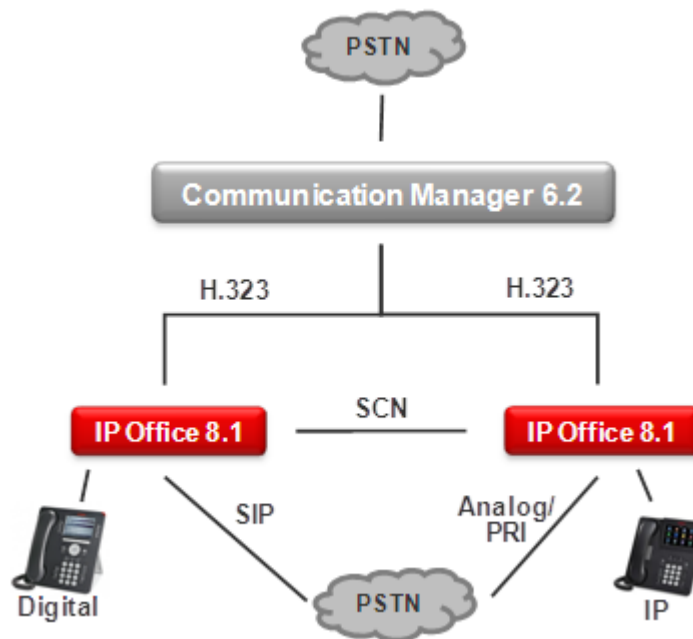

The H323 protocol is used for trunks between the IP Office nodes and the CM. The IP Offices are a network of SCNs and can use advanced SCN feature set between each other.

- **Protocol Support:**
  - IP Office to CM: H.323
  - IP Office to IP Office: H323 - SCN Networking
- **Platform Requirements:**
  - **IP Office:**
    - Release: IP Office 8.1

- Edition: Essential, Preferred, Advanced, and Server Edition
- **Communication Manager:**
  - Release: CM 6.2
- **Centralized Voicemail:** Centralized Voicemail for all IP Office systems in the SCN network
- **Phones:** All phones supported on the individual call servers and releases including Avaya IP Phone(H323), Avaya Digital phones, BCM 7000 Series Digital phones, BCM1100/1200 Series IP Phones (SIP), DECT R4 and Analog phones.

The advanced feature set of SCN Networking is available between the IP Office nodes.

## IP Office and BCM Interoperability

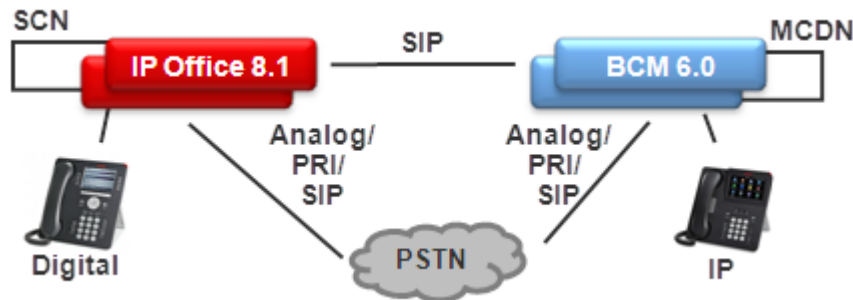

The SIP interoperability support between IP Office and BCM50/450 allows customers to migrate a network of BCM, step by step, to an IP Office SCN or Server Edition network.

- **Protocol Support:**
  - IP Office to BCM: SIP
  - BCM to BCM: SIP or SIP/MCDN
  - IP Office to IP Office : H323 – SCN or SIP
  - It is not possible to network IP Office and BCM via the MCDN or SCN protocol directly
- **Platform Requirements:**
  - **IP Office:**
    - Release: IP Office 8.1
    - Edition: Essential, Preferred, Advanced, and Server Edition
  - **BCM:**
    - Release: BCM50 and BCM450 6.0
- **Centralized Voicemail:**
  - The IP Office system may use a centralized Voicemail PRO system in the SCN network
  - The BCM systems may use a centralized voicemail within the BCM MCDN network.
  - Centralized Voicemail across IP Office and BCM systems is not supported.
- **Phones:** All phones supported on the individual call servers and releases including Avaya IP Phone(H323), Avaya Digital phones, BCM 7000 Series Digital phones, BCM1100/1200 Series IP Phones (SIP), DECT R4 and Analog phones.

The advanced feature set of IP Office SCN Networking is available between the IP Office and BCM. MCDN Networking features are also available between the IP Office and BCM. The standard SIP features described below are supported.

## IP Office, BCM, and CS1000 Interoperability

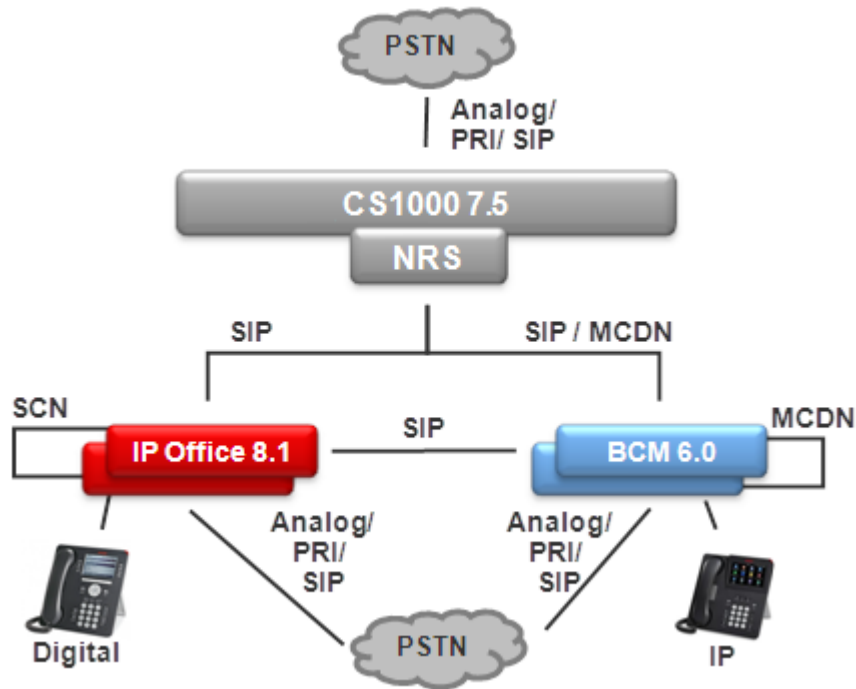

This configuration allows migrating a network of BCM and CS1000 to the IP Office step by step by adding IP Office systems to it.

- **Protocol Support:**

- IP Office to BCM: SIP
- IP Office to CS1000: SIP
- IP Office to IP Office: SIP or H323 - SCN Networking
- BCM to BCM: SIP or SIP/MCDN
- BCM to CS1000: SIP or SIP/MCDN
- Only UDP will be supported and not TCP

**Note:** IP Office to CS1000 using H.323 or PRI trunks is not supported.

- **Platform Requirements:**

- **IP Office:**
  - Release: IP Office 8.1
  - Edition: Essential, Preferred, Advanced and Server Edition
- **BCM:**
  - Release: BCM50 and BCM450 6.0
- **CS1000:**
  - Release: CS1000 7.5 with NRS
- **Centralized Voicemail:** Centralized Voicemail for all IP Office systems in the SCN network. BCM systems may use centralized voicemail of the CS1000. IP Office systems cannot use centralized voicemail of CS1000.
- **Phones:** All phones supported on the individual call servers and releases including Avaya IP Phone (H.323), Avaya Digital phones, BCM 7000 Series digital phones, BCM1100/1200 Series IP phones (SIP), DECT R4 phones, and Analog phones.

---

## SIP Standard Call Feature Support

The following call features are supported for the standard SIP Networking connections described above:

- **Standard Call Features:**

- Basic Call Completion
- Handling of busy called party
- DTMF and ring-back tone
- Hold and Retrieve
- Call Waiting presentation
- Called Number display
- Calling number and name display
- Abandoned call

- **Call Redirection:**

- Call Forward (Forward ALL, Forward Busy, Forward No Answer)
- Call Transfer (Attended and Unattended)
- Call Redirection (To PSTN, Abandoned, Busy)

- **Conferencing:**

- AdHoc and MeetMe conferencing

- **PSTN Toll Bypass:**

- Toll Bypass allows each system to leverage the trunk connections of the other system in the network to avoid international and long distance charges.

---

## Remote Phone Support

---

### Remote Working - NAT Traversal

The new Remote Worker feature allows the connection of remote 9600 Series IP Telephones with the H.323 FW which resides behind a NAT Router to IP Office Release 8.0 and later. The configuration does not require any VPN concentrator equipment with the IP Office system.

With the Remote Worker feature enabled, remote 9600 H.323 IP Phones can connect to the IP Office system even if the IP Office is located behind a NAT router. The sets are authenticated on the IP Office in the same way as sets in the private network. The IP Office will determine that a set is located outside the private network based and relay the VOIP RTP traffic to ensure it transverses the NAT router.

It is important to note that the H.323 signaling and the media traffic is not encrypted, but the proprietary binary format adds a basic level of encryption.

To reach the IP Office from the remote private network remote H.323 IP Phone needs to be configured to the public IP address of the NAT router hosting the IP Office. Configurable ports need to be forwarded to the IP Office. The IP Office requires a valid public IP address be configured for the feature to function. The public IP address can be statically configured or dynamically discovered via a STUN server.

The Remote Working feature needs to be enabled in the IP Office Manager. The Remote Worker feature requires the Essential Edition license which provides four (4) remote worker seats with the IP Office system. Additional remote worker capability is available with the Teleworker User package and a Preferred Edition license.

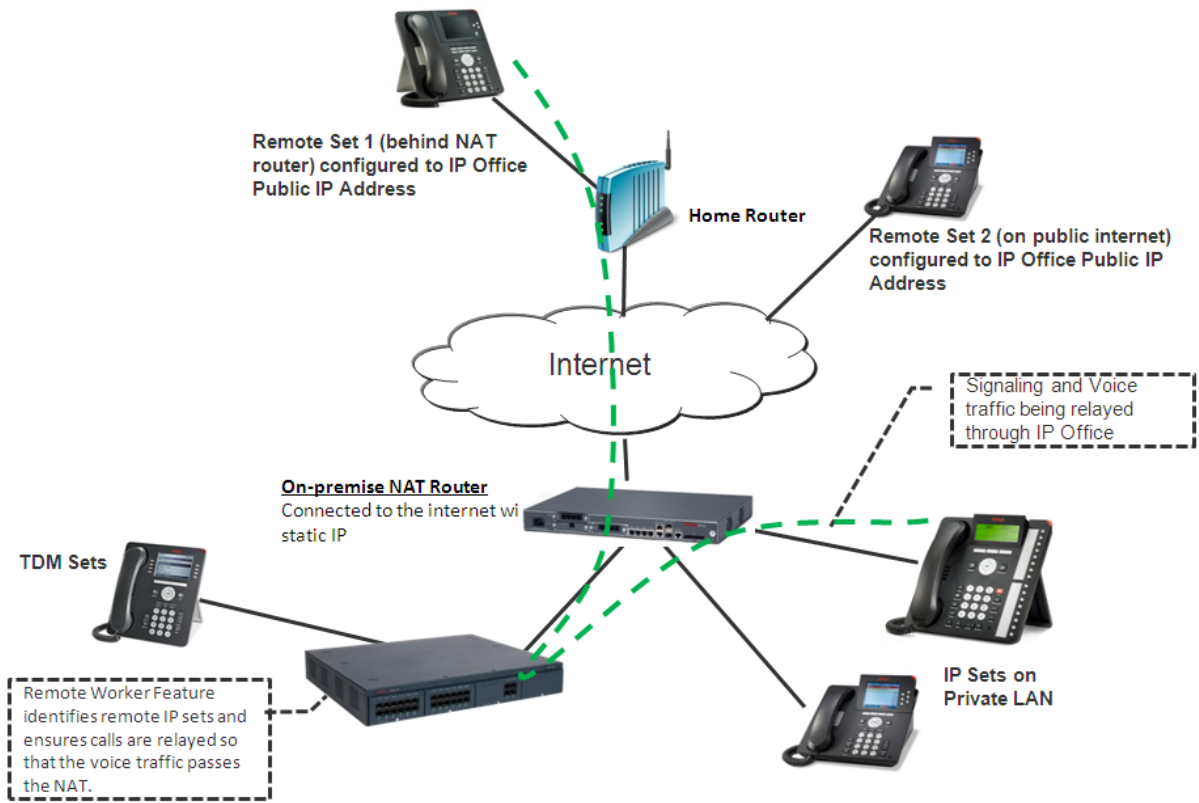

## VPN Phone Functionality

VPN Phone is a full-featured IP Telephony solution that provides secure communication over public ISP networks to an IP Office system at the company headquarters.

It is a software-only product that runs on the standard 5610/5620/5621 or 4610/21 IP telephones. In combination with one of these telephones and the most popular VPN gateway products, the software extends enterprise telephony to remote locations.

VPN functionality is supported on the new 9600 IP telephones, not requiring a separate software load.

VPN telephones offer the full IP Office telephony features that are available on IP Office IP telephones at the user's desktop in a remote location like a home-office:

There is no restriction on VPN phone usage.

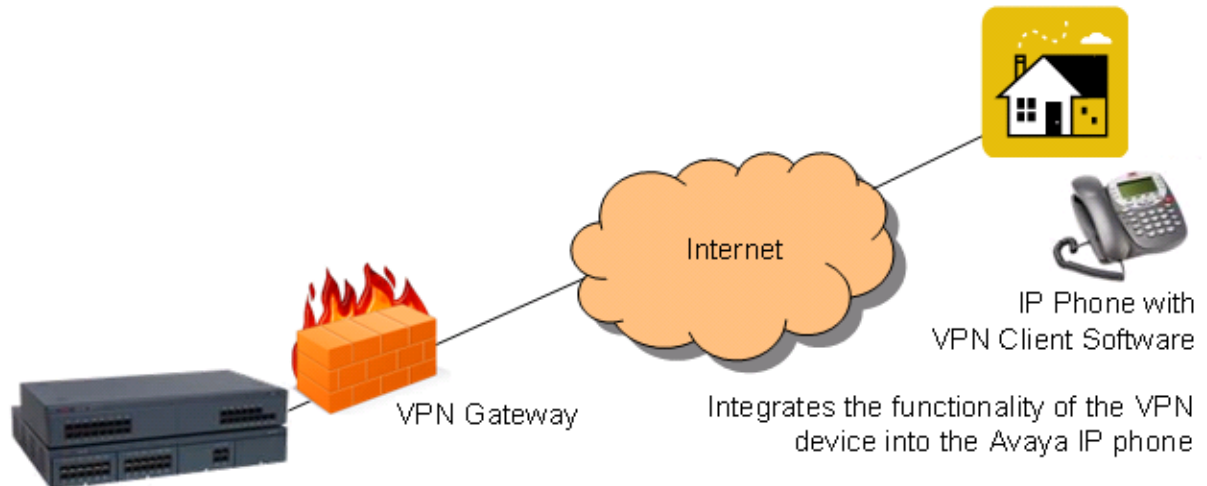

VPN Phone is ideal for IP Office customers supporting "work-at-home" users:

- Virtual Office workers
- Remote workers
- Remote call center
- Business continuity support
- Very small locations that require a single phone only
- Temporary installations such as conferences, off-site meetings, and trade shows

VPN Phone has been tested with a number of VPN-gateways from major vendors like Cisco or Juniper as well as with smaller VPN-access devices from companies like Adtran, Kentrox, Netgear, and SonicWall. Refer to the support pages ([support.avaya.com](http://support.avaya.com)) for a list of available application notes on VPN-gateways tested with each line of telephones.

---

# Avaya Session Border Controller for Enterprise

---

The Avaya Session Border Controller for Enterprise is a flexible, fit-for-purpose solution that includes a set of standard security features. This Session Border Control (SBC) provides all of the functionality required for Small-Medium enterprises to terminate SIP trunks without the complexity and higher price associated with typical SBCs. The Avaya SBCE scales up to 150 simultaneous sessions per Portwell server (2,000 with other server options) and is fully supported within Avaya IP Office Release 8.1.

## Enterprise-Class functionality at SME Pricing

- Blocks toll fraud
- Blocks DoS, DDos and Call Walking attacks
- GUI driven
- Scalable to largest IP Office environments
- A fraction of the overall solution cost

## Easily upgradable to the Avaya Session Border Controller for Advanced (for future releases)

- VPN-less SIP remote worker protection
- Enhanced Toll Fraud and DoS protection

The Avaya Session Border Controller for Enterprise will be included in the GSSCP reference architecture for IP Office, as a recommended option to complement the base reference architecture, where appropriate to the specific customer requirements.

For more information about Avaya's Session Border Controller for Enterprise, please navigate to the following URLs:

- <https://enterpriseportal.avaya.com/ptlWeb/gs/products/P0996> (Avaya SBCE)
- <https://enterpriseportal.avaya.com/ptlWeb/gs/products/P0997> (Avaya SBCE)

---

## VoIP FAQ

---

### Network Requirements

Quality of Service (QoS) is a measure of the performance of a network that reflects the availability of network service and the quality of network transmissions. The term itself refers to a number of networking technologies and techniques and does not necessarily restrict itself to any single protocol or standard.

There are a number of measures that can be taken on the LAN and WAN to make them 'good enough' to carry voice traffic. Some of these are the implementation of standards based QoS protocols while are simply a matter of network architecture and good network management practices.

The term 'good enough' is intentional. Every customer will have different expectations and different budgets to work to. Some will be willing to upgrade their networks to use the best possible equipment and practices. To others the additional expense may be viewed as unnecessary.

Examples of standards based Quality of Service protocols include DiffServ and 802.1p/q.

---

### What are Voice Compression Modules (VCM's) for?

VCM's are required to support the following scenarios:

- Internal phone calls between an IP device and a non-IP device.
- Analog/digital telephones to IP trunks (SIP/H.323) including managed Frame Relay and managed IP VPN (provides echo cancellation).
- IP telephones to ISDN or PSTN trunks (convert IP to TDM and vice-versa).

IP device to IP device

Call progress tones (for example dial tone, secondary dial tone, etc) do not require voice compression channels with the following exceptions:

- Short code confirmation, ARS camp on and account code entry tones require a voice compression channel.
- Devices using G.711, G.722, or G.723 require a voice compression channel for all tones except call waiting.



When a call is connected:

- If the IP devices use the same audio codec no voice compression channel is used.
- If the devices use differing audio codecs, a voice compression channel is required for each.

"Direct Media" is a VoIP concept that circumvents resources (TDM bus, Gateway) within the system and improves the voice quality. If two IP devices are connected on the same system, a direct LAN connection between them will be established once the call has been set up (as long as they use the same Codecs). Direct media is supported between Avaya IP telephones and SIP telephones.

It is possible for an IP device to be physically located at one site while being registered at a different site. In this case, even for VoIP across the WAN the VCM would not be used, as long as the two IP devices involved in a phone call are registered on the same system.

---

## Bandwidth Required For Each Voice Call?

The bandwidth used varies depending on the compression method chosen. IP Office supports standards listed below. These will occupy approximately 10K and 13K of bandwidth respectively.

Use the following chart to choose the most appropriate compression algorithm for your available bandwidth.

Audio Codec	RTP Voice Data Payload	Packets per Second	LAN (bps)	% Overhead LAN	WAN (bps)	% Overhead WAN	Algorithmic Delay (milli-seconds)
G.723.1 (6.3K)	24 Bytes	33.33	20,800	225%	9,867	54%	80
G.729a	20 Bytes	50	29,600	270%	13,200	65%	40
G.711 (64K)	160 Bytes	50	85,600	34%	69,200	8%	20
G.722 (64K)	160 Bytes	50	85,600	34%	69,200	8%	20

---

## Typical Bandwidth Required For Video Calls

This is for Video transmit only. To the Video part, the audio channel needs to be added.

- Video bandwidth needed per call (transmit and receive, Audio bandwidth not included) as sample for the Avaya 1010-1040 for HD-Video:
  - 1010/1020: 1 Mbps for 720p/30fps

Typical Bandwidth for standard Video quality, for example with IP Office Video Softphone.

Resolution	Pixels	Typical Net Video Bandwidth Requirement	
		H.263	H.264
Low	176 x 144 (QCIF)	64 kbps	45 kbps
Standard	320 x 200 (QVGA)	162 kbps	114 kbps
High	640 x 480 (VGA)	776 kbps	545 kbps

---

## Acceptable Delay?

End-to-end delay should be 150 milliseconds or below.

---

## How Many Simultaneous Calls Can I Get Down My Link?

The following chart illustrates the theoretical maximum number of simultaneous voice calls that can be delivered over a WAN for a given link speed. This does not take into account any bandwidth that may be required for data traffic between sites or the physical limit of VoIP calls for the specific version of IP Office in use.

The number of simultaneous voice calls can be in excess of the capabilities of the individual platform, where the calls transit the switch as data traffic. In this situation compression resources are not used but obviously must be catered for in the overall bandwidth provision.

Compression	G.723.1 (6.3K)	G.729a (8K)	G.711 (64K)
Algorithmic Delay (seconds)	0.08	0.04	0.02
Number of Calls			
- 64Kbps Link	6	4	0
- 128Kbps Link	12	9	1
- 256Kbps Link	25	19	3
- 512Kbps Link	51	38	7
- 1Mbps Link	103	77	14
- 2Mbps Link	207	155	29

---

## What is the Maximum Number of Simultaneous VoIP Calls

Each IP Office can be fitted with optional Voice Compression Modules (VCM) to support VoIP connections.

The IP500 V2 is capable of supporting two VCM 32/64 modules allowing up to 128 simultaneous calls. With combination cards, another 10 VCMs are provided per card. Up to two combination cards are supported with IP Office.

---

## Network Assessment

With IP Office, optimum network configurations can support VoIP with a perceived voice quality equivalent to that of the Public Switched Telephone Network (PSTN). However, not every network is able to take advantage of VoIP transmissions. It is important to distinguish between basic compliance with the minimal VoIP standards and validated support for QoS which is needed to run VoIP applications over a data network.

With the exception of standalone configurations where IP telephones connect directly connected to the ports on IP Office, Avaya now requires that all customers formally audit their networks for IP telephony readiness before attempting to install any VoIP application.

A network assessment should normally include:

- Physical inventory of all equipment inclusive of the current version of code, and configurations as needed.
- An accurate and complete network topology for all networked sites, inclusive of IP addressing and physical/logical connections.
- An evaluation of the network's topology to check that the design is both sound and reasonable.
- Measurement of packet loss, jitter and delay over the course of multiple days and measured on a per minute basis. A graphical representation of the data is the preferred output method.
- Examination of QoS/Class of Service (CoS) parameters in place in the network.
- Summary of findings and possible actions to correct problems.

The assessment should leave you confident that the implemented network will have the capacity for the foreseen data and voice traffic, and can support H.323, DHCP, TFTP, and jitter buffers in H.323 applications.

With this in mind, if you require support during or after an IP Office VoIP installation, a copy of your network assessment documentation will be requested by your support channel.

For more details about available tools, resources and services to enable you to audit your network for VoIP readiness, please contact your local Avaya representative.

---

## IP Packet Flow Control

While a high-performance switch forwards data packets at full wire speed to and from its ports simultaneously, there may be times when a switch port may not be able to accept packets at the rate it is receiving them.

For example, the switch port may be receiving packets from multiple ports at the same time, or the switch port may be receiving packets from a port operating at a faster speed. For instance, the sending port might be operating at 100 Mbps, while the receiving port operates at 10 Mbps; or the sending port might operate at 1000 Mbps, while the receiving port operates at 100 or 10 Mbps. If data packets arrive for a port that is saturated with other packets, the packets may overflow the port's buffer, resulting in dropped packets and lost data.

Flow control is a congestion-control mechanism that prevents data loss at congested ports. Flow control prevents packet loss by controlling the flow of data from the transmitting device to ensure that the receiving device can handle all of the incoming data.

IEEE 802.3 flow control is used on Avaya IP telephones operating in full-duplex mode. If the receiving device becomes congested, it sends a pause frame to the transmitting device. The pause frame instructs the transmitting device to stop sending packets for a specific period of time. The transmitting device waits the requested time before sending more data.

---

## VoIP Standards Supported

IP Office supports the following protocols and standards:

- H.323 V2 (1998), Packet-based multimedia communications systems.
- Q.931, ISDN user-network interface layer 3 specification for basic call control.
- H.225.0 (1998), Call signaling protocols and media stream packetization for packet-based multimedia communication systems.
- H.245 (1998), Control protocol for multimedia communication.
- Session Initiation Protocol.
- Audio CODECs:
  - G.711 A-Law/Mu-Law (64K).
  - G.723.1 MP-MLQ (6.3K).
  - G.722.
- Silence Suppression.
- Fax Relay (IP Office to IP Office Fax Transport over IP).
- T.38 Fax support (SIP trunks and SIP endpoints).
- Local End Echo Cancellation 25ms.
- Out of band DTMF.
- Jitter buffer, 5 frames of jitter buffer.
- Internet Standards/Specification (in addition to TCP/UDP/IP).
  - RFC 1889 – RTP/RTCP, Real Time and Real Time Control Protocol.
  - RFC 2507, 2508, 2509 – Header Compression.
  - RFC 2474 – DiffServ, Type of Service field configurable.
  - RFC 1990 - PPP Fragmentation.
  - RFC 1490 - Encapsulation for Frame Relay.
  - RFC 2686 - Multiclass Extensions to Multilink PPP.
  - RFC 3261 - Session Initiation Protocol (SIP).
  - RFC 3489 - STUN.

# **Chapter 9.**

# **Public and Private Voice**

# **Networks**

## 9. Public and Private Voice Networks

With Avaya IP Office you can be networked via T1, PRI and BRI ISDN, including VoIP on the company WAN. Networking maximizes the potential of your business office locations and remote workers - building the best possible foundation for your future growth. IP Office provides each location with a scalable (up to 384 extensions) telephony solution that supports voice networking, and offers:

- Uniform dialing plan, making it easy to call co-workers anywhere on the network and improve customer service
- Consistent user experience by sharing the same telephones and messaging interface as in headquarters
- A user-defined central directory that is automatically synchronized
- Automatic Route Selection to optimize routing and bandwidth management
- Centralized voicemail and/or the ability to network voicemail systems together

The benefits of networking:

- Leverage any existing investment in Avaya systems at other sites.
- Centralize services (e.g. operator, voicemail) as well as management and administration to reduce costs.
- Speed deployment of remote offices, respond quickly to market demands.
- Improve inter-site communication to simplify information exchange.

## Private Circuit Switched Voice Networking

Private voice networks are built using structured leased line circuits (E1 or T1) or by establishing permanently connected 'B' channels over ISDN circuits between IP Office systems. Each channel within the E1 or T1 interface can provide a single voice or 64K/56K data call. Where leased line circuits are used within a private networking scenario, these E1 or T1 interfaces are typically configured to use QSIG signaling between sites.

QSIG provides a level of voice feature transparency between PBXs and is the favored signaling standard within multiple vendor and international voice networks. The IP Office E1 or T1 module terminates a QSIG connection with a 120 ohm RJ45 interface.

IP Office supports the following QSIG services across this network:

- **Simple Telephony Call/Basic Call:** ETS300 171/172.
- **Circuit Switched Data Call/Basic Call:** ETS300 171/172.
- **Called/Calling Line ID Presentation:** ETS300 173.
- **Called/Calling Name Presentation:** (SS-CNIP, SS-CONP, SS-CNIR) ETS300 237/238.
- **Message Waiting:** (SS-MWI) EN301 260/255.
- **Transfer:** (SS-CT) ETS 300 260/261.

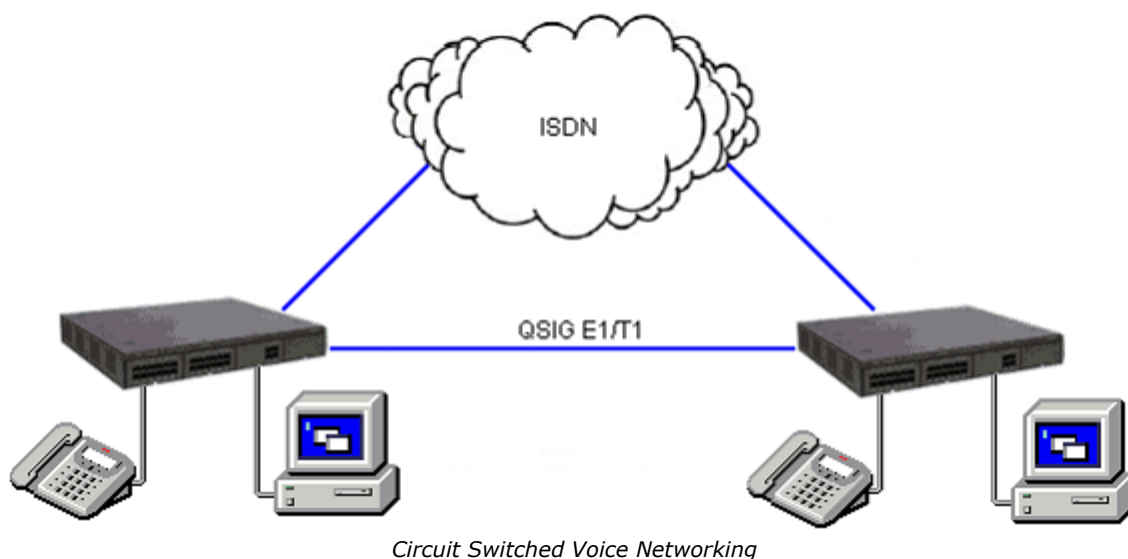

---

# Public Voice Networking

---

The IP Office platform supports a range of trunks and signaling modes for connection to the public switched telephone network (Central Office). Some of these lines are only available in certain territories; please check with your distributor for local availability. Primary rate trunks are available with either a single (24/30 channels) or dual trunk (48/60 channels).

## ISDN Primary Rate (ETSI CTR4)

Provided by the IP400 PRI E1 and IP500 Universal PRI cards.

ISDN Primary Rate provides 30 x 64K PCM speech channels over an E1 circuit and one signaling channel. Signaling Conforms to the ETSI Q.931 standard with Cyclic Redundancy error Checking (CRC).

The following supplementary services are supported:

- Calling Line Identification Presentation (CLIP) provides the telephone number of the incoming call to the IP Office.
- Calling Line Identification Restriction (CLIR) prevents the telephone number of the IP Office being presented on an outbound call.
- Connected Line Identification Restriction (COLR) Inhibits the COLP service.
- Direct Dialing In (DDI) where the exchange provides the last x digits of the dialed number on an incoming call. This allows IP Office to route the call to different users or services.
- Sub-addressing Allows the transmission/reception of up to 20 digits, additional to any DDI/DID or CLIP information, for call routing and identification purposes.

## ISDN Basic Rate (ETSI CTR3)

Provided by the IP400 Quad BRI and IP500 BRI cards.

ISDN Basic rate provides 2 x 64K PCM speech channels and one signaling channel using Q.931 signaling and CRC error checking. Both point to point and point to multipoint operation is supported. Multipoint lines allow multiple devices to share the same line; however point-to-point is the preferred mode.

Basic rate supports all the services that are supported on the primary rate version with the addition of

- Multiple Subscriber Number. This service is usually mutually exclusive with the DDI/DID service and provides up to 10 numbers for routing purposes, very similar to DDI/DID.

## Additional ISDN features

The following ISDN features are supported by IP Office 4.0 and later on both PRI and BRI trunks. Note that availability of these features is dependent on availability and support from the ISDN service provider, for which there may be charges.

- **Malicious Call Identification – MCID**  
(2400, 4600, 5400, 5600, T3, T3 IP, 9500, 9600)  
Short codes and button programming features are available so that users can trigger this activity at the ISDN exchange when required. This feature is NOT available on standard ISDN DSS1 telephones.
- **Advice of Charge – AOC**  
(T3 digital and IP telephones only; Phone Manager)  
Advice of charge during a call (AOC-D) and at the end of a call (AOC-E) is supported for outgoing ISDN calls other than QSIG. The call cost is displayable on T3 telephones for call accounting purposes. The IP Office allows configuration of call cost currency and a call cost mark-up for each user.
- **Call Completion to Busy Subscriber – CCBS**  
(2400, 4600, 5400, 5600, T3, T3 IP, 9500, 9600, DECT telephones; Phone Manager)  
CCBS can be used where provided by the ISDN service provider. It allows a callback to be set on external ISDN calls that return busy. It can also be used by incoming ISDN calls to a busy user. This feature is NOT available on standard ISDN DSS1 telephones.
- **Partial Rerouting – PR**  
(2400, 4600, 5400, 5600, T3, T3 IP, 9500, 9600, DECT telephones; Phone Manager)  
When forwarding a call on an ISDN channel to an external number using another ISDN channel, partial rerouting informs the ISDN exchange to perform the forward, thus freeing the channels to the IP Office. This feature is NOT available on standard ISDN DSS1 telephones and it is NOT supported on QSIG.
- **Explicit Call Transfer – ECT**  
(The normal usage of this feature is by a third party application)  
ECT is supported on the S0 interface. A Call to an S0 Endpoint can be transferred to any other device such as an analog, digital or IP endpoint or to any trunk. The normal usage of this feature is by a third party application connected via one or more S0 interfaces to IP Office. One example is the VoiceDirector, an automatic call assistant.

## North American T1

Provided by the IP400 PRI T1 and IP500 Universal PRI cards.

T1 Primary Rate provides up to 24 64K channels over a 1.54M circuit. Each channel of the T1 trunk can be independently configured (channelized) to support the following signaling emulations with handshake types of immediate, delay or wink.

- Loop-Start
- Ground-Start
- E&M Tie Line
- E&M DID
- E&M Switched 56K
- DID - Channels configured for DID/DDI support incoming calls only. The carrier or Central Office will provide the last x digits that were dialed to be used for call routing.
- Wink-Start

IP Office T1 trunks support both DNIS and ANI services, where available from the central office.

- Dialed Number Identification String (DNIS) Provides a string of digits to the IP Office depending on the number dialed by the incoming caller. This string can then be used to route callers to individual extensions, groups or services.
- Automatic Number Identification (ANI) Provides IP Office with a number identifying who the caller is. This may then be used for routing or computer telephony applications.

T1 trunk cards incorporate an integral CSU/DSU, eliminating the need for an external unit. The CSU function allows the trunk to be put in loop-back mode for testing purposes. This can be set manually, using the monitor application, or automatically from a Central Office sending a Line Loop Back (LLB) pattern. The DSU function allows the T1 trunk to be shared between data and voice services.

## North American Primary Rate Interface

Provided by the IP400 PRI T1 and IP500 Universal PRI cards.

IP Office supports Primary Rate ISDN trunks on 5ESS or DMS100 central office switches provided by AT&T, Sprint, WorldCom and other Local Telcos. Channels can be pre-configured for the supported services or negotiated on a call-by-call basis.

Special Services can be configured to route calls to local operators or pre-subscribed carriers for both national and international calls (SSS). Alternate carriers can also be selected through the configuration of IP Offices Transit Network Selection (TNS) tables.

IP Office also supports the Calling Name and Number service over Primary Rate Trunks (NI2).

## Analog Trunks

- **Loop Start**  
Loop start trunks are available on the IP Office Analog Trunk cards installed within the IP Office control unit, or on the Analog Trunk 16-port expansion modules (ATM16). The first two trunks on the ATM16 are automatically switched to power fail sockets in the event of power being interrupted. They conform to the TIA/EIA-646-B standard. The loop start trunks also support incoming caller line identification (ICLID) conforming to GR-188-CORE and GR-31-CORE standards. IP Office can use this information to route calls or provide it to computer applications to display additional information about the caller.
- **Ground Start**  
Ground Start trunks are only available on the ATM16, configured through IP Office Manager. The first two trunks on the module are automatically switched to power fail socket in the event of power being interrupted. They conform to ANSI T1.401 and TIA/EIA-646-B standards. Not available in all territories.



## E1R2 Channel Associated Signaling

Provided by the IP400 PRI E1R2 and IP500 Universal PRI cards.

The IP400 PRI E1R2 cards are available in two versions supporting either RJ45 or coax network connections. Each card provides channels that can be configured for MFC, Pulse or DTMF dialing dependent on the requirements of the network.

## Session Initiation Protocol (SIP)

IP Office supports SIP trunking. SIP trunks allow IP Office users to take advantage of new telephony services being offered by 'Internet Telephony Service Providers (ITSPs)'. In many cases, these telephony services can offer substantial savings in comparison to traditional exchange lines. The IP Office solution allows all users, regardless of their phone type, to make and receive SIP calls. SIP trunks are handled like any other line on IP Office, affording all the call routing and toll control needed to manage inbound and outbound calls.

SIP trunks on IP Office require the provisioning of voice compression channels through the installation of VCM modules within the control unit. A license for the maximum required number of simultaneous SIP calls is also needed. Up to 128 simultaneous calls are supported.

IP Office also supports the T38 protocol which allows Fax over IP.

There are several possible network topologies for SIP trunk systems, as shown in the following diagrams.

**Option 1:** Service provider with a Session Border Controller (SBC) - this is the preferred and recommended reference architecture for IP Office.

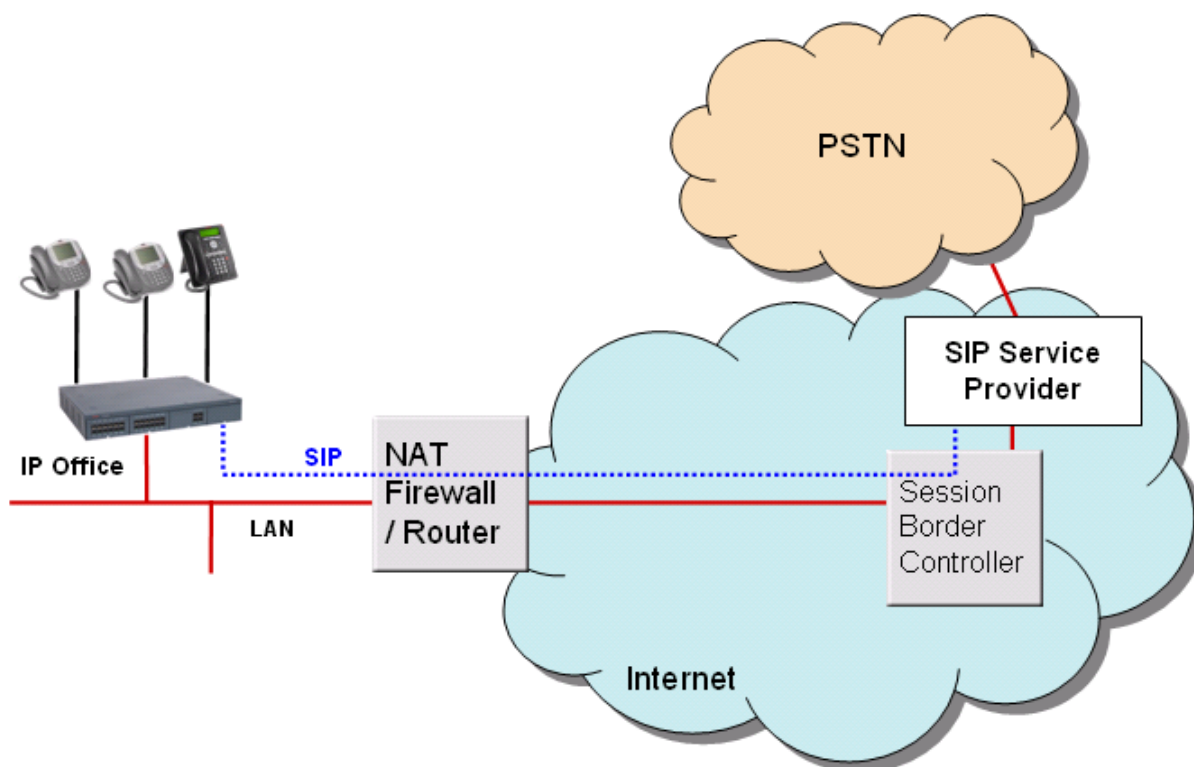

**Option 2:** Direct connection from the IP Office's second Ethernet port to the internet via a DMZ (demilitarized zone) port on the router. To make this configuration secure, the IP Office firewall is set to drop all packets except SIP.

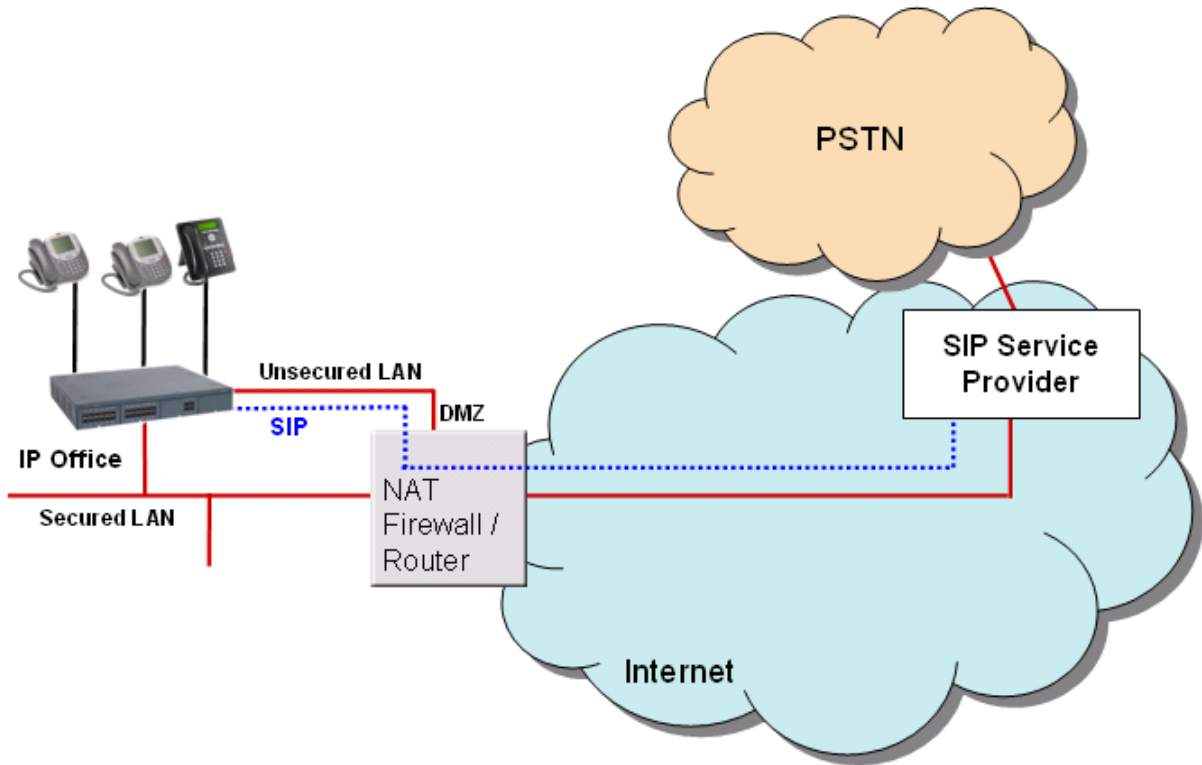

**Option 3:** Connection to the ITSP over NAT using 3<sup>rd</sup> party STUN (Simple Traversal of UDP through NAT) servers in the network to discover the NAT mechanism being used.

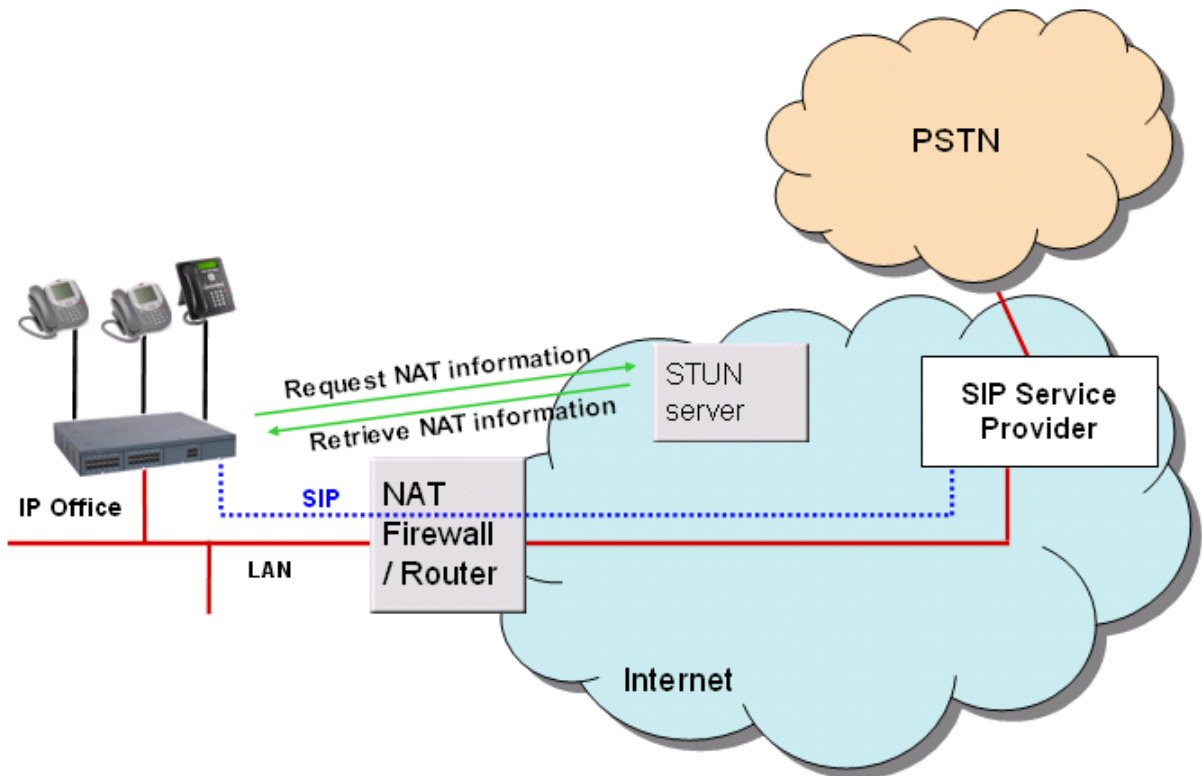

**Option 4:** Connection to the ITSP through a router equipped with an Application Level Gateway (ALG) which transparently resolves all NAT issues.

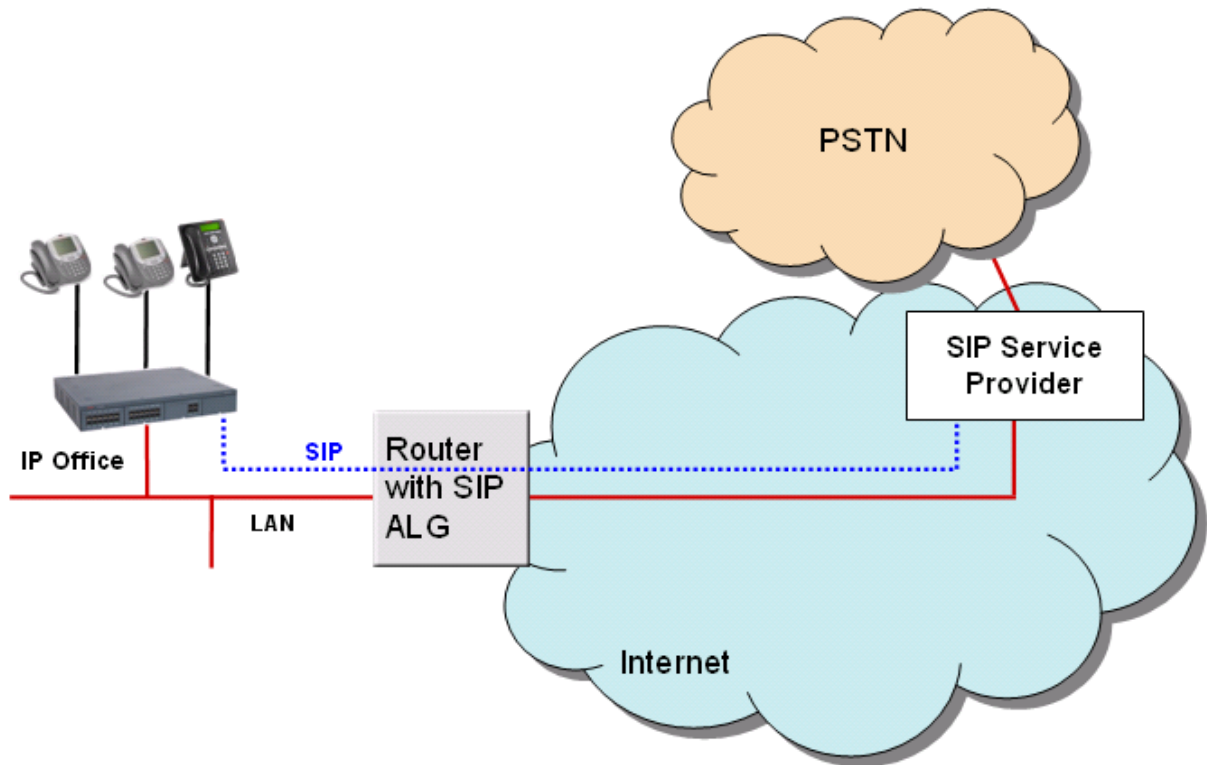

For details on SIP ITSPs which have been tested by Avaya, please visit the IP Office Knowledge Base at <http://www.avaya.com/ipoffice/knowledgebase>.

The Avaya DevConnect Program conducts testing with ITSP's to establish compatibility with IP Office. To access Application Notes for tested solutions please follow the steps outlined below:

1. Go to <http://www.avaya.com/devconnect>
2. Click on the "Tested Solutions Link" on the left-hand side of the screen.
3. Click the "Solution" tab.
4. Select "IP Office" under "Solution Platform". Select "Service provider - Platinum" and "Service provider - Gold" under the "Member Level"
5. Click the "Search" link at the bottom of the page.

## Packet Based Voice Networking

This section describes the options available for businesses that are able to utilize data networks to support voice solutions such as Voice over IP (VoIP). IP Office offers networked voice and data communications, providing:

- Built-in IP router
- One link for voice and data networking
- Common access to the Internet; share files and send e-mails to other sites
- Support for RIP-2 protocol for dynamic data routing; IPSec VPN, firewall and NAT (Network Address Translation) and for security; Centralized management and proactive fault management via SNMP.

IP Packet based voice networking between IP Office sites can be achieved through:

- VoIP across the campus LAN
- or VoIP across the public network.

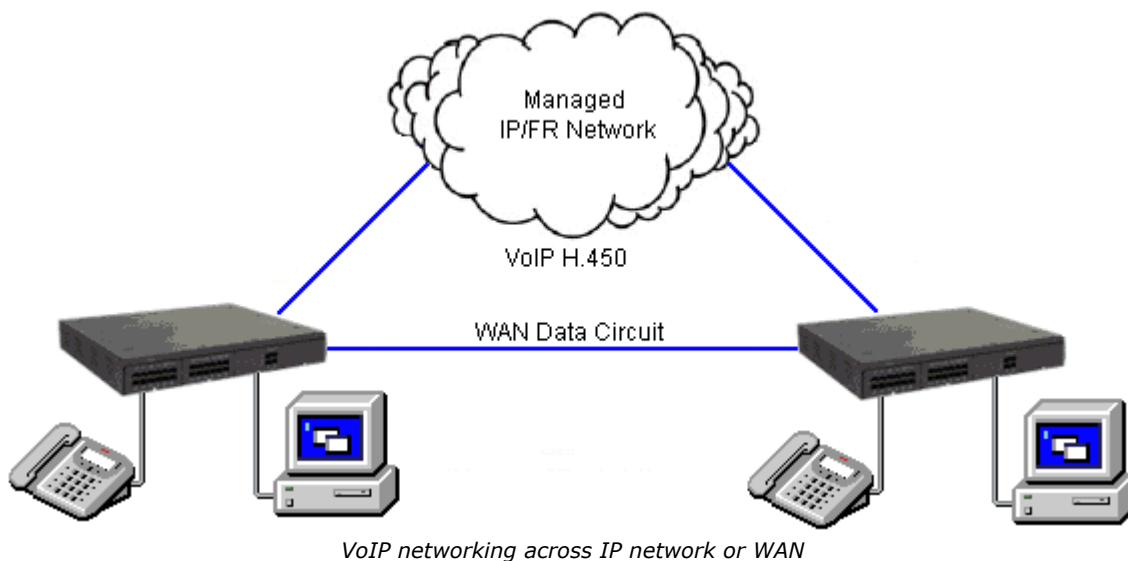

### VoIP across the LAN

In a factory or campus environment, voice calls can be sent over 10/100 Mbps LAN connections on systems equipped with optional Voice Compression Modules (VCM). IP Office supports Diffserve by appropriately marking both RTP packets and signalling packets to facilitate network bandwidth management.

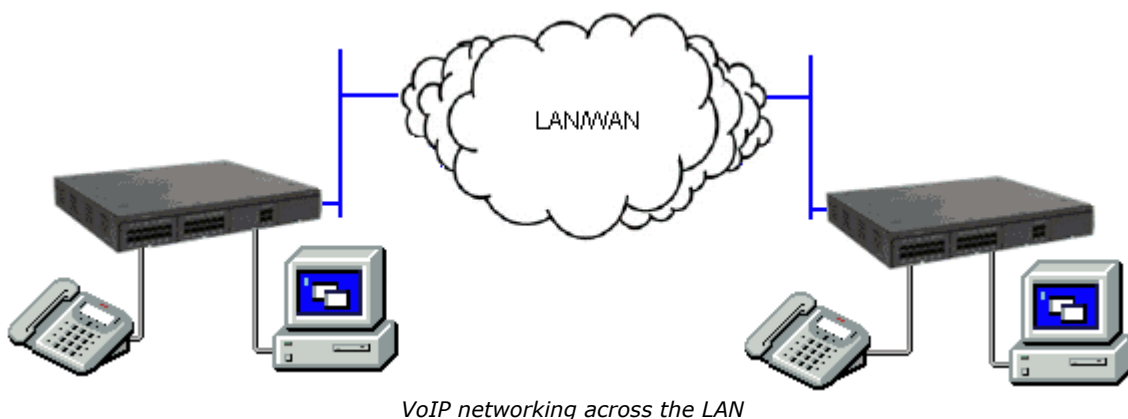

### VoIP across the Public Network

IP Office is capable of realizing the benefits of Q.931 and H.450 supplementary service support across a public connection where an appropriate QoS connection can be established.

---

## Supplementary Services within IP Networks

---

Supplementary services within an IP environment are provided over H.323 and SIP. IP Office provides the same rich services as enjoyed within a traditional network environment. Our standards based approach allows interoperability within mixed vendor networks.

The basic supplementary service features supported by H.323 and SIP on IP Office to IP Office IP trunk links are listed below.

- **Basic call set up (voice)**
- **Call Hold (local)**
- **Call Transfer (local)**
- **Called/Calling Name**
- **Called/Calling Number**

Additional features can be added through the use of IP Office Small Community Networking (see the following section).

On IP trunks to non-IP Office systems the Supplementary Service will depend on those also supported by the non-IP Office system.

---

## Multi-Site Networking (Small Community Networking)

---

When connecting IP Offices together over IP or Packet based networks, Small Community Networking enhances feature transparency. These networks can support up to a maximum of 1000 users across 32 sites. The following additional features are available.

- **Busy Lamp Field**
- **Camp-on**
- **Call Back When Free**
- **Paging**
- **Call Pick-up**
- **Centralized Personal Directory for 1400, 1600, 9600 and T3 Telephones as well as Avaya one-X™ Portal for IP Office**
- **Centralized System Directory for 1400, 1600, 9600 and T3 Telephones as well as Avaya one-X™ Portal for IP Office**
- **Centralized Call Log for 1400, 1600, 9600 and T3 Telephones as well as Avaya one-X™ Portal for IP Office**
- **Centralized Voicemail (Preferred Edition)**  
Support for mailboxes, call recording, dial by name and auto attendants. Remote queuing on remote systems is also supported.
- **Distributed/Backup Voice Messaging**
- **Internal Directory**
- **Absence Text Message**
- **Anti-Tromboning.**
- **Distributed Hunt Groups**  
Hunt groups can include users located on other IP Office systems within the network. Note that Distributed Hunt Groups are not supported for use with Customer Call Reporter.
- **Remote Hot Desking**  
Users can hot desk between IP Office systems within the network. The system on which the user configured is termed their 'home' IP Office; all other systems are 'remote' IP Offices. Note that Remote Hot Desking is not supported for use with CCC and CCR.
- **Breakout Dialing**  
This feature allows the user to select an IP Office system in the network from a displayed list and then dial a subsequent number as if dialing locally on the chosen system. This feature is triggered either by a programmable button or short code.

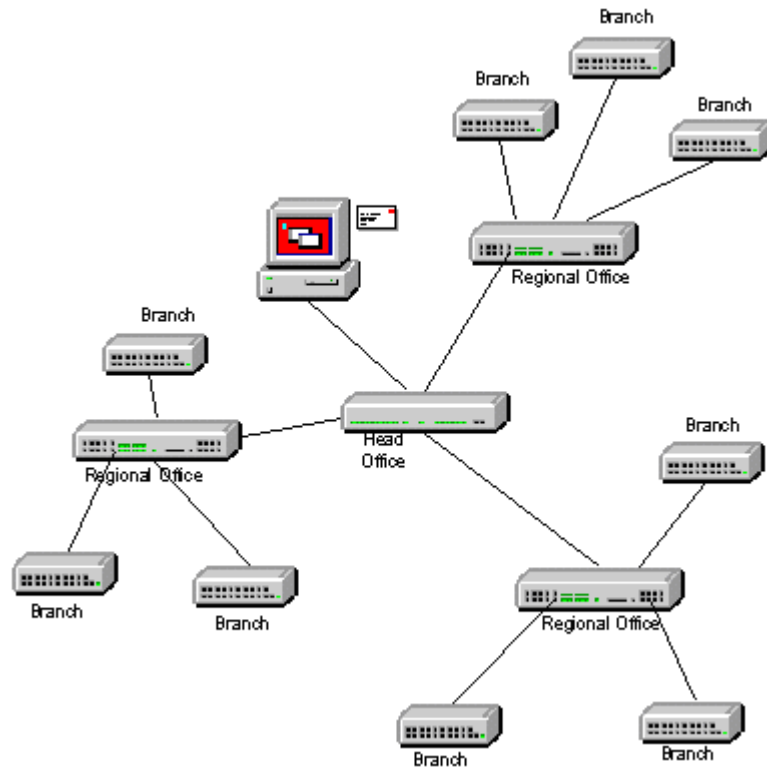

**Resilient Multi-Site Networking(SCN)**(see the diagram below)

In an SCN configuration of System "A" and System "B" where the centralized voicemail is connected to System B, and a number of IP telephones are connected to either System A or System B. If System "B" fails then:

- System A will automatically take over from System B and support Avaya IP telephones, hunt groups, and DHCP if required.
- Voicemail Pro will reregister to System A.
- For users in a Small Community Network (SCN), when they hot desk to another IP Office system, they retain their licensed profile setting as configured on their home system.
- All System B users' Personal contacts/Call Logs will continue to be available (1600 Telephones).

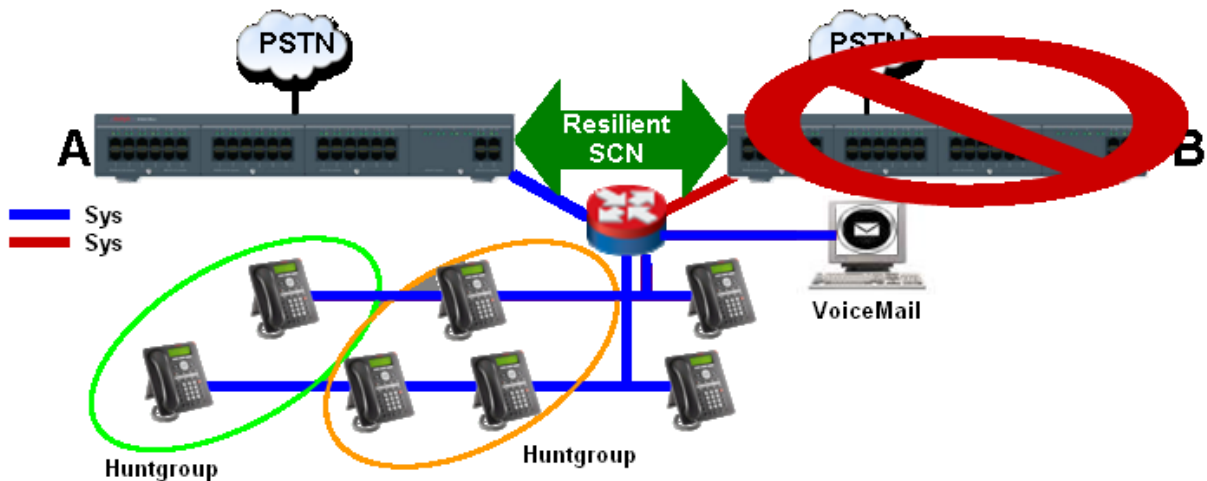

For Multi-Site Networks (SCN), VCM modules are required in all systems being connected. The IP lines may be configured in a star or a meshed configuration. One of the advantages of a meshed configuration is that it removes the risk of a single point of failure within the network. Also the names and numbers (groups, line, services, etc) on the separate IP Office systems should be unique to reduce potential maintenance confusion.

Each IP Office system broadcasts UDP messages on Port 50795. These broadcasts typically recur every 30 seconds but BLF updates are potentially more frequent. There are no updates if there is no activity and the overall level of traffic is very low – typically less than 1 kbps per system.

From IP Office Release 2.1(35) and higher, Multi-Site Networking is supported between IP Office systems with differing software levels but network features will be based on the lowest level of software within the network. This option is intended to allow the phased upgrading of sites within a Multi-Site network and it is still recommended that all systems within a network are upgraded to the same level where possible.

If larger networks are required QSIG can be used to link multiple Small Community Networks together. Functionality between the communities is governed by the QSIG feature set.

#### **IP500 Voice Networking License**

On IP500 and IP500 V2 systems, Multi-Site Networking (SCN) requires one or more additional licenses.

QSIG, H.323 and Multi-Site (SCN) capabilities are not enabled by default in the IP500 and IP500 V2. An additional license is required to enable this functionality with 4 simultaneous networking channels (no channel limit for QSIG). Additional channels can then be licensed in increments of 4. A Voice Networking license is still required to enable TDM QSIG, even though there is no limit to the number of TDM QSIG calls that can be made or received once licensed.



## Internetworking with Other Avaya Products

IP Office will support the most appropriate way for communication with any other existing PBX's in a customer network, whether TDM or IP-based. Some specific examples are provided below. Please refer to the following link to source the most current IP Office application notes: <http://portal.avaya.com/ptiWeb/products/P0160/ApplicationNotes>.

### VoIP networking using H.323

IP Office (since Release 1.1 in US and Release 1.2 in EMEA) has been successfully tested to be interoperable over IP trunks with Avaya Communication Manager (ACM). The protocol supported is H.323 using industry-standard compression codecs (types G.711A, G.711MU, G.729A and G.723.1-6K3). The features currently supported are:

- Desk to desk dialing (basic voice call)
- Calling/Connected Party ID number
- Calling/Connected Name Presentation
- Call Hold
- Call Transfer

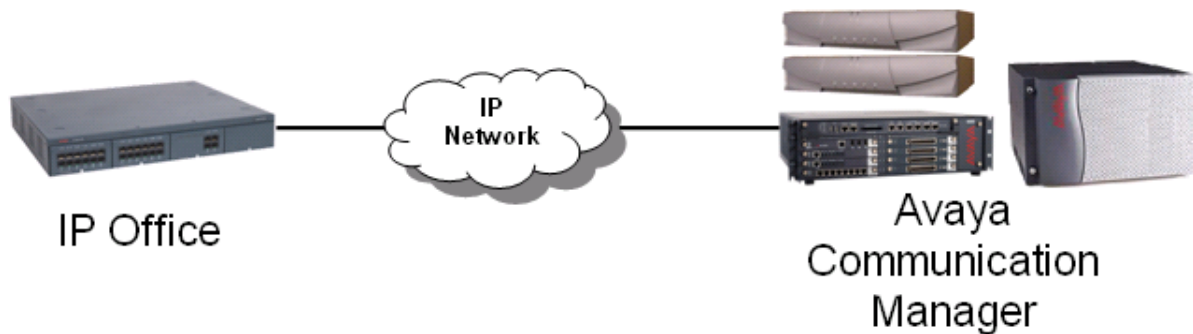

These features allow for simple networking needs between IP Office remote branches to a DEFINITY/ACM at the main site.

### QSIG networking using T1/E1 links (TDM)

Alternatively QSIG may be favored as the chosen signaling standard within multiple vendor environments and provides the following supplementary services which are also available between IP Office and DEFINITY / MultiVantage/ I55 /ACM (equipped with the relevant RFA licenses):

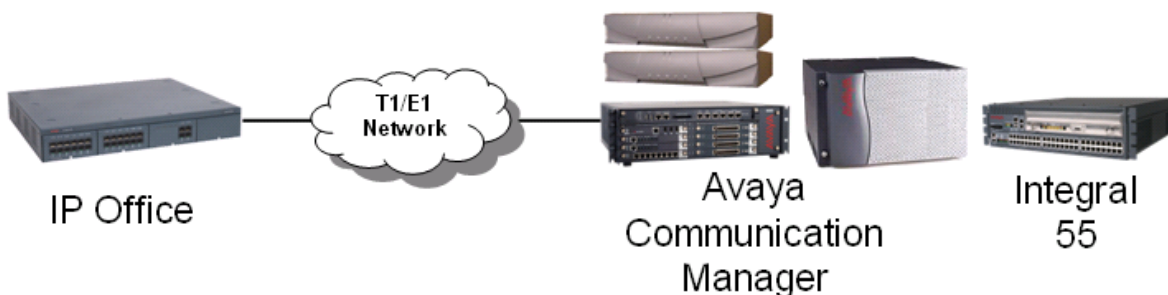

- Simple Telephony Call/Basic call (ETS 300 171/172)
- Circuit Switched Data Call/Basic call (ETS 300 171/172)
- Calling/Connected Line Identity Presentation (ETS 300 173)
- Calling/Connected Name Presentation (ETS 300 237/238)
- Message Waiting Indication (ETS 301 260/255)

---

# Common Networking Features

---

## Alternate Route Selection

Alternate Route Selection (ARS) allows calls to be routed via the optimum carrier. Time profiles can also be used to allow customers to take advantage of cheaper rates or better quality at specific times of day.

If a primary trunk is unavailable or congested, then ARS provides automatic fallback to an available trunk (e.g., analog trunk fallback if a T1 or SIP trunk fails, or use PSTN for SCN fallback).

Multiple carriers are supported. For example, local calls are to go through one carrier between specific hours and international calls through an alternative carrier. Carrier selection using 2-stage call set up via in-band DTMF is possible. It is possible to assign specific routes on a per user basis, e.g. only allow expensive routes to be used by critical staff.

Note: Existing Least Cost Routing (LCR) configurations are automatically converted to ARS when upgrading to 4.1 or higher.

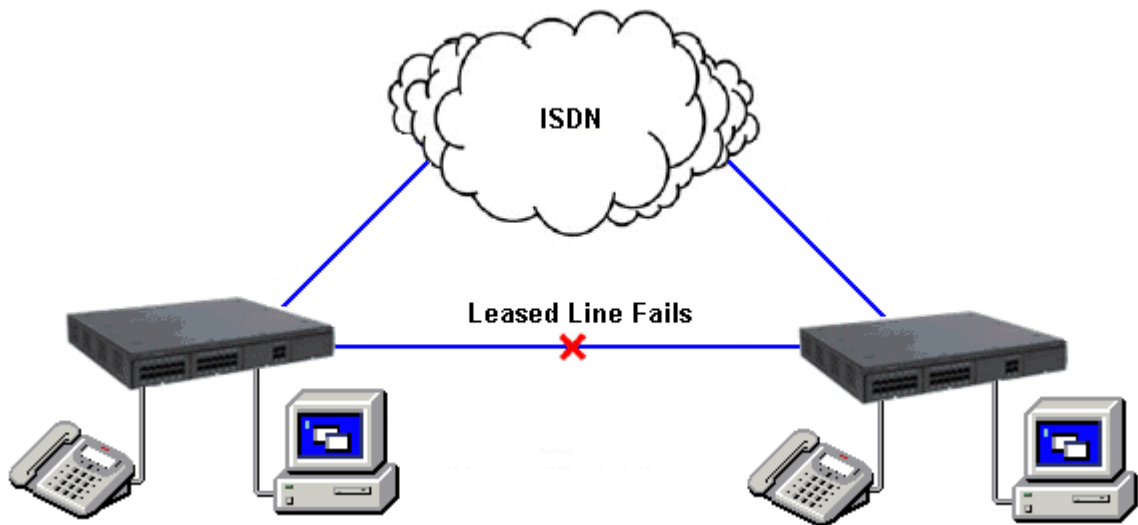

## Network Numbering Schemes

IP Office uses fully flexible network numbering options. Dialed digits can be manipulated to add or remove digits, access codes etc. in order to fit into any numbering scheme. Two types of numbering schemes are commonly deployed - 'Linked Numbering' and 'Node Numbering' schemes. In linked numbering schemes each site within the network has a unique range of extension numbers and users simply dial the extension number of the called party. Often, linked numbering schemes are used in very small networks (< 5 sites) with less than 500 extensions. With node numbering schemes each site is given a node ID and this is prefixed by the user when dialing extensions at other sites. In this way extension numbers can be replicated across sites while still appearing unique across the network. Node numbering schemes are common in larger networks. Linked numbering schemes and node numbering schemes are sometimes both used within the same network with node numbering used at the large offices and linked numbering employed at clusters of satellite offices.

The following figures depict these two types of numbering schemes.

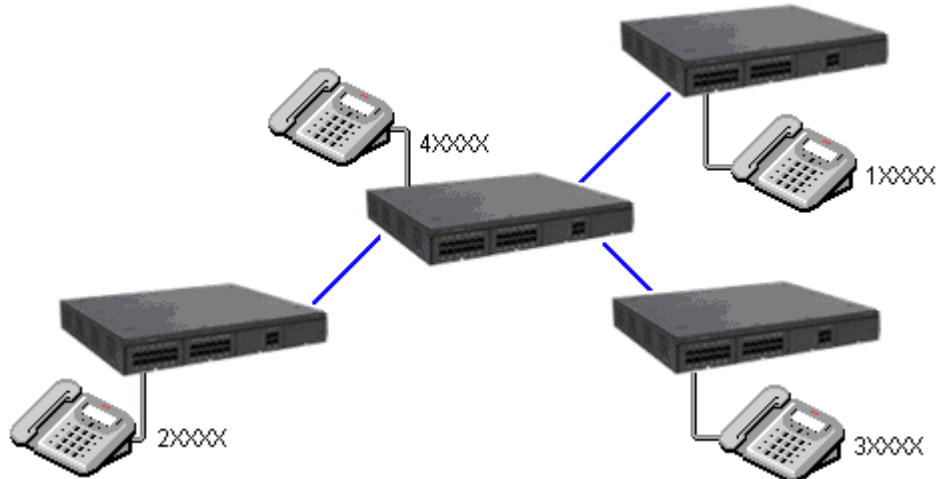

*Linked Numbering Scheme*

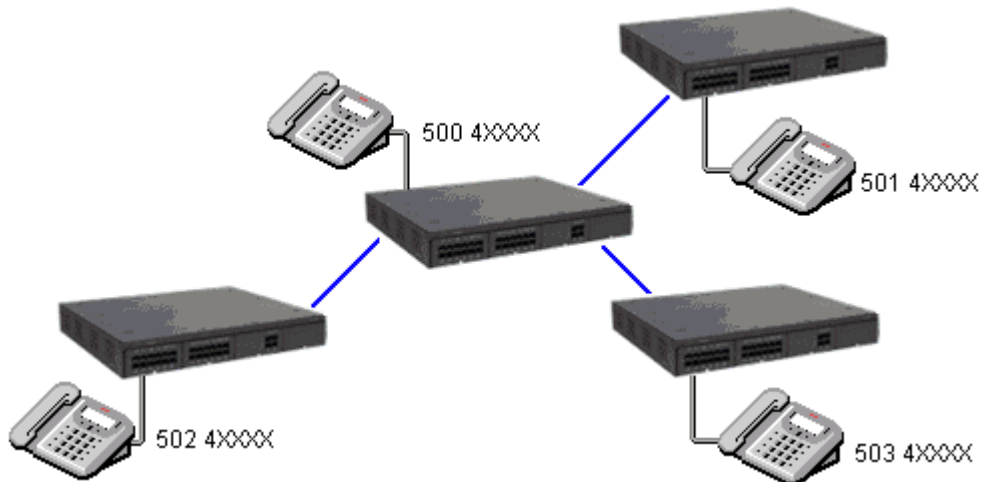

*Node Numbering Scheme*

# Chapter 10.

# Data Networking Services

# 10. Data Networking Services

## LAN/WAN Services

The IP500 V2 supports a firewalled 2 port Layer 3 Ethernet Switch.

When computers on the LAN communicate they do not care where the destination is, they just send messages with the address of the destination. These messages are likely to be received at all other computers on the same network but only one – the target destination – will act on the message. Where the destination is on another network, the router is needed to be the "gateway" to the rest of the world and find the optimum route to send the message on to the destination. The router alleviates the need to establish and hold a call for the duration of a communication session (when messages or IP packets are being sent between source and destination) by automatically establishing a connection only when data is to be passed. Routers may be connected together using WAN (Wide Area Network) links that could be point-to-point leased lines, managed IP networks, Frame Relay networks or exchange lines (Central Office). The IP Office system supports all of these types of network connections.

IP Office has an integral router with support for bandwidth on demand that allows the negotiation of extra bandwidth dynamically over time. Where connection is over ISDN, IP Office initiates extra data connections between sites only when there is data to be sent or sufficient data to warrant additional channels. It then drops the extra channels when they are no longer needed. The calls are made automatically, without the users being aware of when calls begin or end. The rules for making calls, how long to keep calls up etc, are configurable within IP Office.

It is possible to have several different routing destinations or paths active at any time linking the office to other offices and the Internet simultaneously.

## Internet Access

While the telephone is still the number one business communication tool, Internet access is becoming increasingly important for business-to-business communications. The ability to send and receive email, is now considered mandatory when dealing with many suppliers and customers, while access to the Internet for e-commerce applications and information has become vital.

IP Office systems provide shared, secure, high-speed access to the Internet via exchange lines (Central Office), digital leased line or IP VPN services.

Internet security concerns are addressed through the provision of an integrated firewall so removing the need for a standalone firewall. The firewall can be configured to cater for a variety of situations and will allow customers to control who can access external resources and when. The firewall isolates your private networks from the Internet, thereby ensuring that your network remains beyond the reach of hackers, while configurable service quotas can be set against a remote access service to ensure authorized users can gain access. Service Quotas place a time limit on outgoing calls to a particular IP Service so limiting costs. Each service can be configured with an alternative fall back, for example, you may wish to connect to your ISP during working hours and at other times take advantage of varying call charges from an alternative ISP. You could, therefore, set up one service to connect during peak times and another to act as fallback during the cheaper period.

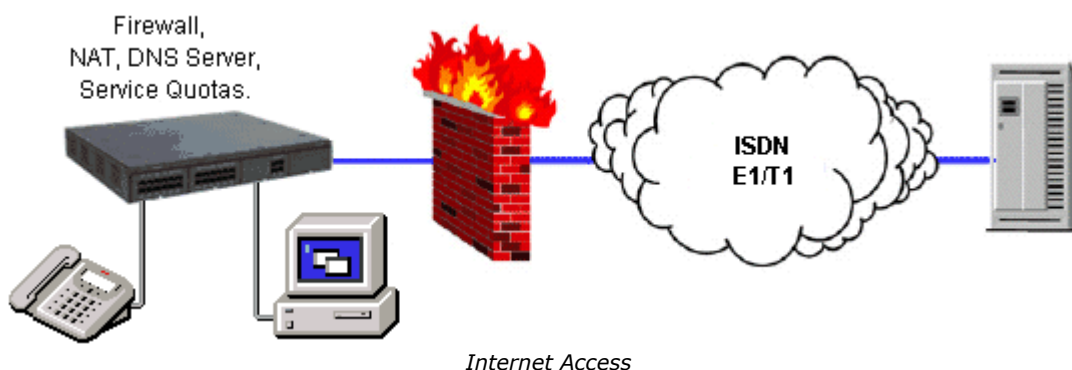

---

## Remote Access Features

---

IP Office's integral firewall, service quotas and timebands all apply to remote access calls. Remote access security can be supplemented by CHAP (encrypted passwords) to verify the end users, or PAP which does not support encryption. Timebands can control the hours within which the remote access service is available.

A "trusted location" can be set for dial in. These are locations that the System will allow either data access, e.g. a user dialing in from home, or access to voicemail without a voicemail code for a user collecting their voicemail messages from a mobile. The trusted location is also the location the Voicemail Server will call to inform the user of a new message.

Conversely a "specified location" can be set which restricts remote access from only that location, this specified location can also be a designated dial back number thereby minimizing the threat of unauthorized remote access.

IP Office systems can also incorporate remote access dial back services so that if a user always remotely accesses the office from a single location e.g. their home, then after login verification the system will disconnect their call and dial them back. In addition to the added level of security dial back provides it can also be an excellent method of consolidating remote access charges onto the central office telephone bill.

In addition to remote access from Telephone Adaptors, all ATM4 trunk cards (including the IP500 V2 Combination Card ATM) support switching of the first analog trunk to an integral V.32 modem for remote access.

---

## LAN to LAN Routing

---

All businesses now have a need for data routing whether it's a requirement to share resources such as email servers, file servers and internet gateways, or seamlessly transport data between sites or network to and from their customers and suppliers. This is why each IP Office platform offers IP routing as standard.

Embedding a router within IP Office removes the costs, complexity and additional points of failure of external WAN multiplexers by allowing data and voice traffic to converge and share the network resources of IP Office. These network resources can range from dial up ISDN connections, point-to-point leased circuits, managed IP networks or Frame Relay as IP Office supports all these types of network connections.

---

## SSL/VPN Remote Access

---

The IP Office SSL/VPN remote access solution is a fast and easy way to set up a secure remote access at broadband speeds. The solution is designed to provide Avaya and Avaya partners with reliable remote access that enhances service delivery while reducing the cost associated with truck rolls. The solution enables partners of any size to create an infrastructure that automates management and maintenance of IP Office systems.

### The IP Office SSL/VPN Solution

The IP Office SSL/VPN solution offers secure remote accessibility to the IP Office devices with minimum networking expertise required to set up the CPE at the customer site. The IP Office can be pre-configured with SSL/VPN configuration before installation at the customer's site.

---

## Advantages of the IP Office SSL/VPN Solution

- Secure remote access at broadband speeds for enhanced support
- Simple configuration and deployment
- Scaling to accommodate future growth requirements
- Networking expertise not required at the customer site (No IT admin required at the customer site)
- No requirement to open holes in the firewall (Firewall-agnostic as the connection is initiated from the customers' site to the Gateway)
- Connection can be "Always-ON" or can be initiated via Dial-Up or Phone.
- Facilitation of remote configuration, management, monitoring, diagnostics, and upgrades.

---

## Operation of SSL/VPN Remote Access

IP Office Release 8.1 software includes an embedded SSL/VPN client. On the server side (should the partner decide to host the server side), the partner will need to install a server (VM) and install the Avaya VPN Gateway (AVG) software. The Partner will establish the SSL/VPN Gateway configuration on the IP Office so that the IP Office can trigger a secure tunnel back to the Gateway.

A username/password is setup during the configuration step for security purposes. A second level of security is also provided with a server-side certificate authentication. A radius server will then validate the username/password upon connection request initiated from the IP Office. Once the credentials are validated, the secure remote access is established.

---

## System Requirements

At a minimum, the partner needs to ensure that a broadband connection is available at the customer site. A partner deciding to host the server side can purchase (scale as you go) the SSL/VPN licenses based on how many simultaneous connections are required. The AVG software is installed on a VM server software (the partner can choose the server of their choice) and set up a radius server for username/password authentication. The same VM server can also act as a radius server or the partner can use a separate radius server or reuse an existing radius server based on their IT department's recommendations and security policy.

Partners wanting to host the server side gateway should refer to the Avaya enterprise portal for more detailed information about the Avaya VPN gateway solution (see <https://enterpriseportal.avaya.com/ptlWeb/gs/products/P0623/AllCollateral>).

### Exceptions to the SSL/VPN solution described above:

- No support for IP Office 500v1 system
- No support for the Unified Communications Module or the external expansion applications server (Material Code – 269810) used with the IP Office
- When the partner hosts the server side, configuration of the solution is performed using IP Office Manager (as a result, the IP Office Basic Edition is not supported with the SSL/VPN solution)

---

## Data Networking Features

---

### Integral 10/100 Mbit Layer 3 Ethernet Switch

Layer 3 switching is particularly useful in situations where it is desirable to have a 'trusted' and 'unsecured' network, where the 'unsecured' network is uncontrolled and carries public traffic on it.

It is possible to set up a firewall between two LAN segments using the IP Office layer 3 switch. IP500 V2 supports a two-port Layer 3 Ethernet switch with the firewall between them. Both of these switched ports have their own IP addresses (LAN1 and LAN2) and in order for traffic to pass from one port to the other, a route is configured in the system's routing tables.

---

## DHCP Server

IP Office can manage your IP Network for you through its integral DHCP Server. IP Office can be configured to hold a pool of IP addresses for users on the Local Area Network. When a user powers up their PC, the system will allocate them an IP address for the duration of their session. The DHCP server also provides the user's PC with the address of the Domain Name Service (DNS) server and the Windows Name Service (WINS) server. Alternatively, for customers who have a separate DHCP Server, IP Office can be configured to obtain its address from that DHCP server or be set with its own static IP address. IP500 V2 has two independent DHCP servers, each one dedicated to Layer 3 switched LANs.

---

## Leased Line Support

IP Office is capable of connecting to leased line services.

IP Office WAN services are supported over E1/T1 PRI trunks and BRI trunks. E1/T1 trunks can be configured to operate in a fractional mode for 'point to multi-point' applications i.e. a single 2M interface could be treated as 3 x 512K and 8 x 64K going to 11 different locations. When using T1 as a Leased Line it is possible to use the same circuit for switched circuit services. Not all types of leased line are available in all territories, check for availability.

---

## Dial-Up Circuit Support

Where the amount of traffic does not justify the cost of a dedicated leased line, the system can provide data connectivity via ISDN dial-up circuits using its E1/T1 or Basic Rate trunks. Where data speeds greater than a single channel are required (64K/56K), additional channels can be added to the call as and when they are needed.

---

## Point-to-Point Protocol (PPP)

PPP is an industry standard Wide Area Networking Protocol, that allows inter-working with a wide range of 3<sup>rd</sup> party routers. PPP is used over leased line circuits where a single channel is used to connect the two locations together. e.g. A single channel maybe a 64K channel on a dial-up circuit or a 256K leased line etc.

---

## Multi-Link Point-to-Point Protocol (ML-PPP)

IP Office supports Multi-Link PPP allowing additional calls to be made where bandwidth greater than a single channel is required. The maximum number of channels available to data can be set on a service-by-service basis. When the available bandwidth reaches a user defined limit additional channels can be automatically added. Similarly, when traffic falls then the number of channels in use can be automatically reduced. If there is no data traffic on any of the channels in use then all lines can be cleared. Since most carriers have a minimum charge for calls, the period that a channel has to be idle before clearing is configurable. Through these mechanisms call costs can be effectively controlled while ensuring that bandwidth is available as and when it is needed.

---

## Frame Relay

Frame relay is a wide area networking protocol based on the X.25 protocol. Individual network connections are multiplexed over a common medium by the use of Permanent Virtual Circuits (PVC). This allows a single Leased Line to provide connectivity to a number of different locations. Frame relay is currently implemented in IP Office as a CPE or 'router end' protocol over WAN connections. IP Office supports both PPP and RFC1490 encapsulation with fragmentation of large data packets to provide voice quality of service.

---

## Service Quotas

IP Office can be configured to limit the maximum number of minutes that a service, such as Internet Access, is available for each user. This is the sum total of calls made and does not include periods of inactivity. Once the quota has been used the service is no longer available. The quota can be either automatically refreshed daily, weekly or monthly or manually refreshed by dialing a secure feature code on a handset.



---

## Time Profiles

Time profiles set the operational times for service. For example, a time profile could be set up to make Internet Access available to staff only during lunch times. Using time profiles it is also possible to define an alternative service to operate outside the operational hours of the main service. This may be used to take advantage of alternative tariffs at off peak periods. Switching to this fallback service can also be controlled manually by dialing a secure short code from a handset. This can be particularly useful in allowing quick restoration of service in the event of an ISP failure. This feature also applies to days of the week or specific calendar dates.

---

## Password Authentication Protocol (PAP)

PAP is a method of authenticating the remote end of a connection using unencrypted passwords.

---

## Challenge Handshake Authentication Protocol (CHAP)

Challenge Handshake Authentication Protocol allows an incoming data call to be authenticated using encrypted passwords. The system also provides the option to periodically reaffirm the authenticity of the caller during the data call.

---

## Data Header Compression

IP Header Compression (IPHC) reduces the header size of the data packet to gain bandwidth efficiency over Wide Area Networks, but adds to transmission latency.

---

## Data Compression

IP Office supports both Microsoft Point to Point Compression and Stac Lemple Ziv to provide greater throughput on slow speed wide area network links.

---

## Bandwidth Allocation Control Protocol (BACP)

Bandwidth Allocation Control Protocol allows the negotiation with the remote end of the data call to request additional calls to be made to improve aggregate data throughput.

---

## Callback

Three types of call back are supported

- **LCP (Link Control Protocol)**  
After authentication the incoming call is dropped and an outgoing call is made to a predefined number to re-establish the link.
- **Callback CP (Microsoft's Callback Control Protocol)**  
After authentication from both ends, the incoming call is dropped and an outgoing call to a predefined number made to re-establish the link.
- **Extended CBCP (Extended Callback Control Protocol)**  
Similar to Callback CP however, the Microsoft application at the remote end will prompt for a telephone number. An outgoing call will then be made to that number to re-establish the link.

---

## Domain Name Service (DNS) Proxy

Domain Name Service servers provide the translation of names such as www.avaya.com to the domain's IP address required to establish a connection. IP Office provides this service to PCs on the network by proxy.

---

## Network Address Translation (NAT)

Network Address Translation is a mechanism that allows you to use different IP address on your private network behind a router with a public IP Address. When connecting to the Internet, ISPs typically want a customer to use an IP address they have allocated. Using NAT this is easily accommodated, eradicating the need for the customer to change their network numbering scheme and providing additional security to the internal users as their address is hidden to the public.

Typically, a company maps its internal network addresses to a global external IP address and unmaps the global IP address on incoming packets back into internal IP addresses. This helps ensure security since each outgoing or incoming request must go through a translation process. This also offers the opportunity to qualify or authenticate the request or match it to a previous request. NAT also conserves the number of global IP addresses that a company needs.

---

## Proxy Address Resolution Protocol (ARP)

Support for Proxy Address Resolution Protocol allows IP Office to respond on behalf of the IP address of a device connected to it when receiving an ARP request.

---

## Auto Connect

If a service is idle, that is no one is using the Internet, Auto Connect allows the IP Office to periodically connect to a service. This is ideal for mail polling to retrieve email from an Internet Service Provider. An 'Auto Connect Time Profile' controls the time period during which automatic calls are made, for example not at weekends or during the middle of the night.

---

## Firewall

IP Office integrated firewall provides packet filtering of the most common IP protocols including File Transfer Protocol (FTP) and Internet browsing (HTTP). Each protocol passing through the firewall can be restricted/allowed access in four different ways:

- **Drop**  
No sessions via this protocol will be allowed through the wall
- **In**  
An incoming session can "punch a hole" in the wall to allow traffic in both directions
- **Out**  
An outgoing session can "punch a hole" in the wall to allow traffic in both directions
- **Bothway**  
An incoming or outgoing sessions can "punch a hole" in the wall to allow traffic in both directions.

In cases where a protocol is not supported by default, the firewall can be customized to control packets based on their content.

IP Office allows the configuration of as many firewalls as needed through IP Office Manager. This permits different security regulations to be applied to individual dial-in users and data services.

---

## Light-Weight Directory Access Protocol (LDAP)

IP Office supports LDAP directory synchronization. This allows the telephone number Directory (names and telephone numbers) held in IP Office to be synchronized with the information on an LDAP server (limited to 5000 entries). Although targeted for interoperation with 'Windows 2000 Server Active Directory', the feature is sufficiently configurable to interoperate with any server that supports LDAP version 2 or higher.

---

## Remote Access Server (RAS)

IP Office provides RAS functionality allowing external users to dial in to the local area network from modems, telephone adaptors and routers. Several of the previously described features and services can be applied to the dial-in users to create a powerful Remote Access Server. Dial-in users can be authenticated using either PAP or CHAP. Once authenticated the DHCP server can automatically assign the user an IP address to use while connected to the LAN. Individual time profiles and firewalls can be applied to the user restricting what they have access to and when they have access. For further security and accounting ease, IP Office can automatically call a user back. This keeps the cost of the telephone call on the company telephone bill removing the need to process individual expense claims.

---

## Routing Information Protocol (RIP)

RIP is a distance vector protocol that allows routers to determine the shortest route to a destination network. It does this by measuring the number of intermediary routers that need to be traversed to reach the destination network. If more than one route exists to the same destination the shortest route is used. If a fault occurs on the shortest route it will be remarked as being infinite and any alternative route will become the new shortest route. This behavior can be used to add resilience into a data network. Where a customer has an existing data

network comprising of third party routers, IP Office added to the network can provide back up using its routing and dial-up capability. RIP enabled routers share their knowledge of the network with each other by advertising and listening to routing table changes. IP Office Supports both the RIP I and RIP II standards.

## VPN: IPSec Tunneling

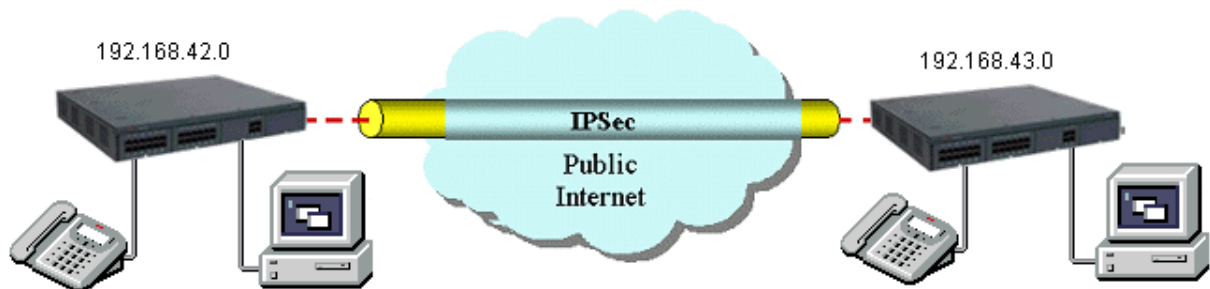

IPSec tunnels allow a company to pass data between locations over unsecured IP networks such as the public internet. The company data is secured using 3DES encryption making it unintelligible to other parties that might be 'eaves dropping' on the traffic. Tunneling can be applied to link offices together or provide workers access to the office over the internet. All IP Office systems support up to a total of 256K worth of encrypted traffic to multiple locations. Initially, inter-working is supported only between IP Offices that are connected either directly on a WAN port or via the LAN using a 3<sup>rd</sup> Party router. IPSec is optional and enabled on IP Office through a License Key.

Note: Check with Avaya for supported scenarios and 3<sup>rd</sup> party devices.

## VPN: Layer 2 Tunneling Protocol

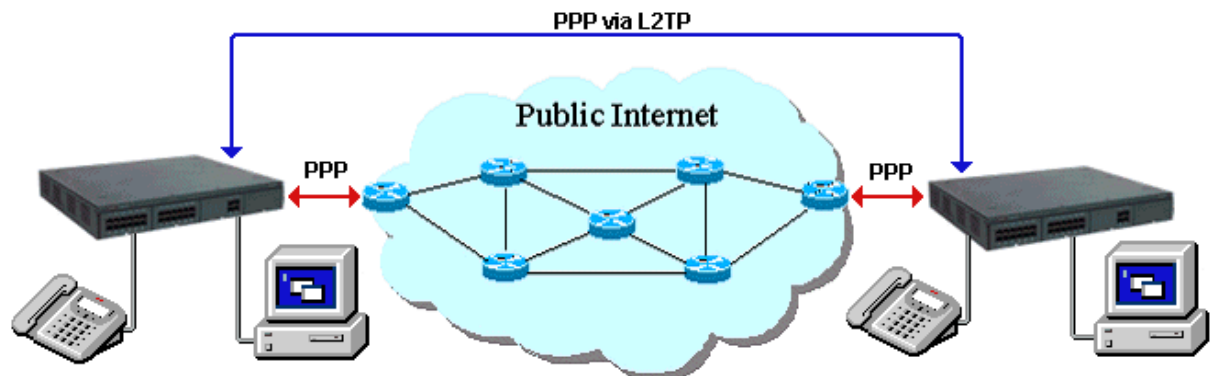

PPP authentication using PAP or CHAP takes place between directly connected routers only. When using a public IP Network to connect sites this authentication takes place between the customer's router and the service provider router that it is connected to. In some circumstances it is desirable to authenticate between the customer owned routers, jumping over all the intermediary routers of the service provider's network. Layer 2 Tunneling Protocol allow this to happen by facilitating a two stage authentication, firstly with the service provider router then the customer router on the remote network.

# **Chapter 11.**

# **Unified Communications**

# **Module**

# 11. Unified Communications Module

With the Avaya IP Office Unified Communications Module (UC Module, material code: 700501442), Avaya provides a single touch point for sourcing, maintenance and support of application deployment. The UC Module is an integrated CPU running Linux, thus avoiding the need for server licenses (Microsoft) and any requirement to keep an external server updated outside of the telephony software and hardware. Additional benefits include flexibility with application deployment such as Preferred Edition and the ability to expand ports, user licenses for user productivity packages.

In IP Office Release 8.0, the UC Module will come preloaded with all Preferred Edition Voice Mail Pro server software images including a Preferred Edition license, one-X Portal software images and IM/Mobility (same as the Linux Applications DVD for external servers).

The UC Module will include an implicit Preferred Edition license so all server software will be available depending on the User package purchased, e.g., Power User, Teleworker, Officeworker and Mobileworker Preferred. The Preferred Edition system license will come 'bundled' with the module. A pre-requisite Essential Edition system license is required for proper UC Module operation.

The UC Module integrates with existing IP500 V2 Control Unit:

- One (1) module per chassis
- SW loaded on UC Module on SSD card or via Ethernet from [support.avaya.com](http://support.avaya.com)
- one-X Portal for IP Office User Packages are supported. User Packages and Mobility will require user package licenses. The UC module will support up to 50 User Packages.
- Preferred Edition will be offered with the module in a bundled offer, with four (4) voicemail ports by default. Up to 20 voicemail ports are supported running concurrently with up to 50 User packages. 200 mailboxes/phones on a system or in a small community network are supported.
- Up to 40 voice mail ports when running just Voicemail Pro; with no User packages running on the system
- TTS, MAPI Email and UMS Exchange Integration are supported
- Supports systems running IP Office Advanced Edition mode (CCR) on Microsoft server
- Supports centralized Voice Mail Pro configuration up to six (6) sites; rules for maximum voice mail channels, User packages and mailboxes/phones must be maintained per UC Module
- Must be running IP Office R8.0 Q1 service pack or higher

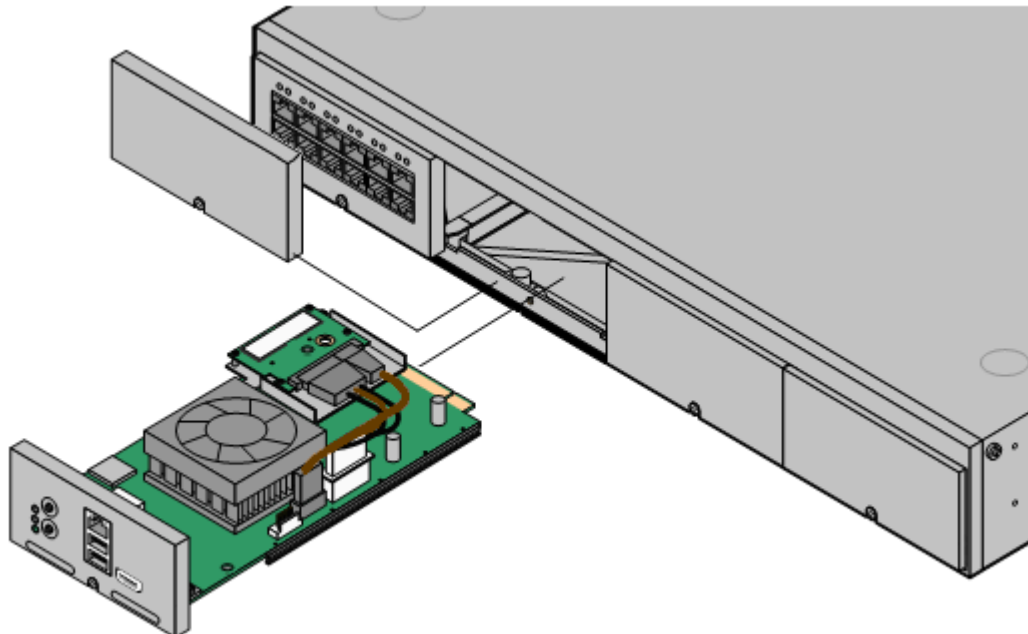

**System Platforms supported:** IP Office IP500 V2. Not applicable to IP Office for Linux.

The following will not be supported by the UC Module with the 8.0 Release:

- Advanced Edition natively on the card since Advanced Edition is Microsoft based
- VB Scripting

- 3rd Party Database Integration
- Web Voicemail
- Web Campaign
- VRLA Authentication: Contact Store can talk to Preferred Edition system running on Linux, but manual steps must be taken to properly setup the Linux system with shared folders
- VPNM

**Specifications:**

- Intel ATOM Processor Z680( 1.6GHz CPU)
- 2GB DDR
- 32 GB SSD Flash memory; ~380 hours of voicemail storage, accounting for logging which will use storage

# **Chapter 12.**

# **User Call Control**

# **Applications**

# 12. User Call Control Applications

Avaya provides the following call control applications with IP Office Release 8.0:

- [Avaya one-X™ Portal for IP Office](#)<sup>[304]</sup>  
Avaya one-X™ Portal for IP Office is a server-based application that the user accesses with their web browser. It can only be purchased as part of the IP Office Office Worker, Power User and Teleworker user licenses.
- [IP Office Video Softphone](#)<sup>[318]</sup>  
The IP Office Video Softphone is a full feature telephony client that supports standard telephony features as well as video conferencing on a PC running a Microsoft or Mac operating system.
- [Flare Communicator](#)<sup>[325]</sup>  
Avaya Flare Communicator is a collaboration software client that delivers an innovative interface for real time communications for Windows and on the iPad. It enables users to handle phone calls, instant messages, presence, enterprise contacts and launch e-mail, all from the same interface.

## one-X Portal for IP Office

The Avaya one-X™ Portal for IP Office is an application that provides users control of their telephone from a networked PC.

Avaya one-X™ Portal for IP Office can be used with any IP Office extension; analog, digital or any IP telephones, wired or wireless, and is available as part of the IP Office Office Worker, Power User or Teleworker user licenses only.

Avaya one-X™ Portal for IP Office is a server based application that the user accesses via web browser.

Via separate gadgets, Avaya one-X™ Portal for IP Office provides easy access to telephony features, call information, call and conference control, presence and instant messaging, directory and Voicemail Pro mailbox.

Office | one-X Portal for IP Office | Extn-401(401) | Available | Help | Logout | AVAYA

Main | Configure

### Calls

Enter name or number

Call Consult Transfer

1 2 3 4

1550

00:00:14

Extn402

1550

### Directory

Personal System External Search All

All Sales Team + Add group

Enter a name

Alfred

Brad

Ethel

Call mobile - 1550

Call other - 402

Page 1 of 1 | Displaying 1 to 3 of 3

### Messages (2 new)

Phone Enter name or number

State	From	Time	Length
✉	301 (301)	15-Mar 12:15pm	0s
✉	311	05-Feb 02:41pm	13s
✉	311	05-Feb 02:23pm	8s
✉	311	22-Jan 12:30pm	8s
✉	313	21-Jan 07:10pm	11s

Save Delete

### Call Log

All Incoming Outgoing Missed

Type	From	Time	Length	Calls
↓	Extn203 (203)	28-Jun 2:49:08 PM	0s	2
↓	Extn203 (203)	28-Jun 2:49:18 PM	0s	1
↓	Extn201 (201)	06-Jul 3:41:49 PM	8s	1
↓	Extn402 (402)	06-Jul 8:48:33 PM	8m	1

Clear Log

World Clock

Agent Control

one-X Applications | World Clock | Agent Control | Appearance



## Calls Gadget

### Caller ID/Name Presentation

Caller ID is presented as standard (where provided) allowing users to see who's calling before answering. The caller's phone number and name (if known to IP Office) are clearly shown in the call status area.

The same information is also displayed should a second incoming call be presented, allowing users to easily switch between calls.

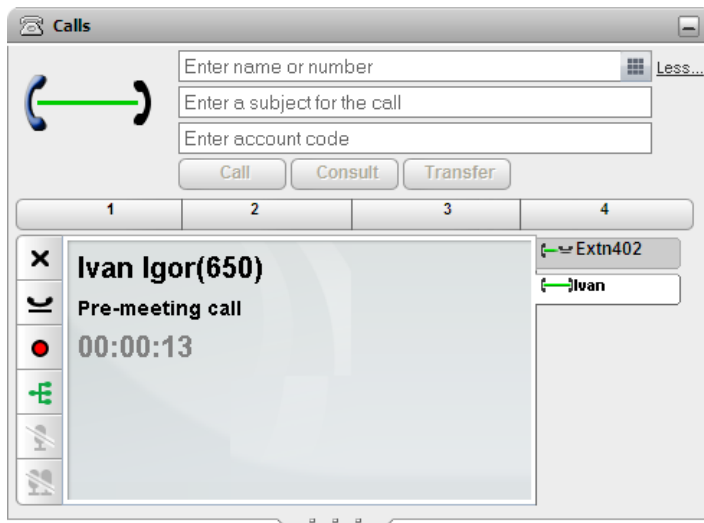

### Desktop PC Telephony Controls

Avaya one-X™ Portal for IP Office has telephony buttons in the call gadget that activate standard telephone functions such as Answer, Drop, Hold, Retrieve, Record, Mute, Consult and Transfer so that users don't need to remember IP Office specific feature codes. These functions are context sensitive and appear depending on the status of the call. Keyboard shortcuts are available for Answer, Hold, Drop and Call functions and can be configured by the user. Avaya one-X™ Portal for IP Office users can also select an option to enter Touch Tones (DTMF digits) in an active call.

Active calls can be easily parked by clicking on a park slot whilst displaying the active call. Four Call Park slots/zones, which can be shared between users and operators, or within a department on the same IP Office system, further add to the ease with which the entire call handling process is streamlined with Avaya one-X™ Portal for IP Office. Such parked calls can be retrieved either through Avaya one-X™ Portal for IP Office, Phone Manager, SoftConsole or a desktop phone. The call park slot names can be configured by the user.

### Conferencing Controls

Avaya one-X™ Portal for IP Office allows the setting up of an ad-hoc conference call from calls on hold and/or the directory, or a meet-me conference. It is possible to configure the Conference ID of the user for meet-me conferences.

Once the conference is set up the conference originator will have the following functions:

- mute/unmute a party/oneself
- mute/unmute all
- drop a party from the conference
- hold the conference while others keep talking
- record the conference
- drop all parties in a conference
- lock/unlock a conference (meet-me conference only)
- Loudest speaker detection in an active conference (meet-me conference only)

# Call Log Gadget

## Call History

The call log displays details of calls you have made, received and missed and it will report the last 30 calls. Users can use the call log to make a call or add the caller to the Personal Directory.

The call log shows the actual call history, independent of whether the user was logged in at the time or not. The call log is centralized and also available on the desktop phone.

Calls are ordered in 4 tabs:

- **All**: all calls.
- **Incoming**
- **Outgoing**
- **Missed**

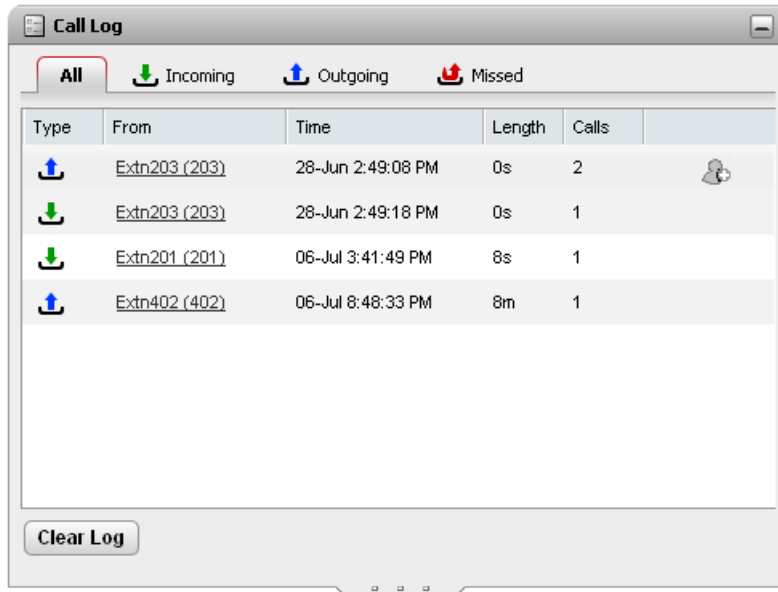

Each tab can be ordered by name, number, time of the call, duration, number of calls and call type. The order can be ascending or descending.

To make a call from the call log, the user simply clicks on the number they wish to call.

# Messages Gadget

## Voicemail Access

Avaya one-X™ Portal for IP Office will show new, saved and old voicemails received and provides access into the user mailbox allowing the user to play, rewind, fast-forward, save and delete messages.

The voicemails can be ordered by state (new, saved, read, private, urgent), caller, called party, time and length. The order can be ascending or descending.

The user can easily call back the caller who left a message from the message gadget.

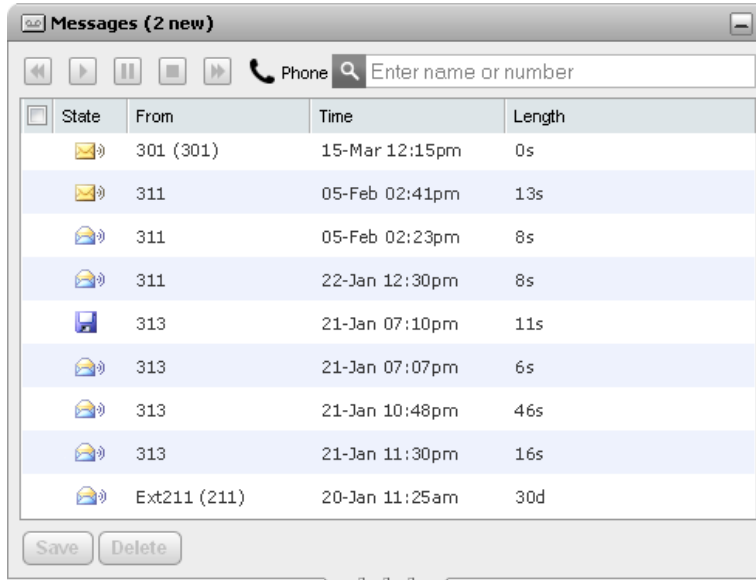

## Directory Gadget

### Directories

Avaya one-X™ Portal for IP Office can display several directories of names and associated telephone numbers.

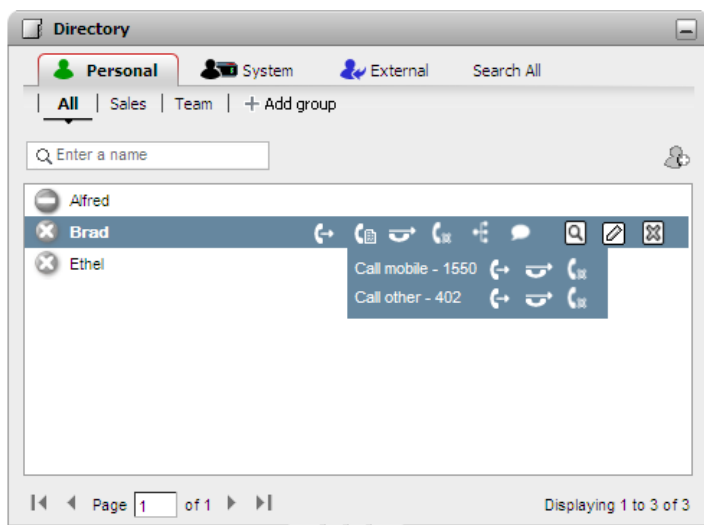

- **Personal Directory**

This is the user's own directory of names and numbers. The user can associate multiple numbers (e.g. work, home, mobile, etc.) with a name and select which number to use when making a call. They can also edit and change the directory entries. The personal directory can contain up to 100 entries. The personal directory is common with the 1400, 1600 and 9600 Series telephones (as well as T3 telephones in selected EMEA countries).

  - The Avaya one-X™ Portal for IP Office user can add up to 4 additional tabs for personal directory contacts,
- **System Directory**

This is the directory of names and numbers from the IP Office telephone system plus all the users and groups on the telephone system. These entries cannot be changed, but the user can copy a system directory entry into your personal directory and modify it.
- **External Directory**

The system administrator can configure Avaya one-X™ Portal for IP Office to access one external directory (Active Directory / LDAP).

Searching the directories is easy: with the Personal Directory and the System Directory, as you enter a name or number in the box at the bottom of the tab, only matching directory entries will remain in view.

With the External Directory, you must enter a name or number to perform a search.

The user can make a call directly from the directory gadget by clicking on the number associated with the entry. If more than one number is available for this entry, they can choose which one to call.

### Presence and Instant Messaging

Avaya one-X™ Portal for IP Office for IP Office provides a Presence and Instant Messaging Service that facilitates communications both internal and external to the organization. It shows presence for any of the people added in the Directory gadget.

The Directory gadget displays the presence status of a user that reflects telephony presence (phone activity such as available/busy/ringing), user presence (Available/DND/Offline) and presence information from Microsoft Exchange calendar mining (in an appointment, out of office set). In addition it supports Presence Federation via XMPP which allows display of information published by buddies using other presence networks such as the Google Talk network. With federation, a user can add a buddy on another system by specifying that user's XMPP ID when defining the new buddy.

The Instant Messaging service allows users to communicate with internal and external users using instant messages from within Avaya one-X™ Portal for IP Office.

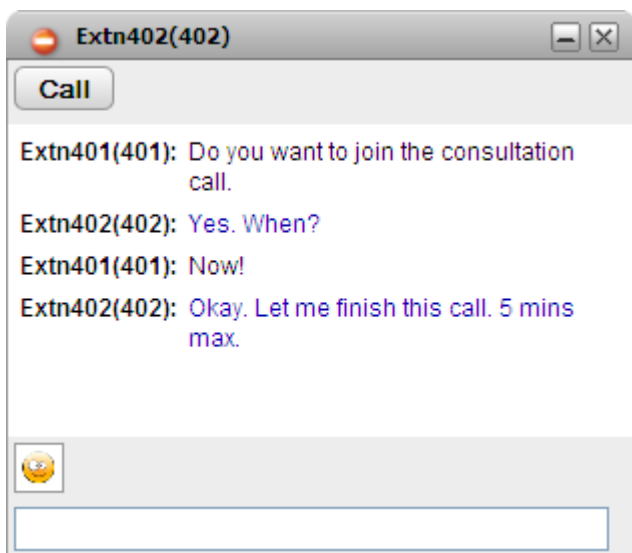

Users can also set a custom Presence status message that will be published to their subscribers as illustrated below.

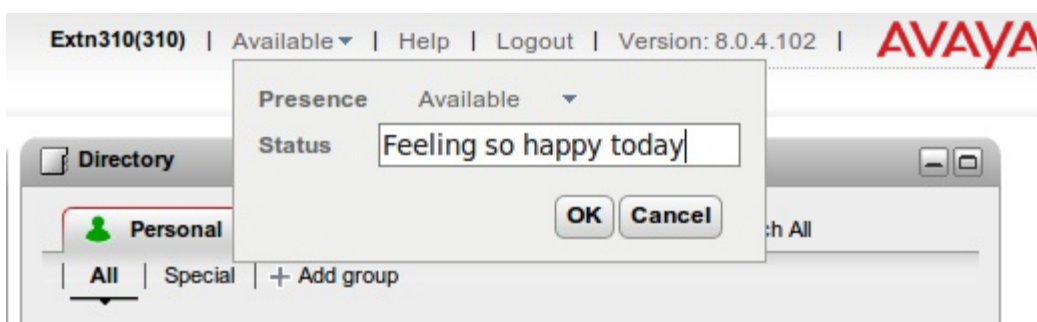

The status can be:

State	Icon	Description
<b>Available</b>	available	The status indicates that you are available and can be called.
<b>Busy</b>		The status indicates that you have a call in progress.
<b>Do Not Disturb</b>		The status indicates that you have enabled <b>Do Not Disturb</b> on the phone system. Calls to you are redirected to voicemail if available. Otherwise, the callers receive a busy tone. The exception is calls from numbers that you have added to your list of <b>Do Not Disturb Exceptions</b> .
<b>Logged Out</b>		The status indicates that you have not logged into the extension on the phone system. Calls to you are redirected to voicemail if available. Otherwise, the callers receive a busy tone. You cannot make calls. However you can still use Avaya one-X™ Portal for IP Office to alter your configuration settings.
<b>Ringing</b>		This status indicates that the phone is ringing and you have an incoming call.
<b>Unknown</b>	unknown	This status indicates that your presence on the phone system is unknown. The presence cannot be determined as the phone number is not an extension on the IP Office

Presence within Avaya one-X™ Portal for IP Office allows the user to create sets of call redirection settings. Through the configuration tab the user can create different Presence entries and associate different rules to each such as forwarding to a different number or Do Not Disturb. In case of Do Not Disturb, the user can establish a list of numbers (DND exceptions) from whom the user wants to receive calls.

**My Buddy**

The Directory gadget provides each Avaya one-X™ Portal for IP Office user with a "MyBuddy" icon. MyBuddy is a virtual person that responds to commands entered by the user in his/her chat window. MyBuddy is always online/available, has an Avaya Avatar, and has a status message of "Type help for a list of commands". A user can type in commands for call management to place a call, find a person, list missed calls etc.

---

## World Clock Gadget

The World Clock gadget shows you the current time in different time zones previously selected.

---

## Agent Control Gadget

If the user is also a Customer Call Reporter agent, this gadget is displayed. Users can use it to see their current agent state and change that state.

- In Agent Control Gadget, Agents are offered the ability to set their state as:
- Available
- After Call Work
- Busy Not Available

It can also be used to change the membership status in the different Customer Call Reporter queues to which the user belongs.

## Personalizing the Layout

There are a number of ways in which the Avaya one-X™ Portal for IP Office gadgets layout can be adjusted. Any changes made are stored by the Avaya one-X™ Portal for IP Office in your user settings so the saved version is always available when the user logs in again.

Change the Avaya one-X™ Portal for IP Office layout:

- Select a Skin – there are 2 skins available to choose from
- Change the Column Widths – the screen is divided in two columns of variable width.
- Show/Hide a Gadget – it is possible to minimize unused gadgets and use the available space for the used ones.
- Resize a Gadget – by dragging the resize icon at the bottom of the gadget it is possible to change the size of a specific Gadget. You can also maximize a gadget to occupy the entire one-X Portal space.
- Move a Gadget – by dragging the gadget itself
- Default the Layout – go back to the factory default.

## Extensibility with 3rd Party Gadgets

Avaya one-X™ Portal for IP Office enables extensibility by allowing a user to add 3rd party gadgets to the Avaya one-X™ Portal for IP Office. This allows a user to improve productivity by combining his/her Unified Communications workspace with the personal workspace. An external gadget is a pre-built piece of code that is remotely hosted and interacts with a third-party website to provide added functionality to a website. Web gadgets from gadget providers/syndications like Google, Zoho, etc. are pre-integrated with Avaya one-X™ Portal for IP Office client. Gadgets provided by default include gadgets from categories such as Communication, Finance, Technology as well as Productivity utilities like calculators, language translators, currency converters etc. The 3rd party gadgets can be added to a new tab within Avaya one-X™ Portal for IP Office.

In addition to the third party gadgets provided with the default installation of Avaya one-X™ Portal for IP Office, new gadgets can be added (configured) into the Avaya one-X™ Portal for IP Office system by the Administrator for use by users. The Administrators can manually provision an external gadget by providing the gadget parameters to add a gadget. They can also export and import gadgets to speed up installation time.

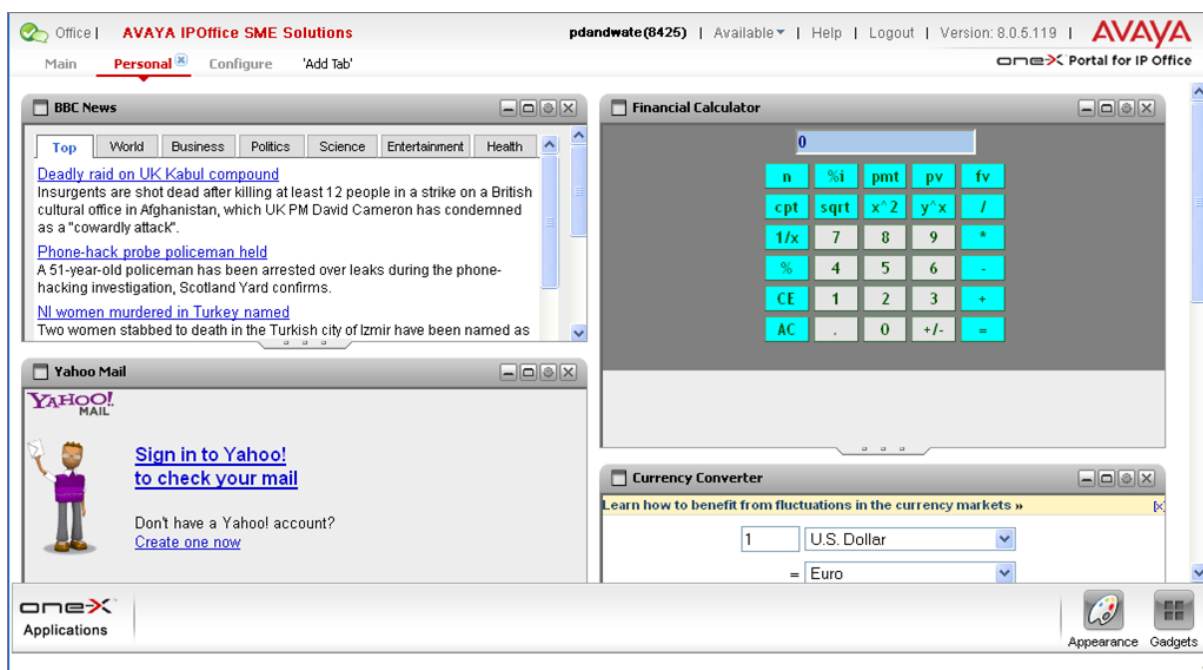



---

## Profiles

By setting and creating using profiles the user is able to easily control where your calls are directed and how they are treated.

There are 3 default profiles, called Office, Mobile and Home. These can be edited but not deleted. The user can create up to 5 additional profiles. A special profile called Detected may also appear and it is displayed when the current telephone system settings don't match any of the profiles.

By selecting which of the saved profiles is the current one, the user applies that set of settings to the telephone system.

When creating or editing a profile, there are 4 settings that the user will have to select:

- **Mobility** - The user can choose between:
  - The default desk phone
  - A number to forward the calls to
  - Mobile Twinning with the number to twin
  - Telecommuter with the number where the user is based
- **Voicemail** - The user can choose to activate/deactivate the following options
  - Voicemail on call not answered
  - Voicemail ringback
  - Voicemail Outcalling
  - Voicemail to be listened to on PC or on phone.
  - Active Greeting – The user can choose which recorded greeting to make active.
- **Call Pick Up** – on/off

---

## Call Assistant

The one-X Call Assistant is an application that performs a range of functions, even if you have not logged into Avaya one-X™ Portal for IP Office using the browser. When you make and receive calls, the one-X Call Assistant displays messages on your Windows desktop even if you do not have Avaya one-X™ Portal for IP Office running.

Call Assistant is an optional desktop application that enables the following functions:

- **Screen pop when receiving a call**  
The screen will show the name (if in the personal or system directory) and number of the caller and the user can answer or drop the call by clicking on the relevant button.
- **Outlook Contact Pop**  
It will also give the option to automatically pop up the Outlook 2003/2007 Contacts entry for the caller or the called.
- **Hot Key**  
The one-X Call Assistant can be used to make a call by dialing a number selected in a Windows application. To do this, simply select or highlight the number in the Windows application and then press your one-X Call Assistant's hot key combination.

## Feature Summary

Feature	Phone Manager Lite	Phone Manager Pro	Avaya one-X™ Portal for IP Office
Web browser based	-	-	Yes
OS independent (Windows, Linux, Mac support)	-	-	Yes
Click to dial	-	-	Future
Citrix/terminal server support	-	-	Future
Inbound/outbound call handling	Yes	Yes	Yes
Phone call control	Yes	Yes	Yes
Configure phone preferences	Yes	Yes	Yes
Configure keyboard short cuts	Yes	Yes	Yes
CLI (ANI) / Name display	Yes	Yes	Yes
Speed dial / Busy Lamp Field management	Yes - 15 icons maximum.	Yes - 100 icons maximum per tab.	Yes - from Personal & System Directory
Speed Dial tabs (to group Busy Lamp Field icons)	Yes - 1 tab.	Yes - 10 tabs maximum.	Yes - 5 Personal Directory tabs maximum.
Transfer call by drag and drop to a speed dial icon	-	Yes	-
View internal users' presence	Yes (Telephony + LCS <sup>[1]</sup> )	Yes (Telephony + LCS <sup>[1]</sup> )	Yes (Telephony + User Status) + Custom Presence status + Presence from calendar mining + Presence from other supported networks
Send Instant Messages (IM) to internal users	Yes (requires LCS <sup>[1]</sup> )	Yes (requires LCS <sup>[1]</sup> )	IM to internal and external users from supported Presence networks
Telecommuter mode	-	Yes (not PC Softphone)	Yes
Mobile Twinning Configuration	-	-	Yes
Call Pick Up	-	-	Yes
Compact mode	-	Yes	Yes - Call Assistant
Personal Phone Directory	-	Yes - 1000 entries maximum.	Yes - 100 entries maximum
System Phone Directory	-	Yes - 5000 entries maximum.	Yes - 5000 entries maximum
External Phone Directory (e.g. LDAP/Active Directory)	-	Yes - 5000 entries maximum.	Yes - unlimited
Call history log - all, missed, messages	Yes - while logged in.	Yes- while logged in.	Yes - 24/7 call log
Separated incoming/outgoing call log	-	Yes	Yes
Collect new voicemail messages	Yes	Yes	Yes
Voicemail box control (Intuity and IP Office modes)	-	Yes	Yes
Personal Distribution List set up (Intuity mode)	-	Yes	-
Incoming call scripting	-	Yes	-
Time on call	-	Yes	Yes
Advice of Charge (ISDN service provider dependent)	Yes	Yes	-
Door opening control	-	Yes	Yes (via analog extension)

Feature	Phone Manager Lite	Phone Manager Pro	Avaya one-X™ Portal for IP Office
Queue monitoring	-	Yes - 2 Queues	Future
Conference Control Display	Yes	Yes	Yes
Audio Conference Management	No	No	Yes
'Screen pop' contacts with Outlook	-	Yes	Yes
Simple Outlook contact record creation	-	Yes	-
Agent Mode	-	Yes	Yes
Distinctive Ringing (WAV file)	-	Yes	-
Post Connect dial (sending DTMF while connected to another party)	Yes	Yes	Yes
VoIP mode (to run as an PC Softphone)	-	Optional license	Yes (with Power User and Teleworker licenses only)
Video Softphone	-	-	Yes (with Power User and Teleworker licenses only)

1. LCS: Microsoft Live Communications Server 2003.

## Server, Browser and Other Requirements

- **Phone support**  
Any telephone connected to IP Office, although handsfree operation is only supported on suitable Avaya Digital and IP telephones.
- **Server and Browser requirements**
  - Avaya one-X™ Portal for IP Office supports the following browsers:
    - Microsoft Internet Explorer versions 7, 8, and 9
    - Mozilla Firefox version 3.0 and above
    - Apple Safari 4.0 and above
  - The server requirements for Avaya one-X™ Portal for IP Office deployments up to 200 users are:
    - Intel Pentium D945 core/AMD Athlon 64 4000+; with 4 GB RAM and 20 GB free hard disk space
    - OS supported: Windows Server 2003 or 2008 (32 and 64 bit)  
**Note:** Windows Server 2003 requires the hotfix found at <http://support.microsoft.com/kb/925336>
  - The server requirements for Avaya one-X™ Portal for IP Office deployments greater than 200 users are:
    - Intel Core 2 Duo CPU E8400 @ 3.00 GHz, 6GB RAM and 20GB free hard disk space
    - OS supported: Windows Server 2008 (64 bit)
    - Always refer to the latest Avaya IP Office Technical Tip or Technical Bulletin for any updated information with regard to Operating Systems, Service Packs or PC hardware.
- **Licensing**  
Avaya one-X™ Portal for IP Office requires a license for each user. The license can be an IP Office Power User, Office Worker or Teleworker user license. The Telecommuter mode and IP Office Video Softphone are available only with a Power User or Teleworker license.

## Avaya IP Office Plug-in for Microsoft Outlook

Microsoft Outlook is an application that many knowledge workers invoke in the morning and keep running all day. The IP Office Plug-in for Microsoft Outlook brings a subset of the Avaya one-X™ Portal for IP Office user experiences to Outlook. The plug-in allows the user to communicate with contacts without leaving the Outlook window and without needing to bring up separate client applications. This vastly improves user productivity.

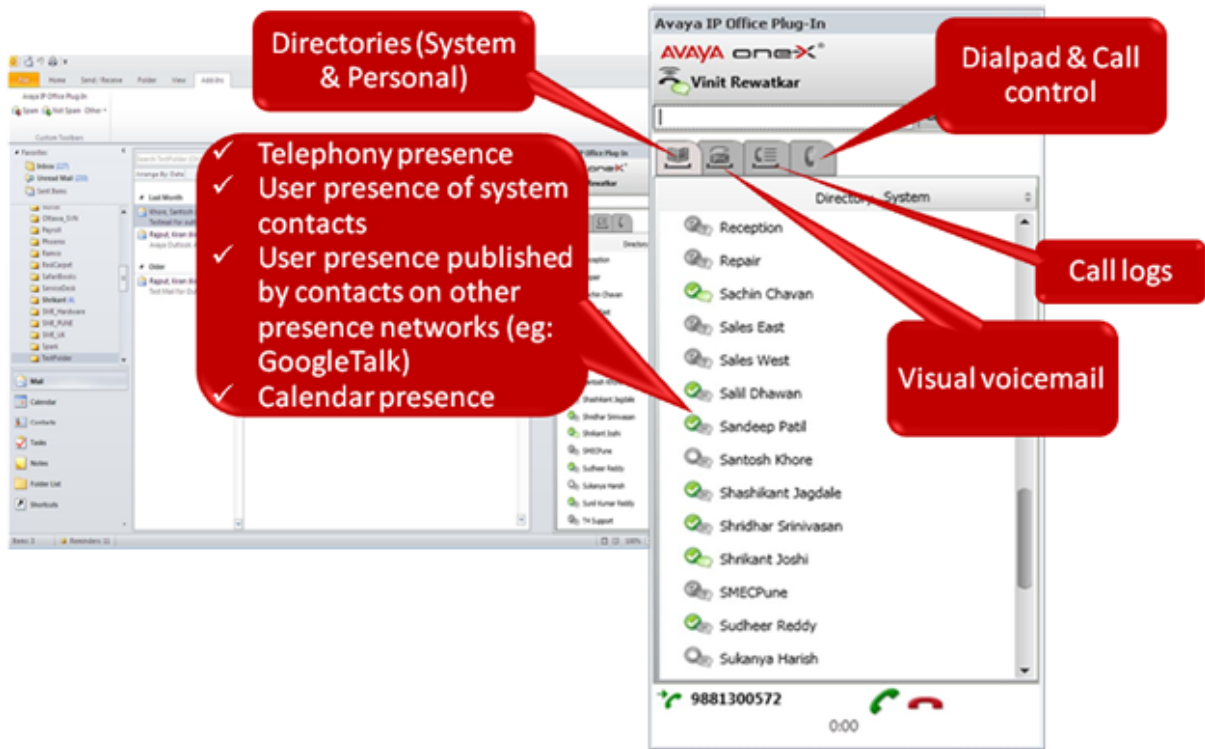

Avaya IP Office Plug-in for Microsoft Outlook provides the following features:

- Initiate a voice call (to work, to home or other numbers)
- Get notifications for incoming calls with options to accept or reject
- Listen to voicemail
- View Call history
- Export Outlook contacts to Avaya one-X™ Portal for IP Office Server
- Show presence of users - Telephony presence, User presence of other system contacts, User presence published by contacts on other presence networks (e.g.: GoogleTalk), Calendar presence
- "Collapse" plug-in window to avoid capturing the entire screen. UC features will continue to be available to the Outlook user
- Click-to-Call options on context menu of a contact from Outlook Contacts directory or from Outlook Calendar (number should be in Location field)

The Avaya IP Office Plug-in for Microsoft Outlook can be downloaded from the Desktop Integration tab of the Avaya one-X™ Portal for IP Office. The plug-in is supported on the WinXP+SP3, Windows Vista and Windows7 operating system for Microsoft Outlook versions 2003, 2007 and 2010.

## Avaya IP Office Plug-in for Salesforce.com

IP Office Release 8.0 enables integration with Salesforce.com for business users. This integration enables Salesforce.com customers that are using IP office for their telephony needs to control calls from within the Salesforce.com portal itself. This integration is enabled by the "Avaya IP Office Plug-in for Salesforce.com," which is a Windows application that runs in the system tray, and provides the following features from the Salesforce.com soft client available within the Salesforce.com portal:

- Call Control (Make, Receive, Hold/Unhold, Transfer, Mute a call)
- Inbound and outbound calls automatically added to Salesforce.com portal call history
- Click to dial from any contact or phone number within Salesforce.com portal
- Screen pops of customer information (contact, case etc.) on caller-id and name for inbound and outbound calls

The screenshot below captures the Salesforce.com Portal with the phone integrated to IP Office.

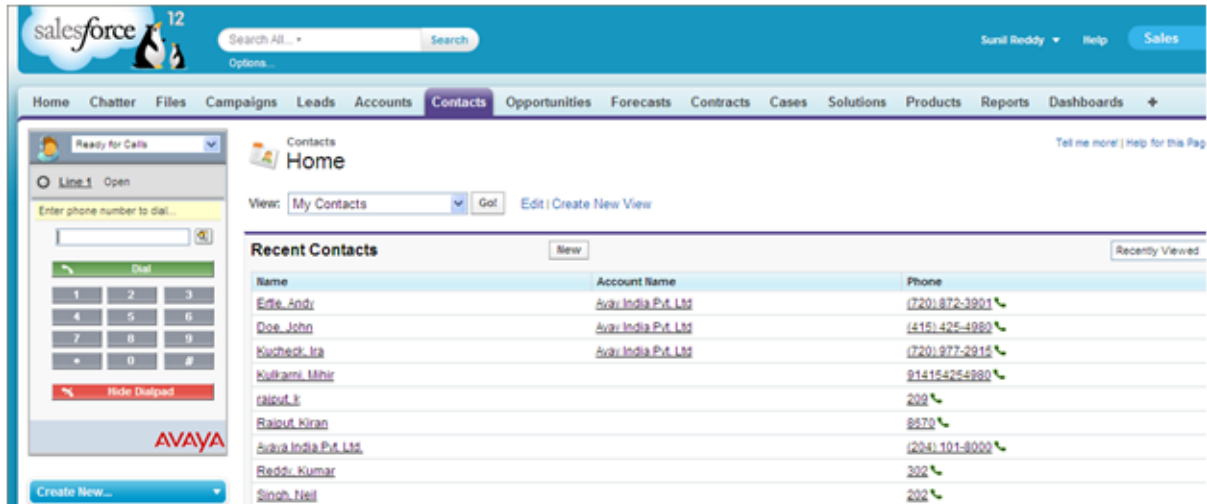

The Avaya IP Office Plug-in for Salesforce.com can be downloaded from the Desktop Integration tab of the Avaya one-X™ Portal for IP Office. The plug-in is supported on the WinXP+SP3, Windows Vista and Windows7 operating systems.

### Supported browsers

- For Windows XP: Internet Explorer 7.0 or later; Firefox 3.5 and Firefox 3.6
- For Windows 7: 64-bit Internet Explorer 8; Firefox 3.5 and Firefox 3.6

### Licensing

Avaya IP Office plug-in for Microsoft Outlook and Avaya IP Office plug-in for Salesforce.com require an Avaya one-X™ Portal for IP Office license for each user. This license is part of the IP Office Power User, Office Worker or Teleworker user license and is not available separately.

---

## IP Office Video Softphone

---

With Release 6, IP Office introduced – as part of the Teleworker and Power User package – a new softphone application; IP Office Video Softphone.

Release 8 introduces a number of new features to the IP Office Video Softphone application:

- A version of the client for the Mac OS environment (not functionally aligned with the Windows version)
- Busy Lamp Field (BLF) busy beep support
- The ability to send and receive Instant Messages
- Video conference for up to six participants
- Support for the G.722 codec option

The IP Office Video Softphone is a full feature telephony client that supports standard telephony features on a PC running Microsoft or Mac operating systems.

Support of several audio options including support of wireless headsets with full hook-switch support provides a flexible telephone option, especially for people on the move.

IP Office Video Softphone is part of the Teleworker and the Power User package. An applicable Teleworker/Power User license for the user of the IP Office Video Softphone is required; however IP Office Video Softphone does not require any additional license, e.g. no (Avaya) IP-station license.

IP Office Video Softphone can run in two different operating modes - client mode and application mode.

### IP Office Video Softphone Application Mode

IP Office Video Softphone runs in the background and standard call control is accomplished through productivity applications, such as Avaya one-X™ Portal for IP Office that is part of the User profiles described above. If run with Avaya one-X™ Portal for IP Office it provides the following additional value:

1. Consistent user interface when using Avaya one-X™ Portal for IP Office with a desktop phone, in telecommuter mode or in combination with IP Office Video Softphone.
2. Off-line call log with updates even when IP Office Video Softphone is not logged in
3. Additional features of Avaya one-X™ Portal for IP Office, e.g. presence and instant messaging.

## IP Office Video Softphone Client Mode

IP Office Video Softphone provides its own User interface, similar to a standard IP Office telephone for making calls, transferring calls, multiple call appearances or making conference calls. A programmable feature button list allows one-touch access to standard IP Office features. This is the preferred usage scenario for customers not running other IP Office productivity applications like Avaya one-X™ Portal for IP Office. It is also the preferred operation mode for users who want to smoothly migrate from their desktop phone or who use IP Office Video Softphone only occasionally and prefer a phone-centric user-interface, with optional dial pad and standard phone feature keys. The picture below shows the IP Office Video Softphone with dial pad and feature keys, plus a view of the new Speed dial tab to illustrate the Busy Lamp Field.

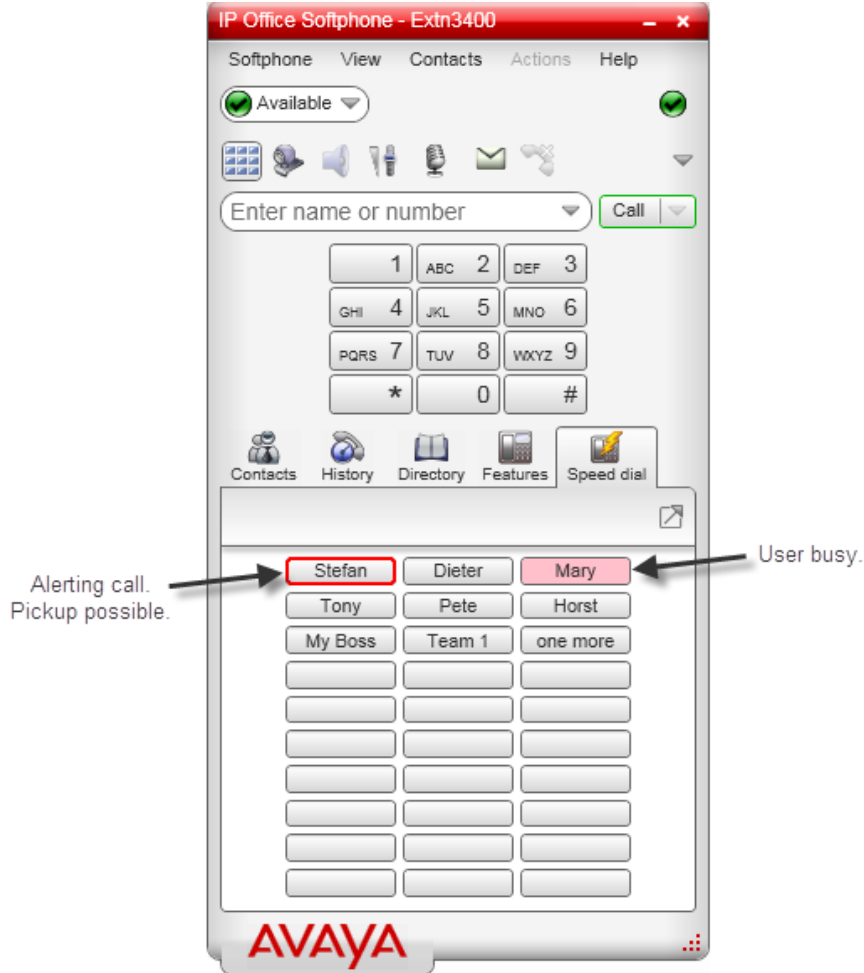

*IP Office Video Softphone - Speed dial tab and Busy Lamp Field.*

The user interface is flexible, allowing adjustment for personal preferences with detachable specific windows like the contact list window and Features buttons.

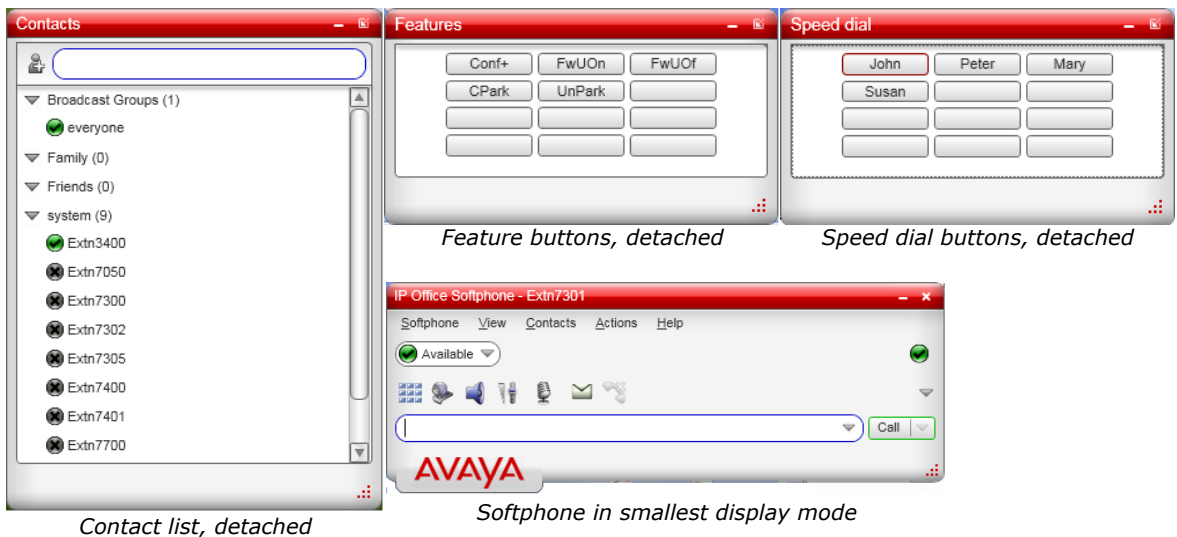

*Contact list, detached*

*Feature buttons, detached*

*Speed dial buttons, detached*

*Softphone in smallest display mode*





## Video Support

As well as audio calls, IP Office Video Softphone supports end to end video calls on a single IP Office or within an IP Office Small Community Network. The IP Office Video Softphone also provides the ability to establish video conference calls with up to six participants.

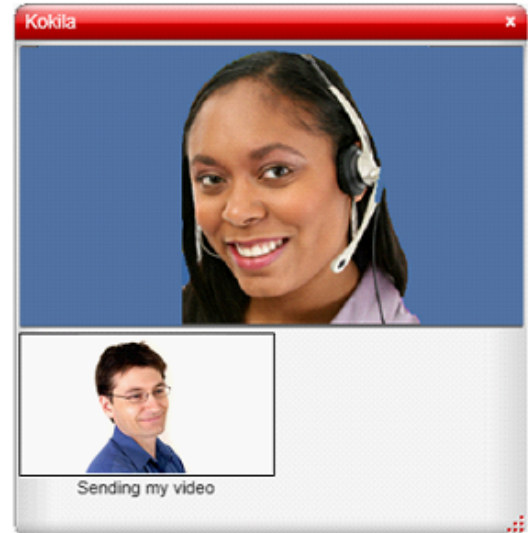

Video adds a new level of interaction to the standard phone communication so this is especially useful for users working from a remote location, needing to get in touch with colleagues in the main site or when used in an IP Office Small Community Network.

---

## Feature Overview

The following feature overview is applicable when using the IP Office Video Softphone in Client mode. When used in application mode, functionality depends on that application.

- Making and receiving calls
- Sending and receiving instant messages to/from contacts
- Multiple Call Appearances (No bridged or line appearances)
- Hold, transfer (attended and unattended)
- Message waiting with direct voicemail access
- Audio Conference (IP Office based)
- Video Conference (softphone based)
- Local call log, local directory
- Access to IP Office directory (system, corporate, personal)
- Feature keys for up to 12 IP Office features like:
  - Forwarding (various methods like all, busy, no answer)
  - Park/Unpark
  - Pick up (any, group, member)
  - Voice-Mail on/off
- Speed Dial Tab with Busy Lamp Status:
  - Free Configurable Speed Dials: 12-60 Buttons
  - Visual Indication of User Status (Busy, Alerting)
  - Pick-Up of Alerting calls
  - Busy beep support

Features keys can be selected and self administered from a list of features that is downloaded from IP Office.

If equipped with an audio device with hook switch control, IP Office Video Softphone allows calls to be made or answered even when the screen-saver of a PC is activated and the PC is locked. Until the PC is unlocked, no screen will be shown but ringing calls can be accepted through e.g. a headset with hook-switch.

## Licensing and Provisioning

IP Office Video Softphone forms part of the Teleworker or Power User profile. A user can log onto the IP Office Video Softphone using their normal username and password. License entitlement will be checked against that user before the login is accepted.

Unlike Avaya hard telephones, IP Office Video Softphone does not require an Avaya IP Phone License to work on IP Office.

While the IP Office Video Softphone is a thick client application, it is extremely easy to install and provision. Installation of the application on a standard PC requires minimal to no configuration as all provisioning of the product is done from the IP Office as a provisioning server.

If a DHCP server is present and set up correctly, Softphone will completely configure itself. The user only needs to enter the username and password to get connected.

If DHCP is not available, the user needs to enter a single IP address of the IP Office; all other parameters will be set automatically.

IP Office Video Softphone can be set up so that, when the PC starts up, the application is automatically started with the default username and password. The user can disable automatic login as well as interrupt it any time.

## Username and Twinning

When logged in to IP Office Video Softphone with their username and password, the user will automatically be logged off from their existing desktop extension, so the user is fully available on their normal number without any additional steps.

For users that are using a physical telephone e.g. in the office, this is very convenient as they do not use a different extension for Softphone calls. All calls will be routed automatically to the IP Office Video Softphone when logged in. There is no need to use twinning to tie the IP Office Video Softphone to the standard desktop phone.

## Supported Audio and Video Hardware

IP Office Video Softphone can run with any Windows or Mac sound device supporting full-duplex quality. If possible, audio devices are automatically detected and allocated to the IP Office Video Softphone.

IP Office Video Softphone supports simultaneous operation of two sound devices, e.g. a headset or USB handset for normal calls and a USB handsfree unit for handsfree operation. It is possible to switch between the sound devices at any time during the call.

For alerting, in addition to that the PC speakers can be activated to ring the phone.

For ease of use, similar to desktop telephones, IP Office Video Softphone supports USB devices for audio as well as for call control, e.g. accepting and terminating a call. IP Office Video Softphone supports the "HID" standard for USB devices allowing generic USB devices to be configured.

## Supported Audio and Video Codecs

IP Office Video Softphone supports G.711, G.722, and G.729 Audio Codecs. Audio Codec negotiation is done by IP Office in order to ensure best quality for local or SCN calls. At login, the user can select the default mode, e.g. best quality or low bandwidth for remote operation.

For video, IP Office Video Softphone supports H.263, H.263+ and H.264 Video Codecs with resolution of up to 1280 x 768 pixels and 30 frames per second.

Resolution	Pixel	Typical Net Video Bandwidth Requirement	
		H.263	H.264
Low	176 x 144 (QCIF)	64 kbps	45 kbps
Standard	320 x 200 (QVGA)	162 kbps	114 kbps
High	640 x 480 (VGA)	776 kbps	545 kbps

Note: The above numbers show an average bandwidth requirement but peak usage might be higher. The above numbers do not include the audio-bandwidth.

## Supported Languages

Currently the following languages are supported:

- **English**
- **French**
- **Italian**
- **Portuguese**
- **Russian**
- **Simplified Chinese**
- **Spanish**

The product will support more languages in the future.

## PC Requirements

### Processor:

- Minimum: Pentium 4 2.4 GHz or equivalent, Video Card with DirectX 9.0c support
- Optimal: Intel Core Duo or equivalent, Video Card with DirectX 9.0c support.

### Memory:

- Minimum: 1 GB RAM
- Optimal: 2 GB RAM

**Hard Disk Space:** 50 MB

**Operating System:** Windows XP Service Pack 2, Windows Vista, 32-bit and 64-bit, Windows 7 32-bit and 64-bit.

**Additional:** Microsoft Windows Installer 3.1, Microsoft .NET 3.5 SP1, Microsoft VC 9.0 Runtime Service Pack 1

**Connection:** IP network connection (broadband, LAN, wireless)

**Sound Card:** Full-duplex, 16-bit or use USB headset

**For HD video, the minimum requirements are Intel Core 2 Duo 2.3 GHz or equivalent, hardware video acceleration, camera and 2GB RAM**

Note that these are recommendations. Depending on other applications on the PC, Softphone cannot guarantee uninterrupted Voice and/or Video quality. While Softphone runs with high priority on the PC in order not to be impacted by normal applications other programs with similar priority could impact Softphone performance. Example applications could be other Multimedia or communication applications like web-sharing programs or programs that are essential for PC performance like some Virus-scanners or firewall programs.

## Mac Requirements

### Processor:

- Minimum: Pentium 4 2.4 GHz or equivalent, Video Card with DirectX 9.0c support
- Optimal: Intel Core Duo or equivalent, Video Card with DirectX 9.0c support.

### Memory:

- Minimum: 1 GB RAM
- Optimal: 2 GB RAM

**Hard Disk Space:** 50 MB

**Operating System:** Mac OS 10.6 (Snow Leopard)

**Connection:** IP network connection (broadband, LAN, wireless)

**Sound Card:** Full-duplex, 16-bit or use USB headset

**For HD video, the minimum requirements are Intel Core 2 Duo 2.3 GHz or equivalent, hardware video acceleration, camera and 2GB RAM**

Note that these are recommendations. Depending on other applications on the Mac, IP Office Video Softphone cannot guarantee uninterrupted Voice and/or Video quality. While IP Office Video Softphone runs with high priority on the Mac in order not to be impacted by normal applications, other programs with similar priority could impact IP Office Video Softphone performance. Example applications could be other Multimedia or communication applications like web-sharing programs or programs that are essential for performance like some Virus-scanners or firewall programs.

---

## Flare Communicator

---

Avaya Flare Communicator is a collaboration software client that delivers an innovative interface for real time communications for Windows and on the iPad. It enables users to handle phone calls, instant messages, presence, enterprise contacts and launch e-mail, all from the same interface. Flare communicator delivers the intuitive graphic design of the Avaya Flare® Experience—"spotlights," media menu, notification bar, and contact cards. This provides a new level of collaboration for users and is the first step in extending the Avaya Flare Experience to non-Avaya devices.

Avaya Flare Communicator for Windows and iPad tablets will be supported on IP Office Release 8.1. With its contextual, people-centric design, the Avaya Flare Communicator for IP Office will make communications and collaboration easier and more convenient than ever before for SME and mid-market customers.

## Flare Communicator Solution Architecture

Flare Communicator for IP Office communicates with both IP Office and one-X Portal to provide communication and collaboration features. Telephony features such as make/receive calls, hold/un-hold, mute/un-mute, DTMF, MWI etc. are provided by IP Office 500v2 and UC features such as IM, presence, and enterprise contacts are provided by the one-X Portal server.

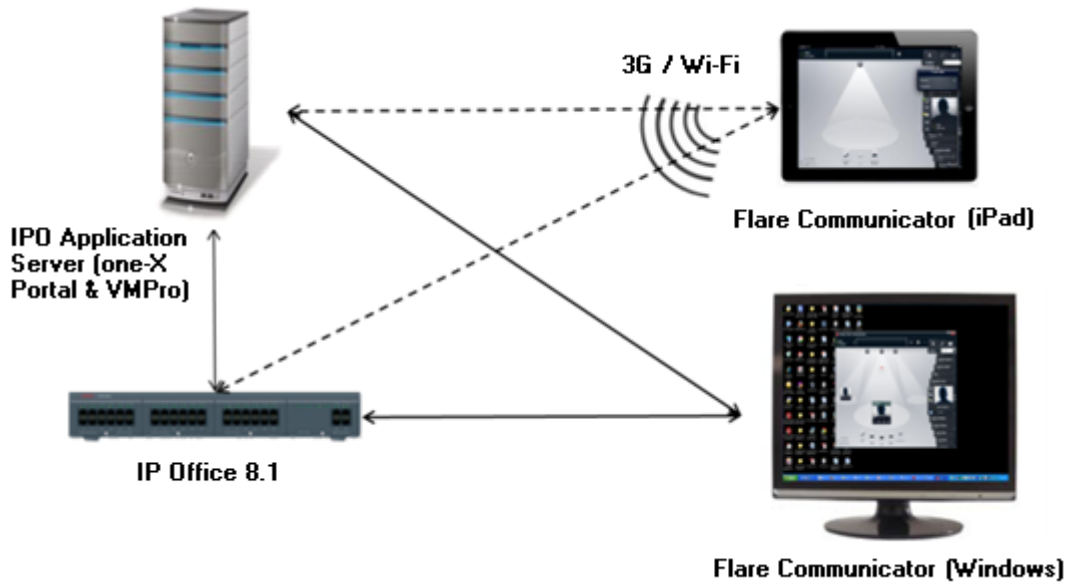

If one-X Portal server is unavailable, either due to licensing restriction or connectivity issues, the Flare Communicator client will work in a telephony-only mode providing only telephony features.

## Flare Communicator for Windows

Flare Communicator for Windows integrates voice, presence, IM, and directories into one unified offering for Windows laptops and desktops over a LAN connection. It allows users to gain integrated access to communications modes—move among drag-and-drop voice, IM, email, call history, and more.



## Real-time Communication and Collaboration Features

Flare Communicator for Windows will support the following real-time communication and collaboration features for IP Office:

### **Contact management features**

- IP Office System and Personal contacts
- Outlook contacts (appended to Personal contacts)
- Index, scroll through contacts
- Filter contacts
- Touch to add contact
- Search for enterprise contacts and touch-to-call from search results

### **Voice call features**

- Make, Receive, and Disconnect calls (2-party)
- Mute, Unmute, Hold, and Resume calls
- Manage up to three concurrent voice calls
- DTMF mode
- Message Waiting Indicator
- Dial into a voice conference bridge

### **Collaboration features**

- View telephony and user presence of IP Office users
- Set your telephony and user presence
- IM between IP Office soft clients (2-party)
- Escalate from an IM message to a voice call
- Launch emails from a spotlight or contact card

## Installation and Configuration

For installation of Flare Communicator for Windows:

- Download and install the application from the Avaya support site at <http://support.avaya.com>

**or**

- Configure the application settings by providing the IP Office 500v2 or IP Office on Linux IP address and port, domain, dialing rules (optional), enterprise directory settings (optional) on the Settings tab

## Operating System and Device Support

Flare Communicator for Windows is supported on the following Windows operating systems:

- Microsoft® Windows® 7 Enterprise Edition
- Microsoft Windows 7 Ultimate Edition
- Microsoft Windows 7 Professional Edition
- Microsoft Windows XP Home Edition (32-bit) with Service Pack 3 or higher
- Microsoft Windows XP Professional Edition (32-bit) with Service Pack 3 or higher

## Flare Communicator for iPad

Flare Communicator for iPad integrates voice, presence, IM, directories into one unified offering for IP Office customers over Wi-Fi or 3G cellular and VPN connections.



Flare Communicator for iPad brings enterprise communication capabilities to the iPad tablets for IP Office customers. It is a software-only solution that can be easily downloaded (from the Apple App Store), and is the first step in extending the Avaya Flare Experience to non-Avaya devices.

With Flare Communicator, IP Office customers can use iPad devices for:

- Easy, ubiquitous access to the real-time communications tools they rely on every day(phone, presence, IM, etc.)
- Blending real-time communications and business processes, such as mobile sales
- Taking advantage of Wi-Fi and 3G connectivity for cost-saving VoIP



## Real-time Communication and Collaboration Features

Flare Communicator for iPad will support the following real-time communication and collaboration features for IP Office:

### **Contact management**

- Local iPad contacts and IP Office System and Personal contacts
- Index, scroll through contacts
- Filter contacts
- Touch to add contact
- Search for enterprise contacts and touch-to-call from search results

### **Voice calls**

- Mute, Unmute, Hold, Resume
- Manage up to two concurrent voice calls
- DTMF mode
- Dial into a voice conference bridge

### **Collaboration**

- View telephony and user presence of IP Office users
- Set your telephony and user presence
- IM between IP Office soft clients (2-party)
- Escalate from an IM message to a voice call
- Launch emails from a spotlight or contact card

## Installation and Configuration

For installation of Flare Communicator for iPad:

- Download and install the application from the Apple iTunes store
- or**
- Configure the application settings by providing the IP Office 500v2 or IP Office on Linux IP address and port, domain, dialing rules (optional) enterprise directory settings (optional) on the Settings tab.

## Operating System and Device Support

Flare Communicator for iPad will be supported on the following Apple iPad tablets and Operating System versions:

- iPad2 (or newer) with iOS 5.0+

---

## Localization

Flare Communicator iPad for IP Office will be localized for the following languages: English, Chinese, French, German, Italian, Japanese, Korean, Portuguese, Russian, and Spanish.

Flare Communicator Windows for IP Office will be available only in the English language at GA.

---

## Licensing

The Flare Communicator collaboration software client will be available on the following IP Office editions with the following add-on license:

IP Office Edition	Add-on License	Feature-set
Essential Edition	Avaya Softphone license	<ul style="list-style-type: none"><li>• Telephony functions, IP Office system contacts, local contacts, call logs (application-side)</li><li>• Flare Communicator for Windows and iPad</li></ul>
Preferred/Advanced/Server Edition	Office Worker or Power User	<ul style="list-style-type: none"><li>• Telephony functions, IP Office system contacts, one-X Portal personal contacts, local contacts and call logs, presence, 2-party IM</li><li>• Flare Communicator for Windows and iPad</li></ul>

# Chapter 13.

# Receptionist

# 13. Receptionist

SoftConsole is the PC based Windows Receptionist solution for IP Office. It can be purchased with the Receptionist user license.

SoftConsole has been designed to improve operator service by providing the operator with call information and available call actions to simplify call handling and give the appropriate response to the caller. With this easy to use software tool the operator can maintain visibility of the number and type of calls waiting and so ensure that clients are greeted in a professional manner. SoftConsole can be minimized in the Windows system tray when not in use, but will pop up on the screen when a call is received.

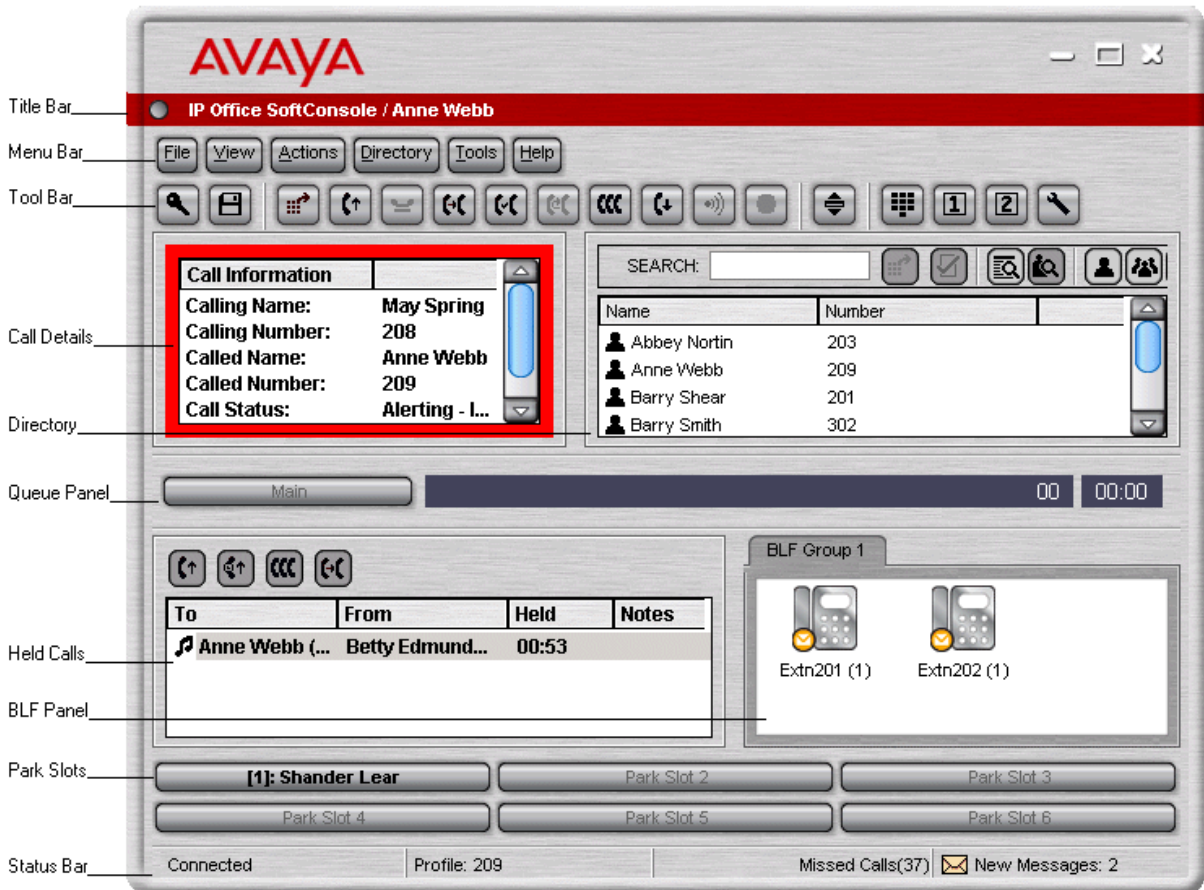

SoftConsole has been designed to be easy to use, while offering a look and feel which will appeal to experienced and novice operators alike.

The SoftConsole screen is divided into the following areas:

- **Main Menu Bar**



Commands and actions are available through menus. Some features can only be used when the right conditions. If they are not available, the feature will be "grayed out" until conditions change that allow the feature to be used. The following features are available on the tool bar:

- Login.
- Save Profile.
- New call.
- Answer call.
- Hold call.
- Transfer call.
- Transfer complete.
- Reattempt transfer.
- Conference.
- Hang up.
- Page.
- Record call.
- Compact view.
- Dial Pad.
- Access conference room 1.
- Access conference room 2.
- Options.

- **Call Details Panel**

Call Information	
Calling Name:	Betty Edmunds
Calling Number:	204
Called Name:	Anne Webb
Called Number:	209
Call Status:	Alerting - Incoming
Duration:	00:02

The call details panel on the left shows details of the current call which will include the following information:

- **Calling Name**  
The system directory name associated with the calling number.
- **Calling Number**  
The telephone number of the call originator.
- **Called Name**  
The system user name or hunt group name associated with the called number.
- **Called Number**  
The extension number the incoming call has been routed to by the system.
- **Call Status**  
States the progress of a call. The border around the call status panel changes color to indicate the status of the call.
- **Call Duration**  
The length of time that the has been in the state as indicated by the Call Status
- **Notes**  
This area displays notes or information about the call i.e. when a call has been returned as there was no answer from the extension it was transferred to. If annotation is attached to the call, details are shown in the Notes area.

If a new call arrives, the call details panel will display the calls waiting to alert the operator and allow answering of the call based on the Caller ID.

- **Directory Panel**

Property	Value
Name:	Anne Webb
Number:	209
Busy Status:	Idle
Do Not Disturb Status:	Off
Login Status:	Logged In
Group Status:	
Main	Out of Group
Sales	In Group
CustomerHelp	In Group
Absent Message:	
New Voice Mail Messages:	2
Forwarding Status:	
Forward Unconditional:	Off
Forward On No Answer:	Off
Forward On Busy:	Off
Follow Me:	Off
Forward Hunt Group Calls:	Off

The directory panel on the right shows information on following:

- **Directory entries**

Including IP Office users, hunt groups and external directory user (non IP Office extensions)

- **Single directory entry details**

Including IP Office users, hunt groups and external directory user (non IP Office user).

- **Script**

When a script has been configured for either the calling or called number, the script is displayed in this panel. For example, an operator may be answering calls on behalf of more than one company. To ensure the call is answered with the correct company name a script file can be created with the company name details. The script is displayed whenever a call is received for that company.

<table border="1"> <thead> <tr> <th colspan="2">Call Information</th> </tr> </thead> <tbody> <tr> <td>Calling Name:</td> <td>Company One</td> </tr> <tr> <td>Calling Number:</td> <td>01707364416</td> </tr> <tr> <td>Called Name:</td> <td>Anne Webb</td> </tr> <tr> <td>Called Number:</td> <td>209</td> </tr> <tr> <td>Call Status:</td> <td>Alerting - Incoming</td> </tr> <tr> <td>Duration:</td> <td>00:05</td> </tr> </tbody> </table>	Call Information		Calling Name:	Company One	Calling Number:	01707364416	Called Name:	Anne Webb	Called Number:	209	Call Status:	Alerting - Incoming	Duration:	00:05	<p>COMPANY ONE</p> <p>All calls are to be announced</p> <p>General Enquiries - Extension 123</p> <p style="text-align: right;">Close Script</p>
Call Information															
Calling Name:	Company One														
Calling Number:	01707364416														
Called Name:	Anne Webb														
Called Number:	209														
Call Status:	Alerting - Incoming														
Duration:	00:05														

- **Conferencing**

Within SoftConsole, calls can be conferenced when held, or a conference can be created through the two conference rooms:

- **Conference Held Calls**

An operator can conference calls that are in the Held Panel. All calls in the Held Panel will be conferenced.

- **Queue Panel**

The queue panel displays a bar graph of the number and the status of external calls held in a particular queue. Up to 8 Call queues can be configured and labeled to reflect incoming calls for specific hunt groups.

Main	<div style="width: 100%; height: 10px; background-color: #333; position: relative;"> <span style="position: absolute; right: 0; top: 0;">00</span> <span style="position: absolute; right: 0; bottom: 0;">00:00</span> </div>
CustomerHelp	<div style="width: 100%; height: 10px; background-color: #333; position: relative;"> <span style="position: absolute; right: 0; top: 0;">02</span> <span style="position: absolute; right: 0; bottom: 0;">00:07</span> </div>

Queue Name: CustomerHelp  
 Calls in Queue: 2  
 Recall Calls: 0  
 Status: Alarmed

- **Held Calls Panel**

The held call panel enables the operator to manage all calls held at the operator station. These calls will appear as a list in panel. The operator can perform the following functions: Answer the highlighted held call, Answer the longest held call, Conference held calls (see conferencing section above) or Transfer held call.

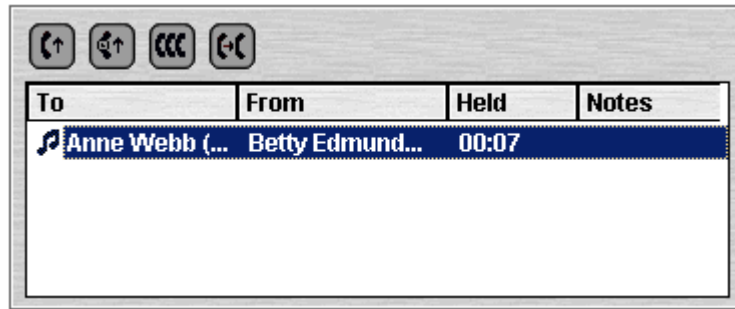

- **BLF Panel (Busy Lamp Field Panel)**

The BLF panel displays icons to indicate the status of selected users. Each icon provides information on individual users such as: Unread 'User' voicemail messages, User status information, for example Busy, DND and Forwarded is indicated by the various icons used. Up to 10 tabs with 100 icons on each tab are supported.

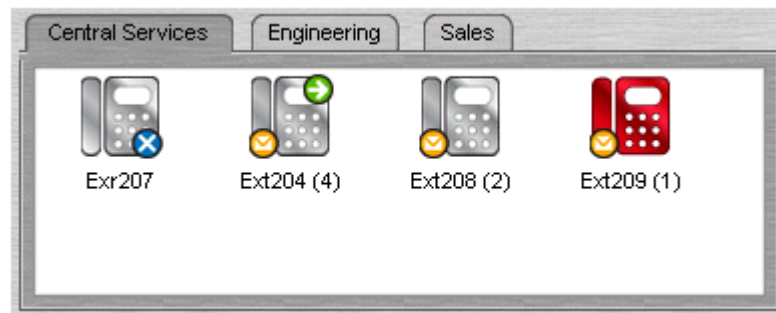

- **Park Slot Panel**

The park slot panel can contain up to 16 system-wide park slots with specific Park ID's for each slot.

- **Call History**

SoftConsole's call history keeps a combined record of up to 100 (incoming, outgoing and missed) calls while the application is active Double-clicking any logged call dials that number.

	Number	From	To	Tag	Date & Time
!	206	Theresa Green	Anne Webb		19/10/2006 15:12:01
!	210	Paul Jones	Anne Webb		19/10/2006 15:12:24
(	209	Anne Webb	?Anne Webb		19/10/2006 15:12:50
(	209	Anne Webb			19/10/2006 15:14:33
)	206	Theresa Green	Anne Webb		20/10/2006 08:53:50
!	206	Theresa Green	Anne Webb		20/10/2006 08:55:09
)	206	Theresa Green	Anne Webb		20/10/2006 08:56:07
(	209	Anne Webb	May Spring		20/10/2006 09:06:28
!	210	Paul Jones	Anne Webb		20/10/2006 09:14:26

- **Status Bar**

This Shows current status of the system and is divided into four sections that display current connection status, current Profile name, information messages and The number of new voice mail messages for the operator. Information messages include any alarm conditions that are present within the system.

---

## SoftConsole Options

---

SoftConsole has many configurable options available to the operator to personalize the look and feel. The following configuration options are available:

- **Incoming Calls**  
This tab enables the operator to manage the local SoftConsole directory by creating, editing and deleting entries from the selected directory. Also the operator is able to associate a script or media file with each specific entry.
- **Queue Mode**  
This tab enables the operator to configure the queue window with up to 8 hunt group queues, which will include a recall queue. Queues can be created, edited and deleted while also providing the operator with the additional benefit of positioning them in the queue window in order of operator preference. Management by exception is used to monitor queue status by enabling the operator to set up various alarm thresholds such as the Number of calls in queue and Longest waiting call time. A WAV media file can be associated with an alarm for further customization.
- **Park Slots**  
This tab enables the operator to define which park slots are accessible on a system wide basis up to a maximum of 16. The operator is also able to assign which numbers are used to access each park slot and where the slot appears in the park slot panel.
- **BLF Groups**  
This tab allows the operator to create and edit BLF groups.
- **Door Entry**  
This tab allows the operator to configure up to two door entries.
- **Directories**  
This tab enables the operator to choose access to the following directories: SoftConsole local directory, IP Office system directory and Microsoft Outlook contacts. Once chosen, the operator is able to map fields to directory entries.
- **Conferencing**  
This tab allows the operator to set up the names of the two conference rooms. The names will appear on the telephone displays of users in the conference room (maximum of 10 characters).
- **Keyboard Mapping**  
This tab allows the operator to assign keyboard short cut keys for SoftConsole functions.
- **Keyboard Actions**  
This tab allows the operator to specify the default action when alphabetic or numeric characters are pressed.
  - **Alphabetic Keystrokes:** Begin directory search or Open call annotation window
  - **Numeric Keystrokes:** Begin directory search or Open pop-up dial pad
- **Appearance**  
This tab allows the operator to change the appearance of SoftConsole fonts, skins and the call information window color.
- **SoftConsole**  
This tab allows the operator to save the changes made to the configuration of SoftConsole either automatically or manually to a local configuration file on the PC.

---

## SoftConsole Administration

---

SoftConsole has an administration mode that enables the operator to configure the following settings:

- **Control panel views**  
The BLF panel, call history panel, held calls panel and park slot panel can be hidden or made visible.
- **Change the Administrator password**
- **Edit operator profiles**  
Each operator can have a personalized profile, which can be configured by the administrator.
- **Create and modify templates**  
SoftConsole comes with three predefined templates, which can be modified, or new templates can be created.
- **Specify the maximum length of call notes**  
IP Office supports a wide range of different telephone types. These have different display sizes so the operator can define the character length of messages sent to each user according to the type of phone they use.
- **System Tray working**  
The application can be minimized and left running in the system tray so that it can pop on received calls.

### SoftConsole Telephone Requirements

- SoftConsole provides extensive call management, but it still requires an IP Office telephone to provide the speech path. SoftConsole has been tested and is certified to work with all Avaya wired digital and IP telephones that are listed in the ["Telephones"](#) <sup>(107)</sup> chapter.
- SoftConsole cannot be used with IP DECT 3700 Series telephones.



---

## SoftConsole PC Requirements

---

- IP Office software Release 2.0 or later.
- PC requirements:
  - Always refer to the latest Avaya SME Technical Tip or Technical Bulletin for any updated information with regard to Operating Systems, Service Packs or PC hardware.
  - Refer to Technical Specifications section of the Product Description for Operating System and Hardware requirements.
- A maximum of four SoftConsole applications can be run per system. An IP Office license controls the number of simultaneous SoftConsole users.
- SoftConsole requires a SoftConsole license for each user. This license is part of the IP Office Receptionist user license.

# **Chapter 14.**

# **Computer Telephony**

# **Integration**

# 14. Computer Telephony Integration

Computer Telephony Integration (CTI) is about bridging the gap between the telephone system and business applications. On IP Office, this is achieved by use of the IP Office CTI Link, a CTI middleware product and Software Developers Kit.

On IP Office, CTI is delivered through adherence to open standards. This gives businesses access to a wide range of third-party solutions, addressing vertical markets, and designed to meet their requirements. For developers, migrating their offering from other platforms to IP Office is quick and easy, and the advanced CTI features IP Office offers makes it easy to demonstrate full integration, and more business benefits.

IP Office provides two levels of CTI interoperability: CTI Link Lite, which is free of charge, provides all the functionality required to support the vast majority of applications, including screen-popping, and many third-party products.

CTI Link Pro provides enhanced functionality, including the ability to control multiple telephones and gives access to advanced call center operation.

Because IP networking is integrated into the IP Office system, all CTI is done through the LAN. This introduces additional points of failure, as well as relying on non-standard interfaces and handsets. On IP Office, all devices can be used with CTI.

---

## CTI with IP Office

---

IP Office offers a significant CTI capability. Six interfaces are currently supported:

- **TAPILink Lite**  
Provides first-party CTI support for Microsoft TAPI 2.1 and TAPI 3.0, so each PC can control or monitor one phone. The software components are supplied with the IP Office system on the User CD, and do not require a license key for use.
- **TAPILink Pro**  
Provides third-party CTI support for TAPI 2.1 and 3.0. These components are identical to their first-party equivalent; the presence of the CTI Link Pro RFA license key (which can be purchased in the usual way for products) enables this additional functionality.
- **TAPI-WAV driver**  
Provides software-based support for voice processing. The TAPI-WAV driver is for use with TAPI 2.1 only; for TAPI 3.0, IP Office supports the Media Service Provider (MSP) interface, defined by Microsoft in TAPI 3.0. This functionality will only work in conjunction with CTI Link Pro and also requires TAPI WAV licenses. Each license enables 4 ports of voice processing.
- **DevLink Pro**  
Provides a real-time event stream in addition to the SMDR interface provided in IP Office SMDR. The real-time event stream takes the form of a call record, which is issued whenever the state of any endpoint of a call changes (typically there are two end points on a call, but for some circumstances, such as conference calls, intruded calls there may be more).
- **IP Office SMDR**  
Provides an interface to obtain SMDR events. A comma-separated record is issued for each call, when the call is completed. This interface is designed for call accounting and call billing applications. The IP Office SMDR can be output direct from the IP Office control unit to a designated IP address and port.
- **IP Office Software Development Kit**  
This toolkit is delivered on a single CD, containing the developer documentation for TAPILink Lite, TAPILink Pro, DevLink Lite and DevLink pro, as well as pre-compiled programs for exploring TAPI 2.1 and 3.0. In addition, example source code is included, making it easy for developers to become familiar with IP Office CTI interfaces.

---

## TAPILink Lite (1st Party TAPI Support)

---

TAPILink Lite provides simple first-party CTI via Microsoft TAPI 2.1 and 3.0. Individual desktop PCs connected to the Local Area Network communicate with IP Office via an IP connection over the LAN. Each PC is capable of controlling one telephone device (see diagram below).

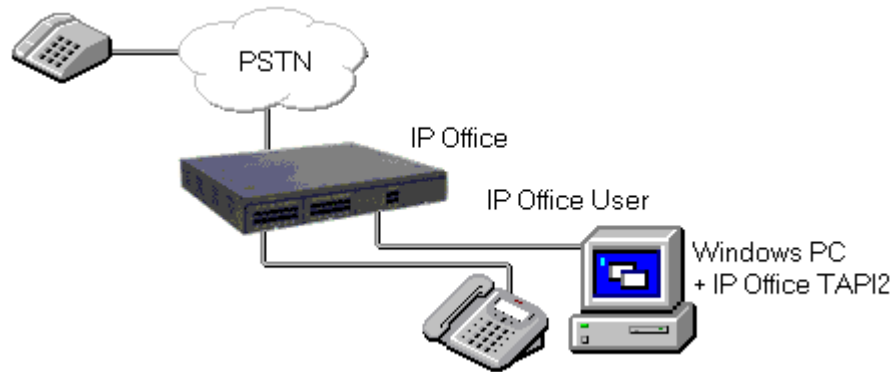

Microsoft TAPI 2.1 and 3.0 are specifications and developers interfaces for controlling and monitoring a telephony device. The specification requires that a certain amount of core functionality is implemented, and additionally defines a series of optional functionality that switch vendors may also implement.

---

## TAPILink Pro (3rd Party TAPI Support)

---

TAPILink Pro provides all of the features and functionality of TAPILink Lite, but additionally provides third party CTI operation. This means that a single server can control and monitor any number of telephone devices.

In addition, TAPILink Pro provides the ability to monitor and control groups. This allows an application to be notified when a call enters a queue, and can also redirect it to another location.

TAPILink Pro also supports additional TAPI functionality that is not available through TAPILink Lite. This functionality is supported through the LineGetLineDevStatus and LineDevSpecific calls. The additional features are:

- Agent login.
- Agent logout.
- Set and retrieve divert destination.
- Set and retrieve extended divert status (Forward All Calls, Forward on Busy, Forward on No Answer, Do not Disturb).
- Retrieving the extension locale (language).
- Set and clear the message waiting lamp.
- Enable and disable group membership.
- Generate and detect DTMF digits and tones (requires the TAPI-WAV driver).

---

## Support for Developers

---

The Developer Connection Program ("DevConnect") is the Avaya developer partner program, and is designed for third-party companies who are creating a product for sale, and who wish to receive technical support. Membership of the program is at the sole discretion of Avaya.

DeveloperConnect members pay an annual fee, for which they receive technical support directly from Avaya. In addition, Avaya will perform interoperability testing between IP Office and the member's product, and may also create opportunities for joint marketing, including exhibitions, use of Avaya's logo, and other benefits.

More information on the DeveloperConnect program can be found at [www.devconnectprogram.com](http://www.devconnectprogram.com).

---

# TAPI Functions Supported by IP Office

---

## TAPI 2.1 Functions Supported

TAPILink Lite provides the following functionality for TAPI 2.1:

- lineAddToConference
- lineAnswer
- lineBlindtransfer
- lineCompleteTransfer
- lineConfigDialog
- lineClose
- lineDeallocateCall
- lineDial
- lineDrop
- lineGetAddressCaps
- lineGetAddressID
- lineGetAddressStatus
- lineGetAppPriority
- lineGetCallInfo
- lineGetCallStatus
- lineGetDevCaps
- lineGetID
- lineGetLineDevStatus
- lineHold
- lineInitialiseEx
- lineMakeCall
- lineNegotiateTAPIVersion
- lineOpen
- linePark
- lineRedirect
- lineRemoveFromConference
- lineSetAppPriority
- lineSetAppSpecific
- lineSetCallPrivilege
- lineSetStatusMessages
- lineSetupTransfer
- lineShutdown
- lineSwapHold
- lineUnhold
- lineUnpark
- lineSetCallData
- lineDevSpecific
- lineGenerateDigits
- lineGenerateTone
- lineMonitorDigits
- lineMonitorTones

---

## TAPI 3.0 functions supported

The following functions are supported using TAPI 3.0:

### **ITTAPI:**

- Initialize
- Shutdown
- EnumerateAddresses
- RegisterCallNotifications
- Put\_EventFilter

### **ITAddress:**

- get\_AddressName
- get\_dialableAddress
- get\_ServiceProviderName
- CreateCall

### **ITMediaSupport:**

- get\_MediaTypes

### **ITCallInfo:**

- get\_Address
- get\_CallState
- get\_CallInfoString
- SetCallInfoBuffer

### **ITBasicCallControl:**

- Connect
- Answer
- Disconnect
- Hold
- SwapHold
- ParkDirect
- Unpark
- BlindTransfer
- Transfer

### **ITCallStateEvent:**

- get\_Cause
- get\_State
- get\_Call

### **ITCallNotificationEvent:**

- get\_Call

### **ITCallInfoChangeEvent:**

- get\_Call

### **ITCallHubEvent:**

- get\_Event
- get\_Call

### **Notes:**

- TAPILink Lite can be used from C, C++ and Delphi. Visual Basic cannot directly use TAPI 2.1, but does support TAPI 3.0 without any third-party tools.
- TAPILink Lite provides detailed information on telephony events, including the ability to screen-pop based on CLI and/or DDI.

---

## Device-Specific Data

The following table shows the device specific data available via TAPI.

- Phone's extension number
- Forward on busy flag
- Forward on no answer flag
- Forward unconditional flag
- Forward hunt group flag
- Do not disturb flag
- Outgoing call bar flag
- Call waiting on flag
- Voicemail on flag
- Voicemail ring-back flag
- Number of voicemail messages
- Number of unread voicemail messages
- Outside call sequence number
- Inside call sequence number
- Ring back sequence number
- No answer timeout period
- Wrap up time period
- Can intrude flag
- Cannot be intruded upon flag
- X directory flag
- Force login flag
- Login code flag
- System phone flag
- Absent message id
- Absent message set flag
- Voicemail email mode
- User's extension number
- Users Locale
- Forward number
- Follow me number
- Absent text
- Do not disturb exception list
- Forward on busy number
- User's priority
- Number of groups the user is a member of
- Number of groups that the user is a member of that are currently outside their time profile
- Number of groups the user is currently disabled from
- Number of groups that the user is a member of that are currently out of service
- Number of groups that the user is a member of that are currently on night service

## DevLink Fields

The following table shows the device specific data available via DevLink.

#	Field Data ( S Message )	#	Field Data ( S Message )
1	A call id	26	Voicemail disallow
2	B call id	27	Sending complete
3	A state	28	Bc.tc,bc.tm
4	B state	29	Owner hunt group name
5	A connected	30	Original hunt group name
6	A is music	31	Original user name
7	B connected	32	Target hunt group name
8	B is music	33	Target user name
9	A name	34	Target RAS name
10	B name	35	Is internal call
11	B list (possible targets for the call)	36	Time stamp
12	A slot ,channel	37	Connected time
13	B slot , channel	38	Ring time
14	Called party presentation and type	39	Connected duration
15	Called party number	40	Ring duration
16	Calling party presentation and type	41	Locale
17	Calling party number	42	Park slot number
18	Called sub address	43	Call waiting
19	Calling sub address	44	Tag
20	Dialled party type	45	Transferring
21	Dialled party number	46	Sv active
22	Keypad type	47	Sv quota used
23	Keypad number	48	Sv quota time
24	Ring attempt count	49	Account code
25	Cause	50	Unique call identifier
#	Field Data ( D Message )	#	Field Data ( A Message )
1	A call id	1	A call id
2	B call id	2	B call id
3	Unique call identifier	3	Unique call identifier



# Chapter 15.

# Messaging

# 15. Messaging

Messaging enables users to manage all of their messages, in particular emails and voicemails, in one place. Since the main messaging platform is typically email, IP Office Preferred Edition enables voicemails to be managed via the email system in order to keep all messages synchronized through one user interface. Essential Edition also enables some basic messaging through the ability to forward voicemail messages to the user's email inbox.

Voicemail in general provides a telephone answering machine with a personalized greeting on every employee's desk and allows callers to leave spoken messages when the user cannot answer a telephone call. Voicemail messages are retrieved either locally or remotely via any telephone (users are prompted for a PIN if they are using any telephone other than their allocated extension or a trusted location e.g. mobile telephone).

The voicemail server is multi-lingual and can offer different prompts depending on the user's preferred language, independently of the default system setup. Similarly, external callers can hear prompts in their own language depending on their incoming call route (e.g. based on caller ID).

Voicemail options available are:

**IP Office Essential Edition:**

- **Embedded Voicemail**

**IP Office Preferred Edition:**

- **Voicemail Pro** – for single site use but use in a Multi-site Networking (SCN) from remote users
- **Distributed Voicemail Pro** – for multi-site use in a Small Community Network (SCN)
- **Centralized INTUITY Audix / Modular Messaging Voicemail** – for use with Avaya Communication Manager

IP Office Preferred Edition is available for Windows and Linux OS. The Preferred Edition on Linux provides the same functionality as described further in this chapter, with the following exceptions:

- Web Voicemail is provided by the user productivity application Avaya one-X™ Portal for IP Office which comes with Office Worker, Teleworker and Power User licenses.
- VPNM
- IVR related actions (Database and VB Scripting)
- Voice Recording Library Authentication (VRLA)

## Positioning Summary

For further details refer to [Voicemail Feature Comparison](#)<sup>[378]</sup> at the end of this section.

Feature	Preferred Edition Voicemail Pro	Essential Edition Embedded Voicemail
<b>Supported IP Office Systems</b>	IP500 V2 IP500	IP500 V2 IP500
<b>Mailboxes</b>	IP Office creates mailboxes for each user and hunt group on the system based on channel licenses	
<b>Message Storage Capacity</b>	1MB per minute up to hard disk capacity	Up to 15 hours.
<b>Maximum Simultaneous Calls</b>	Up to 40 <sup>[1]</sup>	IP500 V2 = Up to 6 <sup>[2]</sup> IP500 = 4
<b>Resilience and Backup</b>	Yes	No
<b>Small Community Network (SCN) centralized operation</b>	Yes	No
<b>Distributed Voicemails in an SCN</b>	Yes	No
<b>Voicemail to email forwarding</b>	Yes	Yes
<b>Unified Messaging (UMS)</b>	Yes	No
<b>Microsoft Exchange Server 2007/2010 Integration</b>	Yes	No
<b>Centralized operation.</b>	Yes	No
<b>Queue Announcements</b>	Yes	Yes
<b>Auto Attendant</b>	Yes	Yes
<b>Call Recording</b>	Yes	No
<b>Intuity Emulation</b>	Yes	Yes

1. Up to 40 in a single-site environment, additional ports can be added in a SCN environment by Distributed Voicemail Pro.

- 
2. The first two ports are included in the basic IP Office system price. Additional 4 ports(sold in pieces of 2) can be purchased and licensed separately.

---

## IP Office Essential Edition - Embedded Voicemail

---

In environments like retail or home office, where space, noise or cost considerations rule out using a PC for voicemail, Embedded Voicemail will be the favored option for an entry-level voicemail service. As built-in functionality of the IP500 and IP500 V2 hardware it requires no separate server. The Embedded Voicemail is enabled by purchasing the IP Office Essential Edition.

Key features of Embedded Voicemail include:

- Up to 6 ports of voicemail on IP500 V2
- IP500 V2: The first 2 ports are included in the basic system. Up to four additional ports can be added simply by purchasing two 2-port add-on license keys
- IP500: Maximum 4 ports of voicemail
- With an increasing number of ports the message storage capacity is increased simultaneously:
  - 2 ports: Up to 15 hours
  - 4 ports: Up to 20 hours
  - 6 ports: Up to 25 hours
- Configurable recording time: Default value 2 minutes, maximum value 3 minutes
- Multiple languages stored on the system
- Help menus via \*4. Greetings and mailbox navigation.
- Send an email containing either notification or the complete voicemail message
- Voicemail breakout/personal auto-attendant: Up to 3 breakout numbers can be set up. When callers are directed to your mailbox, they can either leave a message or choose to be transferred to one of three numbers (e.g. Operator, mobile/cell phone, colleague, etc).
- Configurable system-wide short code for voicemail access (e.g. \*17)
- 40 configurable Auto Attendants with 3 time profile base greetings per Auto Attendant
- Up to 12 menu items per Auto Attendant with automatic time-out to fallback number.
- Auto attendant supports Dial by Name and direct Dial by Number (dial extension number without dialing access digit first)
- Access and control of voicemail via the digital or IP telephone display (Visual Voice). This feature is supported on the 1408, 1416, 1608, 1616, 2410, 2420, 4610, 4620, 4621, 4625, 5410, 5420, 5610, 5620, 5621 and 9600 Series telephones.
- Reply to a message to either an internal or external number (if Caller ID available)
- Support for hunt group announcements
- Fax option for rerouting fax calls via the auto-attendant menu
- Support for Fast Forward (#), Rewind (\*), Skip Message (9) and Call Sender (\*\*) when listening to messages
- No license required

## Support for Intuity Audix Commands

IP Office Basic Edition and Essential Edition voicemail supports Intuity Audix commands in addition to TUI commands. In the Intuity Audix mode, the system uses the same Intuity Audix commands that are currently used on Voicemail Pro. The main reason for introducing the Intuity mode is to provide consistency in the command options across all our messaging solutions.

You have the ability to choose which mode of operation – Intuity mode or IP Office mode – you prefer to use from the IP Office Manager. Some of the commands that are part of the Intuity mode include (but not limited to):

- Press 2 to retrieve messages
- Press 3 to administer your greeting
- Press 5 to change password
- Press \*3 to delete message

The default mode for Basic Edition and Essential Edition messaging is:

- For upgraded systems: no mode change i.e., IP Office mode
- New installs in Partner, Norstar and Quick modes: Intuity mode
- New installs in IP Office: IP Office mode

## Call Screening

When an incoming call arrives at your phone and is then directed to and answered by the voice mail system, you automatically hear the caller on your phone speaker, but the caller cannot hear you. You can decide whether to answer the call or drop from the call and let the voice mail system continue to handle the call.

Call Screening is supported on the following:

- IP500, IP500 V2, and IP Office on Linux platforms
- Basic, Essential and Preferred Editions (centralized and distributed)
- Multi-site networks
- Internal calls targeting a user
- DID calls targeting a user
  - T1, PRI, E1, BRI, SIP
- Transferred calls targeting a user
- Applies to some types of forwarded calls targeting a user
  - Forward On No Answer
  - Forward On Busy
- Outside calls in Basic Mode where call is directed to voice mailbox of a line owner
- Mobile twinning to MyBuddy smartphone application
- Caveats
  - Does not apply to Hunt Group calls
  - Does not apply to Operator or Calling Group
  - Does not apply to page calls
  - Will apply to master in internal twinning and/or to the sending deskphone as part of a mobile twinning relationship

**Note:** Call Screening is also supported by Voicemail Pro.

---

## IP Office Preferred Edition - Voicemail Pro

---

IP Office Voicemail Pro is enabled by the IP Office Preferred Edition and is the most advanced messaging and call flow application for IP Office systems. It can handle up to 40 simultaneous calls depending on license and system settings. Each user has the option of turning their voicemail on or off. When on, the system automatically answers their telephone when they are not available to take a call, plays a personal greeting, and records a message.

When a message has been left, the user will see a message-waiting lamp lit on their telephone and can press a retrieval button to collect their messages.

Voicemail Pro can also ring the user to deliver any new messages. Voicemail messages are time and date stamped and the caller's number recorded. Voicemail Pro can be configured to delete read messages automatically, unless the user chooses to save the message permanently.

Voicemails can be collected remotely by dialing into the Voicemail Pro server. If the number the user is dialing from is recognized (home number or mobile/cell phone for example), the user will listen to their voicemail straight away. If the source number is not recognized, the user will be prompted for a mailbox number and a PIN code for that mailbox, before they can listen to their voicemail. Users have the ability to set and change their own PIN codes.

When a voicemail needs to be forwarded to other users, Voicemail Pro provides many options:

- Voicemails can be forwarded to another mailbox, or group of mailboxes
- Recipients can add their comments to the voicemail before forwarding to another mailbox or mailboxes.
- Voicemails can be forwarded as email WAV attachments.

All options are available in a choice of languages; both spoken voice prompts and graphical programming interfaces and have the choice of IP Office TUI and INTUITY emulation TUI.

### **Voicemail Pro - More than just Voicemail**

Voicemail Pro offers much more than just a pure voicemail system. Other helpful, convenient, cost and time saving options are:

- Whisper Announce that prompts callers for information (usually their name) which is recorded and passed on to the user's extension on answer, allowing them to choose to accept the call or not. This is particularly useful on "CLI/ANI withheld" numbers - usually calls from telesales companies where somebody is trying to sell you something. Voicemail Pro will not intrude onto busy extensions.
- Assisted Transfer allows transfer of a call to a destination, but allows the call to return to Voicemail Pro automatically for other options should the called party be engaged, or not answer within a pre-determined time.
- Conditional routing of calls. Conditions are constructed from a set of basic elements. These elements can be combined within a single condition to create complex rules. For example, the Week Planner can be used to define the company's standard working hours, and then combined with the calendar to define exception days such as public holidays / vacation.
- Call modules. Modules allow you to create sequences of actions that you want to share between a number of different call routing scenarios - like a "macro" in PC applications. These modules can be used to create a library of vertical voicemail applications or just easy dissemination to other IP Office voicemail sites, thanks to its import and export functionality.
- Activation of the external relays on the IP Office system. For example, remotely checking the status of the office meeting and then turning it on from your mobile/cell phone on your drive in to work.

## Key Features

Key features of Voicemail Pro include:

- Personal voice mailbox for users and hunt groups.
- Personal Numbering (follow me).
- Extended personal greetings to customize the information presented to a caller based upon the availability of a user.
- Unified Messaging (UMS) offers voice mail - email synchronization between the Voicemail Pro server and the email client.
- UMS Web Access allows access to voice mails via a web interface from an internet browser.
- UMS integration of Voicemail Pro with Microsoft Exchange Server for full message synchronization.
- Enables mobile messaging integration (e.g., Blackberry) when used with Exchange server integration.
- Forwarding of voicemail messages to email systems via SMTP.
- Voicemail Pro client, a graphical user interface for programming and configuring applications both locally and remotely.
- Data base access via Interactive Voice Response (IVR) for individual business requirements.
- Audiotex and Auto Attendant services (including dial by name).
- Sophisticated queue announcement facilities.
- Access and control of voicemail via the digital or IP phone display (Visual Voice).
- 22 supported prompt languages: Chinese (Mandarin), Danish, Dutch, English (UK), English (US), Finnish, French (France), French (Canadian), German, Greek, Hungarian, Italian, Korean, Norwegian, Polish, Portuguese (European), Portuguese (Brazilian), Russian, Spanish (Castilian), Spanish (Latin American), Swedish.
- Conditions (e.g. test if 'out of hours').
- Broadcast group messages.
- Automatic and on demand call recording with an option for ContactStore search and replay of saved messages.
- Tampering Detection / Verified Call Recording
- Voice forms/questionnaire mailboxes (Campaign Manager).
- Personal distribution lists.
- Tag information retrieved from a database to a call and delivers it with the call to an agent.
- Visual Basic (VB) Script support to allow the configuration of the voicemail system through VB scripts rather than Voicemail Pro call flows.
- Text-to-Speech facilities to allow emails to be read out over the telephone and/or for database information to be read to a caller in 14 languages.
- Housekeeping facilities for the management of messages.
- Automatic detection and routing of fax calls within Auto Attendants and within a subscriber's voicemail box.
- Support for a range of the INTUITY telephone user interface features in INTUITY emulation mode.
- Recording of system prompts through the telephone handset or using multimedia facilities on a PC.
- Speaking clock.
- Support for TTY hearing impaired text phone.
- Centralized VoiceMail within a multi-site IP Office environment.
- Networked Messaging with other Avaya voicemail systems and voice messaging systems supporting VPIM (like CallPilot).
- Capacity of up to 40 ports for a single-site system.
- Voicemail channels between Voicemail Pro and the IP Office can be reserved for business critical functions or left unreserved for any function.
- Improved voice recording, including recording of calls made over IP telephones (calls using direct media has to be routed through IP Office); automatic call recording triggered by incoming call routes; pausing recording when call is parked or placed on hold.

- User start points in Voicemail Pro include queued options.

Further details on some of the Voicemail Pro functionality listed above are described later in this section.



## **Call Flows with Voicemail Pro for Intelligent Call Handling**

At the heart of Voicemail Pro is the ability to construct call flows from a series of different building blocks. These building blocks allow automation over tasks like answer a call, listen for tone-dialed digits, make a call etc. Voicemail Pro call flows allow far more than just guiding a user to the group or extension they require. Call flows allow Voicemail Pro to dial back users as soon as a voicemail message is left for them, it provides remote access to phone forwarding settings should a user wish to change their Forwarding or Follow Me number from an external telephone. Voicemail Pro provides message handling for individuals or groups, audio information to callers so assisting the operator during periods of heavy call activity and links to business applications through services such as Text-to-Speech. Voicemail Pro provides a full telephony applications environment where call flows can be set up and interact in real time with business workflow – callers can interact via menus and data entry and Voicemail Pro applications can speak back results. For example, users can listen to their email messages through the telephone.

## **Email Integration**

Integration with email systems is provided by the Voicemail Pro Unified Messaging Service (UMS) which is delivered to eligible users as part of the Office Worker, Teleworker or Power User license. It enables Voicemail Pro to interact with email systems to provide a synchronization of voicemails and their status (new/unread, read, deleted, saved) between all user devices like desk telephones, mobile cell telephones, the UMS web interface, Avaya one-X™ Portal for IP Office, the email client and other devices that are synchronized with the user's email account. This will work for email clients that use the IMAP4 protocol (like MS Outlook, Lotus Notes, Mozilla Thunderbird, and many others).

## **Voicemail Pro and Exchange Server**

Advanced collaboration between Voicemail Pro and Microsoft Exchange Server offers voicemail storage into the Exchange message store. This is the single point of storage for all email and voicemail messages and therefore the single source for all message status information. When a voicemail should be collected using a desk phone connected to the IP Office, Voicemail Pro retrieves it directly from the Exchange message store. Voicemail Pro sends the voicemails not just as emails with a .WAV attachment but as a message formatted as 'voicemail' so that Exchange can handle them differently from emails.

If Microsoft Exchange Server working with a mobility solution server (e.g., a Blackberry Enterprise Server) are used to push emails to mobile devices (Blackberry or similar), Voicemail Pro also integrates and delivers voicemails via the Exchange Server to the mobility solution. The mobile device is then able to present voicemails on the visual voicemail interface (instead of presenting them as emails with an attachment).

## **Voicemail in a Small Community Network (SCN)**

A single PC based Voicemail Pro server can provide voicemail services to multiple IP Office systems in a Small Community Network over the LAN, WAN or a Frame Relay network. This is referred to as 'Centralized Voicemail' and can reduce costs, while facilitating communication between IP Office sites. For resilience, should the main site fail, the Centralized Voicemail will automatically reconnect to an alternative IP Office site.

For voicemail connections from remote IP Office users in a SCN no multi-site channels are needed.

## IP Office Preferred Edition - Voicemail Pro Resilience and Backup

Customer service with uninterrupted access to the business is essential – for customers who want to place orders, for partners who want to negotiate an important contract and for employees who need access to their important messages. A failure can be very expensive for a business and there are a number of reasons why a failure can happen: power outage, lost network connection, cable cuts, hardware failure, and so on.

But loss of money and reputation does not necessarily have to follow such a failure. The IP Office Resilience and Backup functionalities are supported by Voicemail Pro. A Voicemail Pro server, connected to a Primary IP Office, can automatically re-connect to a Backup IP Office if the connection between the two IP Office systems gets lost. This covers the failure of an IP Office or the connection between them. A Preferred Edition license is required on the backup IP Office system for this scenario.

Introduced with Release 6, a Backup Voicemail Pro server offers additional comprehensive functionalities to keep the business communication up and running. A Backup Voicemail Pro server can be added to an IP Office / Voicemail Pro system to take over the voicemail functions in the case of a failure at the primary Voicemail Pro system.

The Backup Voicemail Pro server can act in different scenarios:

- One IP Office, one Primary Voicemail Pro server, and one Backup Voicemail Pro server, where the backup is either at the same location as the IP Office / Voicemail Pro or at an external site
- A Primary IP Office with a Primary Voicemail Pro server and a Backup IP Office with a Backup Voicemail Pro server at a second location
- A Multi Site Network with a Centralized Voicemail Pro server connected to an IP Office at one site and a networked IP Office with a Backup Voicemail Pro server. There might also be additional IP Office and Distributed VoiceMail systems within that Multi Site Network.

The diagram illustrates the second scenario:

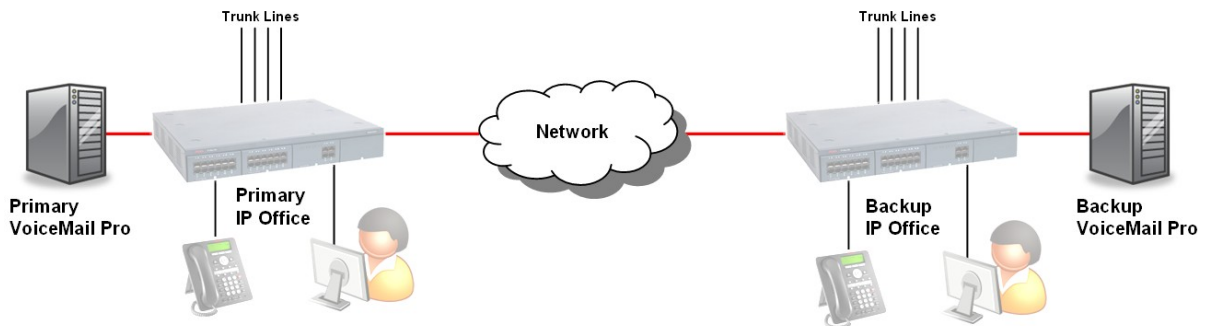

The Primary Voicemail Pro will establish a link to the Backup Voicemail Pro and keep the greetings and configuration setting changes synchronized with the Primary Voicemail Pro. Messages and message states are not synchronized between the Primary and the Backup Voicemail Pro to avoid network overload.

Ideally the Backup Voicemail Pro server is a mirror system of the Primary Voicemail Pro server with all its capabilities, like the number of ports, licensed features, and hardware. All required functions have to be licensed through IP Office Preferred Edition and supported by adequate hardware (e.g. to ensure server performance and sufficient IP Office trunk lines). The 2 hour run-time of a Voicemail Pro server without licenses does not apply to a backup scenario.

The Backup Voicemail Pro server can have limited functionalities (e.g. fewer number of ports) if it is acceptable to have limited capabilities for a limited period until the re-connection of the main server.

## Distributed Messaging

One Centralized Voicemail Pro server is supported in a SCN of multiple IP Office systems with IP Office / Voicemail Pro Release 5 and earlier. IP Office R6 allows multiple Distributed Voicemail Pro servers to be placed at selected or all of the IP Office nodes.

Into one Multi Site Network there can be one Centralized Voicemail Pro, one Backup Voicemail Pro (as a backup for the Centralized Voicemail Pro), and up to 30 Distributed Voicemail Pro (theoretical value). The Centralized Voicemail Proserver will keep its role as the main voicemail server. It provides the media store for voicemails left on the system, as well as the media services required on the Multi Site Network to IP Offices not supported by a local Voicemail Pro server.

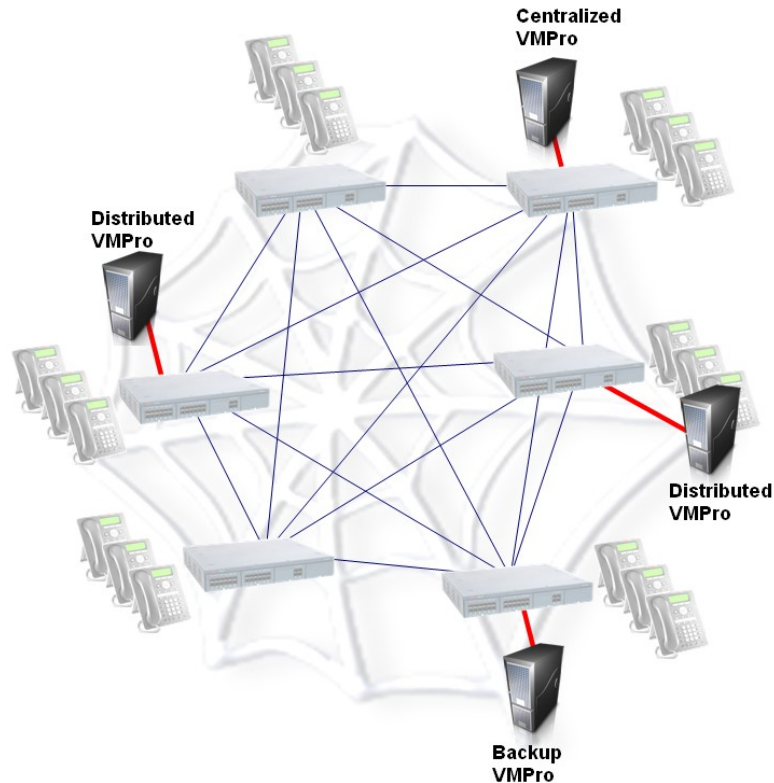

The retrieval of voicemails will require access to the Centralized Voicemail Pro, while other voice resources will be available locally, providing local capabilities for queuing announcements, call recordings, auto attendants and leaving of voicemails.

On failure of a Distributed Voicemail Pro, the Centralized Voicemail Pro will be used for all functions as if no Distributed Voicemail Pro servers were present.

Centralized Voicemail Pro, Distributed VoiceMail, or Backup VoiceMail require the same Preferred Edition license but will be configured differently in IP Office Manager according to the required function.

## International Time Zone Support

International Time Zone support in Preferred Edition gives the customers with a multi-site environment (IP Office SCN network) in different time zones the ability to get the right time stamps for voicemails and announcements for the local time zone of the IP Office switch they are connected to.

- Each personal voicemail recording will have the timestamp of the local switch
- Each announcement e.g. opening times will have the timestamp of the local switch

The feature works in a Distributed/Backup Preferred Edition scenario in the same way. The feature also works in the same way for voice messages delivered to the hunt-groups.

The following Preferred Edition features are affected by the ITZ feature as described above:

- Alarm Set
- Call Answering (Users and Hunt Groups)
- Call Recording
- Campaigns
- Clock Action
- Distribution List
- Incoming VPNM
- Outcalling
- Week Planner Action
- Email reading

**Example:** Consider a setup where IP Office time is 14:00 (UTC + 2:00) and the corresponding VM Pro server is in a different time zone (UTC + 5:30). A user on IP Office sets an alarm for 14:30. The IP Office system will trigger the alarm when the time on the IP Office is 14:30 and not when the time on the VM Pro server is 14:30.

# Interaction of Voicemail with Email Systems

As standard, Voicemail Pro allows for a simple voicemail alert where the entire voicemail is forwarded (copied) as a .WAV attachment to any MAPI or SMTP compliant email application (Microsoft Outlook, Exchange, Lotus Notes, etc.). Forwarding allows emails and voicemail messages to be unified and collected from a single source. This simple alert option that forwards only the caller's number in the subject of the email is ideal for use with commercial Short Message Systems (SMS). This information can be forwarded to the display of a mobile/cell phone when the user is away from the desk. The email notification, forwarding and copying, can be done for all voice messages and can be activated remotely. This is beneficial if you are working from home and have an email connection available.

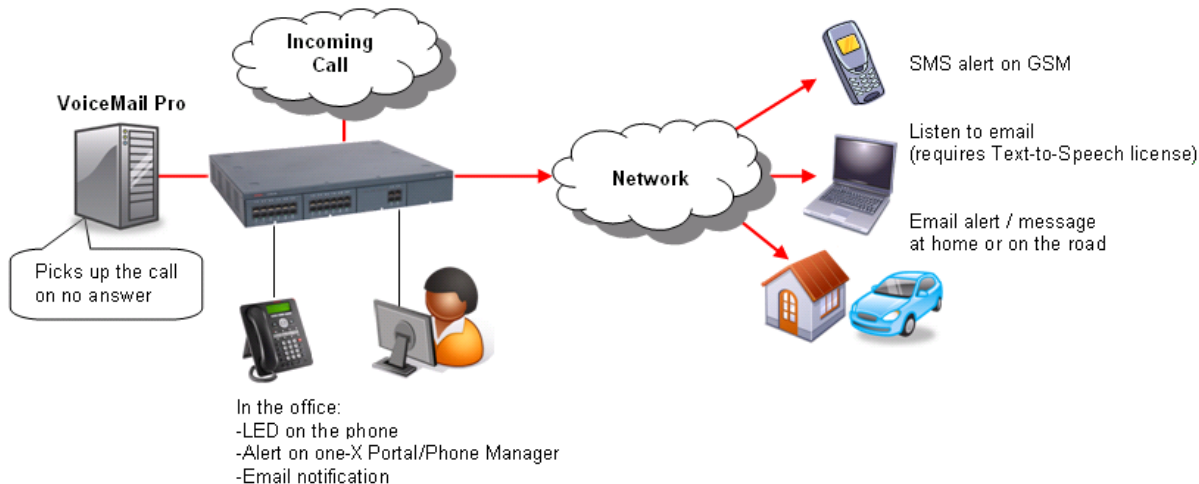

Forwarding voicemail to email is particularly useful for group voicemail boxes as it allows a single voicemail message to be copied to the email of every member in that group.

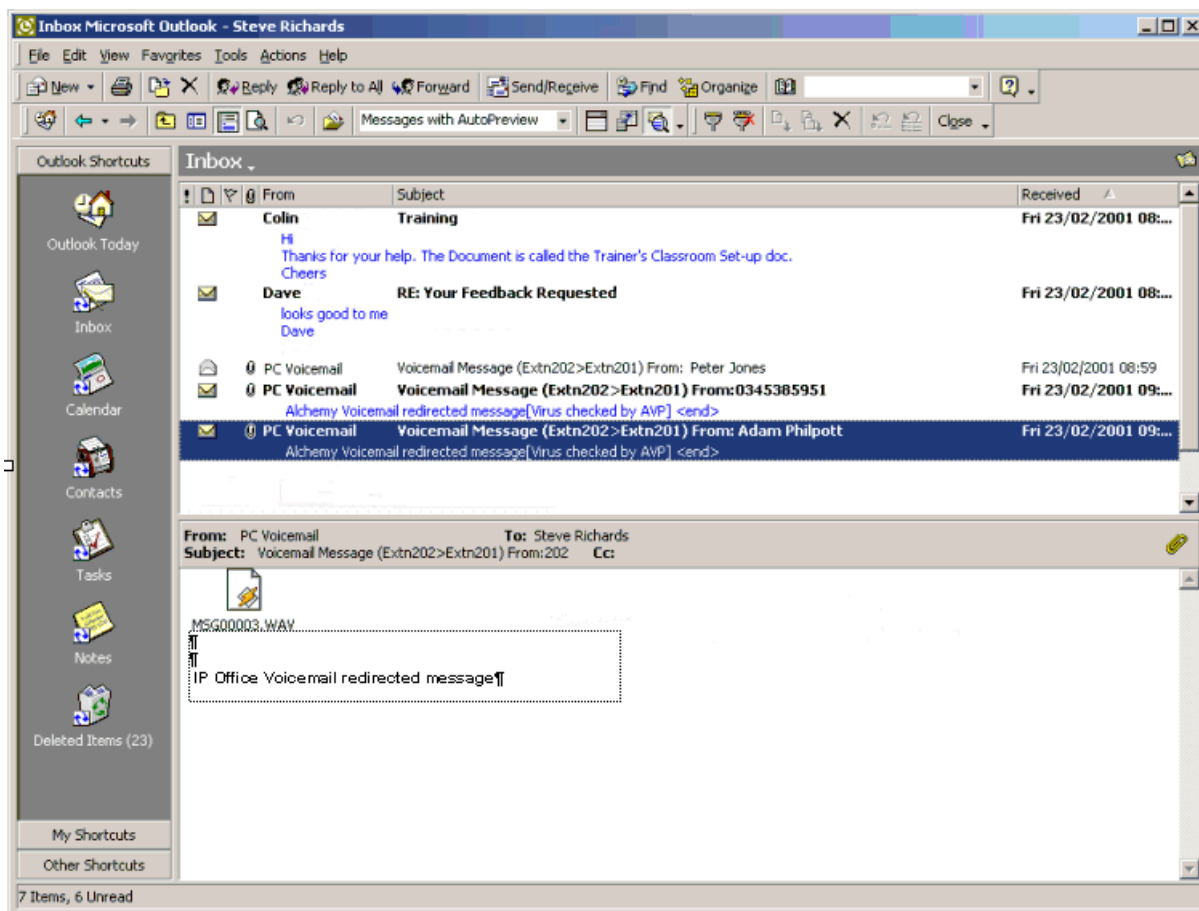

# Unified Messaging Service (UMS)

Unified Messaging Service (UMS) provides the integration of Voicemail Pro with email systems. A very simple installation and configuration process enables users to manage their voicemail messages by using the device of their choice including email clients or mobile devices. UMS is licensed on a per-user basis as part of the IP Office Power User, Teleworker and Office Worker license.

Depending on the existing infrastructure UMS can be integrated with IMAP-based email solutions as well as with Microsoft Exchange Server environments.

## Voicemail Synchronization via IMAP

Email applications such as Outlook which support IMAP can connect to an IMAP server integrated with the Voicemail Pro server.

Voicemail Pro will deliver new voicemail messages by using the voicemail to email capability.

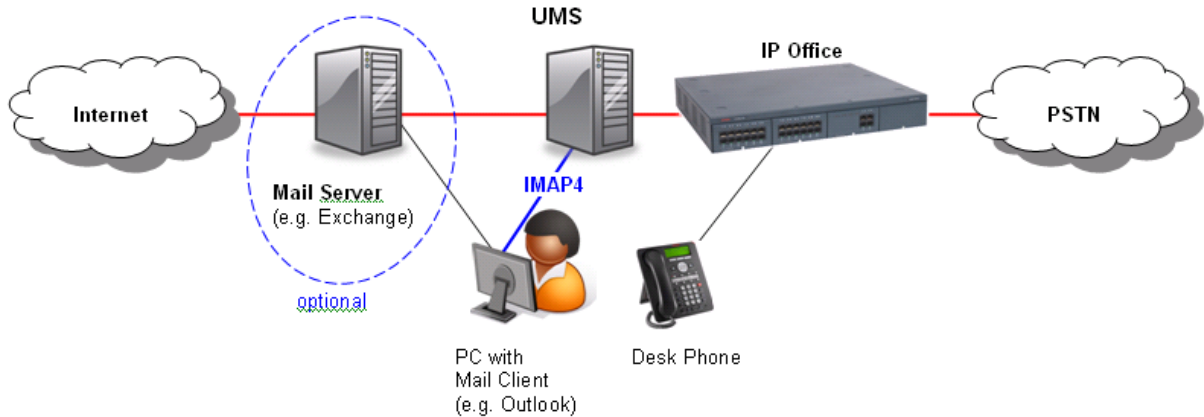

New voicemails arrive as emails with a .WAV attachment and the user can handle them like any other email. If a voicemail has been listened to, its status will change to "read", independent of the device that has been used to access the voicemail. If the user deletes it, it will be deleted everywhere.

Users that have UMS access enabled just need to add an additional email account to their email client to be able to use the unified messaging features. No additional client software installation is required.

The instructions how to add this account and configure the web address for the Voicemail Pro Web Access can be provided by an administrator by email without the need for system administration or external support.

## Voicemail Pro UMS Web Access

The second interface UMS offers to the users is a web interface allowing voicemail access via a web browser, such as Internet Explorer or Mozilla Firefox, with the ability to listen to targeted voicemails by using either the PC's multimedia equipment or the desk phone.

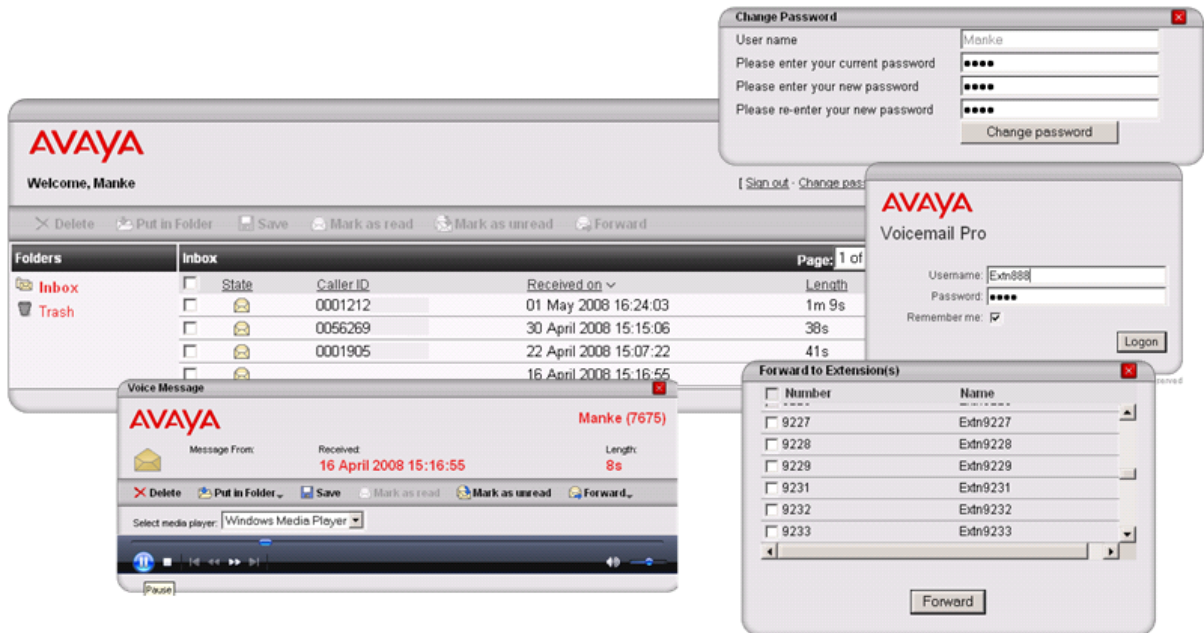

UMS Web Access requires the Voicemail Pro installation to be on a server with IIS pre-installed. In addition, the Voicemail Pro UMS Web Access option must be selected during installation.

Once installed, the system will require the following additional configuration:

- IP Office Power User, Teleworker and Office Worker licenses (for the number of users that will be configured to use UMS).
- Users selected for UMS support must be enabled by the system administrator in IP Office Manager.
- Each user must have a voicemail PIN code (a blank PIN is not acceptable).

## Support for Internet Explorer 9 and Firefox 5

Preferred Edition thin clients - WebVoicemail and WebCampaign is supported on the latest versions of the following browsers:

- Internet Explorer 9
- Firefox 5

The minimum level of support offered for browsers with the above clients are:

- Internet Explorer 8
- Firefox 3 (Web Voicemail only)
- Opera 10 (Web Voicemail only)

Customers using older browsers should upgrade to a more recent version but Preferred Edition will not prevent usage on the older browsers.

## Integration with Microsoft Exchange Server

As part of UMS, Voicemail Pro can integrate with the Exchange Server from Microsoft. Each user with UMS enabled can be configured to use either the IMAP capability (see above) or the Exchange integration. If the Exchange option is selected, all user voicemails are forwarded and stored in the Exchange server message store instead of the Voicemail Pro message store. Voicemail Pro is able to deliver new voicemails to Exchange formatted as 'voicemail' which enables Exchange to handle them differently from standard emails. If used in combination with a mobility solution voicemails can be managed using the visual voicemail user interface of the mobile device (e.g. Blackberry).

The following diagram illustrates the two possible ways of integrating with either a standard IMAP-based email system or with an Exchange Server email system.

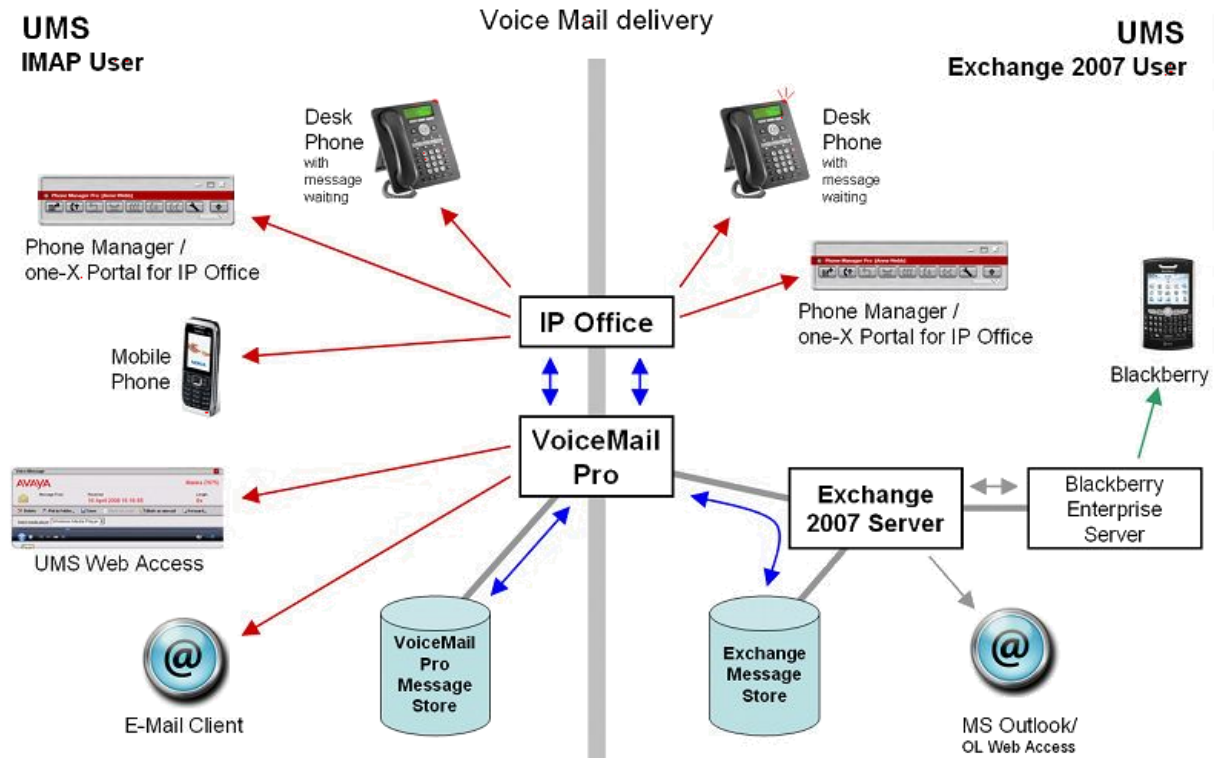

Both scenarios can exist in parallel on the same system but only one option can be configured for one user.

A voicemail stored in the Exchange message store can be retrieved by Voicemail Pro and made accessible for all communication devices (as shown in the diagram above).

Earlier versions of Microsoft Exchange Server are supported by using the IMAP integration described above.



---

## Fax Messages

---

Integration with fax software, integration with fax to the desktop or client fax applications can be realized through the use of fax servers. This allows an email client (for example Microsoft Outlook) to be utilized as an easily affordable unified messaging solution. The many benefits of unified messaging include security (as faxes are sent to the user's PC rather than on paper for everyone to see), ease-of-use and efficiency in terms of storage and retrieval of messages and the great gains that can be made in overall workforce efficiency and productivity.

To enhance the support of third party fax solutions, Voicemail Pro supports the automatic detection of incoming fax calls. Traditionally a dedicated telephone number is provided for all incoming fax calls. In addition to, or as an alternative to, the Voicemail Pro 'Menu' action or a subscriber's voicemail box (INTUITY mode) can automatically detect any incoming fax calls and then direct the call to a predefined location. The benefit to a business or user is that only one number is required for either voice or fax calls.

The Voicemail Pro can store the default fax location for the automatic routing of fax calls. Alternatively, with fax tone detection at the voicemail box, each voicemail box can have a fax location number. If a voicemail box owner has set his or her own fax number, then that number is used instead of the default fax location.

Voicemail box subscribers can set their own fax number through their mailbox menus.

Most fax solutions can be used in conjunction with IP Office; however the following products have been tested and verified to operate in the above scenarios:

- **Equisys - Zetafax**  
Zetafax for Networks provides versatile network fax software solutions for small businesses, corporate offices and distributed enterprise businesses. It enables employees to send and receive faxes at their desktop, without the need to print fax communications, take them to a fax machine and send them manually. Zetafax can be seamlessly integrated into market leading email systems like Exchange allowing users to send and receive faxes directly from their Outlook client. In addition Zetafax can be integrated with other existing applications, such as accounting or CRM systems, for fast, automated faxing from the desktop or back office. Further product information available from [www.equisys.com](http://www.equisys.com).
- **Open Text Fax Server (formerly Captaris – RightFax)**  
RightFax offers a broad, scalable product line that integrates with email, desktop, CRM, ERP, document management, imaging, archival, call center, copier/scanner systems, as well as host, legacy and mainframe applications—virtually all business applications. Further product information available from [www.captaris.com](http://www.captaris.com).
- **Fenestrae – Faxination**  
Fenestrae Faxination Server for Microsoft Exchange integrates fax into email technology. Create faxes on your desktop and deliver them to your chosen fax machine at the click of a mouse. Further product information available from [www.fenestrae.com](http://www.fenestrae.com).
- **GFI – GFI FaxMaker**  
GFI FaxMaker for Exchange/SMTP allows users to send and receive faxes and SMS/text messages directly from their email client. It integrates with Active Directory and therefore does not require the administration of a separate fax user database. GFI FAXmaker integrates via the SMTP/POP3 protocol with Lotus Notes and any SMTP/POP3 server. Further product information available from [www.qfi.com](http://www.qfi.com).
- **Open Text Fax Appliance (formerly Castelle FaxPress)**  
Faxes routed to a user's mailbox by this fax server will be recognized by Voicemail Pro as faxes, and will be supported by Voicemail Pro Fax features. More information is available from [www.castelle.com](http://www.castelle.com).

---

## Text-to-Speech Email Reading (Microsoft Exchange only)

---

In addition to providing a unified mailbox for voicemail messages, emails and fax message, Voicemail Pro can also provide the ability to retrieve email messages through the telephone.

When operating in INTUITY mode and with Power Users and/or Mobile Workers licensed these users will be presented with a list of both voicemail messages and email messages. The emails can then be read out over the telephone. The benefit to the user is that their messages are now accessible while in and out of the office through any telephone. The user's email account needs to be configured in IP Office manager to enable TTS functionality.

When accessing messages through the telephone all new voicemail messages will be presented to the mailbox owner before any new email messages. When accessing an email message the system refers to the message as "*New message with text*".

Emails will be read based on the user language setting in IP Office, depending on the TTS engine capability. With no additional TTS engine installed Voicemail Pro TTS will use the TTS engine installed with the Microsoft Windows operating system. If using Avaya TTS, then 22 languages are supported on Windows and 19 are supported on Linux. If using 3<sup>rd</sup> party TTS please refer to the vendor documentation for supported languages. Avaya TTS is an optional license.

Where the user has email reading in their voicemail box, they will be able to record a voice reply to the email, and send it as a .WAV attachment to a reply email to the person who sent the email.

**Note:** More than eight users can use TTS functionality if the Avaya TTS ScanSoft or Avaya TTS Professional license are purchased. Avaya TTS will only work on Linux with the TTS Professional license.

## Networked Messaging

Where organizations are operating a number of voicemail systems across different sites it is important to be able to provide integrated operation between voicemail systems so that messages can be passed between systems and delivered to a user's mailbox seamlessly. This is achieved by IP Office Voicemail Pro being licensed to support Networked Messaging.

The Networked Messaging solution defines a common set of features to allow inter-working between Avaya voicemail systems. In INTUITY mode, while listening to or having listened to a message, the user can select the option to forward the message to another mailbox, the mailbox entered can be any mailbox number on the local system or any mailbox on a remote Avaya system.

The IP Office Networked Messaging facility will allow configuration of up to 2000 remote mailboxes on each Voicemail Pro server and will operate with other IP Office systems supporting this feature, as well as with Avaya Enterprise solutions.

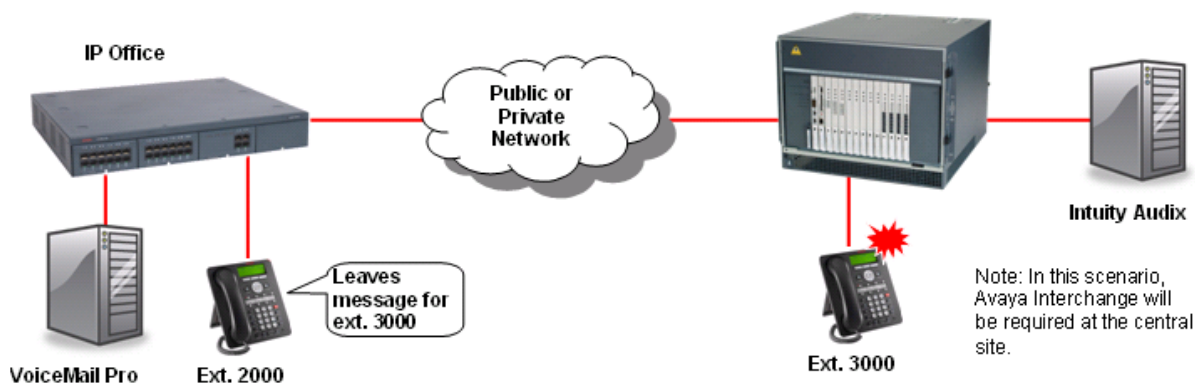

# Auto Attendant

Voicemail Pro provides an easy-to-use, multi-level configuration tool (the Voicemail Pro client) which allows network managers and system administrators to construct an interactive menu system, based upon DTMF telephone key entry. This allows an Auto-Attendant system to be built and configured to suit business needs, be that on its own or as a back-up for the regular operator when call volumes are high. Voicemail Pro offers the caller the ability to dial the name of a person via the phone keypad (like "Text" messaging on mobile cell telephones). In response the Auto-Attendant offers the caller a best match name or if there is more than one, a selection list is offered and the caller can select which one they want to call.

As an example, Voicemail Pro can be used to build an Auto-Attendant that prompts callers to "enter 1 for sales, 2 for support, 3 for admin, or 0 for the operator" allowing them to be transferred to the appropriate department without operator intervention. Alternatively, a list of personnel and their extension numbers could be listed, allowing the caller to directly access the person they want. For larger companies it could be department name listed first, followed by the list of employee extensions within the department.

The latter two examples are ideal where company telephone operation has changed from a central operator to direct dialing (DDI/DID), allowing callers to "learn" the required extension number from the prompting of Voicemail Pro, and then in future dial the extension number, or other pre-defined variables, directly. Auto-Attendant operation is also ideal where multiple languages are required, for example "Dial 1 for English, 2 for German, 3 for French, ...".

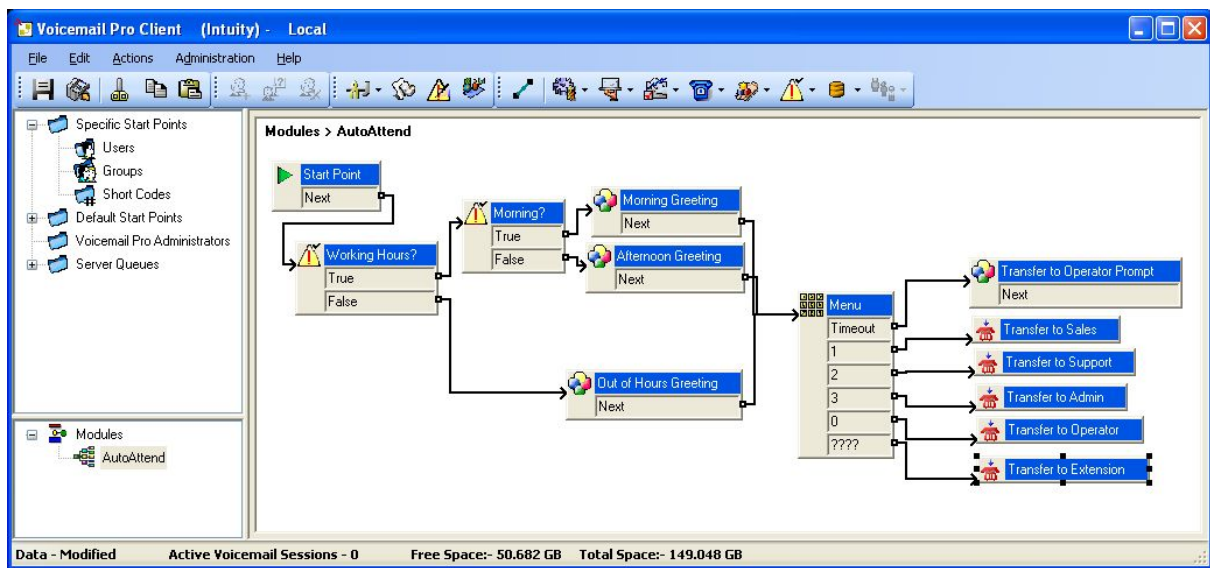

Auto-Attendant created using Voicemail Pro Client

---

## Personal Numbering

---

Contact-ability is all-important in winning and maintaining business. Voicemail Pro offers users the ability to remotely turn their voicemail on or off, set their voicemail email forwarding, edit their call forwarding and follow me numbers. Together these actions provide a comprehensive Personal Numbering service for the user who needs to remain in contact regardless of their physical location.

Users with Mobile Twinning configured are able to remotely activate their twinning capabilities through Voicemail Pro call flow.

# Accessing Database Information within Call Flows (IVR)

Voicemail Pro provides the ability to construct powerful interactive systems based upon DTMF telephone key entry. This is achieved by using the flexibility provided from the built-in call flow actions. As a caller passes through any part of a defined call flow the system is capable of interacting with most third party databases using the standards based ADO interface (ActiveX Data Objects). The system is capable of retrieving information from a database and writing information into databases. The result of this is that powerful Interactive Voice Response systems (IVR) can be delivered to specifically meet the requirements of the business and the customer experience that is required.

Example interactive systems that can be built as a result of these facilities include: Information bulletin boards, order taking and order processing systems, front end systems to help desks/support desks, contact centers, secure access to information through PIN checking, survey systems, remote time sheet management, etc.

The ability to interact with database information is enabled through the purchase of the IP Office Advanced Edition. The Voicemail Pro Client supports four Database Action Icons, which can be implemented into the Voicemail Pro call flows. The entry of the IP Office Advanced Edition license will enable the Voicemail Pro server to use these actions in call flows.

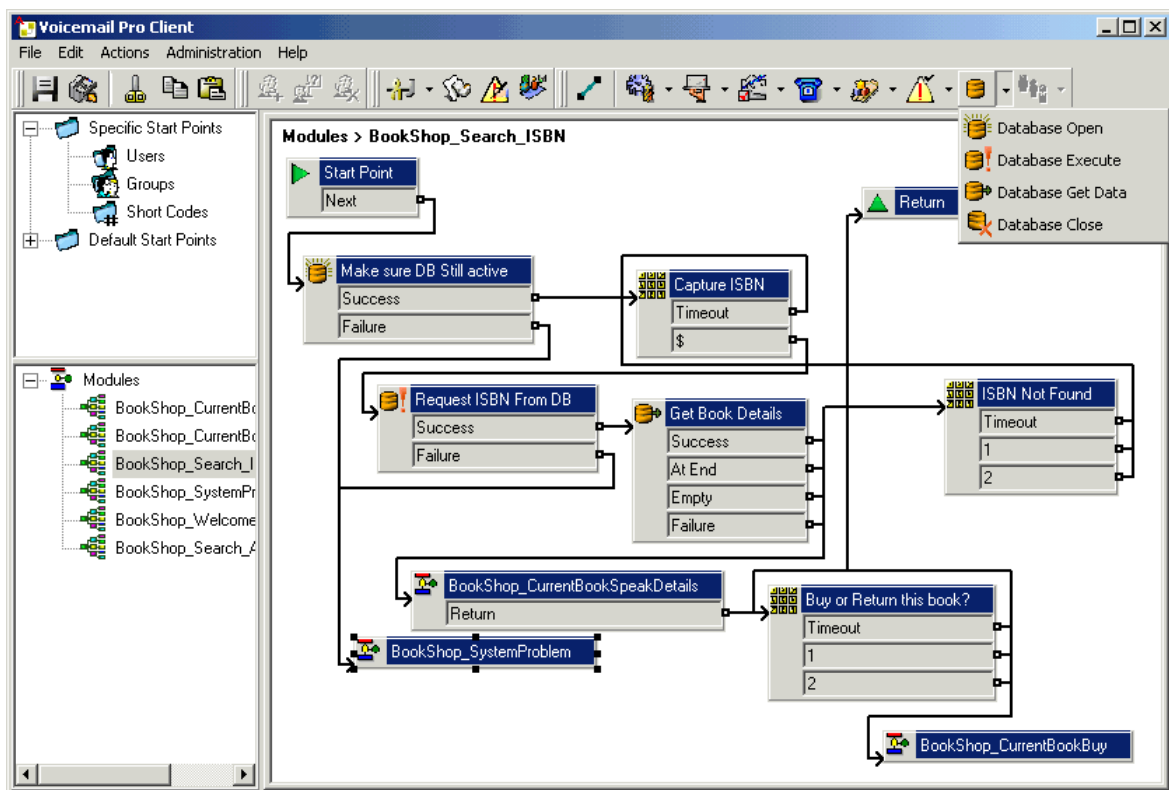

Example Call Flow Utilizing Database Actions

The database actions that are provided through the Voicemail Pro Client are:

- Database Open – Opens a link to the required database. Multiple databases can be accessed during a call but only one database can be opened at one time.
- Database Execute – Provides the ability to enter a query on the opened database. The query can 'Select' data from the open database or can 'Insert' data into the database.
- Database Get Data – Provides access to the data that has been retrieved from a database through the Database Execute action. The user can retrieve the next item, previous item, first item in the list or the last item in the list.
- Database Close – This action will close the current database. If the database is open when a call terminates then the database will be automatically closed.

Interaction with the opened database is done through Structured Query Language scripts (SQL). An administrator can enter SQL script directly into the specific section of the Database Execute action. For administrators that are not familiar with SQL scripts, a script can be created automatically through the use of a SQL Query Builder Wizard.

---

## Using Text To Speech (TTS) Facilities within a Call Flow

---

Text-to-Speech (TTS) can be used to further enhance IP Office IVR and call flow capabilities; TTS facilities can enhance the callers experience by allowing the system to read back to them any information that has been extracted from a database. For example, in a book shop, the caller dials into the system and is asked for an ISBN number of the book they require. The caller enters the ISBN through the telephone keypad and the system locates the title of the book from the database. As well as finding the title, the system could also look up the author of the book and whether there were any books in stock. By using TTS, the system could now respond to the call:

*"The book, Lord Of The Rings, costing \$6.99, written by J R R Tolkien is in stock".*

From Voicemail Pro Release 6 onwards it is also possible to use Text-to-Speech within call flows or auto attendants for announcements. A call flow / auto attendant can be enabled to read text that has been created by call flow actions and offers much more flexibility because there is no longer the need for pre-recorded and static announcements. If there is a change to an announcement the call flow action will create the new announcement and will play it to the caller.

The IP Office Advanced Edition contains 8-port 3<sup>rd</sup> party Text-to-Speech capability and can be used either with a TTS engine that has to be purchased separately or - when no 3<sup>rd</sup> party engine is installed - with the Microsoft TTS engine which is part of the Windows operating system.

An alternative is the Avaya TTS license (independent licenses for Windows and Linux) which adds a TTS engine available in 22 different languages on Windows and 19 different languages on Linux:

- Chinese (Mandarin)
- Chinese (Cantonese) - not on Linux
- Danish
- Dutch
- English (UK)
- English (US)
- Finnish
- French (Standard)
- German
- Greek
- Japanese - not on Linux
- Italian
- Korean - not on Linux
- Norwegian
- Polish
- Portuguese
- Portuguese (Brazilian)
- Russian
- Spanish
- Spanish (Latin)
- Swedish

The Avaya TTS is a per-port license.

The total number of TTS ports on each Voicemail Pro system is limited to eight. On a single or Centralized Voicemail Pro, up to eight concurrent ports can be used for IVR and email reading, on a distributed Voicemail Pro up to eight ports can be used for IVR.

When using the ScanSoft and Professional license, the maximum number of ports is 40.

# Visual Basic (VB) Scripting

The Voicemail Pro call flow programming interface allows an administrator to provide Visual Basic (VB) scripted logic that can be interpreted by the Voicemail Pro server. This ability enables system administrators to program the voice system via VB Scripts thus providing additional choice and flexibility in providing IVR applications. The VB script action contains a VB-Scripting parser (Syntax checker) to ensure the legitimacy of the administrator derived VB Script before its incorporation. Each VB script action used within a call flow can contain a maximum of 10,000 characters; however a call flow may contain multiple VB script actions within it.

On a right mouse click in the VB Script window the methods and variables available will be listed to assist when constructing call flows.

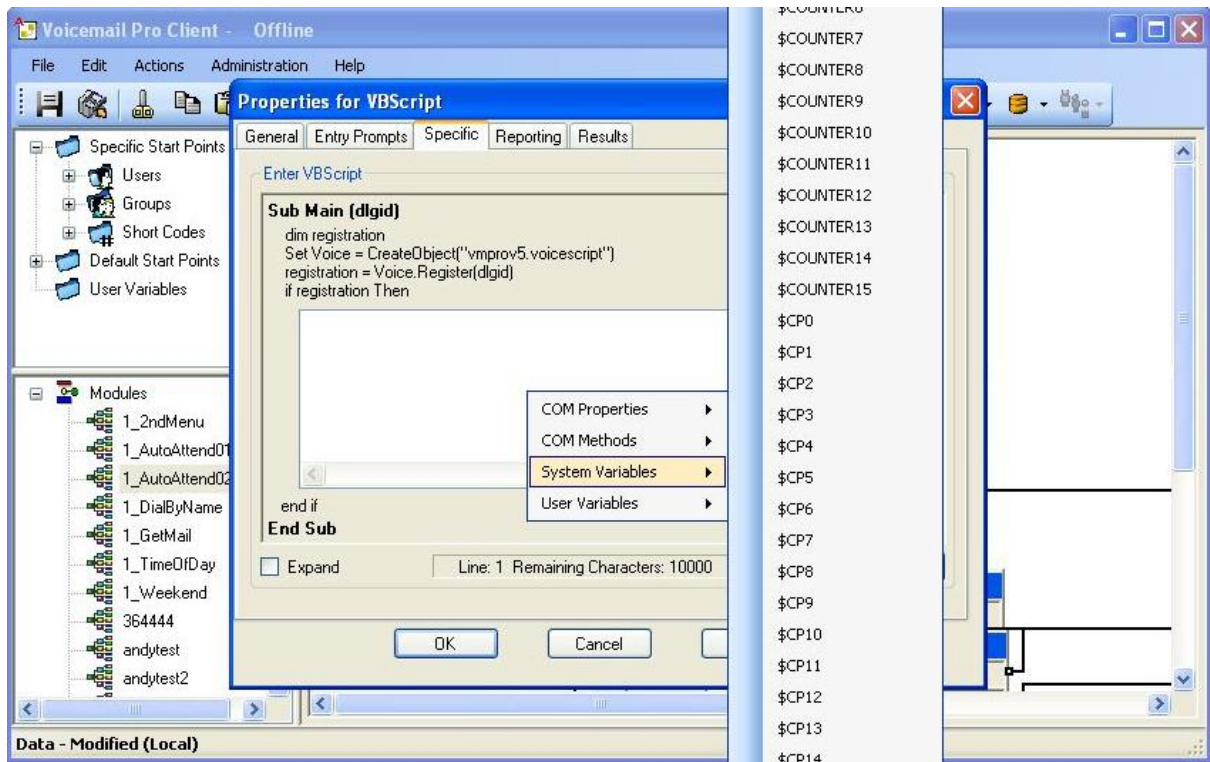

VB Scripting is enabled by the IP Office Advanced Edition license.



---

## Extended Personal Greetings

---

In INTUITY emulation mode, the Voicemail Pro system has the ability to hold a number of greetings within each user's mailbox that can be played to a caller. In addition to the standard mailbox greetings, the extended personal greetings provide the ability to present the caller with a greeting that reflects where the call has come from (internal or external) or why the called party is unable to take the call. A mailbox user can configure the responses played back to the caller, based upon the reason the caller was routed to the voicemail. The supported call states are:

- **Busy/Engaged**  
The user is currently on a call and unable to accept a second call.
- **No Reply**  
The user is away from the desk and unable to take a call.
- **Internal**  
A greeting to be played to internal calls
- **External**  
The greeting to be played to external callers
- **Out Of Hours**  
The greeting played when a hunt group is operating 'out of hours'. Out of hours is defined with IP Office Manager and is only applicable to hunt group mailboxes.

A greeting can be recorded for each of the above conditions through the Telephone User Interface (TUI). If a recording is made for each condition, the order of play back to a caller will be:

1. Out of hours (Hunt group mailboxes only).
2. Internal/External greeting.
3. Busy/Engaged.
4. No reply.

A mailbox owner will need to record greetings against these conditions to deliver the greeting that they wish to present to a caller. Avaya one-X™ Portal for IP Office users can record and manage their voicemail greetings through the Avaya one-X™ Portal for IP Office user interface.

---

## Hunt Group Broadcast Messages

---

With Voicemail Pro, two modes of operation exist for the handling of hunt group messages. The method used is configured for the group through the IP Office Manager.

- **Hunt group mode**  
Messages are stored in the hunt group mailbox and Message Waiting only informs those individuals configured for message waiting indication from that group. This is ideal for scenarios where only a few people such as a call center supervisor need to be initially aware of group messages. Any message waiting light lit by this is extinguished when the new hunt group message is accessed by a user. This is the default mode of operation.
- **Broadcast mode**  
Messages are not stored in the hunt group mailbox. Instead they are broadcast (copied and forwarded) to the individual mailboxes of the entire hunt group membership. This lights the individual messages waiting light of each user of the hunt group until they access their mailbox.

---

## Personal Distribution Lists

---

Personal Distribution Lists are only available with Voicemail Pro when operating in INTUITY emulation mode. The feature provides the ability for a user to distribute a voicemail message to a list of recipients simultaneously. Lists can be configured by a voicemail box subscriber either through their voicemail box telephone user interface (TUI) or through the desktop PC application Phone Manager Pro.

The features available to a voicemail box subscriber include:

- Create up to 20 lists with 360 members per list.
- Mark a list as private or public, Private lists cannot be accessed by any other voicemail subscriber. Public lists can be used by other subscribers but cannot be edited.
- Public lists can be copied from one subscriber to another by adding the contents into a new list.
- Subscribers can 'Create' new lists, 'Scan' contents of an existing list or 'Modify' existing lists.
- List members can be added by using the station number or mailbox name (names are not supported for Voicemail Pro Networked Messaging mailboxes).
- Lists can include voicemail boxes that exist on other Avaya voicemail systems that are available through Voicemail Pro Networked Messaging.
- Lists can be added together, duplicate members are automatically removed. This includes public lists owned by other voicemail subscribers.
- Mailing lists are accessible to the user at any 'send message' and 'forward message' option within the user's voicemail box.
- When displayed within Phone Manager Pro, distribution lists can have a list description added to it, this is only visible within Phone Manager Pro.

---

## Cascaded Out-Calling

---

Voicemail Pro can send a notification, with an escalation capability, that a new voice message has been received in a user's mailbox to specified phone number(s). This is particularly useful in environments such as healthcare and support where important voice messages are left and need to be answered promptly - even outside of office hours.

For example should a patient leave an important message to the main number of the doctor's office, the voicemail system can ring the doctor at the office then on no response escalates to the doctor's mobile/cell phone, his/her home phone or the doctor on duty after a programmable timeout. This avoids having to rely on an external answering service and allows mobile/cell and home phone numbers to remain private.

The voicemail notification can be sent for:

- Any new voice messages
- Any new priority voice messages

Mailbox owners can configure their own options from their handset (Telephone User Interface or TUI) and through their IP Office Phone Manager.

- Create own Time Profile – defining when notification should take place (e.g. office hours only)
- Out-calling destinations – defining where notification should take place and in which priority order

Five destinations can be defined by the mailbox owner through the TUI (Telephone User Interface). The destinations selected in the escalation list are called in sequence. The possible destinations are:

- Desk
- Mobile/Cell
- Home
- Delegate
- Other

Each time an outcall event occurs, each number in the escalation list will be called until either the call is answered, or the end of the list is reached. This process will be repeated on each retry attempt, for the number of retries set.

Out-calling preferences are set for global operation via the Voicemail Pro Client. Out-calling is only available in INTUITY Mode. The administrator sets the number of retries and time interval between retries on a system-wide level.

# Campaign Manager

As part of the IP Office Preferred Edition and Voicemail Pro, Campaign Manager enables the gathering of repetitive information from inbound calls (such as brochure requests) to be fully automated, leaving agents free to deal with other more complex calls which require human interaction. A definable sequence of recordings are played to the caller with time in between each recording to allow the capture of the caller's spoken answers and/or the caller's key presses via DTMF. At the end of the transaction the caller can be thanked and the completed transaction retrieved by an agent via a web interface or a short code.

Campaign Manager allows calls in queue to break out of the queue, or be directed in an overflow situation to complete their transactions thereby increasing customer satisfaction by affecting an answer to their call. This ensures that a minimum of customers give up when forced to wait in a queue or even worse, hear a recorded message stating that they are calling outside of office hours.

In a Contact Center environment, when agents are busy, an overflow to Campaign Manager relieves congestion and pressure on agent groups. An agent can collect the completed transaction via a web browser or via a short code representing the park slot number of a particular campaign. This number can be pre-programmed under a DSS key and used by agents to access the campaign. If the DSS key incorporates a BLF lamp, that lamp is lit when new campaign messages have been left. Agents then transcribe the caller's answers into a database or other records.

## Support for Internet Explorer 9 and Firefox 5

The Preferred Edition thin client WebCampaign is supported on the latest versions of the following browsers:

- Internet Explorer 9
- Firefox 5

The minimum level of support offered for browsers with the above clients are:

- Internet Explorer 8
- Firefox 3 (WebVoicemail only)
- Opera 10 (WebVoicemail only)

Customers using older browsers should upgrade to a more recent version but Preferred Edition will not prevent usage on the older browsers.

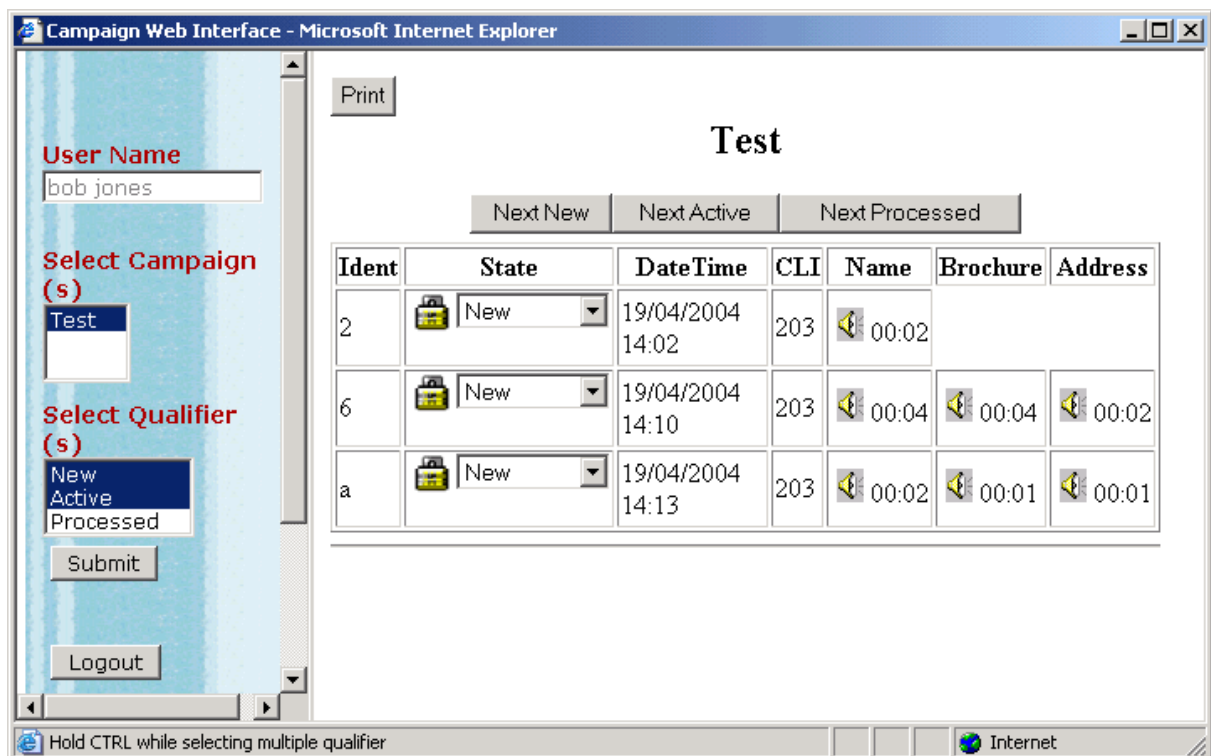

Campaign Web Interface

---

# Call Recording

---

IP Office Preferred Edition and Voicemail Pro also offer call recording services that allow the automatic/manual recording of calls for a variety of applications, such as for training purposes or to monitor abusive callers. As standard, recordings can be directed to the called extension's voicemail box or to any other mailbox for later retrieval. Alternatively, recordings can be stored in a central database for retrieval through a Web based browser by using ContactStore for IP Office.

An option allows to detect a tampered recording to avoid any abuse of recordings. This is available for recordings in a voicemail box and in the central database of contact store as well.

The system administrator can select whether all calls are required to be automatically recorded or just a selection of calls. Alternatively, calls can be manually selected for recording. If for any reasons resources are not available then a recording may not be taken (for example all voicemail ports are busy).

Voicemail Pro provides a number of methods for triggering the recording of a call.

Most of the settings and controls for automatic voice recording are accessed through the IP Office Manager application. The proportion of incoming and/or outgoing calls that should be recorded and the time-period during which Voice Recording should operate can be selected.

- **User Recording**  
The calls to and/or from a particular user can be automatically recorded. By default the recordings are placed in the user's mailbox. The configuration could be set whether on "external" calls only (default) or on "external and internal" calls.
- **Hunt Group Recording**  
The calls to a particular hunt group can be automatically recorded. By default the recordings are placed in the hunt group's mailbox, but there is the ability to select a target mailbox made for or on behalf of a subscriber. The configuration could be set whether on "external" calls only (default) or on "external and internal" calls.
- **Account Code Recording**  
An account code can be applied to a call by the user before it is made. This can be used to trigger recording of outgoing calls.
- **Caller ID Recording**  
Account codes can be assigned to a call by Caller ID matching. This allows recording to be based on a Caller ID match.
- **Time Profiles**  
For each user, hunt group and/or account code, an IP Office time profile can be used to determine when auto-recording is used.
- **Incoming Call Routes**  
Incoming Call Routes can trigger automatic call recording.

**Note:** It is possible for several recordings to be made of the same call. For example, if both automatic hunt group recording and automatic user recording are applicable to the same call, separate recordings are produced for both the hunt group and the user. Recording only continues while the party triggering the recording is part of the call, for example:

- Recording triggered by a user stops when that call is transferred to another user.
- Recording triggered by a hunt group continues if the call is transferred to another member of the same group.
- Recordings triggered by an incoming call route last until the call is cleared from the system.

Call recording uses the conference facility and so is subject to the conference restrictions of the IP Office system. For some situations, it may be a requirement that call parties are advised that their call is about to be recorded. This is done by switching on the Play Advice on Call Recording option via the Voicemail Pro client. The maximum length of any call recording is 60 minutes.

## Pause Call-recording

This feature allows you to pause call recording for a specific time period. This is typically useful when a client is communicating his/her credit card number with a Customer Service agent.

Leading credit card companies defined standards in the PCI Security Standard Council and one of these standards is not recording credit card numbers given by the customer. This feature allows us to comply with such standards.

The IP Officer user can pause call-recording manually via a toggle pause button that can be configured by an administrator through the Button Programming tab of the user configuration. The Pause Recording feature is available with both Centralized and Distributed Preferred Edition.

---

## Call Screening

---

When an incoming call arrives at your phone and is then directed to and answered by the voice mail system, you automatically hear the caller on your phone speaker, the caller cannot hear you. You can decide whether to answer the call or drop from the call and let the voice mail system continue to handle the call.

Call Screening is supported on the following:

- IP500, IP500 V2, and IP Office on Linux platforms
- Basic, Essential and Preferred Editions (centralized and distributed)
- Multi-site networks
- Internal calls targeting a user
- DID calls targeting a user
  - T1, PRI, E1, BRI, SIP
- Transferred calls targeting a user
- Applies to some types of forwarded calls targeting a user
  - Forward On No Answer
  - Forward On Busy
- Outside calls in Basic Mode where call is directed to voice mailbox of a line owner
- Mobile twinning to MyBuddy smartphone application
- Caveats:
  - Does not apply to Hunt Group calls
  - Does not apply to Operator or Calling Group
  - Does not apply to page calls
  - Will apply to master in internal twinning and/or to the sending deskphone as part of a mobile twinning relationship.

---

## IP Office ContactStore

---

The standard call recording facilities provided with IP Office and Voicemail Pro can be extended further by using IP Office ContactStore. IP Office ContactStore stores and catalogs recordings so that they are easily accessible for later retrieval. Any recordings that you instruct Voicemail Pro to "send to the Voice Recording Library" are placed in a database.

IP Office ContactStore is provided with the Voicemail Pro software DVD set and has an inbuilt 45 day trial license. A fully featured IP Office ContactStore system can be installed and used for 45 days from the creation of the first recording. After this time the system will stop taking recordings until a license is purchased and installed onto the IP Office.

IP Office ContactStore has a number of components, these are:

- An MSDE database into which details of all recorded calls are inserted.
- A browser-based call search and replay application.
- A browser-based system configuration and status monitoring application.
- Disk space management - Oldest recordings are automatically deleted as needed.
- Optional archive management - Recordings are automatically written to a DVD +RW drive.

To allow you to search for calls easily, the details of the recordings are stored within a MSDE database. It contains one record for each call recorded and additional records for each party on the call and the owner of the call. The information that is held for any recording is:

- A unique reference for the recording
- The start date and time
- The duration of the recording
- The name and number of the parties on the call- where this was available to IP Office (through ANI, Caller ID or DNIS) at the time of the call.
- The direction of the call (incoming, outgoing, or internal)
- The owner of the call recording
- The target or dialed number, which may be different from the number that actually took the call.

Recordings within IP Office ContactStore are stored as .WAV files. IP Office ContactStore uses the G.726 16kbps ADPCM compression standard, which provides the best compromise between storage capacity and CPU loading. IP Office ContactStore is designed to perform compression as a background task, which does not impact the system's ability to record, search or play other calls. It takes approximately 1 minute to compress a two hour recording. The compressed recordings are stored as 16kbps G.726 format, storage requirements are therefore 8MBs per hour of recording.

The IP Office ContactStore suite can be installed onto the same server as Voicemail Pro but must be loaded onto a separate partition. Alternatively, IP Office ContactStore can be installed on a separate drive within the same server or on a separate server. The minimum PC specification when Voicemail Pro and IP Office ContactStore are installed on the same server is detailed in the Voicemail System requirements later in this chapter.

IP Office ContactStore stores recorded calls with certain security in place. Access to recordings is strictly controlled according to the security constraints configured within the System Administration pages. Each recording has an owner; the call owner is the number of the extension that recorded the call. You can specify to which extensions each user has replay rights; the user can search for and replay all calls "owned" by those stations. Typically an individual may be given rights to replay calls owned by their extension number while managers may have rights to the extension numbers of all of their staff.

The system will automatically generate alarms showing system warnings. Alarms are logged to IP Office ContactStore's database and held for a month before being purged. The administrator can define specific Email addresses for alarms to be automatically forwarded to. The email recipient could be a local system administrator, a manned help-desk and/or suppliers' support desks if you have a support agreement that includes this facility. The system sends an email message each time an alarm occurs or is cleared. It also sends an email once per day as a "heartbeat" to let you know it is still operating. Failure to receive the daily heartbeat message should be investigated; it could indicate that the server has failed.

IP Office ContactStore allows replay of recordings by means of a browser-based application that is accessible with Internet Explorer (IE) V7.0 and higher. The Search and Replay facilities include the following features:

- Personal security restrictions. The restrictions are applied as you log into the web server.
- Criteria-based search filter fields to perform specific searches.

- Replay controls. Use the replay controls to start, stop, pause, skip forward, skip backward, or to export the recording to a readily playable .wav file.
- Audio waveform display. The waveform presents a graphic representation of the audio content of the call. Use the waveform to avoid replaying static or silences, and to move easily to specific portions of a call.

The Search and Replay screen, shown below, provides filter fields that you can use to search for calls:

**AVAYA ContactStore**  
powered by Verint Systems

02:14:30

Help | About  
Change Password  
Logout

**Administration**  
[Administer System](#)

**Search Filters**

Call Start Range

01/04/09 00:00:00  
13/05/09 23:59:59

Parties

Length

Target Number

Call Set

SEARCH

**Results**

Select All Select None

Call Start	Len	Parties	Type	Target
24/04/09 02:13:54	00:15	2205 (Extn2205), 2207 (Extn2207)	Outgoing	2207
24/04/09 02:14:26	00:12	3103 (Extn3103), 2205 (Extn2205)	Incoming	2205
24/04/09 02:24:27	00:09	2205 (Extn2205), 2207 (Extn2207)	Outgoing	2207
24/04/09 02:25:19	00:12	3103 (Extn3103), 2205 (Extn2205)	Incoming	2205
28/04/09 00:37:53	00:05	2205 (Extn2205), 2207 (Extn2207)	Outgoing	2207

For a single IP Office, ContactStore is enabled by the Advanced Edition license. Note: For ContactStore to work for remote nodes across a Multi Site Network there needs to be an Advanced Edition license present on each node. This is in addition to the Voice Networking license required for Multi Site Network.



---

## Centralized Messaging with Avaya Communication Manager

---

Where IP Office is deployed in an Avaya Communication Manager (ACM) Environment, it may be desirable to use one centrally managed voicemail system (Modular Messaging) to provide voicemail services to IP Office users. IP Office can be configured to use a Modular Messaging system over a remote connection such that all messaging calls divert to this location and message waiting indications are provided from the remote location and are displayed correctly on IP Office extensions. Connectivity must be either an E1 or T1 circuit or an IP trunk running QSIG services. In addition to the IP Office license Key (Centralized VM with ACM RFA) that enables this service, further license keys may be required on the ACM system.

# Voicemail Feature Comparison

## Platform Support

	IP Office Preferred Edition Voicemail Pro	IP Office Essential Edition Embedded Voicemail
IP500 V2	Yes	Yes
IP500	Yes	Yes

## Capacities

Voicemail	IP Office Preferred Edition Voicemail Pro	IP Office Essential Edition Embedded Voicemail
Number of Mailboxes supported	No Limit - Limited only by IP Office configuration.	Limited only by IP Office configuration.
Maximum Number of Concurrent Calls (ports)	Up to 40 dependent on license	6 simultaneous calls on IP500 V2. 4 simultaneous calls on IP500.
Recording Time	PC dependent (Requires 1MB per minute)	IP500 V2: 2 ports: Up to 15 hours 4 ports: Up to 20 hours 6 ports: Up to 25 hours  IP500: Up to 15 hours

## Features

	IP Office Preferred Edition Voicemail Pro	IP Office Essential Edition Embedded Voicemail
Runs as a service	Yes	No
Multi-lingual support	Yes	Yes
Voicemail for Individual users	Yes	Yes
Voicemail for Virtual users	Yes	Yes
Voicemail for Hunt Groups	Yes	Yes
Group Broadcast	Yes	No
Unified Messaging Service (UMS)	Option	No
Integration with Microsoft Exchange Server	Option	No
Capable to interact with Blackberry solution	Option <sup>[1]</sup>	No
Resilience and Backup	Option	No
Small Community Network Operation	Yes	No
Centralized Voicemail Services	Yes	No
Distributed Voicemail Servers in an SCN	Yes	No
Voicemail Ringback	Internal and external	Yes
Voicemail Help TUI	Yes	No
Message Waiting Indication	Yes	Yes
Visual Voice (interactive menu on phone display)	Yes	Yes
Integration with Phone Manager Pro	Yes	No
Personalized Greeting	Yes	Yes
Extended personal Greetings	Yes <sup>[2]</sup>	No
Continuous Loop Greeting	Yes	No
Forward to Email	Yes	Yes
Copy to Email	Yes	Yes
Listen To Email (Text To Speech)	Yes <sup>[2]</sup>	No
Send Email notification	Yes	Yes
Unified Messaging Service (UMS)	Option	No
Save Message	Yes	Yes
Delete Message	Yes	Yes
Forward Message to another Mailbox	Yes	Yes

<b>Forward to Multiple Mailboxes</b>	Yes	Yes
<b>Forward with a Header Message</b>	Yes	Yes
<b>Repeat Message</b>	Yes	Yes
<b>Rewind Message</b>	Yes	Yes
<b>Fast Forward Message</b>	Yes	Yes
<b>Pause Message</b>	Yes	No
<b>Skip Message</b>	Yes	Yes
<b>Oldest message first/newest message first Message Playback Option</b>	Yes	No
<b>Set Message Priority</b>	Yes <sup>[2]</sup>	No
<b>Set automatic message deletion timeframe</b>	Yes	No
<b>Alphanumeric Data Collection</b>	Yes <sup>[2]</sup>	No
<b>Callers Caller ID, time and date announced</b>	Yes	Yes
<b>Call Back Sender (if Caller ID available)</b>	Yes	Yes
<b>Remote Access to Mailbox</b>	Yes	Yes
<b>User Definable PIN Code</b>	Yes	Yes
<b>Known Caller ID PIN Code By-Pass</b>	Yes	Yes
<b>Breakout to Reception</b>	Internal and external.	Internal and external.

1. Requires UMS (enabled through the Power User, Office Worker and the Teleworker licenses) and MS Exchange Server 2007/2010 with a mobility solution (for example a Blackberry) - not provided by Avaya.
2. Intuity mode only.

### In-Queue Announcements

	<b>IP Office Preferred Edition Voicemail Pro</b>	<b>IP Office Essential Edition Embedded Voicemail</b>
<b>Queue Entry Announcement</b>	Yes	Yes
<b>Queue Update Announcement</b>	Yes	Yes
<b>Queue Position Announcement</b>	Yes	No
<b>Time in Queue Announcement</b>	Yes	No
<b>Time in System Announcement</b>	Yes	No
<b>Estimated Time to Answer (ETA)</b>	Yes	No
<b>Exit Queue to alternative answer point</b>	Yes	No

### Auto-Attendant/Audiotex

	<b>IP Office Preferred Edition Voicemail Pro</b>	<b>IP Office Essential Edition Embedded Voicemail</b>
<b>Multi-Level Tree Structure</b>	Yes	Yes
<b>Message Announcements</b>	Yes	No
<b>Whisper Announce</b>	Yes	No
<b>Alarm Calls</b>	Yes	No
<b>Assisted Transfers</b>	Yes	No
<b>Dial by Name</b>	Yes	Yes
<b>Direct Dial by Number</b>	Yes	Yes

### Other Features

	<b>IP Office Preferred Edition Voicemail Pro</b>	<b>IP Office Essential Edition Embedded Voicemail</b>

<b>Call Recording</b>	Yes	No
<b>Tamper proofed / verified Call Recording</b>	Yes	No
<b>Test Conditions</b>	Yes	No
<b>Personal Numbering</b>	Yes	No
<b>Speaking Clock</b>	Yes	No
<b>Campaign Manager</b>	Yes	No
<b>Voicemail Pro Manager</b>	Yes	No
<b>Customized Voicemail</b>	Yes	No
<b>Intuity TUI emulation mode.</b>	Yes	No
<b>Forward Emails to External Systems (VPIM)</b>	Yes	Yes
<b>Third Party Database Access (IVR)</b>	Yes	No
<b>Text To Speech within call flows</b>	Yes	No
<b>Support for Visual Basic Scripts</b>	Yes	No

# Chapter 16.

# Mobility

# 16. Mobility

Sales or service reps who are always on the road know the challenges: missed calls, phone tag, languishing voice messages, delays in decision making and frustrated customers. Plus the real possibility of missed transactions and lost revenue. Equipped with Avaya IP Office Mobility Solutions, mobile associates never need to miss an important customer call or a question from someone in the office. And they'll be able to give customers just a single phone number — their office number — where they can be reached regardless of their location. Personal mobile phone numbers are never given out, but all calls ring simultaneously on their desk telephones and their mobile telephones. So if they are at their desks or on their mobile telephones, they'll get the call. With IP Office Mobility Solutions they maintain the agility that gives them an edge over larger competitors. Decision-making will be speeded-up, quick responses to customers and colleagues are enabled, and the solutions will help to ensure that deals close with this real-time connection.

One-X Mobile applications require answer supervision and disconnect detection for proper functioning. As a result, the one-X Mobile applications will not work with trunks that do not support answer supervision and disconnect detection. One-X Mobile applications will function properly on trunk types such as PRI, BRI, and SIP. However, they will not function properly on E1R2, T1 RBS and analog loop start trunks as these trunks do not support answer supervision and disconnect detection.

## one-X Mobile Preferred for IP Office

The one-X ® Mobile Preferred for IP Office is a mobile application available for iOS and Android smartphones. The one-X ® Mobile Preferred for IP Office application provides rich unified communications capabilities for the mobile workforce and is designed to give mobile users quick access to various forms of communications and help users conduct normal business while on the move. The application relies on permanent data connection with the communications server and is designed to provide an "always-on" experience delivering asynchronous events of interest to the user as they arrive from the communications server.

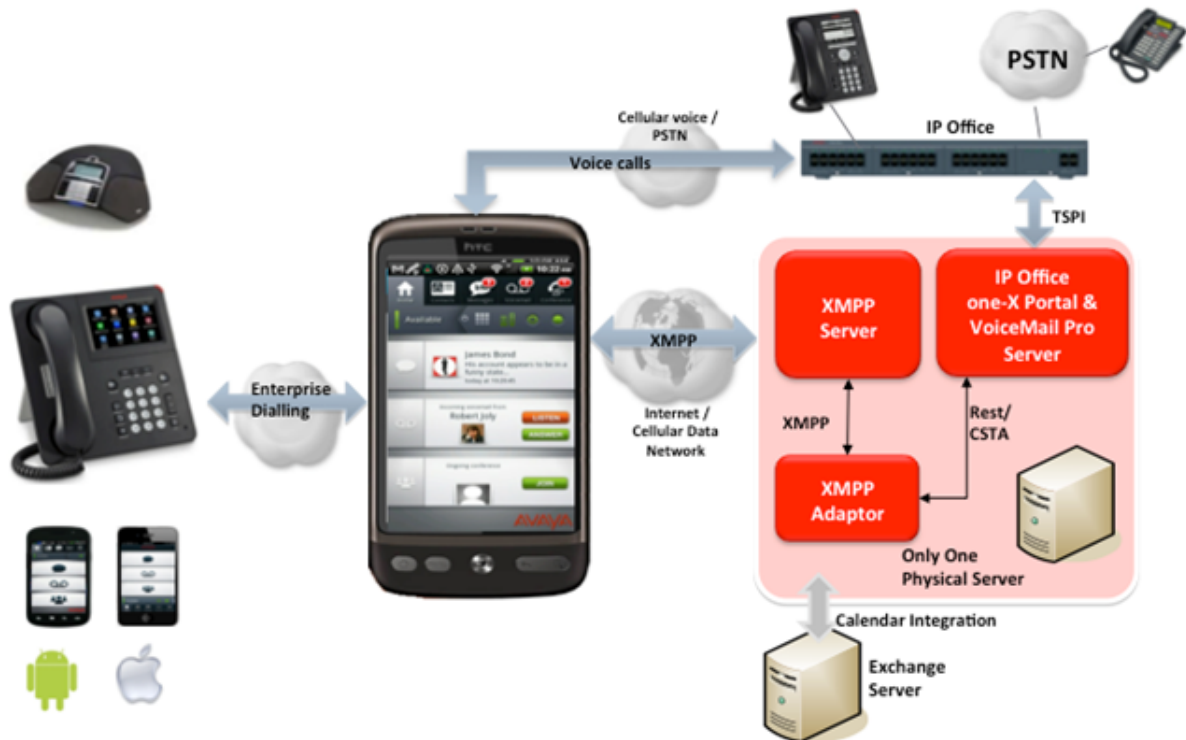

The application utilizes a rich user interface available on the mobile platform and makes use of advanced capabilities and hardware commonly available on mobile devices including streaming audio for visual voicemail, speech recognition to issue audible commands and geo-location presence using on-board GPS.

The application provides unified communications capabilities with the following features set:

- Presence and Instant Messaging with server-side buddy lists and server-managed user groups and client side IM history
- Visual voicemail with ability to play voicemail messages and ability to manage voicemail messages from the mobile application
- Rich conference controls with click-to-conference for users and groups, entry and exit notifications, ability to view and manage conference participants (mute/unmute/disconnect/isolate)
- Advanced user presence monitoring and reporting including geo-location presence and tracking, calendar and on-the-phone presence, following user's presence and availability
- Asynchronous voicemail deposit events with ability to listen and intercept voicemail deposits
- Ability to issue commands to the communications server including call, conference, set location, and view missed calls, and listen/pickup
- Enterprise dialling, which is an ability to intercept calls made via standard phone dialer and turn them into enterprise calls (third-party call control by the server)
- Ability to define dial plan rules to select which calls to intercept and ability to post-process the dialed numbers to normalize them to the enterprise dialling plan to make the intercept seamless
- Android home screen widget with summary of outstanding events asynchronously notifies mobile users about events of interest such as – outstanding IM messages, new deposited VM messages, conference participants entry/exits, VM deposits in progress



### Avaya one-X Mobile Preferred Client Support

The following table lists the various mobile devices and operating systems supported by the one-X Mobile Preferred client and the download site on the respective App Stores:

<b>one-X Mobile Preferred</b>			
<b>Mobile device</b>	<b>Supported OS</b>	<b>Posted Application Name</b>	<b>Download site</b>
iPhone	iOS 5	one-X Mobile Preferred	<a href="#">Apple App Store</a>
Android	Android OS 2.1 and above	one-X Mobile Preferred	<a href="#">Google Play Store</a>



---

## On-Site Mobility

---

IP Office offers different solutions for users working mainly at the business campus but with the need to be accessible all over the site.

### Avaya On-Site Wireless Phone Solutions

Avaya IP Office Wireless Solutions include DECT and WiFi based wireless IP telephones. These are solutions employees can use every day to work more effectively and be more responsive to customers - all while increasing revenues and keeping communication costs firmly under control. Also, Avaya IP Office Mobility Solutions integrate seamlessly with IP Office, enhancing each customer's investment. IP Office's in-building Mobility Solutions improve communication with staff who, because of the function they perform, are mobile within the workplace. Using wireless technology, such individuals may be instantly contactable, with many obvious benefits:

- The wireless telephone is carried in the pocket, so users are not tied to the desk in order to remain in contact.
- Users may be contacted instantly to ensure fast, accurate decision making and immediate response to problems through planned radio coverage with no blind spots.
- Once installed the solutions do not incur additional cost like mobile telephones would do, allowing a tight budget control.

### Wireless Solutions

IP Office supports the following wireless solutions:

- DECT R4, the DECT based solution for IP Office. Running in a separate, reserved frequency range, this solution provides best in class voice quality and is totally interference free from other radio equipment. Details on this solution portfolio can be found in the chapter "Telephones" of this document.
- Avaya VoIP WiFi Solution, leveraging the WiFi data network, allow a single infrastructure for both voice and data traffic. Leveraging an existing, voice ready WiFi network allows a cost efficient deployment of a converged wireless data and voice infrastructure using the 802.11a, b and g standard. The solution is offered worldwide in selected countries including North America, EU countries and selected others. For details on this solution please refer to the chapter "Telephones" of this document.

### Remote Solutions

IP Office supports the following VPN remote phone solutions:

- VPN phone client on 4610SW, 4621SW, 5610SW, 5621SW and 9600 Series IP telephones offered worldwide.

For further details about IP Office On-Site Mobility solutions please refer to the chapter [Telephones](#)<sup>[107]</sup> of this document.

## Twinning

Twinning allows a primary extension and a secondary number (internal extension or external number) to operate together as a single telephone, when a call is presented to the primary phone the secondary will ring. If the primary telephone does not ring, for example in Do Not Disturb, the secondary phone will not ring.

The following types of calls are eligible for twinning:

	Internal Twinning	Mobile (external) Twinning
<b>Any internal call on a Call Appearance button</b>	✓	✓
<b>Internal or external calls transferred to the extension</b>	✓	✓
<b>Direct Dial calls to that extension</b>	✓	✓
<b>Hunt group calls</b>	✓	✓
<b>Calls forwarded from another extension</b>	✓	✓
<b>Line Appearance calls (configurable)</b>	✓	✗
<b>Bridged Appearance calls (configurable)</b>	✓	✗
<b>Coverage calls (configurable)</b>	✓	✗
<b>Automatic Intercom calls</b>	✓	✗
<b>Returning transferred, held or park calls</b>	✓	✓*
<b>Callback calls from the system (Transfer and Park Return)</b>	✓	✗
<b>Paging calls</b>	✓	✗
<b>Follow Me calls</b>	✓	✗

\*Requires IP500 BRI, PRI or SIP trunks and Mobile Call Control to be enabled for that user.

## Internal Twinning

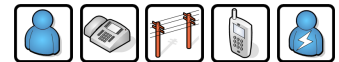

This is typically used in scenarios like workshops or warehouses where team supervisors may have a desk with a fixed phone but also have a wireless extension (e.g. DECT). Other users of the system need not know that the supervisor has two different telephones. The supervisor's Coverage Timer and No Answer Time are started for the call and if the call is not answered within that time, the call will be delivered to available coverage buttons (if applicable) and then Voicemail (if applicable).

The following features are supported with internal twinning:

- Follow Me To
- Follow Me Here
- Forwarding
- Do Not Disturb (inc exceptions)
- Context less hunt group actions: Membership / Service Status / Fallback Group configuration
- Voicemail On / Off / Access
- Call Log (Central Call Log for T3 and 1400/1600/9500/9600 telephones only)
- Redial (Central Call Log for T3 and 1400/1600/9500/9600 telephones only)
- Personal Directory Entries (for T3 and 1400/1600/9500/9600 telephones only)

# External Mobility

Mobility functions for employees are enabled only by the appropriate and applicable license. The Mobile Worker and Power User licenses enable the use of the one-X Mobile Preferred client. Essential Edition licenses enable the use of one-X Mobile Essential client (for up to four Remote Worker seats—customers that require more than four seats require an upgrade to Preferred Edition). The former Mobile Twinning/Mobility License will continue to work with all the features described below.

The mobility functions enabled by the user licenses defined above are **Mobile Twinning** and **Mobile Call Control**. Each feature has to be enabled in IP Office Manager for the eligible users.

## Mobile Twinning (External Twinning)



A typical use for Mobile Twinning would be for a salesperson that has a desk extension but is often out of the office. They only give out their office phone number to clients, but the IP Office Mobile Twinning will ring their mobile/cell phone as well as the desk extension. External mobile devices can be set as twinning targets even if the primary telephone is logged out (e.g. in the case of a "virtual" extension).

## Call Back



To avoid any call charges when using a mobile / cell phone the call back feature has been implemented:

When calling a particular number at the IP Office, the IP Office will reject the call and will call back the mobile number if this number has been identified as an eligible one. After accepting this call the mobile user gets a dial tone and can establish another call. Depending on the service provider's tariff, there are no call charges (except possible roaming charges) on the mobile invoice. However, in some countries like US there are charges to even receive the calls.

This feature is very useful for employees using their personal mobile phone for business only from time to time: their personal mobile phone number stays confidential and they do not to claim mobile charges back from their business.

## Avaya one-X Mobile Essential Client Support



IP Office supports the Avaya one-X Mobile Essential 'Single Mode' Clients for a variety of mobile devices, listed below. This client provides Avaya's powerful Extension to Cellular features to mobile users via a graphical interface and enables them to remain productive with a single phone number for both incoming and outgoing calls and single voicemail capabilities. The client turns your smartphone into an office phone by delivering your business calls to your mobile device. In addition, you can easily enable or disable the office phone capabilities, allowing you to be reached only when you want.

IP Office systems supporting one-X Mobile Essential require a dedicated DID/DDI number for each feature required (e.g. hold, transfer).

The following table lists the various mobile devices and operating systems supported by one-X Mobile Essential client and the download site on the respective App Stores:



one-X Mobile Essential			
Mobile device	Supported OS	Posted Application Name	Download site
iPhone	iOS 3.2 and above	Avaya one-X Mobile Lite	<a href="#">Apple App Store</a>
Android	Android OS 2.1 and above	Avaya one-X Mobile	<a href="#">Google Play Store</a>
Blackberry	Blackberry OS 5, 6 or 7	Avaya one-X Mobile	<a href="#">Blackberry App World</a>
Windows Mobile	Windows Mobile 5 or 6	Avaya one-X® Mobile for Windows Mobile – Telephony	<a href="#">Avaya Support</a>
Symbian	Symbian OS S60 3.2	Avaya one-X® Mobile for Symbian - Telephony	<a href="#">Avaya Support</a>

## Mobile Call Control



This allows a user who has answered a twinned call on their mobile/cell phone to dial a DTMF sequence \*\* (star-star) to put the call on hold and receive IP Office system dial tone. The user will then be able to perform supervised and un-supervised transfers, shuttle (switch between held calls), and conference (Conference add and transfer to a meet-me conference).

Mobile Call Control is a mobility feature similar to but independent of one-X Mobile Essential. It allows any mobile phone user to access IP Office features without using the one-X Mobile Essential client application.

Mobile users can gain access to the "Star Star Service" dial tone when they receive a twinned call. After receiving a twinned call, the mobile user can dial \*\* to place that call on hold and get dial tone from the IP Office. Once the mobile user receives IP Office dial tone, any subsequent dialing tone is interpreted as if the user is logged into an analog extension on the IP Office.

To gain access to the "Star Star Service" dial tone, the mobile user can dial the FNE 31 DID/DDI that has been programmed in the IP Office. Similarly, once dial tone is heard, the user can dial numbers and short codes as if the user is logged into an analog extension on the IP Office.

Mobile Call Control and one-X Mobile Essential require twinned calls to be routed through specific trunk types on IP500 / IP500 V2 only:

- IP500 PRI-U (single or dual) trunk cards
- IP500 Dual or Quad BRI trunk cards
- SIP trunks (RFC 2833)

## IP Office Video Softphone



Usable both inside the office and at remote locations, IP Office Video Softphone is a PC-based telephony client allowing a user to make and receive phone calls right from his PC, equipped with e.g. a headset or speakerphone. In addition, the softphone supports end-to-end video between two softphone users on an IP Office network. Full voice access to the IP Office system is available wherever reliable access to the company network exists.

This can be in meeting rooms, using a Voice ready WiFi network, at a remote office site using the local Ethernet interface or at home or in a hotel-room, when connecting to the company network through a VPN (Virtual Private Network).

The softphone offers standard calling functionality, like several call appearances, hold, transfer and access to a large number of IP Office features via dedicated feature keys. Access to IP Office directory is of course also available.

If used in combination with the Avaya one-X™ Portal for IP Office application, the softphone delivers a centralized call log, synchronized with many IP Office telephones as well as a number of collaboration features like presence status indication and instant messaging. one-X Portal can be used with the standard deskphone while working in the office and switched to softphone when working remote.

Details about IP Office Video Softphone can be found in the chapter [User Call Control Applications](#) <sup>304</sup>.

## Mobile Messaging



Mobile Messaging means managing your voice messages together with email messages using the mobile / cell phone. Similar to a unified messaging solution on the desktop PC it enables the user to manage all of their daily messages in one place, in this case the mobile messaging application of the mobile / cell phone (like for example Outlook Mobile on Windows Mobile devices).

At the low end of the range of mobile messaging options is the simple voicemail-to-email forwarding using SMTP, which is standard with both the Essential and Preferred Edition.

The synchronization of the voice message status between all a user's devices (Outlook, voicemail telephone interface, Avaya one-X™ Portal for IP Office, mobile / cell phone) so that listening to a new message at one device changes the message status from "new" to "old" in all of these interfaces requires the Preferred Edition. It contains an IMAP interface to integrate the Voicemail Pro solution with any IMAP capable email system.

With the IP Office Preferred Edition in conjunction with an Exchange 2007/2010 Server it is possible to synchronize received voice mails with the email system. If the email system also empowers mobile users to receive, manage, and send messages by their mobile phone ('Mobile Email') all voice mails can be managed as well from the mobile / cell phone.

Together with an appropriate mobility solution like Blackberry the Exchange 2007/2010 integration enables visual voicemail on mobile devices. The voice mails provided by the Preferred Edition are specially marked as "voicemail" so Exchange 2007 handles them different from standard emails so that a mobility solution will be able to show voice mails on the display of the mobile device. Users can now browse through the voicemails, identify high priority ones by caller information and listen to them first.

## 3rd Party Mobility Solutions for Use with IP Office



Although Avaya offers different mobility solutions as mentioned above, there are areas for further improvement. Together with Avaya DevConnect partners, Avaya is anxious to further extend the usability and functionality of the IP Office system.

The following mobility solutions in particular add mobile devices currently not supported by Avaya for the IP Office so that users with one of these devices can participate from the rich IP Office mobility options.

### Apple iPhone – iEC5xx



As the iPhone from Apple is increasingly used for business use, Avaya has enabled an available DevConnect solution to extend IP Office mobility also to this popular device. The application for the iPhone is called 'iEC5xx' and acts like the Avaya one-X Mobile Essential clients. The same configuration file that is been used to configure the Avaya clients enables the mobility functions at the iPhone.

The application is available at the Apple App Store.

For more information see <http://elinfierno.de/apps/iec5xx/>

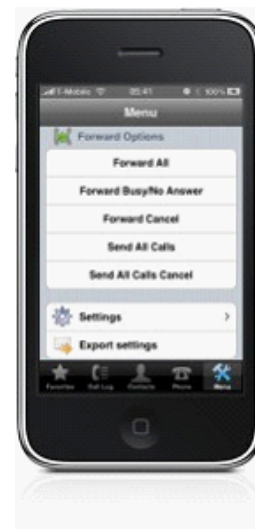

### Blackberry – SoLo DTMF Client



One of the most used mobile business devices is the RIM Blackberry. To use a Blackberry with similar functions like the Avaya one-X Mobile Essential application, the solution called "SoLo DTMF client" from SoSoftware enables selected Blackberry devices to use the IP Office mobility functions.

For more information and placing orders see <http://www.sossoftware.com/solo-mobile-dtmf>

These 3<sup>rd</sup> party solutions have the same requirements as the Avaya mobility options. Each user who wants to use one of the solutions requires at least one Power User or Mobile Worker license. A Preferred Edition license might also be required.



# Chapter 17.

# Audio Conferencing



# 17. Audio Conferencing

A problem familiar to any organization is that of communicating effectively. As more and more people work from home or from dispersed locations, how do you ensure that employees are planning and working together effectively, and regularly keeping in touch when separated by time and distance? In addition, many companies choose to sub-contract some services such as payroll, logistics or manufacturing to third-party suppliers. How do you ensure that you can act as one virtual enterprise? Audio conferencing provides a simple and effective solution.

Audio conferencing makes it easy to include key people in decision making wherever they are with minimum interruption from their work. It responds to business needs that every company faces:

- More meetings but less time available.
- Increasing pressure to be at two locations at once.
- Travel restrictions.
- Environmental pressures ("green" initiatives).

As a result of using conferencing, the benefits gained are:

- Reduction in travel, leading to lower costs, less wasted time and lower carbon emissions.
- Increased worker productivity and personal security.
- More effective working practices, leading to shorter project times, and supporting dispersed organizations and complex supply chains.

Furthermore, the Return On Investment (ROI) is very short as Meet Me conferencing is a built-in feature of IP Office Preferred Edition. The typical ROI of just 4 to 6 months compared to Service Provider conferencing services based upon 2 hourly conferences with 5 participants per week.

# IP Office Preferred Edition Meet-Me Conferencing Solution

The conferencing solution built-in to IP Office enables multiple callers to talk in an audio conference. Callers can be on-site personnel as well as external parties whether field-based engineers, sales staff on the road, customers or suppliers. Conference calls can be planned in advance or established ad-hoc as and when required.

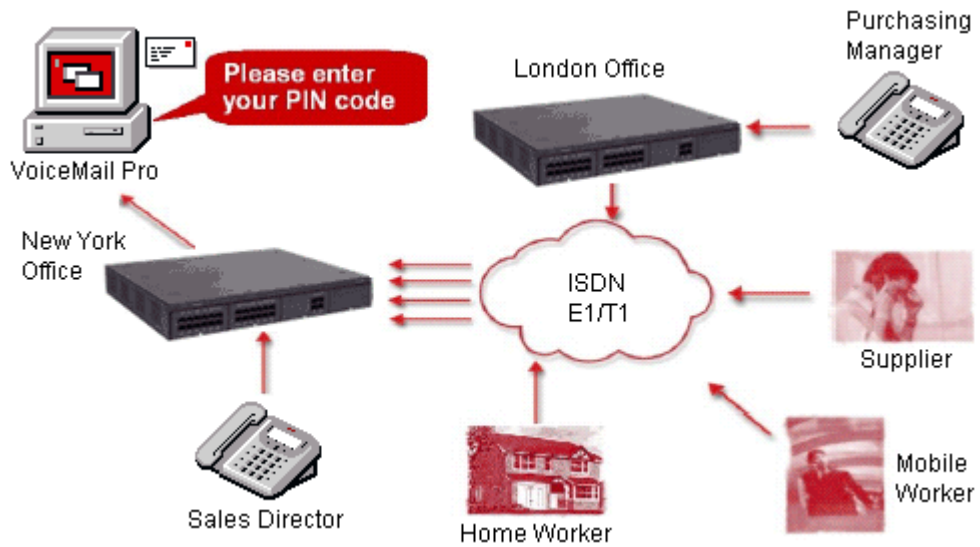

IP Office Preferred Edition with Voicemail Pro complements the built-in conference bridge facility on IP Office systems by allowing participants to enter conferences through dedicated numbers, adding guidance prompts as well as requesting PIN codes as participants enter the conference for security. For example, if conference calls are regularly scheduled, Voicemail Pro can have pre-programmed Call Flows for weekly conference calls e.g. every Tuesday between 2pm and 5pm using PIN code 1234 for a sales call, etc. If multiple conference calls are scheduled, users can select which one they want to attend via a simple menu. Should users encounter any issues, calls can be automatically routed to the operator for assistance. For additional security, if Caller ID information is provided by the network Voicemail Pro can make CallerID checks before allowing calls into a conference.

---

## IP Office Conferencing Capacity

---

IP Office provides a flexible conferencing solution with 128 conferencing channels on the IP500 and IP500 V2, allowing multiple conferences of any size from 3 to 64 parties. This means that several conferences of different sizes can all run at the same time if the total calls do not exceed the systems conference resources. So the system will support 42 x 3-party conferences, 2 x 64-party conferences or any combination in between. IP Office does not impose limits on the mix of internal and external calls in conference, but if all internal participants disconnect from the conference bridge, the external participants can be disconnected automatically by the system for added security (configurable system setting).

### Notes:

- 1. Analog Trunk Restriction**  
In conferences that include external analog line calls, a maximum of two analog line calls are allowed per conference.
- 2. External Participants**  
Each external caller requires a digital trunk/VoIP channel (for example 1 T1 allows 23/24 external parties, 1 E1 allows 30 parties and a fully licensed VCM-64 allows 64 parties).
- 3. Use of Conference Resources by Other Features**  
System features such as call intrusion, call recording and silent monitoring all use conference resources, as does automatic recording if enabled. When any of these features are active the number of slots available for conference parties is reduced. For example, a conference call between 3 parties and being recorded will use 4 conference slots.
- 4. The IP500 Supports 128 Conference Members**  
The total capacity of the IP500 V2 is 128 party conference resources. However the restriction of a maximum of 64 parties in any individual conference still applies.
- 5. Meet-Me Conferencing on IP500 requires Preferred Edition**  
IP Office IP500 V2 supports basic or ad-hoc conferencing, but if Meet-Me capabilities are required the IP Office Preferred Edition license should be purchased for direct dial into a conference bridge with PIN code security.  
In an SCN network, only one centralized Preferred Edition license is required to host Meet-Me conferences at any of the sites. Also, with the release of IP Office Release 8.0, conference IDs are shared across the SCN sites.

---

## IP Office Standard Conferencing Features

---

The IP Office provides the following features and benefits relating to conferencing:

- **No special conferencing equipment required**  
You only need an IP Office system unit with as many digital trunks/VoIP channels as external participants (as well as Preferred Edition for Meet-Me conferences).
- **Ease of use**  
Simply dial the direct number allocated to the conference bridge, type in the PIN if required and you have joined the conference (PIN codes require Preferred Edition/Voicemail Pro).
- **Conference control from Avaya Display telephones\* and Avaya one-X™ Portal for IP Office**  
For ad-hoc conferences with a few participants, users can easily set up immediate conferences by calling all parties and bringing them to the conference bridge. With Avaya one-X™ Portal for IP Office , the originator of the conference can keep control: the Caller ID number (and the associated name if recognized) of each participant is displayed. If required, they can selectively hang-up a specific participant.
- **Customized greeting**  
Record a personalized greeting per conference (requires Preferred Edition/Voicemail Pro).
- **Conference entry/exit tones**  
Single beep on entry/double beep on exit
- **Conference call recording**  
Manual recording initiated by user on IP Office via Avaya one-X™ Portal for IP Office , Phone Manager, digital/IP display phone or a short code (requires Preferred Edition/Voicemail Pro)
- **Security**  
To prevent unauthorized access to the conference bridge, PIN codes, Caller ID number screening as well as time and date profiles can be set-up using IP Office Voicemail Pro.
- **Privacy**  
In cases where the security of calls is critical, in-house conferencing is the only way to ensure privacy.
- **Remote Management**  
Allows a single person to manage the conferencing bridge facility from any location. Furthermore, the full IP Office solution—phone system, voicemail, CTI server, router, firewall and DHCP server—can all be managed from a single management interface called IP Office Manager.
- **Multi-site Small Community Network (SCN) Conferencing**  
IP Office enables users joining a conference that is on another IP Office within the network (ConfMeetMe) to have the call automatically routed to that IP Office and join the conference. No special configuration is required.
- **Personal Conference**  
The owner of the conference may use their extension number as the conference ID. The owner of the conference has control of the conference with the ability to mute and drop calls of participants. All participants will hear the system Music on Hold (MOH) till the owner joins, and will hear MOH when the owner drops.

\*Feature supported on 1408/1608/2410/5410/4610/5610 and 1416/1616/2420/5420/5621/4621/4625 as well as 9500 and 9600 Series IP telephones. Note that any internal party has the option to view & drop participants (not just the conference originator).

# Chapter 18.

# The Contact Center

# 18. The Contact Center

Avaya provides Customer Contact solutions that meet the needs of the small to mid-size business. From the smallest company that requires basic system performance reporting to the larger businesses that need advanced routing and multimedia integration with the Customer Contact Center. Avaya provides IP Office Customer Call Reporter as the perfect solution to meet the needs of small business customers.

---

## Customer Call Reporter

---

### Overview

Contact Centers are a requirement at nearly every level of business, from very small informal groups of 5 or 10 "customer service reps", to large formal campaigns that can involve thousands of agents.

However, customers in the small business market are generally very nervous about making such a high profile investment in a "contact center solution." They require a "business intelligence solution" that deploys easily, can be managed with very little training, and can provide statistics on each segment of the business. Small businesses also do not have the resources for extra IT staff to administer databases, servers, etc, so they need a solution that can be easily understood by their own employees. It should operate as a service to each of the clients.

### IP Office Customer Call Reporter Concept

IP Office Customer Call Reporter is a server based contact center product designed explicitly for small businesses. Drawing upon the latest web and design technologies, IP Office Customer Call Reporter introduces significant new capabilities to effectively and efficiently manage a single-site call center environment. The product focus is on ease of use and deployment simplicity to ensure improved ongoing productivity and lower support costs.

In its native web server environment the IP Office Customer Call Reporter can be simply installed onto a single server without the need for any client software deployment. Administration and management of the call center is carried out via a thin client through a secure password protected web browser session.

IP Office Customer Call Reporter Key Features include:

- Real time Call Center activity monitor and historical reporting
- Microsoft server based with thin client (web browser) client connections
- Simplified installation and maintenance
- Supervisor Dashboard which consists of a goal, statistics information ticker and a set of graph display panels
- Seven reporting templates provide drag and drop and user defined filter functionality
- Three customizable Supervisor views and summarized Agent views
- Report Scheduler
- Custom Reports
- Customer Map
- Multi-lingual capable
- Supports up to 30 Supervisors and 150 Agents

### IP Office Customer Call Reporter Business Benefits

- **Lower TCO**  
IP Office Customer Call Reporter provides small businesses with a web based contact center measurement tool, producing cradle to grave reporting in an easily understandable format with no client software to load.
- **Standards Based**  
IP Office Customer Call Reporter uses standards based applications, such as Microsoft SQL 2008 Express, and supports all major web browser software, to provide small business installers with greater flexibility in deployment.
- **Ease of Use**  
IP Office Customer Call Reporter's real-time charts can be customized by the user in the manner that suits their business best, with historical reporting templates that allow the business to filter on the type of date they want to see.

### Ordering IP Office Customer Call Reporter

Customer Call Reporter supports the following maximum configurations for IP Office:

- 150 Agents
- 30 Supervisors

Activation of IP Office Customer Call Reporter is provided with the purchase of the IP Office Advanced Edition, the Advanced Edition is a specialized call center bundle which also enables the following:

- Contact Store for IP Office (CSIPO)
- Voicemail Pro database interaction (IVR)
- Voicemail Pro Visual Basic Scripting
- 1 Customer Call Center Supervisor

Additional agents and supervisors can be purchased on top of the Advanced Edition.

The IP Office has a setting in IP Office Manager for designating which hunt groups will be reported upon by IP Office Customer Call Reporter. Any hunt group that contains an agent who is not properly licensed will not be able to retrieve any reporting on that group (real-time or historical).

### **IP Office Customer Call Reporter Server Operating System Requirements**

The IP Office Customer Call Reporter services are supported on the following operating systems (only 32-bit versions are supported unless stated otherwise):

- Microsoft Windows Server 2003 SP2
- Microsoft Windows Server 2003 R2
- Microsoft Windows Small Business Server 2003 R2
- Microsoft Windows Server 2008 SP2 (32-bit and 64-bit)
- Microsoft Windows 7 (Professional, Enterprise, and Ultimate; 32-bit and 64-bit)

### **IP Office Customer Call Reporter Server Hardware Requirements**

The minimum server specifications are as follows:

- IP Office Customer Call Reporter server  
Intel Pentium D 945 core/AMD Athlon 64 4000+; with 2GB RAM and 30 GB free hard disk space

**Note:** The IP Office Customer Call Reporter server can co-reside with a Voicemail Pro of less than 17 ports.

### **IP Office Customer Call Reporter Client Components**

The client application consists of a secure thin client web browser session to the IP Office Customer Call Reporter server that will provide the Supervisor or Agent with a complete view of the Call Center.

The following web browsers will be supported:

- Microsoft Internet Explorer 8 and later
- Mozilla Firefox 3.0 and later
- Google Chrome 10 and later

### **IP Office Customer Call Reporter Database**

The database has been designed to provide a simple table schema. The database is a Microsoft SQL Server 2008 instance and the IP Office Customer Call Reporter will be packaged with the Microsoft SQL Server 2008 Express edition. It is recommended that any call center that predicts high call usage should understand the imposed limitations of Microsoft SQL 2008 Express edition and should consider using the full version of Microsoft SQL 2008. Microsoft SQL 2000 and 2005 are not supported.

The CCR Database is documented and open for third parties to create their own custom reports in Crystal Reports or any other SQL related application.

# Dashboard

This is the default page shown when a supervisor logs in. It shows information graphs for selected queues, agents and statistics.

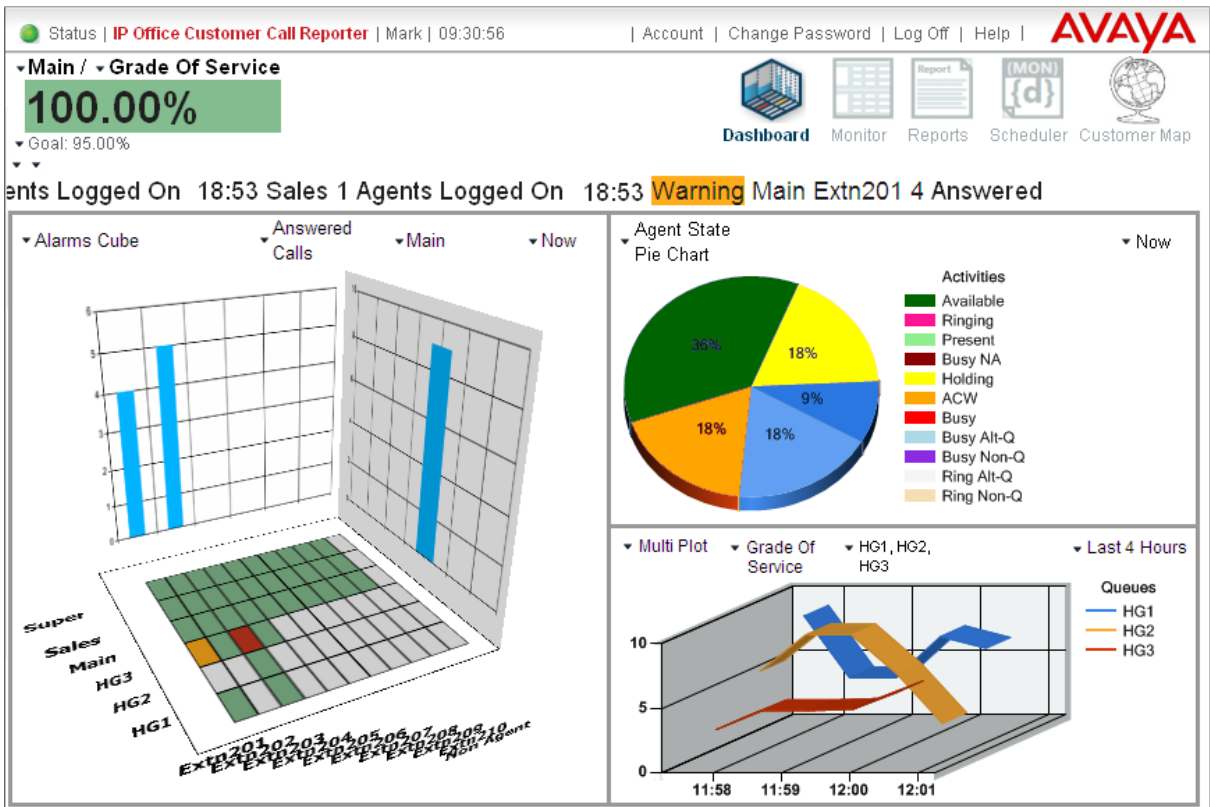



## Real Time Report/Monitor

Customer Call Reporter provides real time monitoring of call center activity. This is achieved via a thin client web browser session logged onto the IP Office Customer Call Reporter server. Within the supervisor client a user can program up to 3 different views of their call center. This is a very useful feature as now a supervisor can divide their responsibilities into different views and compare the results of those views.

For example, assume that a call center supervisor is responsible for the following hunt groups in IP Office; Computer Sales (201), Monitor Sales (202), Warranty Service (203), and non-Warranty service. The Supervisor can create two separate views entitled "sales" and "service" and compare the number of calls, length of call, etc. This allows a supervisor to see a whole system as it relates to the business function (sales, service).

The Supervisor views are private and can only be seen with a login. A view may be created that shows the system with all the agents, specific Hunt Group and Agent statistics as well as Alarms and Warnings. Each of the three views are summarized and made available to any Agents when they login and select their corresponding Supervisor. An example of the Supervisor real-time view is shown below:

The screenshot displays the AVAYA IP Office Customer Call Reporter interface. At the top, there is a navigation bar with the following elements: Status, IP Office Customer Call Reporter, Mark, 17:02:47, Account, Change Password, Log Off, Help, and the AVAYA logo. Below the navigation bar, there are icons for Dashboard, Monitor, Reports, Scheduler, and Customer Map. The main content area shows three views: View 1, View 2, and View 3. The 'View 1' view contains two tables. The first table shows queue statistics for HG1, HG2, and a TOTAL row. The second table shows agent statistics for Agent1 through Agent8 and Extn872. An 'Alarm Ticker' at the bottom displays the message '09:33 Alarm HG1 8 Calls Waiting'.

Queues	Agents Ringing	Answered Int Queue	Answered Calls	Average Ans %	Queue State T	Calls Waiting
HG1	1	1	3	6.10	00:00:09	8
HG2	2	2	3	6.39	00:00:03	1
TOTAL	3	3	6			9

Agents	Average Ans Time	Average Ans %	Agents Call Share
Agent1	6.41	1.18	8.51
Agent2	2.24	2.63	7.90
Agent3	8.61	4.94	1.66
Agent4	7.51	2.80	5.29
Agent5	8.98	5.43	6.79
Agent6	2.12	8.34	4.71
Agent7	4.65	1.79	8.54
Agent8	2.70	8.52	0.56
Extn872	4.13	6.39	4.52

**Alarm Ticker All Views**  
09:33 Alarm HG1 8 Calls Waiting

## Alarms

The Customer Call Reporter provides different levels of alarms for the supervisor and agent to properly manage their call center activity. As parameters move from a normal to alarm state, the color of the field within the realtime view will change depending upon the level of alarm; white for normal, yellow for caution, red for alarm, and blue for alarm acknowledged. The following statistics can have alarms set against them within the IP Office Customer Call Reporter:

Statistic Full Name	Available for ...				Warning/ Alarm Type
	System	Queue	Agent	Total	
Agent Productivity	✓	✓	✓	✓	>1-99%
Agent State (Queue)	-	-	✓	-	-
Agent State (Queue) Time	-	-	✓	-	>1-999
Agent State (System)	-	-	✓	-	-
Agent State (System) Time	-	-	✓	-	-
Agents ACW	✓	✓	-	✓	>1-150
Agents Available	✓	✓	-	✓	<1-150
Agents Call Share	-	-	✓	-	-
Agents Logged On	✓	✓	-	✓	<1-150
Agents Present	✓	✓	-	✓	-
Agents Ringing	✓	✓	-	✓	-
Answered Calls	✓	✓	✓	✓	>1-999
Answered External (Non-Queue)	-	-	✓	-	>1-999
Answered Internal (Non-Queue)	-	-	✓	-	>1-999
Answered Internal (Queue)	✓	✓	✓	✓	>1-999
Average Answer %	✓	✓	✓	✓	<1-100%
Average Answer Time	✓	✓	✓	✓	>1-600
Average Wait Time	✓	✓	-	✓	>1-600
Busy Not Available	✓	✓	-	✓	>1-150
Calls Waiting	✓	✓	-	✓	>1-999
Current Wait Time	✓	✓	-	✓	>1-600
Grade of Service	✓	✓	-	✓	<1-100%
Internal Made	-	-	✓	-	>1-999
Longest Wait Time	✓	✓	-	✓	>1-600
Lost Calls	✓	✓	✓	✓	>1-999
New Messages	✓	✓	-	✓	>1-999
No Answer	✓	✓	✓	✓	>1-999
Outbound Calls (External)	-	-	✓	-	>1-999
Overflowed Answered	✓	✓	-	✓	>1- 999
Overflowed Calls	✓	✓	-	✓	>1-999
Overflowed Calls Waiting	✓	✓	-	✓	>1-999
Overflowed Lost	✓	✓	-	✓	>1-999
Presented Calls	✓	✓	✓	✓	>1-999
Queue State	-	✓	-	-	-
Queue State Time	-	✓	-	-	>1-600 <sup>[2]</sup>
Routed to Other	✓	✓	✓	✓	>1-999
Routed to Voicemail	✓	✓	✓	✓	>1-999
Talk Average	-	✓	✓	✓	>1-600
Talk Inbound	✓	✓	✓	✓	-
Talk Inbound Average	✓	✓	✓	✓	-
Talk Internal	✓	✓	✓	✓	-
Talk Outbound	✓	✓	✓	✓	-
Talk Outbound Average	✓	✓	✓	✓	>1-600
Talk Total	✓	✓	✓	✓	-
Transferred	✓	✓	✓	✓	>1-999

## Agent View

In Customer Call Reporter, the Agent view is part of the agent reporting license, every licensed agent will be able to run their own view. An Agent is able to login via a thin client web browser session and associate with a Supervisor. The Agent view also displays any alarms that have been set by the Supervisor.

Status | IP Office Customer Call Reporter | Agent3 | 17:02:47 | Change Password | Log Off | Help | AVAYA

Graph

View 1 | View 2 | View 3

Queues	Agents Ringing	Answered Int Queue	Answered Calls	Average Ans %	Queue State T	Calls Waiting
HG1	1	1	3	6.10	00:00:09	8
HG2	2	2	3	6.39	00:00:03	1
<b>TOTAL</b>	<b>3</b>	<b>3</b>	<b>6</b>			<b>9</b>

Agents	Average Ans Time	Average Ans %	Agents Call Share
Agent3	8.61	4.94	1.66

---

## Historical Reporting

The IP Office Customer Call Reporter reporting package has been simplified to enable the user to easily retrieve the reporting information they need from one of seven standard drag and drop report templates. The IP Office Customer Call Reporter offers "cradle to grave" reporting for businesses that want to track specifically how a call was routed through their business. The historical reporting is accessed via the Supervisor login.

### IP Office Customer Call Reporter Report Templates

The following main report templates are available with IP Office Customer Call Reporter:

- **Agent Summary Report**  
This report type details the call activity for agents in a queue or for specific agents.
- **Call Details Report**  
The Call Details Report contains details of the total number of calls, internal calls (optional), external outbound calls and the total number of external inbound calls.
- **Call Summary Report**  
The Call Summary Report contains details of the total calls presented and answered; the average speed to answer in percentage and average speed to answer time, the number of calls overflowed and lost, the average abandon time as well as the grade of service.
- **Trace Reports**  
The Trace Report lists in chronological order all the events, date and time stamped that involved the user selected.
- **Alarm Reports**  
Alarm reports can be created for the Supervisor Views. All the alarms for the selected subject are listed over a user specified time period. Totals are included that show the number of warning and critical alarms received for each unique alarm type included in the report.
- **Voicemail Reports**  
The report shows the following information; Total calls answered by the Auto-Attendant (Voicemail Pro), total calls abandoned (lost) in Auto-Attendant, and a table of unique call flow trigger names with a tally of the number of times the trigger has been received (e.g. who pressed 1 for sales in the Auto-Attendant).
- **Agent Time Card Report**  
This report summarizes agent performance including time logged in, talk time, time in various states, calls made and answered and agent performance. The report does not include internal calls.

### Creating an IP Office Customer Call Reporter Report

From the seven basic report templates within IP Office Customer Call Reporter, a user can create over 100 different reports depending upon how they want to see the information that is most useful for their business. All standard report templates have common fields that can be completed to create a report. And when entering details in a field a wildcard '\*' can be used to represent everything. The common fields are listed below:

- **Report Name**  
The text entered is used as the main title of the report. If the report is saved this is the saved name of the report.
- **Subject**  
This is the main subject of the report. The drop down list offers a list of report subjects that are pertinent to the report i.e. Hunt Group, Agent, DDI etc.
- **Filter**  
The filter is used to refine the data and again offers filters that are pertinent to the report i.e. All, Answered, Lost, etc.
- **Exclude Internal**  
When selected, internal calls are excluded from the report.
- **Working Hours**  
The start and finish time of the working day can be specified using the spin controls.
- **Group Results by**  
The drop down list offers a list of display options.
- **Scheduled**  
By default this field is shown as 'Manual'. If the option 'Scheduled' is selected then additional fields are available:
- **Report Format**  
The format that the report is to be produced in can be selected from Adobe, Word, Excel, Rich Text or Crystal.
- **Email Address**  
An email address can be entered if the report is to be sent by email.

- **Printer**  
The printer path that the report should be sent to.
- **Report Period**  
Selection of days, weeks or months from a list box. The number of days or weeks is counted from the date that the report is first scheduled to be run. Months are from the last full months data i.e. if the report is scheduled in February then January will be the last month in the report.
- **Report Range**  
The start and end date for the report.
- **Language**  
If the default language is not required then another language can be selected that your system supports.

Filters can be used in the report to provide exactly the type of information the customer is looking for. The filter field is used to refine the data and offers the following options in a drop down list; All, Answered, Refused, Refused Overflowed, Overflowed All, Overflowed Off PBX, Overflowed on PBX, Transferred and Lost Calls. The default setting is all.

Reports can also be scheduled for future delivery to any network printer or email address in any of the supported formats.

## IP Office Customer Call Reporter Report Examples

### Call Details Report:

### Call Details Report

03/20/2012 - 03/20/2012 00:00 - 23:59

Report Type		Target Name				Supervisor Name			
Call Details Report - All		Queue				Supervisor 1			
*									
Time Stamp	Call Direction	Number	DDI	Queue	Queue Time	Agent	Duration	Status	Reference
Ungrouped									
03/20/2012 12:53:00	Inbound	6133@148.147.206.169	6200@192.168.177.240	HG8601	00:00:11	Extn8602	00:00:08	New Call	000033
03/20/2012 12:53:00	Inbound	6133@148.147.206.169	6200@192.168.177.240	HG8602		Extn8604		Transferred	000033
03/20/2012 12:53:00	Inbound	6133@148.147.206.169	6200@192.168.177.240	HG8601		Extn8602	00:00:08	Connected	000033
<b>Summary</b>									
Customer Calls		5	Internal Calls		1	External Inbound Calls		4	
						Initiated Outbound Calls		0	

### Call Summary Report:

### Call Summary Report

03/20/2012 - 03/20/2012 00:00 - 23:59

Report Type		Target Name							Supervisor Name			
Call Summary Report		Queue							Supervisor 1			
*												
Ungrouped	Customer Calls	Answered Calls	Lost Calls	Overflowed Answered	Overflowed Lost	Routed To VoiceMail	No Answer (Timeout)	Avg. Answer Time (%)	Avg. Answer Time	Avg. Abandon Time	Grade Of Service (%)	
HG8601	4	4	0	0	0	0	1	100.00	10.0	-	100.00	
HG8602	3	3	0	0	0	0	0	100.00	8.3	-	100.00	
Customer Calls		5		Routed To VoiceMail		0		Grade of Service		100.00		
Answered Calls		7		No Answer (Timeout)		1		Answer Threshold		600		
Lost Calls		0		Average Answer Time (%)		100.00		Lost Call Threshold		1		
Overflowed Answered		0		Average Answer Time		9.3		Initiated Outbound Calls		0		
Overflowed Lost		0		Average Abandon Time		-						

## Agent Time Card Report:

# Agent Time Card Report

03/20/2012 - 03/20/2012 00:00 - 23:59

Report Type	Target Name	Supervisor Name
Agent Time Card	Agent	Supervisor 1

03/20/2012

Extn8601

Shift	00:00:00	Lunch	00:00:00	Breaks	00:00:00
-------	----------	-------	----------	--------	----------

Calls:	Answered	1	Connected Outbound	0	No Answer	0
--------	----------	---	--------------------	---	-----------	---

Talk Time:	Inbound	00:00:05	Outbound	00:00:00	Total	00:00:05
	Av In	00:00:05	Av Out	00:00:00	Av Total	00:00:05

Performance:	APF	100.00%	Av Ans Time	9.0
--------------	-----	---------	-------------	-----

Group Summary:

Calls:	Answered	1	Connected Outbound	0	No Answer	0
--------	----------	---	--------------------	---	-----------	---

Talk Time:	Inbound	00:00:05	Outbound	00:00:00	Total	00:00:05
	Av In	00:00:05	Av Out	00:00:00	Av Total	00:00:05

# Supervisor Wallboard

For the release of IP Office R6, Customer Call Reporter now provides a browser based wallboard that can be used in businesses who want to display key statistics in a group area, such as on an LCD television screen.

The wallboard has the ability to display all the statistics currently available within Customer Call Reporter, but can also provide two additional new features:

- A scrolling message board, for important messages during the course of the working day
- A standings or "leader" board, which displays the top agents for a particular activity during the day

In addition to this, the wallboard can also be customized with the company's logo and colors. Also, there is no limit to the number of statistics that can be displayed (caution: adding too many statistics may cause the displayed statistics to be too small to be viewed reasonably).

## Wallboard Requirements

- The wallboard can run on all the supported browsers for Customer Call Reporter.
- Microsoft Silverlight is a required plug in that can be downloaded before starting the wallboard.

## Wallboard Licensing

The Customer Call Reporter wallboard is based upon the number of supervisors licensed within CCR, for each supervisor license purchased; there can be one instance of the wallboard. If five supervisor licenses are active on the system, then five instances of the wallboard can be used throughout the business. The wallboard logins do not have to be unique, for example, the system may have only one wallboard account set up within CCR, but that same account can be used for as many supervisor licenses that exist on the system.

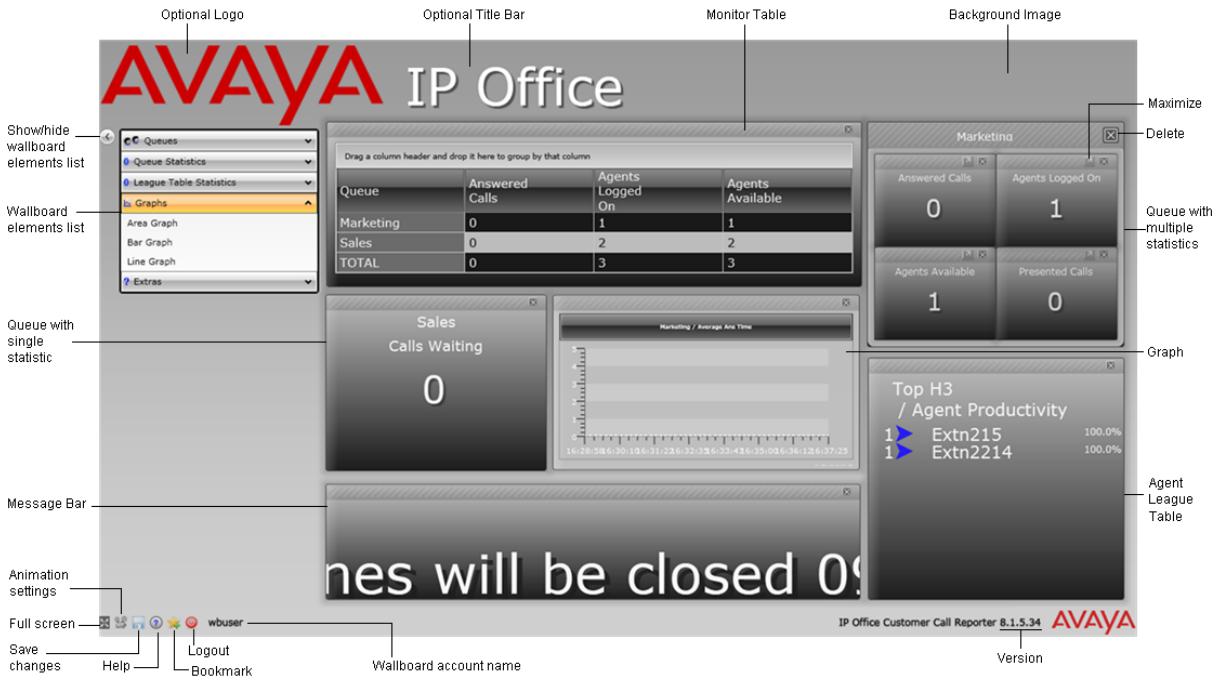

## Call Statistics

The Customer Call Reporter provides detailed statistics to help small businesses understand exactly where a call has been within the business. Statistics are measured against (also refer to the table below):

- **Queues**  
Points in the call center where a queue forms such as hunt groups.
- **Agents**  
Individuals that are members of queue groups who answer the calls.

Statistic Full Name	Available for ...				Call Type <sup>[1]</sup>		Warning / Alarm Type	Include Overflow	
	System	Queue	Agent	Total	Ext'	Int'		From	To
Agent Productivity	✓	✓	✓	✓	✓	✗	>1-99%	✓	✗
Agent State (Queue)	-	-	✓	-	-	-	-	-	-
Agent State (Queue) Time	-	-	✓	-	-	-	>1-999 <sup>[2]</sup>	-	-
Agent State (System)	-	-	✓	-	-	-	-	-	-
Agent State (System) Time	-	-	✓	-	-	-	-	-	-
Agents ACW	✓	✓	-	✓	-	-	>1-150	-	-
Agents Available	✓	✓	-	✓	-	-	<1-150	-	-
Agents Call Share	-	-	✓	-	-	-	-	-	✓
Agents Logged On	✓	✓	-	✓	-	-	<1-150	-	-
Agents Present	✓	✓	-	✓	-	-	-	-	-
Agents Ringing	✓	✓	-	✓	✓	✓	-	-	✗
Answered Calls	✓	✓	✓	✓	✓	✓	>1-999	✗	✗/✓ <sup>[3]</sup>
Answered External (Non-Queue)	-	-	✓	-	✓	-	>1-999	-	-
Answered Internal (Non-Queue)	-	-	✓	-	-	✓	>1-999	-	-
Answered Internal (Queue)	✓	✓	✓	✓	-	✓	>1-999	✗	✗
Average Answer %	✓	✓	✓	✓	✓	✓	<1-100%	✓	✗
Average Answer Time	✓	✓	✓	✓	✓	✓	>1-600	✓	✗
Average Wait Time	✓	✓	-	✓	✓	✓	>1-600	✓	✗
Busy Not Available	✓	✓	-	✓	-	-	>1-150	-	-
Calls Waiting	✓	✓	-	✓	✓	✓	>1-999	✗	✓
Current Wait Time	✓	✓	-	✓	✓	✓	>1-600	✓	✓
Grade of Service	✓	✓	-	✓	✓	✓	<1-100%	✓	✗
Internal Made	-	-	✓	-	-	✓	>1-999	-	-
Longest Wait Time	✓	✓	-	✓	✓	✓	>1-600	✓	✗
Lost Calls	✓	✓	✓	✓	✓	✓	>1-999	✗	✗/✓ <sup>[3]</sup>
New Messages	✓	✓	-	✓	-	-	>1-999	-	-
No Answer	✓	✓	✓	✓	✓	✓	>1-999	✗	✗/✓ <sup>[3]</sup>
Outbound Calls (External)	-	-	✓	-	✓	-	>1-999	-	-
Overflowed Answered	✓	✓	-	✓	✓	✓	>1- 999	✓	✗
Overflowed Calls	✓	✓	-	✓	✓	✓	>1-999	✓	✗
Overflowed Calls Waiting	✓	✓	-	✓	✓	✓	>1-999	✓	✗
Overflowed Lost	✓	✓	-	✓	✓	✓	>1-999	✓	✗
Presented Calls	✓	✓	✓	✓	✓	✓	>1-999	✓	✗/✓ <sup>[3]</sup>
Queue State	-	✓	-	-	-	-	-	-	-
Queue State Time	-	✓	-	-	-	-	>1-600 <sup>[2]</sup>	-	-
Routed to Other	✓	✓	✓	✓	✓	✓	>1-999	✓	✗
Routed to Voicemail	✓	✓	✓	✓	✓	✓	>1-999	✓	✗
Talk Average	-	✓	✓	✓	✓	✗	>1-600	✗	✗/✓ <sup>[3]</sup>
Talk Inbound	✓	✓	✓	✓	✓	✗	-	✗	✗/✓ <sup>[3]</sup>
Talk Inbound Average	✓	✓	✓	✓	✓	✗	-	✗	✗/✓ <sup>[3]</sup>
Talk Internal	✓	✓	✓	✓	✗	✓	-	✓	✗
Talk Outbound	✓	✓	✓	✓	✓	✗	-	✓	-
Talk Outbound Average	✓	✓	✓	✓	✓	✗	>1-600	✓	-
Talk Total	✓	✓	✓	✓	✓	✗	-	✓	✗/✓ <sup>[3]</sup>
Transferred	✓	✓	✓	✓	✓	✓	>1-999	✓	✗

1. With statistics that support both internal and or external calls, the selection of which call types are reported is selectable through the statistic's settings.
2. For **Agent State (Queue) Time** and **Queue State Time**, separate time thresholds can be set for each state that has been selected to alarm.



3. ✓/✗\* For **Answered Calls, Lost Calls, No Answer, Talk Inbound, Talk Inbound Average, Talk Total, Talk Average,** and **Presented Calls** queue calls that overflowed to a queue are included in agent statistics but not in queue statistics.
4. This documentation uses the full name for IP Office Customer Call Reporter statistics and states. However, for the display in browser screens, the IP Office Customer Call Reporter can use abbreviated names. The statistics however remain the same.

# Custom Reports

## Contact Center Reporting Custom Reports

IP Office Release 8.0 introduces the ability to create custom reports using Microsoft Report Builder and then to upload the custom report file to Advanced Edition. The custom report capability in Release 8.0 is targeted at the technically savvy supervisor or a customer service organization that can create reports to meet a customer's requirement.

## Microsoft Report Builder & Custom Report files

IP Office Release 8.0 supports Report Builder 2.0 or 3.0 from Microsoft. It can be installed from SQL 2008 Express with Advanced Services (part of the pre-requisite folder). It can also be installed manually.

Report Builder can be launched from within Customer Call Reporter if installed with SQL 2008 Express with Advanced Services. Report Builder is used to create and test Custom Reports before they are uploaded into Customer Call Reporter.

Report Builder can be launched from within Customer Call Reporter and it can be bookmarked. A base Custom Report file and a suite of sample Custom Report files can be downloaded from Advanced Edition to simplify the custom report file creation. Once a custom report file has been created, the file is uploaded into Customer Call Reporter. Once these files are in Customer Call Reporter, it can be used in the same way as the existing reports. Custom report files can be deleted or downloaded, used for Report generation and used to create report templates.

Custom Report generation is integrated within Advanced Edition Historical Report management tools to allow Template copy, Recent Reports, Scheduled Report, Email, Print and Export (PDF, Word, Excel, and TIFF).

IP Office Release 8.0 also delivers of many sample Custom Reports including some that are mimic the standard historical reports. These can be used as a convenient starting point if the custom report is similar to an existing report. The list of sample reports is being finalized at this point and will be added to a later version of this document.

## Sample Custom Report Capabilities

The following is a system-level report with sample gauges and text box cells for statistics, call rate and parameters.

System		1/1/2011 - 10/24/2011 09:00 - 17:00							
Custom Report Name		Supervisor Name							
System		Supervisor2							
<b>Sample Report - System</b>									
Call Rate Per Hour: 0.0									
Total Hours: 1688.0									
Last Switch Disconnection: 10/21/2011 3:02:03 PM									
									
Customer Calls	Presented Calls	Total Calls	Answered Calls	Lost Calls	Overflow Answered Calls	Overflow Lost Calls	Routed To Voicemail Calls	Refused Calls	
28	29	42	15	4	5	2	3	13	
After Call Work Time	Busy Not Available Time	Inbound Talk Time	Internal Talk Time	Non Queue Time	Off Hook Time	Outbound Talk Time	Queue Enabled Time	Ringling Time	Hold Time
00:15:43	00:00:32	01:39:52	02:30:03	00:01:40	00:21:32	00:05:48	119d:09:13:56	00:03:37	00:00:21

## Customer Map

The customer map shows the location of callers based on the caller's number. When a caller's location has been identified, a pin is placed on the map at that location. The color of the pin changes with the volume of calls that match that same location. When the caller cannot be resolved beyond just a country, a colored button is used instead of a pin. Hovering your cursor over a pin or button displays details of the location and the number of callers from that location.

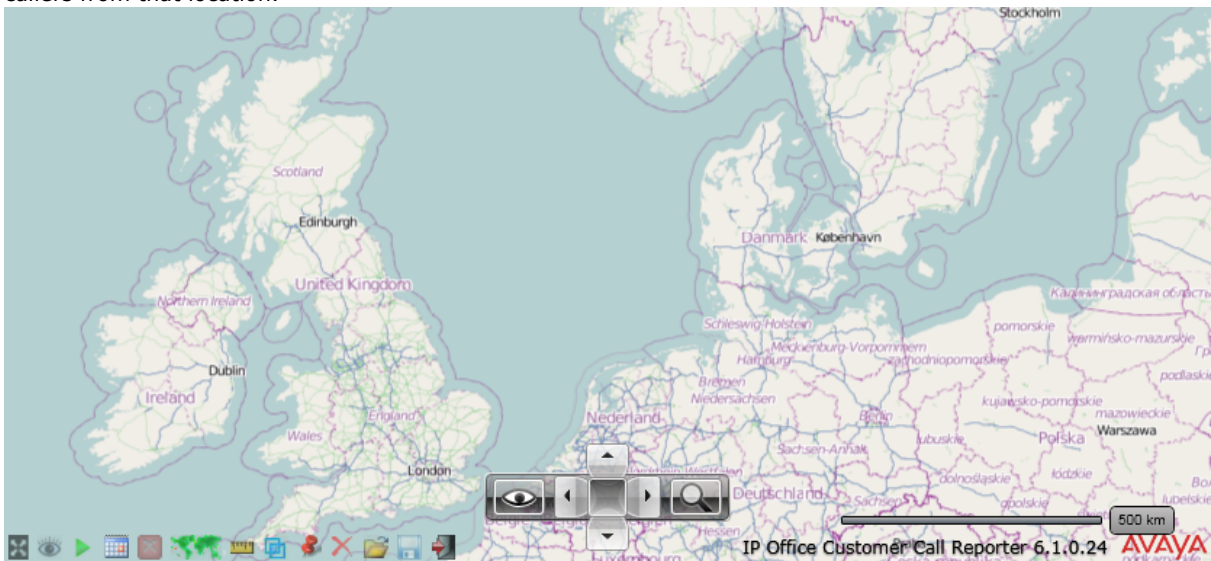

The customer map can use a number of different map backgrounds. These vary by map provider and map type.

Map Type	Map Provider		
	Open Street Maps	Yahoo Maps	Outline Map
Road View			
Aerial View			

# Chapter 19.

# Management Utilities

# 19. Management Utilities

This section gives an overview of the management applications that are common to all IP Office platforms.

- [IP Office Web Manager](#)<sup>[414]</sup>  
IP Office's main configuration tool.
- [IP Office Simplified Manager](#)<sup>[426]</sup>  
A flavor of the IP Office Manager targeted for Sub-20 type deployments. [IP Office Monitor](#)<sup>[422]</sup>  
A trace utility for trouble shooting.
- [SNMP](#)<sup>[423]</sup>  
Alerts and alarms from IP Office systems to SNMP tools or to SMTP email.
- [System Status Application \(SSA\)](#)<sup>[424]</sup>  
A diagnostic tool to monitor and check the status of IP Office systems.
- [Data Migration Manager \(DMM\)](#)<sup>[425]</sup>  
A migration tool to facilitate configuration data from BCM and Norstar® products to IP Office.

# IP Office Web Manager

IP Office Web Manager is a new browser-based management tool designed to simplify the installation and maintenance process by providing an intuitive and user-friendly management tool that runs on most standard browsers. The new IP Office Web Manager eliminates the need to have windows operating system as it can run on any device that supports standard browsers.

## IP Office Web Manager supports the following modes of IP Office:

- Quick Mode A-Law
- Quick Mode Mu-Law
- PARTNER Mode
- Norstar Mode (PBX, KTS)

## Browser Support

Following browsers will be supported:

- Microsoft Internet Explorer 8 and later
- Mozilla Firefox 3.0 and later
- Windows 4.0 and later
- Google Chrome 10 and later
- Apple Safari 3.1 and later

## Login Page

The super user logs on to the system using the system default username and password.

Default User name: "Administrator"

Default Password: "Administrator"



## Menu Driven Configuration

The IP Office Web Manager has a newly designed menu that enhances the navigation. The tool is designed to configure tasks or features via parameters.

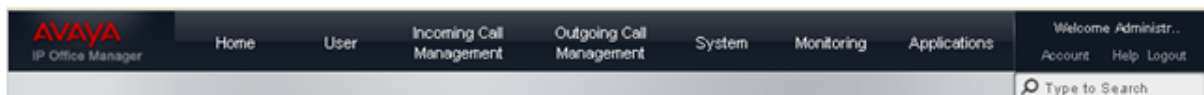

The following menus are available in the IP Office Web Manager:

### Home

A new concept of a homepage or dashboard lets the administrator see a full system view in a graphical way.

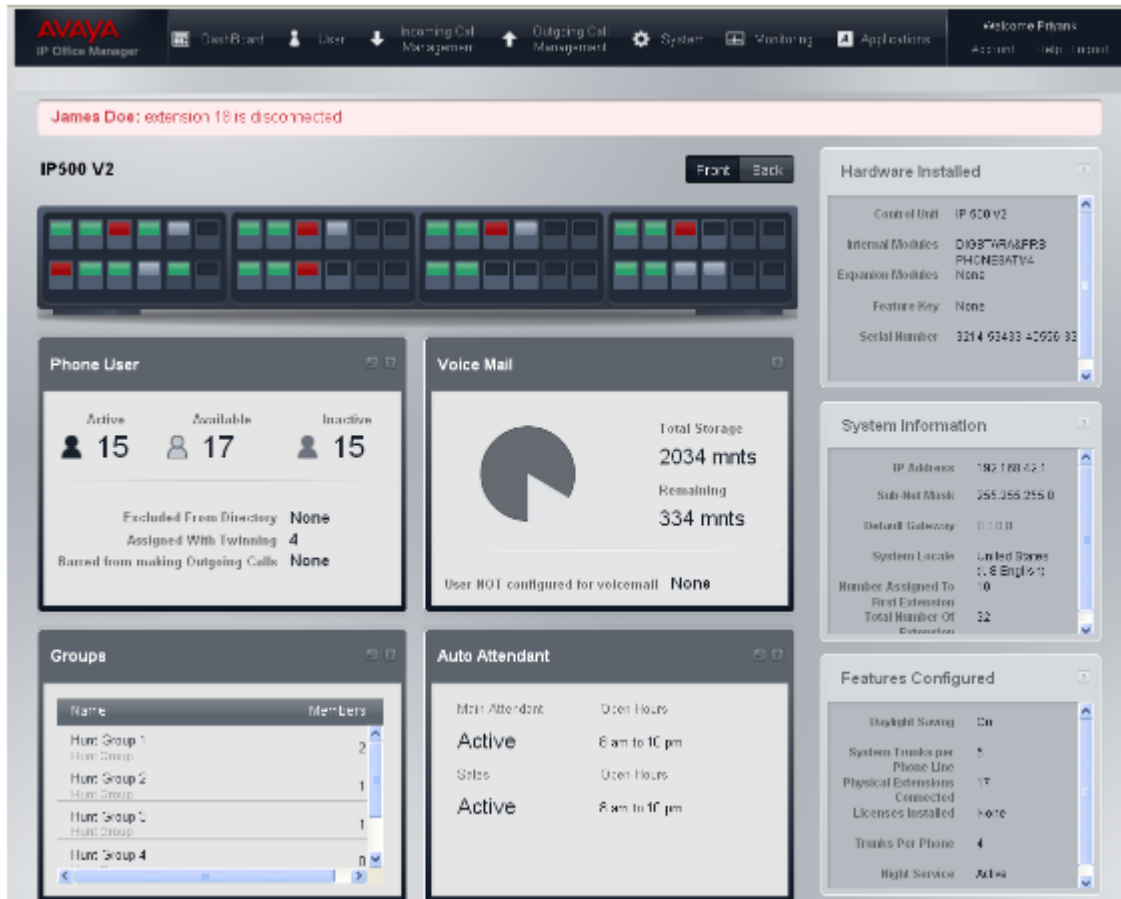

### Graphical System View

The logical view of the system includes port status LED lights. Following are the system LED status indicators:

1. Green – Port is connected and correctly configured.
2. Red – Port is connected but is either not correctly configured or is down.
3. Grey – Port is not connected and is available.

Mouse over the LED to display a pop-up with the configured user with name and extension number. The particular user configuration can be edited directly by clicking on the pop-up.

### Critical Message Bar

A critical message bar displays any critical alarms. Upon clicking on the message, the administrator will be taken directly to the relevant configuration page for any debugging.

### Static System Information

The three system status indicators on the right display the installed HW, System information and configured features.

### Dynamic feature Information

The four feature information tabs display detailed configuration status on voicemail, hunt group, users and auto attendant.

### User

The user configuration is extracted and available as a separate tab item because it's one of the most used features during initial system configuration as well as for adds, moves and changes.

There are two levels of user settings: "Basic" and "Advanced".

### Basic User Screens

The basic user screens let the administrator configure the basic parameters associated with the users including name, extension, language, twinned number and more. The IP Office would work fine by just configuring the basic parameters and does not need the administrator to ensure any "Advanced" configuration parameters. The Basic user screens provide a "quick" view and "detail" view for users.

AVAYA IP Office Manager Dashboard User Incoming Call Management Outgoing Call Management IP Office Monitoring Applications Welcome admin Account Help Logout

<< Back

### Phone User List

Export Import New User

Type to search

Name	Extension	Groups	
Apoorva	201	Runt Group 1,Runt Group 2	<a href="#">View Details</a>
David	202	Runt Group 1,Runt Group 3	<a href="#">View Details</a>
Richards	203	undefined	<a href="#">View Details</a>
Tom	203	undefined	<a href="#">View Details</a>
Mary	204	undefined	<a href="#">View Details</a>
James	205	undefined	<a href="#">View Details</a>
John	206	undefined	<a href="#">View Details</a>
Jill	207	undefined	<a href="#">View Details</a>
Robert	208	undefined	<a href="#">View Details</a>
Tim	209	undefined	<a href="#">View Details</a>

#### Default Button Programming

Hand set: Avaya 1495

Labels: Line 1, Line 3, Line 4, Line 5, Line 6

[Print Label](#)

**Edit...**

#### Incoming Calls

Group: Evening Calls, Cell Phone Support, Call Support

**Edit...**

#### Outgoing Calls

Lists: Allowed User, Disallowed User

**Edit...**

AVAYA IP Office Manager Dashboard User Incoming Call Management Outgoing Call Management IP Office Monitoring Applications Welcome admin Account Help Logout

<< View All Users

### Edit Apoorva

Delete User ✕

**Apoorva** Ext. 201 Direct ID (415)954-5542 Twinned 9445544443  
Groups: Runt Group 1, Runt Group 2

#### Phone User

Name:

Extension:

Email:

Calling Line Identity:

Direct ID:

Twin Phone:  Yes  No

(999)999-9999

Give System Access:  Yes  No  
Allows user access the system and edit settings

**Advanced**

#### Voicemail

Automatic VMS Cover:

Voicemail Code:

Show Code

Send to Email:

#### Details

List in Directory:  Yes  No

Calls Barred:  Yes  No  
Blocks all outgoing calls

Language:

#### Default Button Programming

Hand set: Avaya201

Labels: Line 1, Line 3, Line 4, Line 5, Line 6

[Print Label](#)

**Edit...**

#### Incoming Calls

Group: Evening Calls, Cell Phone Support, Call Support

**Edit...**

#### Outgoing Calls

Lists: Allowed User, Disallowed User

**Edit...**

**Cancel Save**

### Advanced User Screen

For more sophisticated use of the system, the administrator can then go to the "Advanced" screen by clicking the "Advanced" button at the bottom of the user screen.



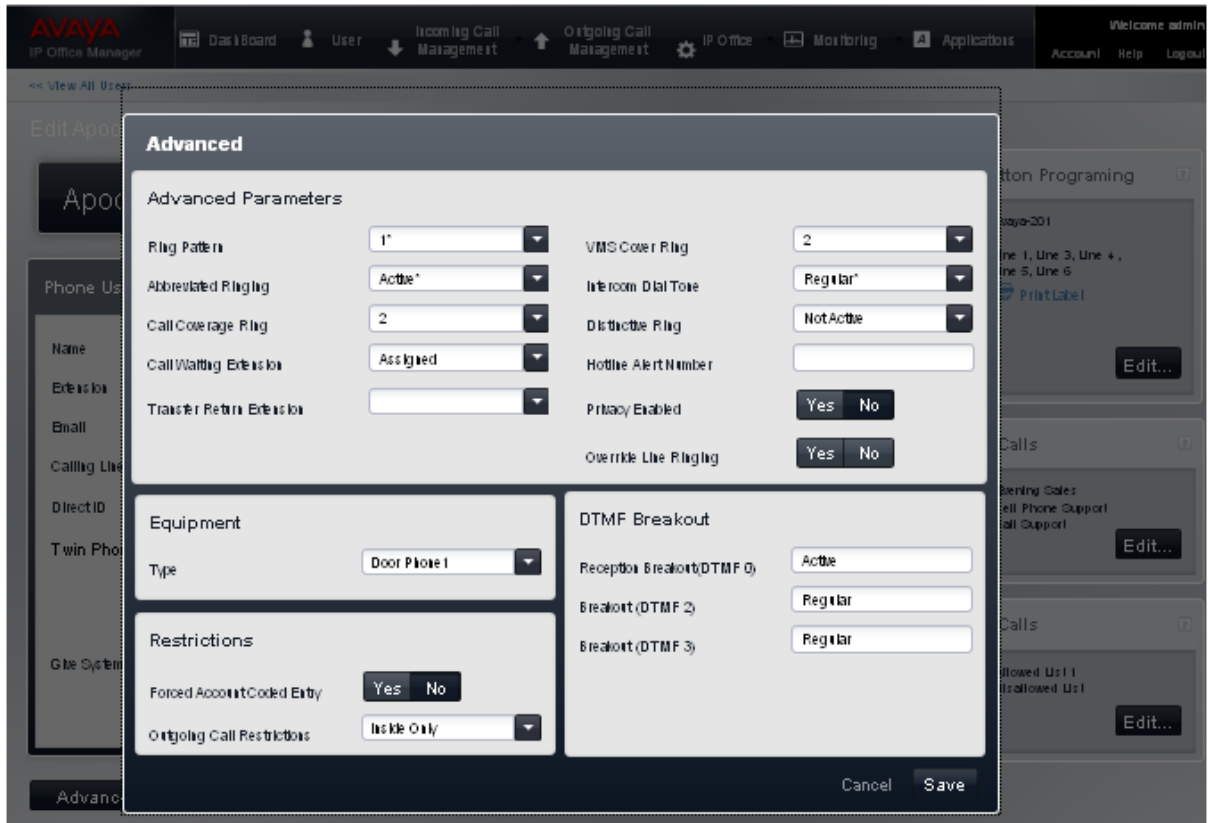

### Incoming Call Management

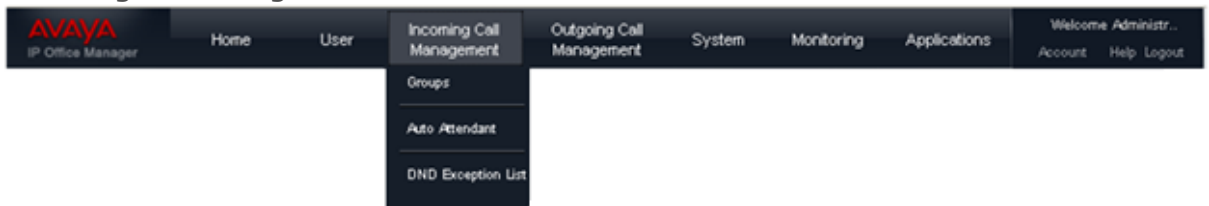

The incoming call management tab includes "Groups", "Auto Attendant", and "DND Exception List".

### Outgoing Call Management

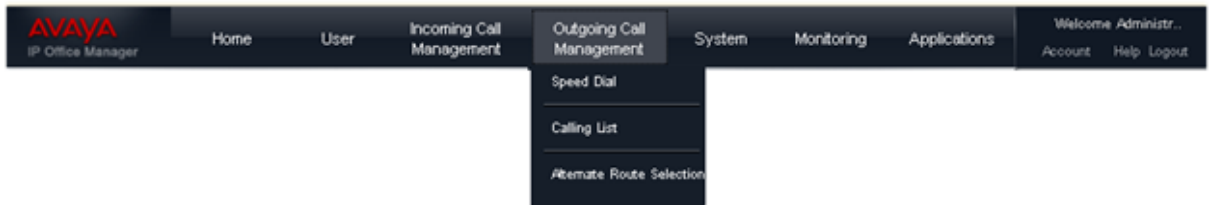

The outgoing call management tab includes "Speed Dial", "Calling List", and "Alternate Route Selection".

### System

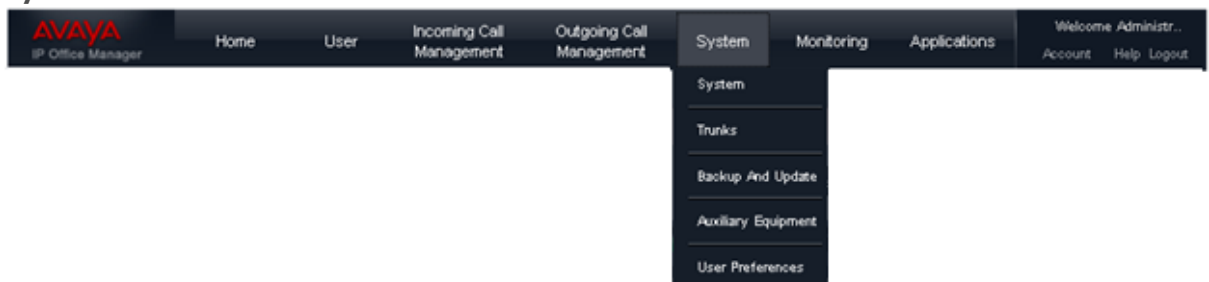

The System tab includes "Switch", "Trunks", "Backup and Update", "Auxiliary Equipment", and "User Preferences".

## Monitoring

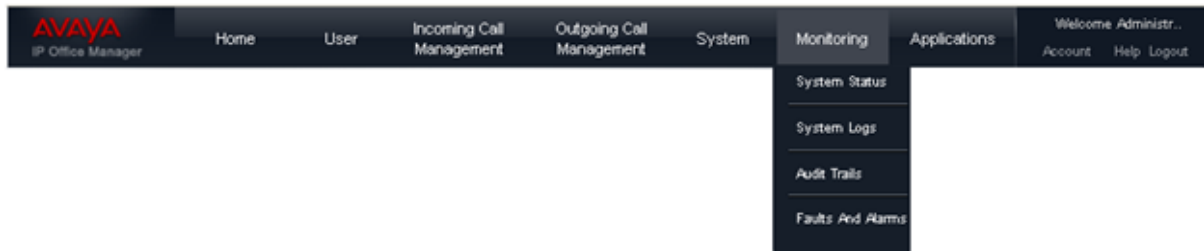

The monitoring tab includes four menu items: "System Status", "Faults and Alarms", "System Logs", and "Audit Trails". The System Status application is directly launched as an applet.



## Applications

The Applications tab includes "Voicemail" configuration.

## Role Based Administration

IP Office Web Manager supports role based administration. Super user logs on to the system using system default username and password. The Super User can then add more administrators with different read/write privileges.

## Search

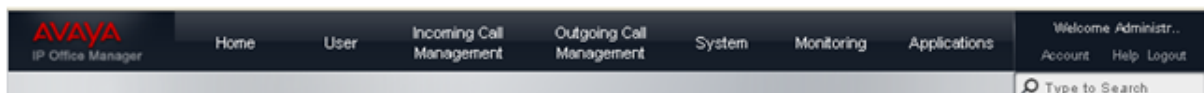

A system level "search" functionality is available as part of the Title Menu Bar.

## Import/Export

Many features within the new IP Office Web Manager support import and export capabilities using .csv and .xml. This lets the administrator prepare the information before hand (i.e. ask the customer to provide an excel sheet with user names, extensions and features) and simply import to complete the system configuration.

## Back-up, Restore, and Upgrade

In IP Office Release 8.1+, Web Manager is enhanced to include new Back-Up, Restore, and Upgrade functionality.

- **Back-up:**

A back-up image from the system/primary directory on the SD card can be sent to the SD Card system back-up or to the local machine that is running the browser. In the latter case, Web Manager will download a java applet to interact with the local file system.

- **Restore:**

Existing back-up files can be restored to the "system/primary" directory of the SD card. Restores can be made from the "system/backup" to the "system/primary" of the SD card or from the local machine that is running the browser. Web Manager downloads a java applet to interact with the local system. All restores will require a system reboot.

- **Upgrade:**

The upgrade package will be installed on the machine that is running the browser. Web Manager will interact with the IP Office to install the upgrade. The system will require a reboot after the system upgrade.

## Help

The IP Office Web Manager provides intuitive help. There is pop-up help when the user tries to configure a non-supported config. Also if a parameter value is not valid, the configuration window becomes "red" and the "Save" button is automatically grayed out prevents invalid configurations from getting saved. Quick Inline editing also helps configure/change settings easily.

# IP Office Simplified Manager

IP Office Essential Edition operates in two modes, namely Quick Mode and Standard Mode (Standard mode is the current mode of operation of IP Office). Essential Edition - Quick Mode is managed by the Simplified Manager, designed to reduce the installation times, specifically for Sub-20 deployments.

In IP Office Release 8.0, the 500v2 will initially boot-up in Quick Mode. An option in IP Office Manager is provided to switch IP Office to Standard Mode as default.

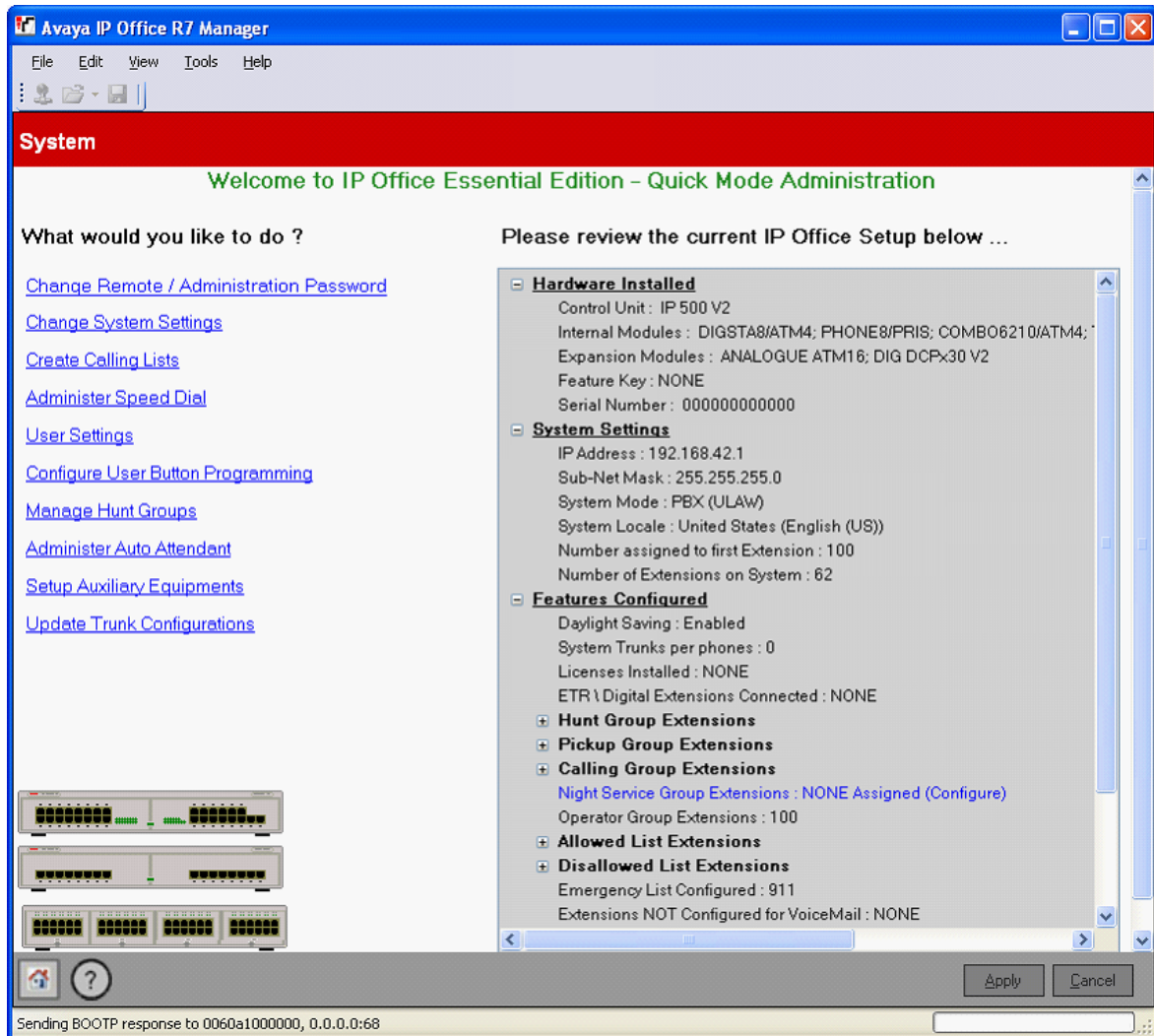

IP Office has a built-in audit trail that tracks changes to the system configuration, and who has made them. Manager can display the audit trail to assist with problem resolution. The audit trail records the last 15 changes in the configuration and records the following elements:

- Configuration Changed - For configuration changes, the log will report at a high level on all configuration categories (users, hunt group...) that have been changed.
- Configuration Erased
- Configuration merged
- Reboot – user instigated reboot
- Upgrade
- Cold Start
- Warm Start
- Write at HH:MM – This is when the administrator saved the configuration via the schedule option
- Write with Immediate Reboot
- Write with Reboot When Free

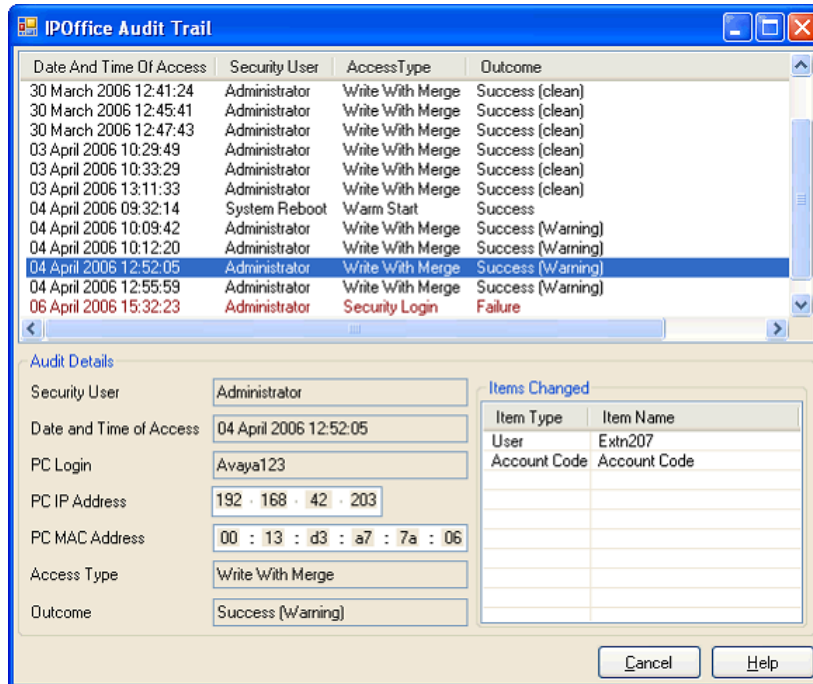

IP Office Manager is also used for maintenance functions such as:

- Upgrade to the IP Office system software
- Systems running 2.1 or later have the added benefit of being able to send software over an IP network link to a system and have it validated before committing to the upgrade
- IP Office Manager Release is backwards compatible with systems from Release 2.1 onwards to allow a single management application
- Importing and Exporting IP Office configuration information in ACSII-CSV files. Manager will create files for the following data:
  - Configuration.csv which is a complete list of items as per IP Office Manager and earlier
  - Directory.csv containing fields NAME, NUMBER
  - HuntGroup.csv containing fields HUNT GROUP NAME, HUNT GROUP EXTENSION, GROUP, HUNT, ROTARY, IDLE, QUEUING, VOICEMAIL, BROADCAST MESSAGES, EMAIL ADDRESS
  - License.csv is import only containing fields LICENCE OPTION, LICENCE KEY
  - ShortCode.csv containing fields SHORT CODE, TELEPHONE NUMBER, FEATURE NAME
  - User.csv containing fields NAME, EXTENSION NUMBER, USER RIGHT, EMAIL ADDRESS
  - User templates for rapid programming and user rights for setting up user access levels

# IP Office Monitor

The IP Office Monitor application is a real-time maintenance utility to assist with IP Office trouble-shooting. As the application connects to the IP Office over an IP connection it can be used from both local (LAN) and remote locations (WAN).

A simple interface allows an engineer to select which protocols and interfaces are to be monitored and decoded. The trace can either be captured directly to screen or as a log file for later analysis. Traces from different protocols can be color coded to improve the clarity of large log files. In addition to monitoring, the application captures system alarms and will display an activity log of the last 20 alarms that have occurred.

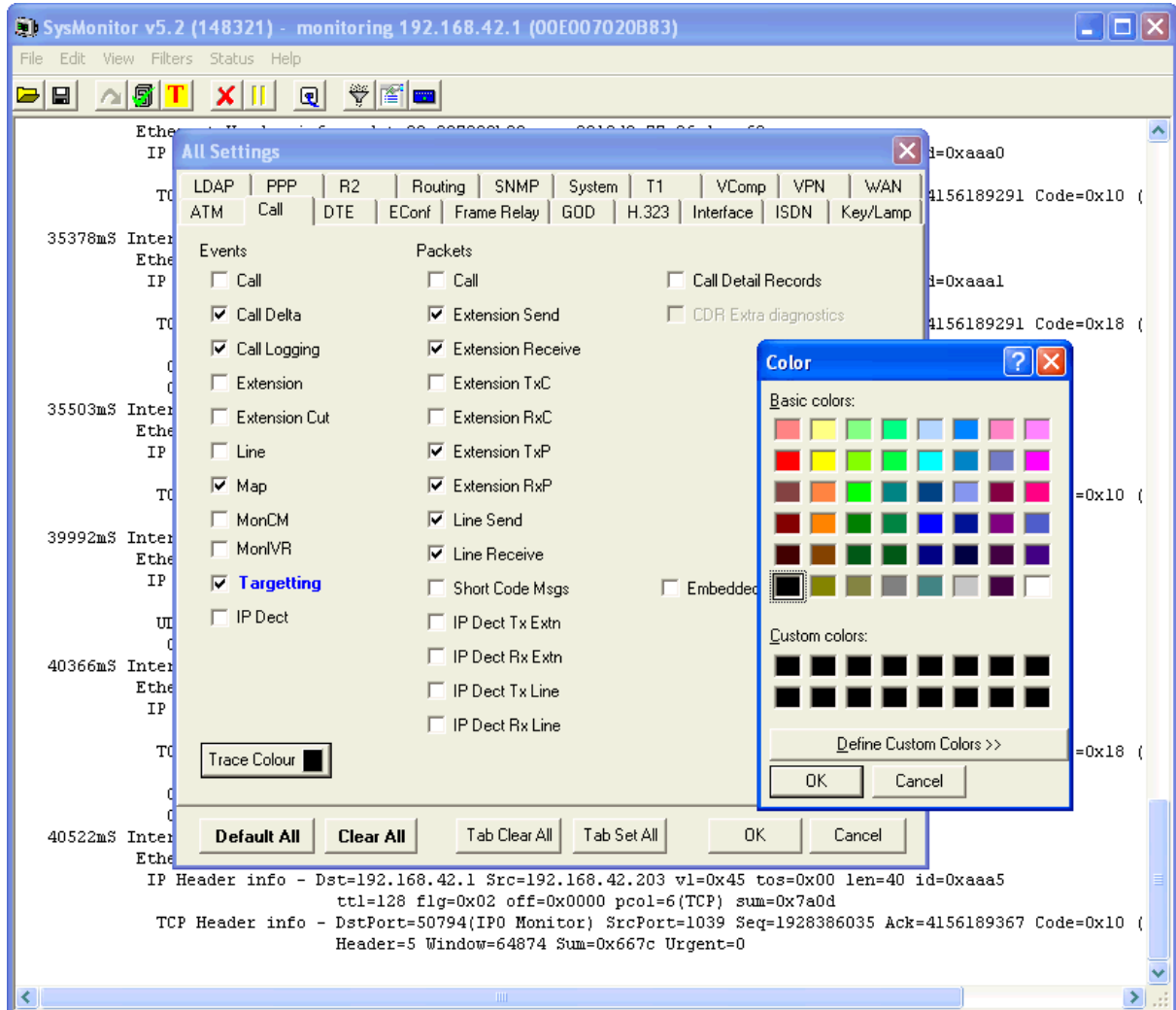

# Simple Network Management Protocol (SNMP)

SNMP is an industry standard designed to allow the management of data equipment from different vendors using a single Network Manager application. The Network Manager will periodically poll equipment to solicit a response, if no response is received an alarm is raised. In addition to responding to polls, IP Office monitors the state of its Extensions, Trunk cards, Expansion Modules and Media cards so that if an error is detected IP Office will notify the Network Manager. IP Office allows two separate Network Managers to be configured so that both a customer's Network Manager and a Maintainers Network Manager to be notified of the same alarm condition. As the IP Office solution comprises many applications, the core software notifies SNMP events from both Voicemail Pro and Embedded Voicemail to warn of approaching storage capacity limits.

IP Office has been tested against CastleRock's SNMPc-EE™ and HP's Network Node Manager (part of the OpenView application suite).

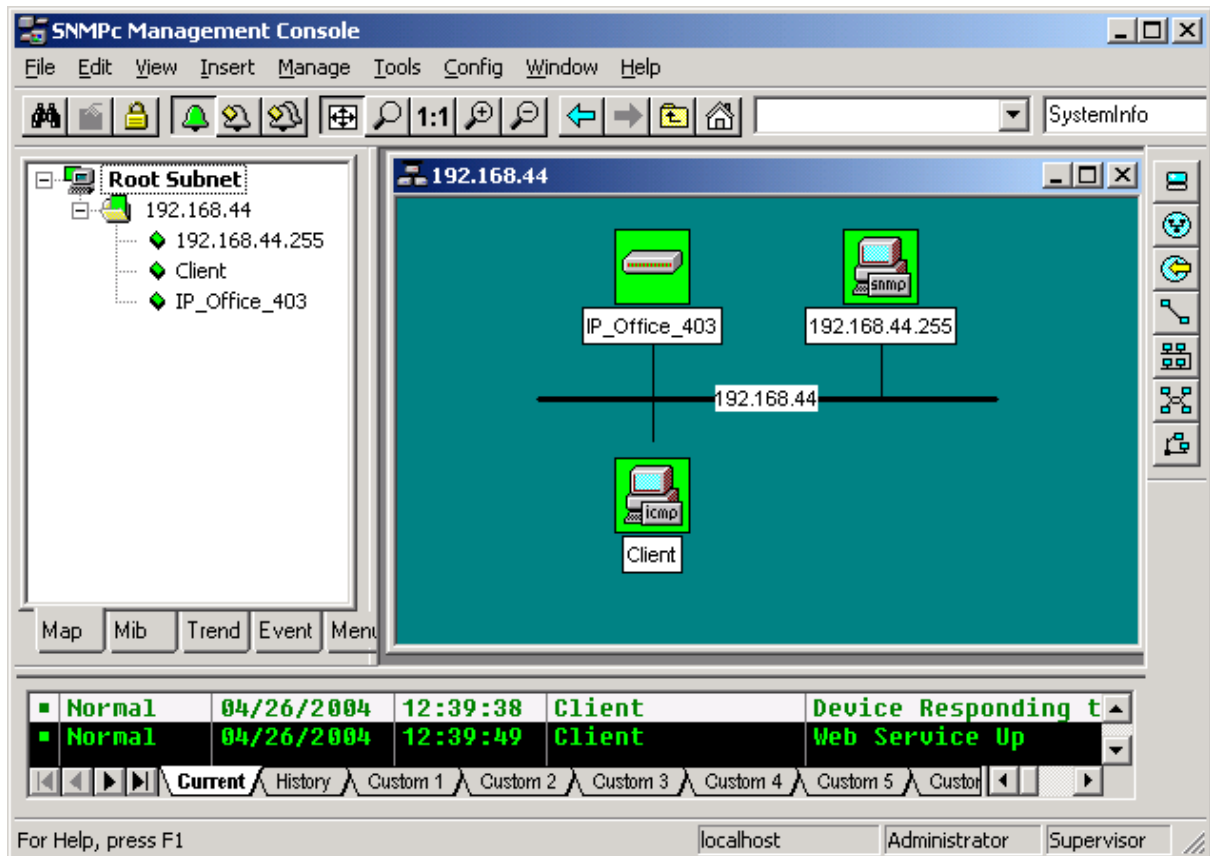

On customer sites where SNMP management is not available, IP Office can email events using up to 3 email addresses each containing a different set of alarms. The following system event categories can be chosen for email notification, if installed on the system:

- **Generic**
- **Trunk lines**
- **Embedded Voicemail Card**
- **VCM**
- **Expansion modules**
- **Applications**
- **License**
- **Phone change**
- **CSU Loop-Back**

IP Office sends email notifications directly to the email server; no additional PC client is needed.

# System Status Application

The System Status Application (SSA) is a diagnostic tool for system managers and administrators to monitor and check the status of IP Office systems locally or remotely. SSA shows both the current state of an IP Office system and details of any problems that have occurred. The information reported is a combination of real-time events, historical events, status and configuration data to assist fault finding and diagnosis. SSA provides real-time status, historic utilization and alarm information for ports, modules and expansion cards on the system. SSA connects to all variants of IP Office running Release 4.0, using an IP connection that can be remote or local. Modem connections at 14.4kbps or above are supported for remote diagnostics.

SSA provides information on the following:

- **Alarms**  
SSA displays all alarms which are recorded within IP Office for each device in error. The number, date and time of the occurrence is recorded. The last 50 alarms are stored within IP Office to avoid need for local PC.
- **Call Details**  
Information on incoming and outgoing calls, including call length, call ID and routing information.
- **Extensions**  
SSA details all extensions (including device type and port location) on the IP Office system. Information on the current status of a device is also displayed.
- **Trunks**  
IP Office trunks and connections (VoIP, analog and digital) and their current status are displayed. For VoIP trunks, QoS information is also displayed (e.g. round trip delay, jitter and packet loss).
- **System Resources**  
IP Office includes central resources that are utilized to perform various functions. Diagnosing these resources is often critical to the successful operation of the system. This includes details on resources for VCM, Voicemail and conferencing.
- **QoS Monitoring**  
QoS Parameters from connected calls, such as jitter and roundtrip delay, are monitored.

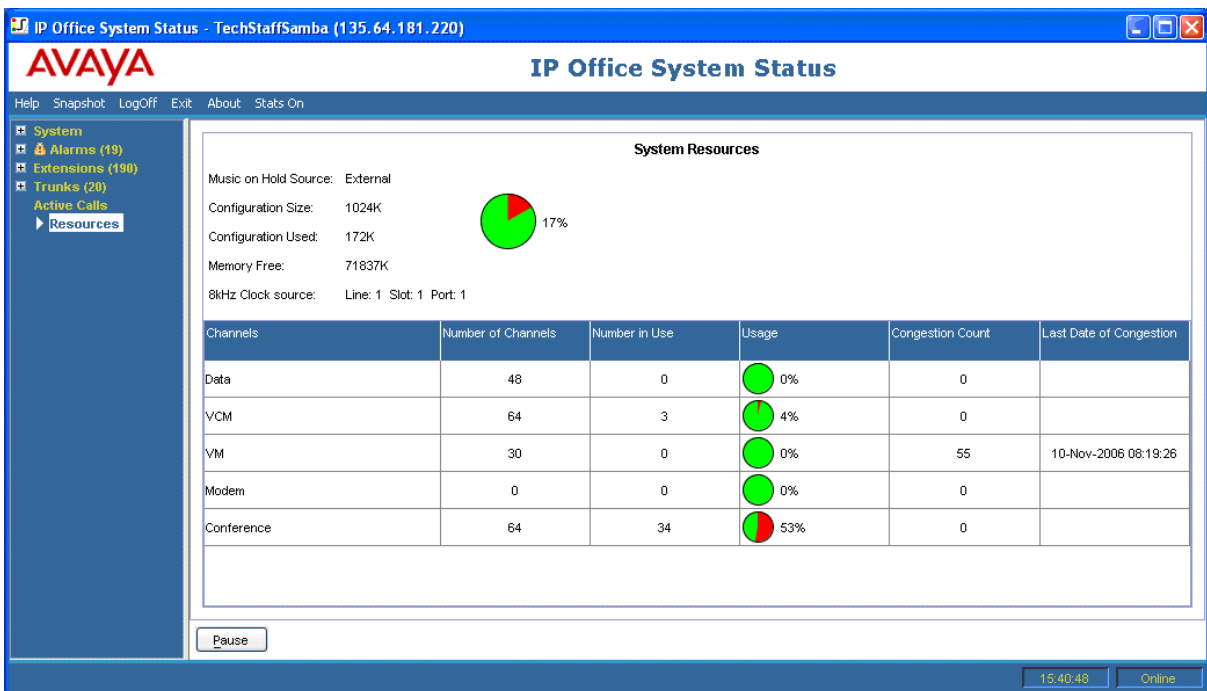

SSA can be launched independently or from IP Office Manager and there can be up to two (2) SSA clients connected to an IP Office unit at one time.

Note: SSA is not a configuration tool for IP Office systems.



# Data Migration Manager

IP Office Release 8.0 introduces a new tool called the Data Migration Manager (DMM) designed specifically to facilitate quick and easy migration from BCM and Norstar™ to IP Office. There are three steps in the migration process: Extract, Convert and Apply.

DMM will migrate:

- Announcements and greetings
- Voicemail messages
- Extract Call Pilot configuration

This will create a strong competitive advantage and reduce the installation times significantly.

**Step 1 - Extract:** This step involves specification of the source from which you intend to extract the configuration data file as well as other data including voicemails, greetings, recorded names etc.

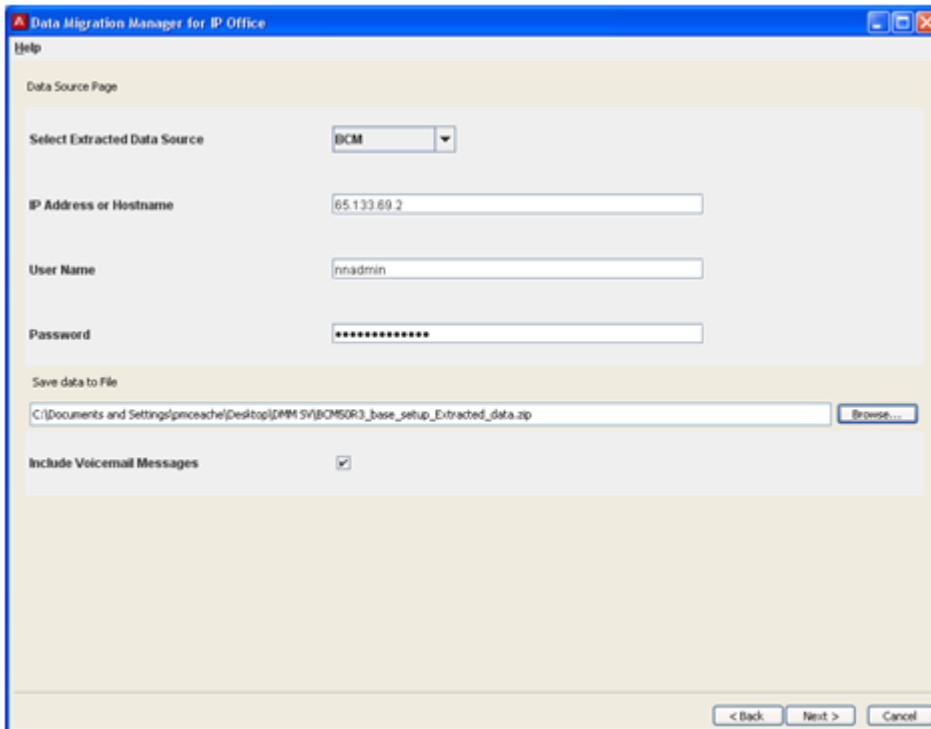

**Step 2 - Convert:** This step involves converting the data in the format of the source product to the format of the destination product. I.e. convert data that is understood by BCM to data that is understood by IP Office.

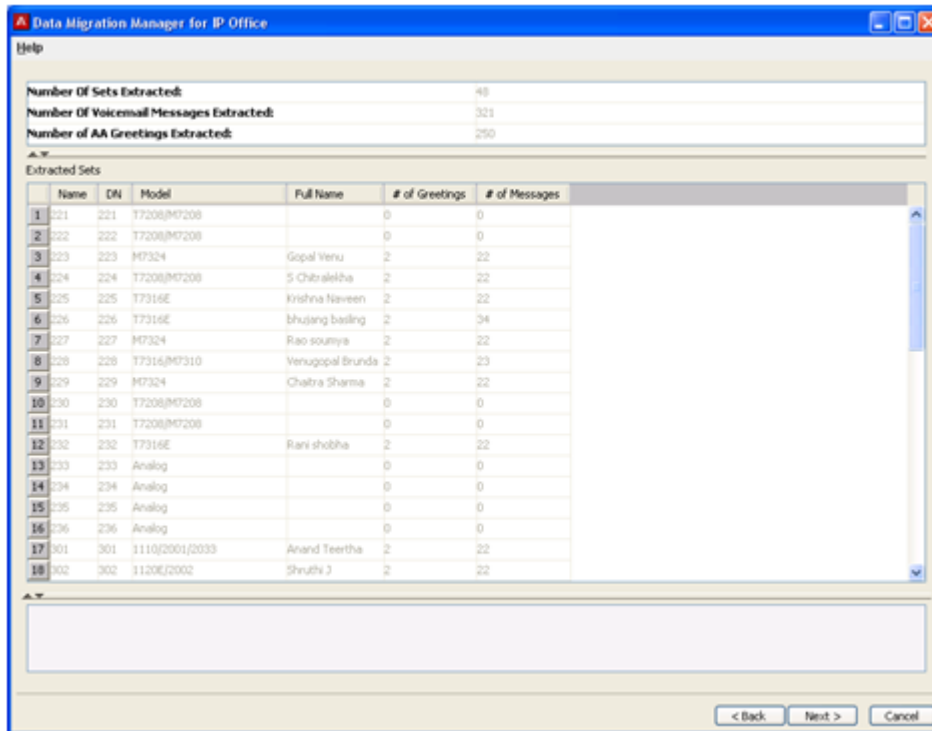

**Step 3 - Apply:** This step involves applying the configuration to the destination product, which is always IP Office.

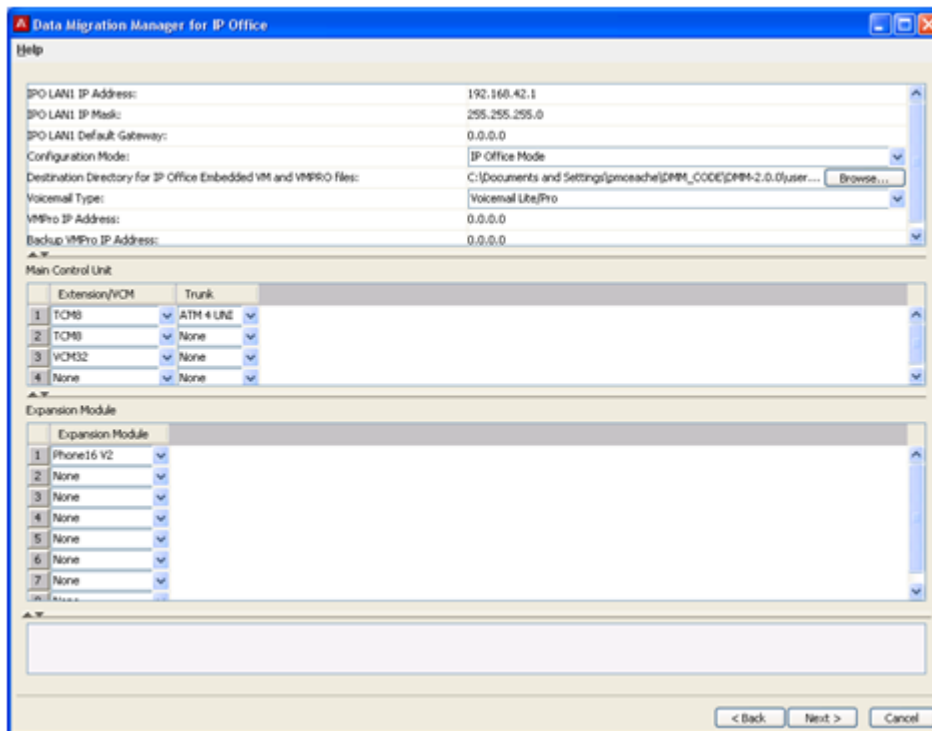

Supported models include the following:

**BCM**

- BCM200 4.0
- BCM400 4.0
- BCM1000 4.0
- BCM50 3.0, 5.0, 6.0
- BCM450 1.0, 5.0, 6.0

**Norstar**

- CICS, MICS 7.x
- Call Pilot 100/150 3.1

**IP Office 7.0** and later

- Standard Mode
- Norstar Mode
- PARTNER Mode

IP500 V2 control unit required



# **Chapter 20.**

# **IP Office Support Services**

# **and Automated**

# **On-Boarding**

# 20. IP Office Support Services and Automated On-Boarding

## Avaya Global Services

### Introducing Avaya IP Office Support Services

With the introduction of IP Office Release 8.1, Avaya launched a new service offering. Avaya IP Office Support Services provides service options designed to maintain and support Customers' IP Office.

The charts below provide a brief overview of the new service offering. For additional details of the new Avaya IP Office Support Services offering, please refer to the Global Offer Definition document and other launch materials located online, at <http://portal.avaya.com/ptlWeb/qs/services/SV0578>.

### New Global Offer from Avaya

**IP Office Support Services are consistent, flexible and simple**

- ▶ Single fee per node\*
- ▶ Base offer includes:
  - Remote Technical Support (Hardware and Software)
  - Business Hour Support – 8x5x5
  - Major Software Upgrades
  - Software Patches and Updates
  - Enhanced Remote Connectivity
  - 1, 3 or 5 year prepaid terms

Optional Add-Ons

**Any Time / Any Day Support  
24x7x365**

**Parts Replacement  
NBD or 4 hour  
or On-site (US)**

**Terminal Replacement**

Consistent

Same offer elements for SME and Mid Market

Flexible

Multiple service delivery options available

Simple

Industry standard support model at a fixed price

### IP Office Support Services Key Offer Benefits

**Partners protect their customers with a Maintenance Support offer upfront at point of sale**

Consistent

Same offer elements for SME and Mid Market

- ▶ Remote Technical Support (Hardware and Software)
- ▶ Major Software Upgrades
- ▶ Software Patches and Updates
- ▶ One low service rate, regardless of product complexity or number of calls

Flexible

Multiple service delivery options available

- ▶ Wholesale and Co-Delivery options
- ▶ Business Hour Support (8x5x5) or Any Time / Any Day Support (24x7x365)
- ▶ Enhanced remote connectivity (SSL / VPN) for faster resolution
- ▶ Partner or customer can call Avaya
- ▶ 1, 3 or 5 year prepaid terms
- ▶ No required attach

Simple

Industry standard support model

- ▶ Easy to quote – use Price Catalog, Distributor Tools, EZ Quote or EC Voice
- ▶ Easy to order – use existing SME order forms
- ▶ Tools and Process enhancements delivered with launch
- ▶ Limited material codes

Applies to IP Office 8.1+ and is available through authorized partners and 2-Tier Distribution (older releases remain on BOH)

**Note:** IP Office Support Services will be the only Manufacturers Support Offer available on IP Office Release 8.1 and future releases. The Block of Hours offer (SME Technical Support for Partners) will remain available on legacy products (including IP Office Release 8.0 and earlier versions). IP Office Support Services for IP Office Release 8.1 is recommended but it is not mandatory.

### Avaya Maintenance, Lifecycle and Warranty Information

Avaya IP Office Support Services complements standard Avaya maintenance, life cycle, and warranty policies which are posted on [support.avaya.com](http://support.avaya.com)

### Additional Avaya IP Office Support Services Information

For additional details of the new Avaya IP Office Support Services offering, please refer to the Global Offer Definition document and other launch materials located at <http://portal.avaya.com/ptlWeb/qs/services/SV0578>.

---

## On-Boarding Automation

---

The new maintenance offer for Avaya IP Office Support Services requires the completion of some simple administrative steps to facilitate service delivery. On-boarding of the specific IP Office system is required to create an installed base inventory record in the Global Registration Tool (GRT) and, where supported and requested, the establishment of SSL/VPN remote connectivity into the Avaya support infrastructure, termed 'technical registration.'

To create a more streamlined and integrated process, Release 8.1 introduces several automation elements to the On-Boarding process within Web Manager and available for use with IP Office Basic, Standard, and Server editions. The **On-Boarding** option in the **Tools** drop down menu opens up the On-Boarding page.

The On-boarding menu guides the user through the required steps listed briefly below:

1. The **Get Inventory File** option extracts the IP Office inventory from the configured IP Office into an inventory .xml file which is stored on the user's laptop or system.
2. From the user's browser, click the **Register IP Office** button to proceed directly to the IP Office Global Registration Tool (GRT) landing page.
3. The user logs into GRT with their SSO log-in credentials, entering the specific customer 'Sold To' and other site-specific information.
4. The IP Office inventory file is then uploaded into GRT, which will then use this information to create the installed base inventory record.
5. If the user has requested remote access into Avaya, then GRT will automatically generate an SSL/VPN Onboarding.xml file which is downloaded to the machine running the web browser.
6. The Onboarding.xml file is uploaded to the IP Office by clicking on the **Upload** button located in the 'Upload On-Boarding' file area.



The screenshot displays a web-based interface titled "On-boarding" with three distinct sections. The first section, "Inventory", contains a checkbox labeled "Are you using TAA series hardware?" and a "Get Inventory File" button. The second section, "Registration", features a "Register IP Office" button. The third section, "Upload On-boarding File", includes a "Select File" input field, a "Browse" button, and an "Upload" button. A "Close" button is located at the bottom right of the interface.

After completing the steps outlined above, the inventory installed base creation and the technical registration to establish SSL/VPN connection into the Avaya services infrastructure is now completed.

**Note:** Some exceptions and conditions apply to the On-Boarding Automation tools as they are described above:

- Not supported on the IP Office 500v1 system.
- Not supported on the external expansion applications server (Material Code – 26981026) used with the IP Office, as no core processing runs on this server. To facilitate completion of necessary GRT registration, the Web Control contains the material code for quick reference.

- Telephone inventory information is required since optional telephone APR coverage is not available in the inventory file that is automatically extracted.
- To ensure the most accurate inventory file, the system should be fully configured before starting the registration process in GRT.
- The auto-extracted inventory file utilizes a "best match" approach to identify the corresponding hardware material code. GRT provides users an opportunity to review and make adjustments to the final installed base inventory record in situations where the "best match" does not accurately reflect the actual site installation configuration.
- After completing the initial on-boarding process, the extracted inventory file can be generated again in the future to capture any changes to the system configuration. This can be useful for ongoing service or troubleshooting.

Always refer to the IP Office Support Services offer description and process training materials for the most current details of these and other process requirements required for maintenance coverage.



# Chapter 21.

# Technical Specifications

# 21. Technical Specifications

PC requirements and specifications of the various IP Office applications can be found in a separate document in the IP Office section of [support.avaya.com](http://support.avaya.com).

## Dimensions

Unit Dimensions (mm/inches)	Width	Height	Depth
IP500 and IP500 V2	445mm/17.5"	73mm/2.9"	365mm/14.4"

- The recommended minimum clearance, front and rear, for the connection of cables and other devices is 75mm/3".

## Weight

Unit	Weight
IP500 Control Unit	3.2Kg/7.0lbs
IP500 V2 Control Unit	3.2Kg/7.0lbs
IP412 Control Unit	3.0Kg/6.7lbs
Analog 16 Module	2.9Kg/6.5lbs
DS16 Module	3.0Kg/6.7lbs
DS30 Module	3.5Kg/7.8lbs
DS16A Module	3.0Kg/6.7lbs
DS30A Module	3.5Kg/7.8lbs
TCM8	0.4Kg/0.9lbs
WAN3 Module	2.8Kg/6.3lbs
So8 Module	2.8Kg/6.3lbs
Phone 8 Module	2.8Kg/6.3lbs
Phone 16 Module	2.9Kg/6.5lbs
Phone 30 Module	3.1Kg/6.94lbs

## Environmental

- 0°C to +40°C (32°F to 104°F). 95% relative humidity, non-condensing.

## Call Capacity

Busy Hour Call Complete (BHCC) is a measure used to test IP Office systems under a high call load. For BHCC tests, each incoming call rings for 5 seconds, is answered and stays connected for 6 seconds. The BHCC figures for the different IP Office control units are listed below. Note that in some cases the BHCC figure achievable will be limited by the number of incoming trunks supported.

- IP500 = 36000.
- IP500 V2 = 36000.

## Telephone Extension Cable Lengths

The following table details the maximum cable lengths supported for the telephone ranges. These figures assume that standard twisted-pair telephone cable or CAT5 network cable is used.

Telephone	Unshielded Twisted-Pair (UTP) - 50nf/Km			CW1308
	AWG22 (0.65mm)	AWG24 (0.5mm)	AWG26 (0.4mm)	
1600/9600 Series	NA determined by network	NA determined by network	NA determined by network	NA determined by network
1400 Series	1200m/3937'	1000m/3280'	670m/2200'	400m/1310'
5400 Series	1200m/3937'	1000m/3280'	670m/2200'	400m/1310'
T3 Series (UPN)	1000m/3280'	1000m/3280'	400m/1310'	-
Analog telephones	1000m/3280'	1000m/ 3280'	400m/1640'	800m/2620'

## Heat Dissipation

Note that the above numbers are for reference only. For practical purposes, for example the calculation of heat dissipation, it is recommended to base environmental requirements (for example air cooling or UPS ratings) on the maximum input rating of the power supplies of the planned IP Office configuration, as follows.

In order to calculate the maximum, that is worst case, amount of heat that can be generated by an IP Office system, it is assumed that all input power is converted to heat; whether from the PSU itself, the system unit, expansion module and/or cabling.

Heat dissipation is normally measured in British Thermal Units (BTU's). A heat value expressed in Watts can be converted to BTU/hr by multiplying by 3.41297. As indicated above, you should use the maximum power input of 115 VA of each power supply to calculate this most accurately.

Using the conversion factor:

- Heat Dissipation =  $115 \times 3.41297 = 392.5$  BTU/hour.

The metric equivalent to BTU is a Joule where 1 BTU = 1,055 Joules.

This calculates the BTU value per power supply. The maximum BTU per system is therefore calculated, based on total number of power supplies installed in the system.

- IP500 V2 Maximum Heat Dissipation =  $13 \times 392.5 = 5,103$  BTU/hr.

Remember to budget for the power requirements of any additional devices that are to be co-located with the IP Office such as server PC's (voicemail, etc).

## Power Supply

- **Input**

- **IP Office 500 V2 and IP Office 500 System Unit:** IEC AC inlet socket. 100-240V AC, 50/60Hz, 81-115VA, 2.5A maximum.

- **Power Supply Units:** All CE/UL/Dentori Safety Approved.

- **Standard 40W Power Supply Unit** (All control and expansion units unless otherwise indicated)  
Supplied with the control or expansion unit. 40W PSU with integral lead to the unit. Connection to switched mains supply requires separately supplied country specific IEC 60320 C7 power cord (2-wire figure 8 connector).

- **Input:** 100-240V AC, 50/60Hz, 81-115VA, 2A maximum.

- **Output:** 24Vdc, 1.875A, output power 45W maximum.

- **IP Office 500 80W internal Power Supply**

Integral to the System Unit. Connection to switched mains supply requires separately supplied country specific IEC 60320 C13 power cord (3-wire earthed cold kettle lead).

- **Input:** 100-240V AC, 50/60Hz, 81-115VA, 2.5A maximum.

## Interfaces

Interface	Information
<b>DTE Port</b>	<ul style="list-style-type: none"> <li>9 way D-type D-Type female connector: V.24/V.28.</li> </ul>
<b>ISDN Ports</b>	<p><b>EU Interfaces:</b></p> <ul style="list-style-type: none"> <li>BRI: RJ45 sockets. ETSI T-Bus Interface to CTR3 for Pan European Connection.</li> <li>PRI E1: RJ45 socket. ETSI T-Bus Interface to CTR4 for Pan European Connection.</li> <li>PRI T1/J1: RJ45 socket: FCC Part 68/JATE connection.</li> </ul> <p><b>USA Interfaces:</b></p> <ul style="list-style-type: none"> <li>PRI T1 Service: Ground Start (GS) – Default, E&amp;M, 56k data for 5ESS, 56/64/64 restricted for 4ESS.</li> <li>PRI ISDN Switch support: 4ESS, 5ESS, DMS-100, DMS-250 (includes conformance to ANSI T1.607 and Bellcore Special Report SR4287, 1992).</li> <li>PRI ISDN Services: AT&amp;T Megacom 800, AT&amp;T WATS (4ESS), AT&amp;T SDS Accunet 56kB/s and 64kB/s (4ESS), AT&amp;T Multiquest (4ESS).</li> </ul>
<b>Analog Trunk Ports</b>	<ul style="list-style-type: none"> <li>RJ45 sockets: Loop start/Ground start (regional dependant)</li> </ul>
<b>Power Fail Ports</b>	<ul style="list-style-type: none"> <li>RJ45 sockets:</li> </ul>
<b>ISDN Data Rates</b>	<ul style="list-style-type: none"> <li>BRI: B-channel 64kbps or 56kbps, D-channel 16kbps.</li> <li>PRI: B-channel 64kbps or 56kbps, D-channel 64kbps.</li> </ul>
<b>Analog Phone Ports</b>	<ul style="list-style-type: none"> <li>RJ45 sockets</li> <li>REN: 2. (External Bell via POT port: REN = 1)</li> <li>Off Hook Current: 25mA.</li> <li>Ring Voltage: 40V (nominal) RMS.</li> </ul>
<b>LAN</b>	<ul style="list-style-type: none"> <li>RJ45 sockets. Auto-negotiating 10/100 BaseT Ethernet (10/100Mbps).</li> </ul>
<b>WAN</b>	<ul style="list-style-type: none"> <li>IP406 V2 and IP412: 37 way D-Type female sockets. X.21 interface to 2048k bps, V.35 interface to 2048Kbps and V.24 Interface to 19.2Kbps.</li> </ul>
<b>Audio</b>	<ul style="list-style-type: none"> <li>3.5mm Stereo Jack socket. Input impedance - 10k /channel.</li> <li>Maximum AC signal – 200mV rms.</li> </ul>
<b>External Output Port</b>	<ul style="list-style-type: none"> <li>3.5mm Stereo Jack socket. Switching Capacity - 0.7A.</li> <li>Maximum Voltage - 55V DC. On state resistance - 0.7.</li> <li>Short circuit current - 1A. Reverse circuit current capacity - 1.4A.</li> </ul>
<b>Embedded Voice Memory</b>	<ul style="list-style-type: none"> <li>IP406 V2 and IP500: 512MB Compact Flash memory card.</li> </ul>

## Protocols

Protocol	RFC	Information
V120	-	A standard Rate Adaptation mechanism.
V110	-	A standard Rate Adaptation mechanism.
PPP	RFC1661	Point to Point Protocol.
LCP	RFC1570	Link Control Protocol.
MP	RFC1990	Multi-Link (Point to Point) Protocol.
IPCP	RFC1332	Internet Protocol Control Protocol.
PAP	RFC1334	Password Authentication Protocol.
RTP/RTCP	RFC1889	Real Time and Real Time Control Protocol.
CHAP	RFC1994	Challenge Handshake Authentication Protocol.
CCP	RFC1962	Compression Control Protocol.
STAC	RFC1974	STAC LZS Compression Protocol.
MPPC	RFC2118	Microsoft Point to Point Compression (Protocol).
BACP	RFC2125	Bandwidth Allocation Control Protocol.
UDP	RFC768	User Datagram Protocol.
IP	RFC791	Internet Protocol.
TCP	RFC793	Transmission Control Protocol.
DHCP	RFC1533	Dynamic Host Control Protocol.

Protocol	RFC	Information
NAT	RFC1631	Network Address Translation.
BOOTP	RFC951	Bootstrap Protocol.
TFTP	RFC1350	Trivial File Transfer Protocol.
NTP	RFC868	Network Time Protocol.
SNMPv1	RFC1157	Simple Network Management Protocol. (STD15)
	RFC1155	Structure and identification of management information for TCP/IP based internets. (STD16)
	RFC1212	Concise MIB Definitions. (STD16)
	RFC1215	A convention for defining traps for use with SNMP.
MIB-II	RFC1213	Management Information base for network management of TCP/IP based internets: MIB-II. (STD17)
ENTITY MIB	RFC2737	Entity MIB (Version 2).
RIP	RFC1058	Routing Information Protocol.
	RFC2453	RIP Version 2. (STD56)
	RFC1722	RIP Version 2 Protocol Applicability Statement. (STD57)
IPSec	RFC2401	Security Architecture for the Internet Protocol.
	RFC2402	IP Authentication Header.
	RFC2403	The Use of HMAC-MD5-96 within ESP and AH.
	RFC2404	The Use of HMAC-SHA-1-96 within ESP and AH.
	RFC2405	The ESP DES-CBC Cipher Algorithm with Explicit IV.
	RFC2406	IP Encapsulation Security Payload. (ESP)
	RFC2407	The Internet IP Security Domain of Interpolation for ISAKMP.
	RFC2408	Internet Security Association and Key Management Protocol.
	RFC2409	The Internet Key Exchange.
	RFC2410	The NULL Encryption Algorithm and its Use with IPSec.
	RFC2411	IP Security Document Roadmap.
L2TP	RFC2661	Layer Two Tunneling Protocol "L2TP".
	RFC3193	Securing L2TP using IPSec.
Header Compression	RFC2507	IP Header Compression (IPHC).
	RFC2508	Compressing IP/UDP/RTP Headers for Low-Speed Serial Links.
	RFC2509	IP Header Compression over PPP.
DiffServ	RFC2474	Definition of the Differentiated Services Field (DS Field) in the IPv4 and IPv6 Headers.
PPP MP	RFC1990	The PPP Multilink Protocol (MP).
Frame Relay Encapsulation	RFC1490	Multi protocol Interconnect over Frame Relay.
ML-PPP	RFC2686	The Multi-Class Extension to Multi-Link PPP.

### Session Initiation Protocol

- Rec. E.164 [2] - ITU-T Recommendation E.164: The international public telecommunication numbering plan
- RFC 2833 [7] - RTP Payload for DTMF Digits, Telephony Tones and Telephony Signals
- RFC 3261 [8] - SIP: Session Initiation Protocol
- RFC 3263 [10] - Session Initiation Protocol (SIP): Locating SIP Servers
- RFC 3264 [11] - An Offer/Answer Model with Session Description Protocol (SDP)
- RFC 3323 [14] - A Privacy Mechanism for the Session Initiation Protocol (SIP)
- RFC 3489 [18] - STUN - Simple Traversal of User Datagram Protocol (UDP) Through Network Address Translators (NATs)
- RFC 3824 [24] - Using E.164 numbers with the Session Initiation Protocol (SIP)
- RFC 1889 - RTP
- RFC 1890 - RTP Audio
- RFC 4566 - SDP
- RFC 3265 - Event Notification

- RFC 3515 - SIP Refer
- RFC 3842 - Message Waiting
- RFC 3310 - Authentication
- RFC 2976 - INFO
- RFC 3323 - Privacy for SIP (PAI) and draft-ietf-sip-privacy-04 (RPID)
- RFC 3325 - Private Extensions to the Session Initiation Protocol (SIP) for Asserted Identity within Trusted Networks
- RFC 3581 - An Extension to the Session Initiation Protocol (SIP) for Symmetric Response Routing
- RFC 3311 - The Session Initiation Protocol (SIP) UPDATE Method

# Chapter 22.

# Licenses



# 22. Licenses

Many solutions, applications and features on IP Office systems are licensed and only operate when a valid license is detected. This includes features within IP Office applications running on PCs connected to the IP Office system.

Licenses are 32 character strings derived from a unique serial number for the IP Office system which will be using the license. The unique serial number is taken from the Feature Key device fitted to the IP Office system.

- **IP500 Smart Card Feature Key**

For IP500 IP Office control units, the serial number is based on the Smart Card Feature Key fitted to the control unit. A Smart Card Feature key is mandatory on all IP500 control units for correct operation of the unit regardless of whether the unit is using any licenses.

- **IP500 V2 SD Card Feature Key**

For IP500 V2 control units, the serial number is based on the System SD Card Feature Key fitted to the control unit. A System SD Card Feature key is mandatory on all IP500 V2 control units for correct operation of the unit regardless of whether the unit is using any licenses.

There are 4 types of System SD card available, which define the default operating mode:

- **System SD CARD A-Law**
- **System SD CARD Mu-Law**
- **System SD CARD PARTNER**
- **System SD CARD NORSTAR**

## Avaya IP Office Essential Edition License

In IP Office Release 7.0, no license was required to switch from Essential Edition Quick mode, Partner Mode or Norstar Mode to IP Office Essential Edition Standard Mode.

In Release 8.0, IP Office Basic Edition, Basic Edition Partner Mode and Basic Edition Norstar Mode continue to not require licenses. However, upgrading these applications to Essential Edition now requires the Essential Edition License to be applied to the system.

- The Avaya IP Office Essential Edition License material code is: **267786**

The Avaya IP Office Essential Edition License enables Mobile Twinning and one-X Mobile Essential client for all users and provides four (4) Remote Worker seats. Customers requiring more than four seats will purchase the Teleworker User package for this capability (which, in this case, requires an upgrade to Preferred Edition). As well as enabling Mobile Twinning, the Essential Edition license also enables the Mobile Call Control and Mobile Callback features without requiring a particular licensed user profile.

The Essential Edition is a pre-requisite for Preferred Edition. The Preferred Edition will not work if the Essential Edition license is not present. New customers attempting to install Preferred Edition will receive an alarm that an Essential Edition license is required.

**Note:** The Preferred Edition users will have mobile twinning enabled for all users and retain access to the Avaya one-X® Mobile Essential for IP Office client features (included with an Essential Edition license).

## Avaya IP Office Server Edition License

IP Office Server Edition supports centralized licensing. All the user specific and system specific licenses can be managed from the primary server that also acts as the centralized licensing server.

The only new license for the IP Office is the new system software license called Server Edition. The feature Key Serial Number (System ID) is derived from platform hardware.

- The Avaya IP Office Server Edition License material code is: **270397**

## Feature Keys and Licenses

For licensing, each IP Office control unit must have its own Feature Key and license. The Feature Key associated with one IP Office system cannot be used to validate the license of another IP Office system.

Since licenses are based on the serial number of the Feature Key, they cannot be moved between systems with different Feature Keys. If a Feature Key is lost the license will become invalid. If it is necessary to exchange a Feature Key due to damage or upgrade then the existing key and licenses can be exchanged (license swap) through the Avaya Direct International (ADI) website (<https://adi.avaya.com>).

Some licenses enable a number of ports, channels or users. Depending on the particular license, each supported instance may be consumed either when it is configured for use or alternatively when it is actually being used. When no further instances of a license are available, further use of the licensed feature is not allowed.



Typically for port, channel and user licenses, multiple licenses can be added to give a higher number of supported ports, channels or users. However licenses above the capacity supported by the particular IP Office control unit will not work.

The following sections detail the current individual IP Office licenses. The actual licenses are indicated by a  icon and the following information:

-  **License Name in IP Office Configuration:** *Avaya orderable part name (Material Code)*  
License description.

## IP Office Upgrade License

From Release 6 onwards IP Office needs a valid Release Entitlement to run. For new IP500 V2 systems the Release Entitlement will be free of charge delivered with the SD Card. To upgrade an older IP Office system to Release 8.0 an Upgrade license is required.

-  **Upgrading to Release 8.0 – up to 32 users:** *IPO LIC UPG R7.0 SML (267785)*  
Single control unit with no external expansion modules.
-  **Upgrading to Release 8.0 – more than 32 users:** *IPO LIC UPG R7.0 (267792)*

## IP Office Group Collaboration Licenses

### IP Office Preferred Edition





The following license is supported on all current IP Office control units.

-  **Preferred Edition:** *IPO LIC PREFRD (VM PRO) RFA LIC:DS (171991)*  
In particular, this license enables:
  - advanced messaging
  - multi-level automated attendant
  - secure meet-me conferencing
  - call recording
  - conditional call routing
  - Text to Speech (TTS) for e-mail reading for users with appropriate User profiles (for Windows only)
  - queue announcements

This system license enables Voicemail Pro and provides the initial 4 ports.

IP Office Preferred Edition Messaging (Voicemail Pro) is a messaging server application that runs on a Windows server PC. It is enabled through the Preferred Edition license (see above). Messaging services to multiple IP Offices can be supported when they are connected in an IP Office Multisite Network. In this centralized voicemail scenario, only the central IP Office requires the Preferred Edition license. The other IP Offices within the network do not require a Preferred Edition license. However, from Release 6 onwards due to load balancing, capacity increase and resilience reasons it is possible to have more than one Preferred Edition License in the Multisite Network.

By default Preferred Edition provides standard voicemail mailbox functions to all IP Office users and hunt groups plus support for call recording and call waiting announcements to callers. A range of additional features can be enabled by further licenses.

- **Additional Messaging Ports Licenses**  
The Preferred Edition license includes support for 4 messaging ports. The total number of messaging ports supported can be increased by adding combinations of the following licenses, at the time of purchase or later, up to the maximum supported by the particular IP Office control unit (IP500/IP500 V2 = 40).
  -  **Additional Messaging (2 Ports):** *IPO LIC VM PRO RFA 2 LIC:CU (174459)*
  -  **Additional Messaging (4 Ports):** *IPO LIC VM PRO RFA 4 LIC:CU (174460)*
  -  **Additional Messaging (8 Ports):** *IPO LIC VM PRO RFA 8 LIC:CU (174461)*
  -  **Additional Messaging Pro (16 Ports):** *IPO LIC VM PRO RFA 16 LIC:CU (174462)*
- **Messaging Feature Licenses**  
The Advanced Edition license provides Customer Call Reporter, ContactStore Call Recording Library, Interactive Voice Response (IVR), Visual Basic scripting and generic Text-To-Speech (for Windows only). The following licenses enable specific Messaging features beyond those already provided with Advanced Edition. These additional licenses all require the Preferred Edition (Voicemail Pro) license as a pre-requisite.
- **UMS Web Services Licenses** (also enabled by the "Office Worker," "Teleworker," and "Power User" licenses)  
UMS (Unified Messaging Server) allows users to access the messages in their Voicemail Pro mailbox via either a web browser (requires IIS on the Voicemail Pro server), using a IMAP compatible email application or using Microsoft Exchange Server 2007 message store. The total number of users supported is set by adding combinations of the following licenses. Note that a license is consumed for each user configured for UMS access.
-  **UMS Web Services - 1 User License:** *IPO LIC VM PRO UMS 1 USER (217880)*

- **Messaging Recordings Administrators License:** *IPO LIC CONTACTSTORE RFA LIC:DS (187166)*  
(also included in the "Advanced Edition" license)  
As standard, Preferred Edition supports automatic and or manual call recording to specified mailboxes. Also provided as part of Advanced Edition, this license allows Preferred Edition to use a 3<sup>rd</sup>-party application to support the storage and administration of call recordings. Currently the supported application for this is ContactStore for IP Office. When used manual and or automatic records calls can be routed (along with the call details) to the ContactStore applications database for storage and retrieval when required.

- **Text to Speech (TTS) Licenses**

TTS can be used within customized voicemail call flows to speak information to callers rather than having to record prompts for the call flow or speak results of IVR queries. Three options are supported for TTS operation:

- **Messaging TTS (ScanSoft) License:** *IPO LIC AVAYA TTS RFA 1 LIC:CU (182299)*  
This license enables the use of the TTS speech engines supplied as part of the IP Office Voicemail Pro software set. Multiple licenses can be combined for the number of simultaneous uses of TTS required up to the number of voicemail channels licensed.
- **Networked Messaging License:** *IPO LIC NTWKD MSGING RFA LIC:DS (182297)*  
Voicemail Pro Networked Messaging (VPNM) can be used between separate IP Office systems, each with their own Voicemail Pro server, to exchange messages left for different mailboxes. This option is not supported within a Small Community Network (SCN) but can be used between separate SCN networks.
- **Licensing of TTS for Linux:** *IPO LIC AVAYA TTS Pro RFA 1 LIC:CU (268844)*  
Voicemail Pro will recognize and enforce a new TTS license on Linux called "Voicemail Pro TTS Professional." The TTS Professional license behaves the same as the ScanSoft license. Voicemail Pro can provide simultaneous TTS sessions up to the number of licenses installed. That includes all Voicemail Pro features using TTS (email reading, SpeakText action and Record Prompt functionality).

Voicemail Pro on Windows will ignore the TTS Professional license and Voicemail Pro on Linux will ignore the TTS ScanSoft license. Since the generic TTS license is ignored on Linux, e-mail reading will not be available with the Preferred or Advanced Editions licenses. The Voicemail Pro TTS Professional license is required to be able to use the e-mail reading feature.

A trial version of the TTS Professional license is also available, which behaves the same as the TTS ScanSoft trial license.

As part of the Advanced Edition, the use of the default Text-To-Speech (TTS) speech engine is supplied as part of Windows operating system or any other SAPI compliant speech engine. This allows the creation of automated call flows that speak the results of IVR queries. Eight (8) licenses are provided with the Advanced Edition system license.

### IP Office Advanced Edition (Release 6 onwards)

- **Advanced Edition:** *IPO LIC R6 ADV EDITION RFA LIC:DS (229424)*  
In particular, this license enables:
  - IP Office Customer Call Reporting (CCR) including 1 supervisor
  - ContactStore Call Recording Library
  - Interactive Voice Response (IVR) with external databases
  - Visual Basic Scripting
  - 8 ports of Text-to-Speech (TTS) to allow database queries using IVR to be read over the phone (for Windows only)
  - The Advanced Edition needs a valid Preferred Edition license as a pre-requisite to run

### Essential Edition Additional Voicemail Ports License (IP500 V2 only)

Essential Edition provides embedded messaging that does not require the presence of a license. However, from Release 6.0 onwards each IP500 V2 system supports Essential Edition by default with 2 ports of voicemail enabled. This can be expanded up to 6 channels through licenses in steps of two.

- **Additional Embedded Voicemail (2 Ports):** *IPO LIC R6 ESSNTL EDITION ADD 2 (229423)*

## IP Office User Profile Licenses

The following chart shows an overview of the functions of each User Profile. For users in a Small Community Network (SCN), when they hot desk to another IP Office system, they retain their licensed profile setting as configured on their home system with the exception of Receptionist.

User Profile	Functionality Enabled								
	Mailbox	Mobility	Avaya one-X™ Portal for IP Office	IP Office Video Softphone	Unified Messaging	Text-to-Speech (Generic) for email reading (Windows only)	Soft Console	CCR Agent	CCR Supervisor
Basic User	✓								
Office Worker	✓		✓		✓				
Teleworker	✓		✓	✓	✓				
Mobile User	✓	✓				✓			
Power User	✓	✓	✓	✓	✓	✓			
<b>Add ons</b>									
Receptionist									
Customer Service Agent								✓	
Customer Service Supervisor									✓

### Basic User





This functionality would be suitable for common areas (e.g. meeting rooms) or users with less communication needs. A basic user has all basic core functions enabled. This is the default functionality for users on the system when no licenses are applied.

### Mobile Worker

This User Profile is targeted at users with mobile devices and no internet connection to the office, e.g. field sales and service staff who are often on the road. They are provided with functions such as one number access and call control as if "in the office," enabling them to never miss a call.

To get one-X Mobile Essential functionality, the systems need to be upgraded to Essential Edition. Basic Edition only supports call forwarding to the mobile device.

Mobile Workers who have Preferred Edition do not need to buy additional Essential Edition licenses. However, the IP Office Manager will give an error if the administrator tries to set a user to Mobile Worker when Preferred Edition is not present. The error will be "No Preferred License available." In systems where the users are set but there is no Preferred Edition, an alarm is sent to the administrator.



-  **Mobile Worker License - 1 User:** IPO LIC R6+ MOBILE WORKER RFA 1 (229434)
-  **Mobile Worker License - 5 Users:** IPO LIC R6+ MOBILE WORKER RFA 5 (229435)
-  **Mobile Worker License - 20 Users:** IPO LIC R6+ MOBILE WORKER RFA 20 (229436)
-  **Upgrade from Mobile Worker to Power User - 5 users:** IPO R8+ MOBILE TO PWR USER UPG 5 (267802)



### Office Worker

This User Profile is targeted at users who are working in the office. In conjunction with a wired or wireless Avaya Phone, they are provided with functions to control their communication with a PC e.g. control audio conferences or enabling them to control the voicemails with an e-mail client (this requires Preferred Edition).

Office Workers who have Preferred Edition do not need to buy additional Essential Edition licenses. However, the IP Office Manager will give an error if the administrator tries to set a user to Office Worker when Preferred Edition is not present. The error will be "No Preferred License available." In systems where the users are set but there is no Preferred Edition, an alarm is sent to the administrator.

The Office Worker license enables a user to use Unified Messaging Service (UMS) and Avaya one-X™ Portal for IP Office (without Telecommuter functionality). The license instances are consumed for each user being configured.

-  **Office Worker License - 1 User:** IPO LIC R6 OFF WORKER RFA 1 (229438)
-  **Office Worker License - 5 Users:** IPO LIC R6 OFF WORKER RFA 5 (229439)

-  **Office Worker License - 20 Users:** *IPO LIC R6 OFF WORKER RFA 20 (229440)*
-  **Upgrade from Office Worker to Power User - 5 users:** *IPO R8+ OFF WORKER TO PWR USER UPG5 (267803)*

### Teleworker



This User Profile is targeted at users who are working from home (or elsewhere) with Internet connection to the office. They are provided with the ability to leverage the PSTN/ISDN via Telecommuter mode, without incurring any remote phone charges. Alternatively the new IP Office Video Softphone can be used if the quality of service of the local internet connection is adequate. The teleworker is also capable of using a VPN phone.

Teleworkers who have Preferred Edition do not need to buy additional Essential Edition licenses. However, the IP Office Manager will give an error if the administrator tries to set a user to Teleworker when Preferred Edition is not present. The error will be "No Preferred License available." In systems where the users are set but there is no Preferred Edition, an alarm is sent to the administrator.

Teleworker includes remote worker capability with the package. An Essential Edition license provides four (4) remote worker seats. Customers requiring additional seats will need to purchase the Teleworker solution.

The Teleworker license enables a user to use Avaya one-X™ Portal for IP Office and the IP Office Video Softphone. UMS functionality for voicemail/email integration is also enabled, providing synchronization with any IMAP e-mail client (this requires Preferred Edition). The license instances are consumed for each user being configured.

Release 6 onwards

-  **Teleworker License - 1 User:** *IPO LIC R6 TELEWORKER 1 (229430)*
-  **Teleworker License - 5 Users:** *IPO LIC R6 TELEWORKER 5 (229431)*
-  **Teleworker License - 20 Users:** *IPO LIC R6 TELEWORKER 20 (229432)*





### Power User

This User Profile is targeted at key knowledge workers with the need for both Mobile Worker and Teleworker functionality. Like the teleworker, the power user is capable of using a VPN phone.

Power Users who have Preferred Edition do not need to buy additional Essential Edition licenses. However, the IP Office Manager will give an error if the administrator tries to set a user to Power User when Preferred Edition is not present. The error will read "No Preferred License available." In systems where the users are set but there is no Preferred Edition, an alarm is sent to the administrator.

The Power User license enables a user to use Avaya one-X™ Portal for IP Office, IP Office Video Softphone, all Mobility features and Unified Messaging Service (UMS). The license instances are consumed for each user being configured.

Release 6 onwards

-  **Power User License - 1 User:** *IPO LIC R6 PWR USER 1 (229426)*
-  **Power User License - 5 Users:** *IPO LIC R6 PWR USER 5 (229427)*
-  **Power User License - 20 Users:** *IPO LIC R6 PWR USER 20 (229428)*
-  **Upgrade from Office Worker to Power User - 5 users:** *IPO R8+ OFF WORKER TO PWR USER UPG5 (267803)*
-  **Upgrade from Mobile Worker to Power User - 5 users:** *IPO R8+ MOBILE TO PWR USER UPG 5 (267802)*

### Receptionist

This User profile is targeted at operators/receptionists and provides a visual PC interface for call handling and management for multiple sites. Up to 4 of these users are supported on each site.

The Receptionist license enables a user to use IP Office SoftConsole. This is a Windows PC application intended for receptionists and operators. Up to 4 SoftConsoles can be licensed on a single IP Office system.

-  **Receptionist User License:** *IPO LIC RECEPTIONIST RFA LIC:CU (171987)*  
Enables the 1<sup>st</sup> instance and subsequent instances of the PC-based operator console. Additional licenses can be added for up to 4 SoftConsoles running at any time.

### Customer Service Agent

This User Profile is targeted at employees who are responsible for fielding customer service calls. This agent license enables a user to use IP Office Customer Call Reporter. It provides them with a web browser interface to view key statistics in real-time and also allows supervisor to track their performance with IP Office Customer Call Reporter. Up to 150 agents can be licensed on IP Office Customer Call Reporter.

-  **Customer Service Agent License - 1 User:** *IPO LIC CUSTMR SVC AGT RFA 1 (217650)*
-  **Customer Service Agent License - 5 Users:** *IPO LIC CUSTMR SVC AGT RFA 5 (217651)*

-  **Customer Service Agent License - 20 Users:** *IPO LIC CUSTMR SVC AGT RFA 20 (217653)*

### Customer Service Supervisor

This User Profile enables service supervisors to track, measure and create reports for agent (or a group of agents) productivity via a web browser interface. This supervisor license enables a supervisor to use IP Office Customer Call Reporter. Up to 30 supervisors can be licensed on IP Office Customer Call Reporter.

-  **Customer Service Supervisor License - 1 User:** *IPO LIC R6 CUSTMR SVC SPV 1 (229442)*  
*Release 6 onwards*



### CCC to CCR Migration

This upgrade license will convert ALL Compact Contact Center (CCC) licenses to Customer Call Reporter (CCR). This includes all supervisors and agents.

-  **CCC to CCR Upgrade License:** *IPO LIC CUSTMR CUSTMR CALL REPORTER UPG LIC (217658)*

### Phone Manager Licenses

IP Office Phone Manager is a legacy Windows PC application that allows IP Office users to control their telephone through their PC. An optional IP Softphone is also available with additional licensing. In Release 6, it is recommended to use Avaya one-X™ Portal for IP Office and the new IP Office Video Softphone (using Teleworker or Power User licenses) instead of Phone Manager Pro.

- **Phone Manager Pro License**  
These licenses control how many users configured for Phone Manager Pro can simultaneously run Phone Manager in that mode. Multiple licenses can be combined.
  -  **Phone Manager Pro (per seat) - 1 User:** *IPO LIC PMGR PRO RFA 1 LIC:CU (177468)*
- **Phone Manager Softphone Licenses**  
These licenses control how many users configured for Phone Manager Pro PC Softphone can simultaneously run Phone Manager in that mode. Note that running Phone Manager in this mode also requires and consumes a Phone Manager Pro license for each user.
  -  **Phone Manager Softphone (per seat) - 1 User:** *IPO LIC PMGR SFTPHN RFA 1 LIC:CU (171992)*



## IP Office 500 System Licenses

The following licenses are used to enable features for systems based on the IP500 and IP500 V2 control units.



- **IP500 Universal PRI Additional Channel Licenses**

The IP500 PRI Universal trunk card (IP500 PRI-U) is available in 1 or 2 port variants, each port supporting a single PRI trunk connection. Through the IP Office configuration the ports can be switched between supporting E1, E1R2 or T1 line types as required for the trunk being connected. Each port supports 8 B-channels ("Bearer") which do not need to be licensed. If additional B-channels are required, they must be licensed through the addition of the licenses below. Multiple licenses can be added to achieve the total number of channels required. D-channels are not subject to licensing. The licenses are consumed by those channels which are configured as being 'in service', in order of the installed IP500 PRI-U cards.
- **IP500 Universal PRI Additional E1 Channels Licenses**



These licenses are used to enable additional E1 B-channels for IP500 PRI-U cards configured for E1 operation. Each port can support up to 30 B-channels in this mode.

  -  **IP500 Universal PRI Additional Channels - 2 E1 Channels License: IPO LIC IP500 E1 ADD 2CH (215183)**
  -  **IP500 Universal PRI Additional Channels - 8 E1 Channels License: IPO LIC IP500 E1 ADD 8CH (215184)**
  -  **IP500 Universal PRI Additional Channels - 22 E1 Channels License: IPO LIC IP500 E1 ADD 22CH (215185)**
- **IP500 Universal PRI Additional E1R2 Channel Licenses**

These licenses are used to enable additional E1R2 B-channels for IP500 PRI-U cards configured for E1R2 operation. Each port can support up to 30 B-channels in this mode.

  -  **IP500 Universal PRI Additional Channels - 2 E1R2 Channels License: IPO LIC IP500 E1R2 ADD 2CH (215186)**
  -  **IP500 Universal PRI Additional Channels - 8 E1R2 Channels License: IPO LIC IP500 E1R2 ADD 8CH (215187)**
  -  **IP500 Universal PRI Additional Channels - 22 E1R2 Channels License: IPO LIC IP500 E1R2 ADD 22CH (215188)**
- **IP500 Universal PRI Additional T1 Channel Licenses**

These licenses are used to enable additional T1 B-channels for IP500 PRI-U cards configured for T1 PRI or T1 robbed-bit operation. Each port can support up to 23 B-channels (T1 PRI) or 24 B-channels (T1 robbed bit) in these mode.





  -  **IP500 Universal PRI Additional Channels - 2 T1 Channels License: IPO LIC IP500 T1 ADD 2CH (215180)**
  -  **IP500 Universal PRI Additional Channels - 8 T1 Channels License: IPO LIC IP500 T1 ADD 8CH (215181)**
  -  **IP500 Universal PRI Additional Channels - 32 T1 Channels License: IPO LIC IP500 T1 ADD 22CH (215182)**
- **IP500 Voice Networking Licenses**

The use of private voice networking trunks between IP500 control units and other systems requires voice networking channel licenses within the IP500. This applies to H323 IP trunks configured on the IP500 including IP trunks being used for an IP Office Small Community Network (SCN). A voice networking license is also required for the use of trunks configured to for QSIG operation. On H323 IP trunk, a license instance is consumed for each simultaneous outgoing call (incoming calls do NOT consume a license). On QSIG trunk, the number of calls is limited by the trunk type rather than available licenses.
-  **IP500 Voice Networking (Additional Channels) License: IPO LIC IP500 VCE NTWKG ADD 4 LIC:CU (205650)**

This license enables 4 voice networking channels including the Advanced Networking features (distributed groups and hot-desking across Small Community Network). Additional licenses can be added to achieve the number of voice networking channels required.

## SIP Trunk Channel Licenses







These licenses are used to enable channels on SIP trunks added to the IP Office system. When a channel is used it requires a license. Multiple licenses can be combined for the total number of channels required. Note that SIP calls will require VCM channels during call setup and may require VCM channels during the call.

-  **SIP Trunk Channels - 1 Channel: IPO LIC SIP TRNK RFA 1 (202967)**
-  **SIP Trunk Channels - 5 Channels: IPO LIC SIP TRNK RFA 5 (202968)**
-  **SIP Trunk Channels - 10 Channels: IPO LIC SIP TRNK RFA 10 (202969)**
-  **SIP Trunk Channels - 20 Channels: IPO LIC SIP TRNK RFA 20 (202970)**







## IP Endpoint Licenses

All IP endpoints (SIP and H323, Avaya and 3<sup>rd</sup> party) require an endpoint license. There are two different types of license available:

- **Avaya IP Endpoint License** – required for all Avaya endpoints such as 1600, 5600, 9600 and DECT 3720/25.
- **3<sup>rd</sup> Party IP Endpoint License** – this is a renaming of the IP End Point License and is required for all 3<sup>rd</sup> party SIP and H.323 endpoints.
  - For each IP500 VCM32 and IP500 VCM64 card installed in the system, the 4 unlicensed VCM channels previously provided by each card are converted to allow unlicensed support of 12 Avaya IP telephones.
- **Avaya IP Endpoint Licenses**  
All Avaya IP500/IP500 V2 IP telephones (including DECT and WiFi telephones) require an Avaya IP Endpoint license and will consume one instance of that license. Note this does not apply to the IP Office Video Softphone.
  -  **Avaya IP Endpoint License - 1 Phone:** *IPO LIC R6 AV IP ENDPOINT 1 LIC:CU (229444)*
  -  **Avaya IP Endpoint License - 5 telephones:** *IPO LIC R6 AV IP ENDPOINT 5 LIC:CU (229445)*
  -  **Avaya IP Endpoint License - 20 telephones:** *IPO LIC R6 AV IP ENDPOINT 20 LIC:CU (229447)*
- **3<sup>rd</sup> Party IP Endpoint Licenses**  
Non-Avaya IP telephones (SIP or H.323 devices) require a 3<sup>rd</sup> Party IP Endpoint license to register to IP Office and will consume one instance of that license. Note that Avaya cannot guarantee operation beyond making and receiving calls.
  -  **IP Endpoint License - 1 Phone:** *IPO LIC IP40 IP ENDPOINT RFA 1 LIC:CU (174956)*
  -  **IP Endpoint License - 5 telephones:** *IPO LIC IP ENDPOINT RFA 5 LIC:CU (174957)*
  -  **IP Endpoint License - 20 telephones:** *IPO LIC IP ENDPOINT RFA 20 LIC:CU (174959)*

## Other System Licenses

-  **IPSec Tunneling License:** *IPO LIC IPSEC VPN RFA LIC:DS (182301)*  
IP Office control units can be configured to support VPN tunnels using IPSec and or L2TP. While L2TP tunnels can be configured without requiring a license, the use of IPSec tunnels requires this license. Note that IP Office VPN tunnels are not suitable terminating VPN links for Avaya VPN remote client telephones.
-  **Centralized Intuity Audix Voicemail License:** *IPO LIC ACM CENTRAL VM LIC:DS (177467)*  
Enables the use of a centralized Intuity Audix or Modular Messaging system for the IP Office voicemail server.
- **CTI TAPI Licenses**  
The IP Office TAPI software can be run in two modes; 1<sup>st</sup> party or 3<sup>rd</sup> party. 1<sup>st</sup> Party mode does not require a license and allows individual users to control their phone using a TAPI compliant application on their PC. 3<sup>rd</sup> Party mode requires licenses and allows a TAPI application to control calls for any users on the IP Office.
  -  **CTI Link Pro License:** *IPO LIC CTI RFA LIC:DS (171988)*  
This license allows the IP Office TAPI software to be run in 3<sup>rd</sup> party mode. A license is required for each server configured to run the IP Office TAPI software in 3<sup>rd</sup> party mode.
  -  **WAVE User License:** *IPO LIC TAPI WAV RFA 4 LIC:CU (177466)*  
Applications accessing the IP Office TAPI software in 3<sup>rd</sup> party mode can also be used to stream WAV files to users. This license allows streaming to up to 4 users at any time. Multiple licenses can be combined for a higher number of user up to the maximum supported by the IP Office control unit; IP406 V2 = 20, IP412 = 30, IP500 = 40.

## Trial Licenses

All new IP Offices (IP500 V2 only) will have the following trial licenses included:

- **Essential Edition:** *IPO R8+ ESSENTIAL EDITION TRIAL LIC (268842)*
- **Preferred Edition:** *IPO LIC PREFERRED (VM PRO) TRIAL RFA LIC:DS (189782)*
- **Advanced Edition:** *IPO LIC R6 ADV EDITION TRIAL LIC:DS (229425)* Release 6 onwards
- **Power User (Users):** *IPO LIC R6 PWR USER 5 TRIAL LIC:CU (229429)* Release 6 onwards
- **Customer Service Agent:** *IPO LIC CUSTMR SVC AGT RFA TRIAL 5 (227053)*
- **Customer Service Supervisor:** *IPO LIC R6 CUSTMR SVC SPV 1 TRIAL (229443)* Release 6 onwards
- **Teleworker (Users):** *IPO LIC R6 TELEWORKER 5 TRIAL:CU (229433)* Release 6 onwards

- **Mobile Worker (Users):** *IPO LIC R6 MOBILE WORKER 5 TRIAL CU (229437)* Release 6 onwards
- **Office Worker (Users):** *IPO LIC R6 OFF WORKER 5 TRIAL CU (229441)* Release 6 onwards
- **Receptionist (Users):** *IPO LIC RECEPTIONIST RFA 1 TRIAL LIC:CU (189783)*

The duration of the trial licenses will be 90 days and the trial will start from the first call made on the system. The above licenses will not preclude the installation of trial licenses obtained via ADI, once the initial licenses have expired.

## Multisite Network

In a Multisite Network (MSN), there should be at least one IP Office with Preferred Edition (two if they employ resiliency). Currently all the different types of users in multisite network have the same functionalities, independent of where the Preferred Edition is installed. The objective is to keep this behavior in the future without changing the current way MSNs are implemented.

When in a multisite network, if there is one or more Preferred Edition installed in one of the IP Offices, all the IP Offices in the multisite network will consider themselves to have a Preferred Licenses as pre-requisites for Power User, Teleworker, Mobile Worker, and Office worker. They can also organize Meet-Me conferences. To have Preferred Edition installed on an IP Office, it is still required to have a local Preferred Edition license. In case the IP Office with Preferred Edition is down, the rest will still have the same behavior as above.

Advanced Edition requires Preferred Edition as a pre-requisite. If the multisite network IP Offices consider themselves as having an Advanced Edition license, Advanced Edition can have agents and/or supervisors in different IP Offices.

If there is one or more Advanced Edition installed in one of the IP Offices, all the IP Offices in the multisite network will consider themselves to have an Advanced License as pre-requisite to Advanced Edition agents or supervisor licenses. To have Advanced Edition installed on an IP Office, it is still required to have a local Advanced Edition license. In case the IP Office with Advanced Edition is down, the rest will still have the same behavior as above.

It is acceptable that the implementation can have the following restrictions:

- The actual Preferred and Advanced Edition licenses are required to be installed on the same IP Office in a multisite network
- Avaya one-X™ Portal for IP Office server needs to be installed in the IP Office with Preferred Edition

## Upgrade Impact

Customers who already have Preferred Edition will not need to buy an Essential Edition license for their system. The Essential Edition license will be applied once the R8 upgrade license has been applied. Customers that already have Power Users or Mobile Workers but no Preferred Edition will need to buy a Preferred Edition license for their system.

For single site IP Offices with Preferred and or Advanced Edition there is no additional impact. These customers will have no upgrade issues.

For multisite network with centralized voicemail there is no upgrade issue. It is recommended that the customer upgrade (first) to the IP Offices with Preferred/Advanced edition to reduce possible loss in functionalities.

IP Offices that do not have Preferred Edition but have Office Worker, Teleworker or Power Users, will lose the functionalities associated. If they upgrade to Release 8.0 and have one of these user profiles but no Preferred Edition license they will receive a warning before the installation and relevant alarms after the installation.

The Avaya one-X™ Portal for IP Office server installation includes a note that the Power User, Teleworker, Mobile Worker and Office Worker require a Preferred Edition License, and if such license is not present Avaya one-X™ Portal for IP Office will not work.

The Avaya one-X™ Portal for IP Office server checks if there is a Preferred Edition license. If there is none present it sends an appropriate alarm to the administrator explaining that Preferred Edition license was not found.

The IP Office Video Softphone (part of Teleworker and Power User packages) checks if there is a Preferred Edition license. If there is none it sends an appropriate alarm to the administrator explaining that Preferred Edition license was not found.

## Licensing Examples

Some features require a combination of licenses.

### Example 1: IP500 Small Community Network

Each IP500	
<b>Required Licenses</b>	<ul style="list-style-type: none"> <li>IP500 Voice Networking (4 Channels).</li> </ul>
<b>Optional Licenses</b>	<ul style="list-style-type: none"> <li>IP500 Voice Networking (Additional Channels).</li> </ul>

### Example 2: Messaging in an IP500 Small Community Network

	Central IP500	Remote IP500
<b>Required Licenses</b>	<ul style="list-style-type: none"> <li>IP500 Voice Networking (4 Channels).</li> <li>Preferred Edition (Messaging 4 Ports).</li> </ul>	<ul style="list-style-type: none"> <li>IP500 Voice Networking (4 Channels).</li> </ul>
<b>Optional Licenses</b>	<ul style="list-style-type: none"> <li>IP500 Voice Networking (Additional Channels).</li> <li>Additional Messaging (ports).</li> </ul>	<ul style="list-style-type: none"> <li>IP500 Voice Networking (Additional Channels).</li> <li>Preferred Edition (Messaging 4 Ports).</li> <li>Additional Messaging (ports).</li> </ul>

### Example 3: ContactStore Recording Library in an IP500 Small Community Network

	Central IP500	Remote IP500
<b>Required Licenses</b>	<ul style="list-style-type: none"> <li>IP500 Voice Networking (4 Channels).</li> <li>Preferred Edition (Messaging 4 Ports).</li> <li>Advanced Edition or Messaging Recordings Administrator.</li> </ul>	<ul style="list-style-type: none"> <li>IP500 Voice Networking (4 Channels).</li> <li>Advanced Edition or Messaging Recordings Administrator.</li> </ul>
<b>Optional Licenses</b>	<ul style="list-style-type: none"> <li>IP500 Voice Networking (Additional Channels).</li> <li>Additional Messaging (ports).</li> </ul>	<ul style="list-style-type: none"> <li>IP500 Voice Networking (Additional Channels).</li> <li>Preferred Edition (Messaging 4 Ports).</li> <li>Additional Messaging (ports).</li> </ul>



# Chapter 23.

# Appendix

# 23. Appendix

The IP500 control unit is no longer sold by Avaya. IP500 V2 control unit is the current model available. However, the IP500 control unit is supported with IP Office Release 8.0 software.

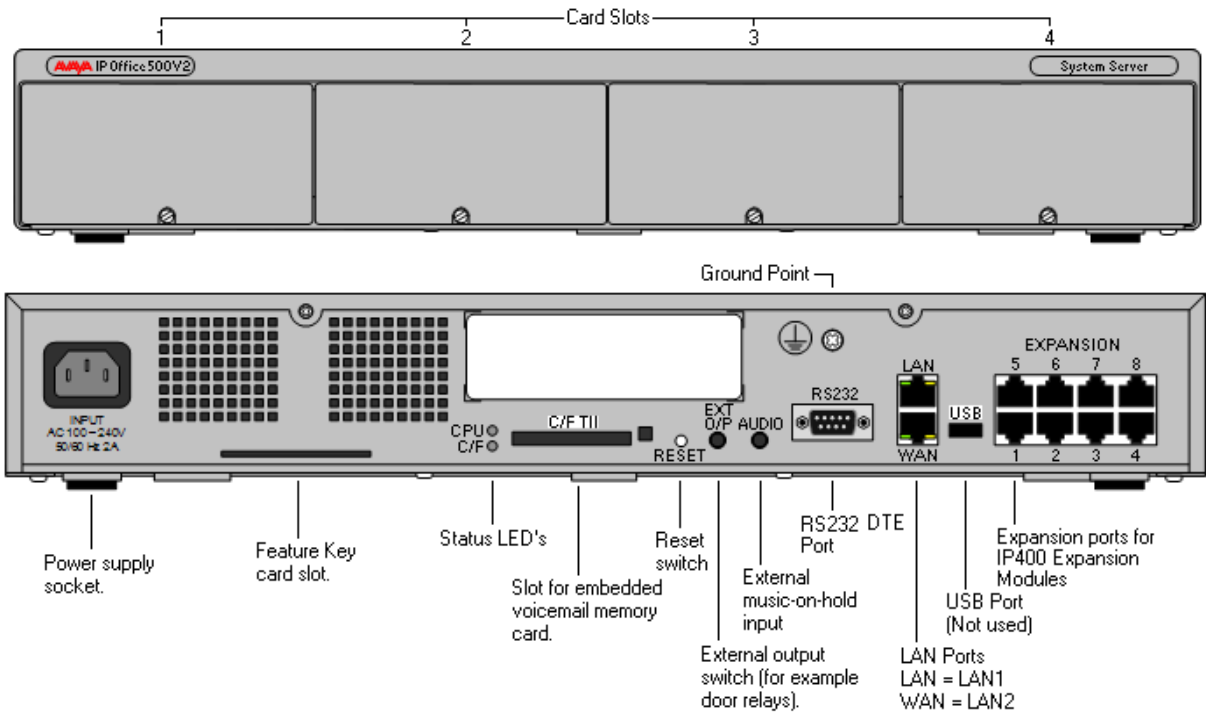

Earlier IP Office control units such as the IP406, IP406 V2, IP412 and Small Office Edition are not supported by IP Office Release 8.0.

# Index

## - A -

- Absence Text 232
  - setting 232
  - strings 232
- Absent Text Message 286
- Acceptable Delay 273
- Access Point 170
- accessing
  - Database Information within Call Flows 366
  - Email 362
- Account 12, 240, 273, 279, 298, 339, 344, 346, 361, 373
- Account Code Recording 373
- Account Codes 240, 344, 373
- ACD 250
- ACM 14, 289, 377
- ACM RFA 377
- Acquire Call 233
  - executing 250
  - waiting 250
- ACSII-CSV 414
- Active Directory 361
- ActiveX Data Objects 366
- Additional ISDN 279
- addressing
  - Domain Name Service 296
  - voicemails 378
- admin 364
- Administration 6, 107, 244, 277, 336, 361
- Administrator 12, 233, 247, 364, 366, 368, 371, 375, 414, 424
  - Change 336
- ADMM 166
- ADO 366
- Advanced Small Community 249, 286
- Advanced Small Community Networking 249, 286
- Advice Of Charge 279, 314
- Alarm Calls 378
- Alert 166, 177, 188, 190, 192, 233, 238, 239, 248, 256, 331, 357, 413
  - User 250
- ALG 281
- Algorithmic Delay 273
- All Calls 238
- All-in-one 6, 14
- allocated 296, 297, 346, 396
  - User Rights 240
- Alpha 143
- Alphabetic Keystrokes 335
- Alphanumeric 142, 175, 218, 378
- Alphanumeric Data Collection 378
- Alternate Call Routing 10
- Alternate Route Selection 233, 241, 290
- Analog 16 14, 434
- Analog 16 Module 434
- Analog Extensions 93, 221, 234, 250
- analog lines 395
- Analog Phone 14, 98, 240, 251, 254, 434, 437
- Analog Phone Ports 437
- Analog Telephone Features 217
- Analog Telephones 217, 223, 251, 256
- Analog Telephones/POTS 216
- Analog Trunk 16-port 279
- Analog Trunk Module 91
- Analog Trunk Module 16 91
- Analog Trunk Ports 437
- Analog Trunk Restriction 395
- Analog Trunks 91, 98, 241, 279, 290, 294, 395, 437
- Analog/digital 272
- ANI 279, 314, 375
- ANLG 93
- Announcements 6, 248, 249, 346, 348, 350, 378
- ANSI T1.401
  - conform 279
- ANSI T1.607 437
- Answer Interval 242
- Answered Calls 331
- Anti-Tromboning 286
- AOC 252, 279
- APAC 146, 166, 218, 223
- Appearance 221, 236, 238, 239, 335
- Appearance Buttons 238, 239
- appearance/feature 107, 194
- Applicable 98, 236, 245, 369, 373
- Application Level Gateway 281
- Applications Platform 12, 14
- Applications Platform Features 12
- ARP
  - receiving 298
- ARS 233, 241, 290
- Assisted Transfer 350, 378
- Audio 91, 142, 143, 144, 170, 234, 256, 257, 273, 275, 350, 375, 393, 394, 437
- Audio Codec 273
- Audio CODECs 275
- Audio Conferencing 393
- Audio Volume 142, 143, 144
- Audio waveform 375
- Audiotex 350
- Audit 274, 414
- AUDIX RFA 289
- August 289
- August 2003 289
- Authorization Codes 240
- Auto Connect 298
- Auto Connect Time Profile 298
- auto-attendant offers 364



- Auto-Attendant/Audiotex 378
- Auto-Create Extensions 257
- Automatic Call Distribution 250
- Automatic Callback 229
- Automatic Intercom 236
- Automatic IP 11
- Automatic Number Identification 279
- automatic/manual
  - allow 373
- automatic/manual recording
  - calls 373
- B -**
- Back When Free 252
- Backlight 173, 192, 194
- backlit 170, 221
- BACP 297, 437
- Band DTMF 257, 275
- Bandwidth Allocation Control Protocol 297, 437
- Bandwidth Required For Each 273
- Bandwidth Required For Each Voice Call 273
- bar 240, 343
  - queue panel displays 331
- Base 6, 14, 91, 93, 98, 107, 166, 177, 221, 296, 434, 437
- Base Unit 177, 221, 296, 434
- Base Unit Power Supply Adapter 177
- BaseT Ethernet 142, 143, 144, 188, 190, 192
- Basic Commands 378
- Basic Rate 279, 296
- B-channel 64kbps 437
- Bellcore Special Report SR4287 437
- Belt Clip 168, 169, 170, 177
- bi-directional 254
- BLF 286, 335, 336, 372
  - form 244
  - groups 331
- BLF Groups 335
- BLF Panel 331, 336
- Blind Transfer 230
- BlindTransfer 342
- Book Shop 367
- BOOTP 437
- Bootstrap Protocol 437
- Bothway 298
- bps 273
- branch maximizes 277
- branches 6, 254, 277
  - DEFINITY/ACM 289
- Branch-to-Branch 11
- Brazilian 350, 367
- Break Out 252, 372
  - set 234
- Break Out Dialing 234
- Breakout 286, 348
  - Reception 378
- Breakout Dialing 286
- BRI 91, 98, 102, 238, 277, 279, 437
- BRI ISDN 277
- BRI S-interfaces
  - ISDN 102
- BRI So8 91
- BRI-4 91
- BRI-8 91, 93
- Bridged Appearance 236, 238, 239
- bridged appearance button matches 239
- Bridged Appearance Buttons 238, 239
- Built-in IP 284
- business needs 240
- business-to-business 293
- Busy
  - DND 331
- Busy Lamp Field 244, 286, 314, 331
- Busy Lamp Field Panel 331
- Busy On Held 252
- Busy Subscriber
  - Call Completion 279
- Busy/Engaged 369
- buy/lease 6
- bypass
  - DND 233
- Bytes 273
- C -**
- C3000 361
- Cable 91, 93, 98, 103, 124, 223, 434
- Cable Lengths 434
- CALA 223
- Call 142, 242, 248, 291, 293, 298, 339, 375, 413
  - Advice of charge during 279
- Call Appearance 236, 238, 239
- Call Appearance button 236, 238, 239
- Call Appearance/Feature 107, 194
- call arrives 331
- Call Back Sender 378
- Call Back When Free 229, 230, 286
- Call Barring 240
- call billing 339
- Call Center 12, 250, 271, 339, 361, 370
- Call Completion
  - Busy Subscriber 279
- call costing 240
- Call Coverage 233, 238, 239
- Call Coverage Buttons 238, 239
- Call Detail Records 413
- Call Details 413, 424
- Call Details Panel 331
- Call Duration 331
- call flow programming interface 368
- Call Flow Utilizing Database Actions 366
- Call Flows 365, 366, 367, 368, 394
- Call Forwarding 10, 18, 227, 242, 365

- Call Handling 6, 12, 18, 227, 232, 314, 331
- Call History 244, 314, 331, 336
- Call Hold 285, 289
- Call Identifier 344
- Call Intrude 234, 252
- Call List 252
- Call Listen 252, 350
- Call Log 107, 142, 143, 144, 190, 192, 228, 234, 240, 314
- Call Pickup 235, 252
- Call Pick-up 169, 286
- Call Pickup Any 252
- Call Pickup Extension 250
- Call Pickup Extn 252
- Call Pickup Group 252
- Call Pickup Line 252
- Call Pickup Members 252
- Call Pickup User 252
- Called/Calling Line ID Presentation 278
- Called/Calling Name 278, 285
- Called/Calling Name Presentation 278
- Called/Calling Number 285
- Caller Display 216
- Campaign Manager 12, 350, 372, 378
- Can Intrude 234, 343
- Cancel All Forwarding 252
- Cancel Ring Back When Free 252
- Captaris 361
- Cascaded Out-calling 371
- Castelle 361
- Castelle Fax 361
- Castilian 350
- CAT 124
- CAT5 124, 434
- Catalyst 124
- CCBS 279
- CCC 91, 234, 249, 286, 350
- CCP 437
- CD 375
- CD-Rom 339
- CDRs 240
- CE/UL/Dentori Safety Approved 434
- cell/mobile 364
- Central Office 98, 279, 293, 294
- Centralized 14, 18, 227, 277, 284, 286, 289, 346, 350, 377, 378
- Centralized INTUITY Audix 346
- Centralized Messaging 377
- Centralized VM 377
- Centralized Voice Mail 286
- Centralized voicemail 14, 277, 289, 350, 378
- Centralized Voicemail Services 378
- Challenge Handshake Authentication Protocol 297, 437
- Channel Associated Signaling 279
- Channel Monitor 252
- CHAP 294, 297, 298, 299, 437
- Charger Unit 177
- checkbox 362
- Checking 279
- Circuit Switched 278
- Circuit Switched Data Call/Basic 289
- Circuit Switched Data Call/Basic Call 278, 289
- Circuit Switched Voice Networking 278
- Circuit-switched 254
- Cisco 124, 271
- Cisco Systems 124
- C-LAN
  - DEFINITY 9.5 289
- Clear Call 252
- Clear CW 252
- Clear Hunt Group Night Service 252
- Clear Hunt Group Out
  - Service 252
- Clear Hunt Group Out Of Service 252
- Clear Quota 252
- CLI 218, 314, 342, 437
- CLI Feature 218
- CLI Schemes 437
- CLI/ANI 350
- CLIP 279
- CLIR 279
- Clock 296
  - Speaking 350, 378
- closet/switch
  - wiring 124
- Code Used 240
- Codec G.711 166
- Codecs 142, 143, 144, 188, 190, 192, 272, 289
- Cold Start 414
- Color Backlight Display 192
- COLP
  - Inhibits 279
- COLR 279
- Comfort 107, 170, 222
- comma-separated 339
- Common Features 142, 143, 144, 188, 190, 192, 194
- Compact Business Center 12, 14
- Compact Contact Center 12, 350
- Compact Mode 314
- companies' LANs 254
- company's
  - IP Telephony unites 254
- compared 166
  - Service Provider conferencing 393
- Compressing
  - IP/UDP/RTP Headers 437
- Compression Control Protocol 437
- Computer Telephony Integration 91, 339

- Concise MIB Definitions 437
- Concurrent Calls
  - Maximum Number 378
- Conference Add 252
- Conference Bridge 6, 249, 394, 395, 396
- Conference Calling 10, 251
- Conference Control Display 314
- Conference entry/exit 396
- Conference Held Calls 331
- Conference Meet Me 252
- Conference Resources 395
- Conference Room 223, 331, 335
- conferencing 10, 91, 177, 188, 190, 192, 228, 244, 331, 335, 393, 394, 395, 424
  - benefits relating 396
  - Eliminating 6
  - manage 396
  - relating 396
- Conferencing Center 14, 91, 251, 314, 331, 395
- conferencing service 6
- Conferencing tone 228
- Conferencing tone depending 228
- congestion-control 274
- Connected Line Identification Restriction 279
- connection-oriented 284
- Contact Center 12, 91, 107, 222, 250, 366, 372
- Contact Center Features 250
- Contact Management 12
- Contact-ability 365
- contactable 146
- ContactStore 14, 91, 350, 373, 375
- ContactStore Search 350
- Continuous Loop Greeting 378
- Control Unit Conference Capabilities 395
- controlled according 375
- controlling calls 241
- copier/scanner 361
- CoS 274
- CPE 296
- CPU 375
- CPU loading 375
- CRC 279
- Create' 370
- CreateCall 342
- CRM 361
- CS-ACELP 275
- CSU 98, 279, 423
- CSU Loop-Back 423
- CSU/DSU 98, 279
- CTI 12, 91, 232, 339, 340, 396
- CTI interoperability
  - levels 339
- CTI Link Lite 339
- CTI Link Pro 91, 339
- CTI Link Pro RFA 339
- CTI middleware 339
- CTR3
  - ETSI T-Bus Interface 437
- CTR4
  - ETSI T-Bus Interface 437
- cust 232
- Customer Contact 398
- Customer Contact Center 398
- Customized Voicemail 378
- CW 252
- CW1308 434
- Cyclic Redundancy 279
- D -**
- D Message 344
- Data Access Components 366
- Data Call 248, 249, 278, 297
- Data Communication Solution 11
- Data Communication Solution Features 11
- Data Compression 297
- Data Header Compression 297
- Data Jack 217
- Data Rates 437
- data traffic 170, 273, 284, 296
- Database 228, 350, 361, 366, 367, 372, 373, 375
- Datagram Protocol 437
- Day One
  - starting 6
- Day/Night service 221
- D-channel 16kbps 437
- D-channel 64kbps 437
- DDI 230, 279, 342
- DDI/DID 18, 166, 227, 248, 279, 364
- DDI/DID call 248
- DECT 146, 166, 279
- DECT Networking 166
- Default
  - E&M 437
- default greeting 231
- default numbering 233
- Definable PIN Code 378
- DEFINITY 107, 289
- DEFINITY 6400 107
- DEFINITY 9.5
  - C-LAN 289
- DEFINITY G3si 289
- DEFINITY/ACM
  - branches 289
- DEFINITY/ACM occupying 289
- Delete Message 378
- deleting 231
- Delphi 342
- Deploying
  - IP 124
- Depth 168, 434
- Designing

- Designing
  - IP Telephony 256
- Desk/Wall Mount 217
- deskiers 234
- desking 234
- DevConnect 340
- Developer Connection Program 340
- DeveloperConnect 340
- Developers 339, 340, 343, 344
- DevLink 339, 344
- DevLink Lite 339
- DevLink Pro 339
- DevLink Reserved Fields 344
- DHCP 11, 173, 175, 274, 296, 298, 396, 437
- DHCP Server 296, 298, 396
- Dial 3K1 252
- Dial 56K 252
- Dial 64K 252
- Dial calls 236, 240
- Dial CW 252
- Dial Direct 252
- Dial Direct Hot Line 252
- Dial Emergency 240, 252
- Dial Extn 252
- Dial Inclusion 252
- Dial On Pickup 251
- Dial Pad 331, 335
- Dial Paging 252
- Dial Plan 233
- Dial Speech 252
- Dial V110 252
- Dial V120 252
- Dial Video 252
- Dialed Number 228, 230, 241, 279, 375
  - controlling 244
- Dialed Number Identification String 279
- dial-in/dial-out to/from 294
- Dialing In 279, 294, 298
- dialing plan 233, 277
- DialPhysicalExtensionByNumber 252
- DialPhysicalNumberByID 252
- Dial-Up Circuit Support 296
- DID 230, 279
- DID/DDI 279
- Differentiated Services Field 437
- Diffserve 284
- Digital Station Expansion Module 103
- Digital Telephones 14, 177
- Digital Wireless 3810 Telephone 177
- Digital Wireless North American 146
- Dimensions 168, 434
- Direct Dialing 18, 227, 236, 364
- Direct Dialing In 279
- Direct Inward Dialing 230
- Direct Media 142, 257, 272, 350
- Direct Media Path 257
- Direct Sequence Spread Spectrum 175
- Direct Station Select 103, 244
- Directory 6, 11, 218, 228, 244, 277, 298, 331, 335, 343
- Directory Entry 331
- Directory Panel 331
- Directory.csv 414
- Disable ARS Form 252
- Disable Internal Forward Busy 252
- Disable Internal Forward Unconditional 252
- Disable Internal Forwards 252
- discover
  - NAT 281
- Disk Space 375
- Display Backlight 192
- Display Msg 252
- Distinctive 230, 314
- Distinctive Ringing 230, 314
- distinguish
  - doorphone 221
- distribute 249, 286, 339, 361
  - voicemail 370
- Distributed Hunt Groups 249, 286
- Disturb 232, 340
- DMS100 279
- DMS-100 437
- DMS-250 437
- DMZ 281
- DND 233, 242
  - bypass 233
- DNIS 279, 375
- DNS 296, 297
- Do Not Disturb 232, 233, 236, 242, 244, 252, 340, 343
- Do Not Disturb Exception Add 252
- Do Not Disturb Exception Delete 252
- Do Not Disturb Off 252
- Do Not Disturb On 252
- Domain 296, 297
- Domain Name Service 296, 297
- Door Entry 91, 221, 235, 251, 335
- doorphone
  - distinguish 221
- doorphone calls 221
- Doorphone Entry 221
- Doorphones 221
- DS 14, 93, 103, 107, 142, 143, 144, 177, 188, 190, 192, 434, 437
- DS 16 Module 434
- DS 30 Module 434
- DS Field 437
- DS Phones 188, 190, 192
- DSS 103, 142, 143, 144, 223, 244, 372
- DSS key 372

- DSS key incorporates 372
- DSS Modules 142, 143, 144
- DSS Unit 223
- DSS/BLF 229
- DSS/BLF key 229
- DSSS 175
- DSU 98, 279
- DTE 437
- DTE Port 437
- DTMF 217, 221, 241, 257, 275, 279, 290, 340, 364, 366, 372, 437
  - sending 314
- DTMF Dialing 217
- DTMF Digits
  - RTP Payload 437
- DTMFA 437
- DTMFC 437
- DTMFD 437
- D-Type 437
- D-type on IP412 437
- Dual Charger 170
- Dual PRI E1 93
- Dual PRI E1R2 RJ45 93
- Dual PRI T1 93
- Dual Universal PRI 91
- Dutch 168, 169, 350, 367
- DVD 375
- Dynamic 11, 142, 143, 144, 188, 190, 192, 284, 437
- Dynamic Host Control Protocol 437
- Dynamic IP 142, 143, 144, 188, 190, 192
- E -**
- E&M DID 279
- E&M Switched 56K 279
- E&M Tie Line 279
- E.164 437
- e.g 241, 290
- E1 14, 98, 238, 278, 279, 289, 377, 395
  - including 10
- E1 ISDN 395
- E1 PRI 238
- E1/T1 289, 296
- E1R2 98, 238, 279
- E1R2 Channel Associated Signaling 279
- E1R2 MFC 98
- E911 251
- Echo 272
  - 128ms 10
- e-commerce
  - Internet 293
- ECT 279
- eg 232
- Eliminating
  - conferencing 6
- ELR/TBR switchable 218
- Email 6, 91, 170, 231, 293, 294, 298, 346, 350, 423
  - accessing 362
  - Copy 378
  - Forward 378
  - leading 361
  - reading 12
  - sends 375
  - subject 357
  - Voicemail 357
- Email addresses 362, 375
- Email application 357
- email inboxes 12
- Email Notification 357, 423
- Email Reading 362
- email reading checkbox 362
- Email Systems 12, 357
- emails 350, 357, 362
- e-mails 284
- Embedded 14
- Embedded Applications 142, 143, 144, 188, 190, 192
- Embedded Messaging 14, 231
- Embedded Messaging Card 423
- Embedded Voice Memory 437
- Embedded Voicemail 12, 14, 91, 249, 252, 272, 346, 348, 378, 423
- Enable ARS Form 252
- Enable Internal Forward Busy 252
- Enable Internal Forward Unconditional 252
- Enable Internal Forwards 252
- enabled/disabled 233
- Encapsulation 296
  - Frame Relay 275
- encoding
  - G711 173, 175
- Enlarged earpiece 174
- Enterprise 170, 271, 361, 393
- ENTITY MIB 437
- entry/double 396
- Entry-level voicemail 348
- EnumerateAddresses 342
- Equisys 361
- ERP 361
- escalates
  - doctor's mobile/cell 371
- ESP 437
- ESP DES-CBC Cipher Algorithm 437
- Estimated Time
  - Answer 378
- ETA 378
- Ethernet 11, 14, 91, 102, 124, 142, 143, 144, 166, 170, 188, 190, 192, 194, 254, 281, 293, 295
- Ethernet eliminates 124
- Ethernet LAN 170, 254

- Ethernet Ports 14, 142, 143, 144, 188, 190, 192, 281, 293
- Ethernet Switch 11, 293, 295
- EU24 103, 192, 194
- Euro ISDN 98
- Except 142, 243, 281, 284, 395, 423
  - 4601 124
- Exchange/SMTP
  - GFI FAXmaker 361
- executing
  - Acquire Call 250
- Executive Wireless 223
- Exit Queue 378
- Expansion 14, 91, 93, 102, 103, 105, 188, 190, 192, 194, 279, 423, 424, 434
- expansion module provides 105
- Expansion Modules 14, 91, 103, 105, 192, 423, 434
- Expansion Units 434
- Explicit Call Transfer 279
- Explicit IV 437
- Exporting 414
- Extended Callback Control Protocol 297
- Extended CBCP 297
- Extended Personal 350, 369, 378
- Extended Personal Greetings 350, 369
- EXTENSION NUMBER 414
- External 102
- External Bell 437
- External Call 230, 234
- External Expansion Modules 102
- External Number 242, 249, 279, 348
- External O/P 91
- External Participants 395
- External Systems
  - Forward Emails 378
- Extn Login 252
- Extn Logout 252
- Extreme Alpine Series 257
- Extreme Alpine Series switches 257
- Extreme Networks 257
- F -**
- failover 102
- Fall Back 248, 293
- Fast Forward 231, 348, 378
- Fast Forward Message 378
- Fast Start 257
- Fax 14, 257, 275, 289, 348, 361, 362, 378
  - routing 350
- fax calls 257
- Fax Messages 361, 362
- Fax Relay 275
- Fax Transport 257
- Faxination 361
- FaxMail Pro 361
- FCC 173, 175, 437
- Feature Key 14, 91, 166, 188
- Feature Licensing 14
- FEATURE NAME 414
- Feature Support 378
- Feature Table 217
- Fenestrae 361
- Fenestrae Faxination Server
  - Microsoft Exchange 361
- Field Data 344
- File Transfer Protocol
  - including 298
- Finnish 168, 169, 350
- firewall 11, 91, 284, 293, 294, 298, 396
  - Small Office Edition offers 295
- firewall/VPN 6
- firewalled 293
- firewalled Layer 293
- firewalls 298
- Firstly
  - TTS 362
- Fixed Feature Buttons 142, 143, 144, 188, 190, 192
- Flash Hook 252
- Flash Memory 348
- Flow Control 142, 143, 144, 188, 190, 192, 274
- Follow Me 236, 242, 243, 252, 343, 350, 365
- Follow Me Here 252
- Force login 343
- Forced Account Code
  - set 240
- Forward All 244, 340
- Forward All Calls 340
- Forward Busy 242
- Forward Emails
  - External Systems 378
- Forward Hunt Group 243, 252, 343
- Forward Hunt Group Calls Off 252
- Forward Hunt Group Calls On 252
- Forward Message 378
- Forward No Answer 242, 250
- Forward Number 252, 343
- Forward on Busy 238, 242, 243, 252, 340, 343
- Forward On Busy Number 252, 343
- Forward On Busy Off 252
- Forward On Busy On 252
- Forward on No Answer 232, 242, 252, 340, 343
- Forward On No Answer Off 252
- Forward On No Answer On 252
- Forward Unconditional 242, 243, 252, 343
- Forward Unconditional Off 252
- Forward Unconditional On 252
- Forward voicemails 289
- Forwarding 243, 331
  - Email 378

- Forwarding 243, 331
  - Multiple 378
  - Multiple Mailboxes 378
  - voicemail 350, 357
- Forwarding except 243
- FRAD 284
- frame instructs 274
- Frame Relay 272, 293, 294, 296, 350, 437
  - Encapsulation 275
  - framed 284
- Frame Relay Assembler Disassembler
  - IP Office employs 284
- Frame Relay Encapsulation 437
- Frame Relay's PVCs 284
- framed 272, 274, 275, 293, 294, 296, 350, 437
  - Frame Relay 284
- Front Door 221
- FSK 437
- FTP 298
- G -**
- G.711 142, 143, 144, 188, 190, 192, 273, 275
  - including 257
- G.711 A-law/U-law 275
- G.711A 289
- G.711MU 289
- G.723 166
- G.723.1 273, 275
- G.723.1 MP-MLQ 275
- G.723.1. 257
- G.723.1-6K3 289
- G.726 16kbps ADPCM 375
- G.729 166, 275
- G.729 Annex 275
- G.729a 173, 257, 273, 289
- G.729a/b 142, 143, 144, 188, 190, 192
- G711
  - encoding 173, 175
- Gatekeepers 254, 257
  - requests 256
- Gateway 10, 170, 254, 256, 257, 271, 272, 284, 293, 294
- Greetings 348, 350, 369, 378
- Greetings & Mailbox Navigation 348
- greetings provide 369
- Ground Start 10, 102, 105, 279, 437
- Ground-Start 279
- GROUP 414
- Group Listen 252
- Group Listen Off 252
- Group Listen On 252
- Group working 166
- H -**
- Handover 166
- Hands Free Pouch 170
- Handset 18, 91, 142, 143, 144, 166, 168, 169, 170, 177, 217, 227, 231, 235, 247, 248, 284, 296, 297, 339, 350, 371
- Handset Liquid Crystal Display 177
- handset offers
  - high-resolution 170
- Handset Volume Control 177, 217
- Hands-free/ Speakerphone 169
- Hardware 91, 166, 337
- Hardware provides 91
- Head Office 14
- Header Compression 275, 437
- Header Message 378
- Headset 142, 143, 144, 168, 169, 170, 177, 188, 190, 192, 218, 222, 251, 252
- Headset Socket 142, 143, 144, 188, 190, 192
- Headset Toggle 252
- headset/microphone 254
- Heat Dissipation 434
- Held Calls Panel 331
- Held Panel 331
- Help Desks/Support Desks 366
- HH 414
- High Voltage 218
- Hold 6, 177, 188, 190, 192, 217, 229, 230, 233, 234, 244, 252, 293, 296, 331, 342, 369, 378
- Hold Call 229, 252, 331
- Hold Call Waiting 229
- Hold CW 252
- Hold Music 229, 252
- Hook 247, 251
- Hook Dialing 247
- Hot Desk 234, 286
- Hot Desking 234
- Hours greeting 249
- HP's Network Node Manager 423
- HTTP 298
- Hunt Group Broadcast Messages 370
- hunt group call handling 243
- Hunt Group call ringing 235
- Hunt Group Calls 235, 236, 243, 248, 249
- Hunt Group Disable 252
- Hunt Group Enable 252
- Hunt Group Enable/Disable 233
- Hunt Group exceed 250
- HUNT GROUP EXTENSION 414
- HUNT GROUP NAME 414
- Hunt Group Recording 373
- HuntGroup.csv 414
- Hybrid™ PBX 254
- Hz 124
- I -**
- I55 289
- ICLID 279
- Illuminated 3-line 168

- Illuminated 5-line 169
- IM 314
- Immediate Reboot 414
- Inbound Call Handling 248
- Incoming Call 232, 248, 279, 297, 314, 331, 346, 350, 373
- Incoming Call Routes 232, 248, 346, 350, 373
- incoming call scripting 314
- indicating
  - Talk 177
- industry-standard 289
- Information Bulletin Boards 366
- Information Protocol
  - Routing 298, 437
- Information within Call Flows 366
- Inhibits
  - COLP 279
- Inline Power 10/100 BaseT Switching Module 124
- input rating
  - power 434
- In-Queue Announcements 378
- Insert 228, 366, 375
- Installation Guide 177
- Integral 10/100 Mbit Layer 295
- Integral Static 11
- Integral T3 107
- Integral T3 IP 107
- Integrated H.323 Gatekeeper 10
- Integrated Management Suite 423
- Integrated Messaging 12, 378
- Integrated Messaging Pro 12, 14
- Intelligent 6, 248
- Interaction 6, 366, 372
  - Voicemail 357
- Interactive Voice Response 6, 12, 91, 366
  - building 350
- Interchange 289
- Internal Call 230, 236, 344
- Internal Directory 286
- Internal Modem 13, 14
- Internal Modem Card 13, 14
- Internal Twinning 236
- Internal/External 369
- Internal/External greeting 369
- Internet Access 11, 293, 296, 297
- Internet browsing 298
- Internet Explorer 375
- Internet IP Security Domain
  - Interpolation 437
- Internet Key Exchange 437
- Internet Protocol 254
  - Security Architecture 437
- Internet Protocol Control Protocol 437
- Internet Protocol refers
  - type 254
- Internet Security Association 437
- Internet Service Provider 298
- Internet Standards/Specification 275
- Internet Telephony 6, 10, 281
- Internet Telephony Service Providers 281
  - SIP trunking 10
- internets 437
- Internetworking 289
- interoperability 285, 340
  - messaging 289
- Interoperable 289
- interoperate 298
  - networking 10
- interoperation 298
- Interpolation
  - Internet IP Security Domain 437
- Interquartz 218, 221, 223
- Interquartz Doorphone 221
- Interquartz Gemini 218, 223
- Interquartz Gemini 9281-AV 223
- Interquartz Gemini Phones 218
- Introduction 107, 413
  - IP Telephony 254
- Intrude 234, 250, 339, 343, 350
- INTUITY 289, 314, 350, 361, 362, 363, 369, 370, 371, 377, 378
- Intuity Audix 289, 378
- Intuity Audix 4.4 289
- Intuity Audix Emulation Features 378
- Intuity AUDIX™ 289
- Intuity Emulation 346
- Intuity Feature 378
- INTUITY Mode 361, 362, 363, 371
- Intuity TUI 378
- Invited 331
- IP Address Assignment 142, 143, 144, 188, 190, 192
- IP Authentication Header 437
- IP DECT 3700 336
- IP DECT Capacities 166
- IP DECT IPO STARTER KIT 166
- IP DECT System 166
- IP DECT Telephone 166, 168, 169
- IP DECT Wireless Handset 223
- IP Encapsulation Security Payload 437
- IP Extensions 14, 257
- IP Hard Phone 254
- IP Office Management Utilities 413
- IP Office Manager 13, 91, 230, 233, 234, 238, 244, 279, 298, 362, 369, 370, 373, 396, 414, 424
- IP Office Phone Manager application maintains 244
- IP Office Phone Manager Lite 396
- IP Office Professional Edition 91, 350, 378, 395
- IP Office Professional Edition Upgrade 91



- IP Office Small Community Networking 229, 230, 232, 234, 235, 244, 285
  - IP Office Standard Edition 91, 395
  - IP Office stores
    - list 240
  - IP Office Supports 298
  - IP Office Time Profiles 373
  - IP Office Voicemail Pro Intuity Audix Emulation Features 378
  - IP Office VoIP 274
  - IP Office's 281
  - IP Office's Directory 228
  - IP Office's list 240
  - IP Offices Transit Network Selection 279
  - IP Office's WAN 284
  - IP Packet 274, 284
  - IP Packet Flow Control 274
  - IP PBX 254
  - IP Phone Adapter 124
  - IP Phone Power Adapter 124
  - IP Phones 91, 124, 188, 190, 192, 245, 250, 256
  - IP Power 124
  - IP Security Document Roadmap 437
  - IP Service 293
  - IP Telephone Power Consumption 124
  - IP400 3rd PRTY IVR RFA 366
  - IP400 Analog 16 14
  - IP400 Analog Trunk 16 14, 105
  - IP400 Analog Trunk 16 Module 105
  - IP400 Digital Station 103
  - IP400 Digital Station V2 Module 103
  - IP400 Phone 230
  - IP412 11, 14, 91, 102, 251, 257, 274, 293, 295, 296, 346, 378, 395, 434, 437
  - IP412 Control Units 434
  - IP412 Maximum Heat Dissipation 434
  - IP412 Supports Two 64-party Conference Banks 395
  - IP500 11, 12, 14, 91, 93, 102, 103, 105, 251, 257, 274, 279, 286, 293, 295, 346, 350, 378, 395, 434, 437
    - default 91
    - existing 98
    - voicemail 348
  - IP500 Analog Phone 98
  - IP500 Analog Trunk 16 102, 105
  - IP500 Analog Trunk 16 Expansion Module 102
  - IP500 Analog Trunk 16 Module 105
  - IP500 Analog Trunk Card 98
  - IP500 BRI 98, 102, 279
  - IP500 BRI So8 102
  - IP500 BRI So8 Expansion Module 102
  - IP500 BRI Trunk Card 98
  - IP500 Cards 93
  - IP500 Compact Flash voicemail 12
  - IP500 Control Unit 91, 93
  - IP500 Digital Station 98, 102, 103
  - IP500 Digital Station Expansion Module 102
  - IP500 Digital Station Module 103
  - IP500 Expansion Modules 91
  - IP500 Legacy Card Carriers 93, 98
  - IP500 Phone 102
  - IP500 Phone Expansion Module 102
  - IP500 PRI 98
  - IP-based WiFi 146
  - IPCP 437
  - IP-DECT 166
  - IPSec 11, 284, 299, 437
  - IPSec Tunneling 299
  - IPSec VPN 284
  - IP-telephony 124
  - ISAKMP 437
  - ISBN
    - asked 367
    - enters 367
  - ISDN 10, 98, 248, 272, 275, 278, 293, 294, 296, 314, 437
    - BRI S-interfaces 102
    - following 279
    - incoming 279
    - outgoing 279
  - ISDN Basic 279
  - ISDN Basic Rate 279
  - ISDN DSS1 279
  - ISDN MSN 248
  - ISDN Ports 437
  - ISDN Primary 279
  - ISDN Primary Rate 279
  - ISDN/PRI 248
  - ITAddress 342
  - ITU-T Recommendation E.164 437
  - IVR 6, 12, 350, 366, 378
    - providing 368
- J -**
- Japanese 350, 367
  - Juniper 271
- K -**
- Kbps 286
  - Kentrox 271
  - Key Management Protocol 437
  - Key System 254
  - Keyboard Actions 335
  - Keyboard Mapping 335
- L -**
- L2TP
    - Securing 437
  - Lamp Operation 238
  - Language 168, 169, 232, 245, 340, 346, 348, 350, 362, 364, 367, 414
  - language depending 346

- Lanyard 170, 173  
 Last Number Redial 218, 252  
 Latin 350, 367  
 Latin American 350  
 launch 424  
 Layer Two 437  
 Layer Two Tunneling Protocol 437  
 LCD 177, 218, 231  
 LCP 297, 437  
 LCR 290  
   Existing 241  
 LCS 314  
 LDAP 11, 298  
 leading  
   email 361  
 Leased Line 11, 278, 293, 296  
   types 296  
 Leased Line Support 296  
 Least Cost 240, 241, 249, 277  
   Existing 290  
 Least Cost Routes 240, 249  
 Least Cost Routing 241  
   Existing 290  
 LED 124, 142, 143, 144, 218  
 Legacy Card Carrier 91, 98  
 License Key 14, 299, 339, 348, 362, 366  
 License.csv 414  
 LIFO/FIFO 378  
 Link Control Protocol 297, 437  
 Linked Numbering 291  
 Linked Numbering Scheme 291  
 Lite 12  
 Lithium Ion Battery 173  
 LLB 98, 279  
 Local Area Network 254, 257, 293, 296, 298, 340  
 Local End Echo Cancellation 25ms 275  
 Local Phone Directory 314  
 Local Telcos 279  
 Locating  
   SIP Servers 437  
 Longest Waiting 248, 335  
 Loop Greeting 378  
 Loop Start 10, 102, 105, 279  
 Loop start/Ground 437  
 Loop-Start 98, 279  
 Lord Of The Rings 367  
 Lotus Notes 357, 361  
 Low-Speed Serial Links 437
- M -**
- Mail Box  
   Remote Access 378  
 Maintainers Network Manager 423  
 make/receive  
   headset/microphone 254  
 Malicious Call Identification 279  
 Manage voicemail 377  
 Managed Frame Relay Network 284  
 Managed IP VPN 272, 284  
 Management Tools 13  
 Manager 5.1 414  
 Manager application 234  
 Manager provides 414  
 manager/secretary 239  
 Management Information 437  
 Many Avaya 230, 238, 244  
 Many Simultaneous Calls Can 273  
 MAPI 12, 357  
 Mbps 274, 284  
 Mbps LAN 284  
 MCID 252, 279  
 MCID Activate 252  
 MCU 256  
 MDAC 366  
 Media 14, 256, 272, 275, 335, 339, 362, 423  
 Media Service Provider 339  
 Medical 6  
 medical issues 6  
 Medium-Size Companies 6  
 Meet Me conferencing 393  
 Meeting 232  
 Meet-Me 91, 394, 395  
 Meet-Me conferencing 91  
 Meet-Me Conferencing on IP500 395  
 Meet-Me Conferencing Solution 394  
 Memory 177, 218, 229, 272, 437  
 Menu Bar 331  
 MERLIN MAGIX 107  
 Message Announcements 378  
 message handling  
   individuals 350  
 Message light 217  
 Message Storage Capacity 346  
 Message Waiting 14, 142, 143, 144, 177, 218,  
 230, 278, 370, 377  
 Message Waiting Indication 218, 230, 289, 378  
 Message Waiting Indicator 188, 190, 192  
 message waiting lamps 230  
 Message Waiting Light 217, 289  
 Messages Button 190, 192  
 Messaging Card 14, 423  
 Microsoft application 297  
 Microsoft Live 314  
 Mid Span Power 124  
 Mid-Span 124  
 Mid-Span Power Distribution Units 124  
 Miercom 6  
 milli-seconds 273  
 ML-PPP 296, 437  
 MM 414  
 mm/inches 434

- Mobile Twinned Call Pickup 252
- Mobile Twinning 14, 91, 252, 365
- mobile/cell 236, 242, 243, 350, 357, 371
- Mobile/Cell Phone 236, 242, 243, 350, 357
- Mobility 18, 146, 166, 170, 177, 227, 234
- Mobility Solutions 146
- Modify' 370
- Modify' existing lists 370
- Modular 14, 91, 346, 377
- Modular Messaging 377
- Modular Messaging Voicemail 346
- Monitor 98, 234, 247, 250, 279, 314, 335, 339, 340, 373, 375, 395, 413, 422, 423, 424
- Monitor Calls 250
- Most Avaya 244
- MP 437
- MPPC 437
- MSDE 375
- MSP 339
- Multiclass 275
- Multi-Class Extension
  - Multi-Link PPP 437
- Multiclass Extensions
  - Multilink PPP 275
- Multi-Level Tree Structure 378
- Multi-Link 296, 437
- Multilink PPP
  - Multiclass Extensions 275
- multiple incoming 238
- Multiple Mailboxes
  - Forward 378
- Multiple Subscriber Number 279
- Multiple Time Entries 249
- multipoint 256
  - point 279
- Multipoint Connection Units 256
- MultiVantage 289
- Mute 168, 169, 188, 190, 192, 217, 218, 244
- MWI 230
- N -**
- NA 146
- NAME 414
  - Calling 331
- NAT 11, 284, 297, 437
  - discover 281
- Netgear 271
- Network Address Translation 11, 284, 297, 437
- Network Address Translators 437
- network addresses 11, 284, 297, 437
- Network Alchemy 91
- Network Assessment 274
- network called
  - Public Switched 254
- network comprising 298
- Network Manager 423
- Network Manager application 423
- network numbering 291, 297
- Network Numbering Schemes 291
- network ready 6
- Network Requirements 272
- Network Time Protocol 437
- Networked Messaging 350, 363
- Networked Messaging Solution 363
- Networking Features 286
- Networking maximizes 277
- networks converging voice 170
- networks including private 254
- New message 230, 294, 362
- new/old/saved 231
- new/repeat/answered/unanswered 218
- NI2 279
- Night Service 248, 249, 343
- Night Service Fallback 248
  - Pass 249
- Night Service Group 248
- No Answer 236, 242, 243, 252, 331, 343
- No Answer Interval 242
- No Answer Time 236
- Node Numbering 291
- Node Numbering Scheme 291
- North American Primary Rate Interface 279
- North American T1 279
- Norwegian 168, 350, 367
- Not Disturb 233, 242, 244
- Not Disturb Exception Add 252
- Not Disturb Exception Delete 252
- Not Disturb Off 252
- Not Disturb On 252
- Notice 6
- Now there's 6
- NTP 437
- NULL Encryption Algorithm 437
- Number service 279, 365
- number/name 378
- number' 229
- Numeric Keystrokes 335
- Nylon Pouch 170
- O -**
- OAI 170
- Octel 289
- Of Hours 369
- Off Hook Current 437
- Off Hook Operation 251
- Off Hook Station 252
- Offer/Answer Model 437
- offering
  - high-resolution 170
  - high-resolution backlight 170
- Off-Hook Station 251
- office heating 350

- Office-quality speakerphone 173
- Oldest 250, 375
- oldest ringing/waiting 250
- oldest ringing/waiting call 250
- On Demand Call Recording 350
- Open Application Interface 170
- Open CTI 12
- OpenView application 423
- Operator SoftConsole 12
- Optional Add-Ons 142, 143, 144
- Other Avaya Products 107, 289
- Other Features 378, 395
- Out Of Hours 369
- Outbound Call Handling Features 240
- outcall 371
- Outcalling 378
- Outlook 12, 314, 361
  - Goldmine 314
- Output Port 221, 437
- Overflow Group 248
- Overhead LAN 273
- Overhead WAN 273
- P -**
- PABX's 10, 256
  - provide 14
- Packet Based 284
- Packet Based Voice Networking 284
- packet filtering 298
- packet switching 284
- packetization 275
- packetized VoIP
  - allowing 284
- packetized VoIP calls 284
- packets arrive
  - port 274
- packet-switched 254
- Packet-Switched Telephony 254
- Packet-switched VoIP 254
- Pager 357
- Paging
  - Calls 236
- Pan European Connection 437
- PAP 294, 297, 298, 299, 437
- Park 229, 230, 236, 252, 331, 335, 336, 344, 350, 372
- Park Call 252
- Park ID's 331
- Park Return 236
- Park Slot Panel 331, 335, 336
- Park Slots 229, 331, 335, 336, 344, 372
- pass calls 249
- Password 231, 294, 297, 336, 414, 437
- PC application 370
- PC application Phone Manager Pro 370
- PC Based 346
- PC Softphone 12, 91, 227, 314
- PC Softphones 18
- Permanent Virtual Circuits 284, 296
- Personal 365
- Personal Distribution Lists 314, 370
- Personal Numbering 350, 365, 378
- Personal Options 378
- Personalized Greeting 378
- Personalized Ring Patterns 142, 143, 144, 188, 190, 192
- Personalized Ringing 217, 230
- Phone 16 434
- Phone 16 Module 434
- Phone 30 Module 434
- Phone Manager application 232, 233
- Phone Manager Feature Summary 314
- Phone Manager GUI 369
- Phone Manager Lite 12, 91, 244
- Phone Manager Lite/Pro/PC Softphone 91
- Phone Manager PC Softphone 14, 254
- Phone Manager Pro 12, 14, 91, 221, 235, 236, 244, 314, 369, 370, 378
- Phone Manager Pro PC Softphone 91
- physical/logical 274
- Pickup 235
- Pick-Up 232
- PIN 12, 366, 378, 396
  - prompted 346
  - requesting 394
- PIN checking 366
- PIN Code By-Pass 378
- PIN code/menu 396
- Plain Old Telephone Services" 254
- Platform Support 378
- Play Advice
  - switching 373
- played back 369, 378
- PoE 107, 124, 142, 143, 144, 166, 188, 190, 192, 194, 254
- Point Compression
  - Microsoft Point 297, 437
- Point Protocol
  - Point 437
- Point-to-Point 279, 284, 293, 294, 296
- Point-to-Point Protocol 293, 296
- Power Distribution Units 124
- Power Fail Ports 437
- Power Options
  - IP Telephones 124
- Power Supply 124, 142, 143, 144, 188, 190, 192, 194, 434
- Power Supply Units 434
- Powered Data Unit 124
- Powered LAN 107
- PPP 275, 293, 296, 299, 437
- PPP Fragmentation 275

- PPP MP 437
  - PPP Multilink Protocol 437
  - PR 279
  - PRI 10, 11, 91, 93, 98, 277, 279, 437
  - PRI 30 E1 93
  - PRI 30 E1R2 RJ45 93
  - PRI E1 437
  - PRI ISDN Services 437
  - PRI ISDN Switch 437
  - PRI T1 11, 93, 437
  - PRI T1 Service 437
  - PRI T1/J1 437
  - prices—Avaya 6
  - Primary Rate ISDN 279
  - Primary Rate Trunks 98, 279
  - prioritization 170
  - Priority 6, 170, 188, 190, 192, 248, 252, 254, 343, 371
  - Priority Call 248, 252
  - Priority Processors 170
  - Privacy Mechanism
    - Session Initiation Protocol 437
  - Private 6, 98, 234, 240, 252, 254, 277, 278, 284, 289, 293, 297, 370, 371
  - Private Call 234, 252
  - Private Call Off 252
  - Private Call On 252
  - Private Circuit Switched 278
  - Private Circuit Switched Voice Networking 278
  - Private Networking 289
  - Private Voice Networks 98, 277
  - Pro 12, 221, 357, 396
    - upgrades 14
  - Pro provides 12
  - Product 6, 218, 250, 252, 271, 289, 337, 339, 340, 361
    - receiving 6
    - time during 14
  - product configuration documents 252
  - Product Configurations 252
  - Product Description 250
    - Operating System 337
  - Professional Edition 14, 395
    - Standard Edition 91
    - upgrade 91
  - prompting
    - PIN 346
    - Voicemail Pro 364
  - Protocol Applicability Statement 437
  - protocol passing 298
  - Protocols 98, 166, 170, 254, 256, 257, 272, 275, 284, 289, 296, 298, 361, 422, 437
  - protocols including 298
  - Proxy Address Resolution Protocol 298
  - PSK 173
  - PSTN 238, 272, 274
  - IP Office connects 254
    - SCN 241, 290
  - PSU 434
  - PTT 174
  - Public 6, 11, 98, 230, 240, 241, 249, 254, 256, 271, 274, 277, 279, 284, 295, 297, 299, 350, 370, 437
  - Public Network 240, 241, 256, 284
  - Public Switched 274
    - network called 254
  - Public Switched Telephone Network 274
    - called 254
  - Public Voice Networking 279
  - Pulse 235, 279
  - Push 221
  - push-to-talk” 170
  - Put\_EventFilter 342
  - PVCs 284, 296
- Q -**
- Q.931 275, 279, 284, 285
  - Q.931 signaling 279
  - QoS 10, 142, 143, 144, 170, 188, 190, 192, 272, 274, 284, 424
  - QoS Options 142, 143, 144, 188, 190, 192
  - QoS/Class
    - Service 274
  - QSIG 10, 238, 279, 286, 289
    - following 278
    - limit 91
    - running 377
    - terminates 278
  - QSIG Networking 10
  - QSIG provides
    - level 278
  - QSIG signaling 278
  - Quad Chargers
    - 3641 170
  - Quality Assurance 235
  - Queue Announcements 346, 350, 378
  - Queue Entry Announcement 378
  - Queue Manager 12
  - Queue Mode 335
  - Queue Panel 331
  - queue panel displays
    - bar 331
  - queue position 378
  - Queue Position Announcement 378
  - Queue Threshold Alert 250
  - Queue Update Announcement 378
  - QUEUING 414
  - Quick Charger 170
  - Quotas 293, 294, 296, 344
  - Quotas place 293
- R -**
- Radio Frequency 2.4000 173, 175

- Radio Frequency 2.4000 GHz 173
  - RAS 298
  - Rate Adaptation 437
  - Rating
    - 24V DC 434
  - reachability 6
  - reading
    - email 12
  - Real Time 12, 275, 350, 437
  - Real Time Control Protocol 275, 437
  - real time tracking 12
  - Reattempt 331
  - Reboot When Free 414
  - Rec 437
  - Recall button 217, 218
  - receiver's 254
  - Receiving Door 221
  - Reception 230, 251
    - Breakout 378
  - Rechargeable Battery 177
  - Reclaim Call 233
  - Record Message 252, 372
  - Record/Send 378
  - recorded message stating 372
  - Recording 373
    - Time 378
  - Recordings 372, 373, 375
  - Redial Button 177, 217
  - Region 146, 166, 216, 223
  - RegisterCallNotifications 342
  - relating
    - conferencing 396
  - Relay Off 252
  - Relay On 252, 350
  - Relay On/Off/Pulse 235
  - Relay Pulse 252
  - Release 4.0 424
  - Release 4.0.7. 166
  - Release 4.1 249, 295
  - Remote Access 11, 13, 18, 227, 293, 294, 298, 350
    - Mail Box 378
  - Remote Access Features 294
  - Remote Access Server 11, 13, 298
  - Remote Access Services 18, 227, 293, 294
  - Remote Hot Desking 234, 286
  - Remote Management 396
  - REN 437
  - Repeat Message 378
  - Replay 350, 375
  - replay rights 375
  - Reply 348, 362, 369, 378
  - requesting
    - Gatekeeper 256
    - PIN 394
  - Rest 293
    - World 395
  - restricted/allowed 298
  - Resume Call 252
  - Retrieve Call 252
  - Return On Investment 393
  - Rewind Message 378
  - RFA 289
  - RFC 275, 437
  - Ringer 142, 143, 144, 177, 217, 218, 230, 250
  - Ringer Equivalency 217
  - Ringer On/Off 177
  - Ringling
    - Patterns 217
    - Volume Control 217
  - RIP 11, 298, 437
  - RJ45 Ethernet 437
  - RMS 437
  - ROI 393
  - ROTARY 414
  - router alleviates 293
  - router/firewall/DHCP 13
  - Routing Information Protocol 298, 437
  - RTP 273, 281, 437
  - RTP Payload
    - DTMF Digits 437
  - RTP Relay 281
  - RTP Voice Data Payload 273
  - RTP/RTCP 275, 437
  - Ruggedized 173, 174, 176, 223
  - Russian 350, 367
  - RW 375
- S -**
- S Message 344
  - S0 279
  - S0 Endpoint
    - Call 279
  - S3210 289
  - Save Message 378
  - Save Profile 331
  - SBC 281
  - scalable 14, 277, 361
  - Scalable Platform 14
  - Scan' 370
  - SCN 91, 234, 249, 286
    - PSTN 241, 290
  - Screen Pop 314, 339
  - Screen-Popping 228
  - SDP 437
  - Search 335, 375
  - Secondary Dial Tone 233, 252
  - secretary's 233
  - Securing
    - L2TP 437
  - Security Architecture

- Security Architecture
  - Internet Protocol 437
- Self-Administration 247
- Send Email 378, 423
- Send Instant Messages 314
- Separated incoming/outgoing 314
- Series 14, 93, 102, 103, 107, 188, 190, 192, 194, 217, 223, 336, 340, 350, 434
- server PC's 434
- servers provide 297
- Service Packs 337
- Service Provider conferencing
  - compared 393
- Service Provider conferencing services 393
- service provider supporting 228
- Service Providers 10, 91, 228, 279, 281, 284, 299, 314, 393
- service-by-service 296
- Session Border Controller 281
- Session Description Protocol 437
- Session Initiation Protocol 254, 275, 281
  - Privacy Mechanism 437
- Set Absent Text 252
- Set Account Code 252
- Set Authorization Code 252
- Set Hunt Group Night Service 252
- Set Hunt Group Out
  - Service 252
- Set Hunt Group Out Of Service 252
- Set Inside Call Seq 252
- Set Message Priority 378
- Set Mobile Twinning Number 252
- Set Mobile Twinning Off 252
- Set Mobile Twinning On 252
- Set No Answer Time 252
- Set Outside Call Seq 252
- Set Ringback Seq 252
- Set Wrap Up Time 252
- SetCallInfoBuffer 342
- short code representing 372
- Short Codes 229, 249, 250, 252, 286, 297, 348, 372, 396
- Short Message System 357
- ShortCode.csv 414
- Shut Down Embedded Voicemail 252
- Signaling
  - Conforms 279
- Signaling Channels 166, 279
- Silence Suppression 257, 275
- Simple Network Management Protocol 423, 437
- Simple Outlook 314
- Simple Telephony Call/Basic 278, 289
- Simple Telephony Call/Basic Call 278, 289
- Simple Traversal
  - UDP 281
- User Datagram Protocol 437
- Simultaneous 274
- Simultaneous VoIP Calls
  - Maximum Number 274
- Small Community Network 229, 230, 232, 234, 235, 244, 249, 285, 286, 289, 350
- SMDR 91, 240, 339
- SMI 175
- SMS 357
- SMS/text 361
- SMTP 12, 350, 357, 413
- SMTP email 413
- SMTP/POP3 361
- SNMP 124, 142, 143, 144, 188, 190, 192, 284, 413, 423, 437
- SNMPv1 437
- So8 434
- So8 Module 434
- Soft 10, 173, 232
- SoftConsole 14, 91, 229, 232, 235, 244, 251, 331, 335, 336, 337
- SoftConsole Administration 336
- SoftConsole gives
  - operator 331
- SoftConsole Options 335
- SoftConsole PC Requirements 337
- SoftConsole Telephone Requirements 336
- Software Developers Kit 339
- Software Development Kit 12, 339
- SOHO 233
- Sophisticated Queue Announcement 350
- SOS Emergency key 168
- Speaker button 247
- Speaking Clock 350, 378
- Special Features
  - 4625 SW 192
  - 5410 190
  - 5420 192
  - 5621 SW 192
- Special Services 279
- Specialty Handset Support 217
- Speed Dial 190, 192, 244, 314
- Speed Dial List 190, 192
- Sprint 279
- SQL 366
- SQL Query Builder Wizard 366
- SSA 424
- SSA connects 424
- SS-CNIP 278
- SS-CNIR 278
- SS-CONP 278
- SS-CT 278
- SS-MWI 278
- SSS 279
- STAC 437

- Stac Lemple Ziv 297
- STAC LZS Compression Protocol 437
- stackable 91
- Stand
  - Charging 177
- Stand Power Supply Adapter
  - Charging 177
- Standard 40W Power Supply Unit 434
- Standard Edition 14
  - Professional Edition 91
- standards-based 10, 11, 248
- standards-based TAPI 248
- Starter Kits” 166
- starting
  - Day One 6
- station/access 107
- Status 13, 91, 175, 194, 232, 234, 238, 244, 248, 331, 335, 340, 350, 375, 413, 424
- Status Application 13, 91, 424
- Status Bar 331
- STD15 437
- STD16 437
- STD17 437
- STD56 437
- STD57 437
- Still Queued 350
- strings 279
  - Absence Text 232
- Structured Query Language 366
- STUN 281, 437
- Sub-addressing
  - Allows 279
- subject 6, 228, 250, 373
  - email 357
- Summary 98, 223, 274
  - Positioning 346
- Supervised Transfer
  - called 230
- supervisor's Coverage Timer 236
- Supervisors 233, 236, 370
- Supplementary Service 284, 285
- Supplementary Services within 285
- Supplementary Services within IP Networks 285
- Suspend Call 252
- Suspend CW 252
- Sv 344
- SW 188, 190, 192
- SwapHold 342
- Swedish 168, 169, 350
- switchable 190, 192, 218
- Switchable Time Break Recall 100 218
- Switched Ethernet 11, 91
- Switched LAN 14
- switching
  - Capacity 437
  - Play Advice 373
  - WAN 284
  - synchronization 298, 378
    - Phone Manager 11
  - System Administration 375
  - System Administrator 229, 230, 233, 252, 373, 375
  - System Announcement 378
  - systems supporting 363
- T -
- T.38 257
- T1 10, 11, 14, 98, 230, 238, 241, 277, 278, 279, 289, 290, 296, 377, 395
- T3 103, 107, 142, 143, 144, 223, 231, 279, 434
- Tabs 314, 331, 335, 396
- TAPI 12, 91, 228, 339, 340, 341, 342, 343
- TAPILink Lite 339, 340, 341, 342
- TAPILink Pro 339, 340
- TAPI-WAV 339, 340
- Target RAS 344
- TCP 437
- TCP/IP 13, 437
- TCP/UDP/IP 275
- Technical Bulletin 281, 337
- Technical Specifications 337
- Technology Overview 256
- telecommunication 437
- telecommunication numbering 437
- Telecommuter 236, 314
- Telecommuter Mode 236, 314
- teleconferences 6
- Telephone Adaptors 13, 294
- Telephone Cord 177
- Telephone Devices 340
- telephone establish 256
- Telephone Extension Cable Lengths 434
- Telephone Options 14
- Telephone User Interface 350, 369, 370, 371
- telephone wishing 256
- telephones including 10
- telephones operating 274
- Telephones Section 103
- telephones utilizing Power 124
- Telephony Functions 18, 227
- Telephony Signals 437
- Telephony Tones 437
- telesales 350
- Test Conditions 378
- Text To Speech 12, 14, 350, 362, 367, 378
- Text” 364
- Text-to-Speech 350
- TFTP 170, 173, 175, 274, 437
- that's 6
- that's right 6
- There's 6



- Third Party Database Access 378
- Third Party Fax 361
- Third Party Text
  - Speech 14
- Third Party Text To Speech 14
- Through Network Address Translators 437
- TIA/EIA-646-B
  - conform 279
- til 232
- Time Division Multiplexing 91
- time during
  - product 14
- Time Entries 249
- time linking
  - office 293
- Time Profile 234, 248, 249, 297, 343, 371, 373
- timebands 294
- Time-Division Multiplexed Telephony 254
- timeframe 378
- timeout 229, 343, 371
- TNS 279
- To Email 350, 357, 378
- Toggle Calls 229, 252
- toolkit 339
- toolset 12
- toolset including 12
- Total base-stations/repeaters 166
- Transfer call 331
  - operator 378
- Transmission Control Protocol 437
- transmission/reception 279
- Transmit Power 100mw 175
- TransTalk 9040 107
- Tray 331, 336
- Tray working 336
- Trivial File Transfer Protocol 437
- Trunk Cards 93, 98
- Trunk Interfaces 10, 14
- trunk lines 238
- trunk providing 98
- trunk/extension 98
- trunk/VoIP 395
- Trunks back 14
- trunks/VoIP 396
- TTS 362
  - adds 367
- TTS Licensing 367
- TTY 350
- TTY hearing 350
- TUI 350, 369, 370, 371
- Tunneling Protocol 299, 437
- two-base-station 166
- U -**
- UC Module 301
- UK 350, 367
- UK20 437
- unencrypted 297
- Uni 93
- Unified Communications Module 301
- Universal PRI 98
- Unlike circuit-switched 254
- unmaps 297
- Unpark 252, 342
- Unpark Call 252
- Unread 'User 331
- unsecured' 295
- Unshielded Twisted-Pair 434
- Unstructured Private Circuit 284
- Upgrade License 91, 395
- upgradeable 142, 143, 144, 170, 188, 190, 192
- Upgradeable Firmware 142, 143, 144, 188, 190, 192
- Upgrade-Kit" 166
- upgrade-license 166
- Upn 142, 223, 434
- UPS 124, 434
- USA 437
- USA Interfaces 437
- use depending 98
- Use mailing 378
- user according
  - type 336
- user acquiring
  - call 250
- User CD-Rom 339
- user collecting 294
- User Datagram Protocol
  - Simple Traversal 437
- user determines 238
- user ensuring 223
- user executing 250
- User Interface 12, 173, 254, 350
- user interface offering 254
- user making 243
- user name 331, 344
- User Recording 373
- user restricting 298
- USER RIGHT 414
- User Rights 240, 414
- Using Text To Speech 12, 367
- UTP 434
- V -**
- V.24 296, 437
- V.24 Interface
  - 19.2Kbps 437
- V.24/V.28 437
- V.32 98, 294
- V.35 284, 293, 296, 437
- V.90 14, 294
- V.90 56Kbps 294

- V110 437
- V120 437
- V24 296
- V35 296
- V5.0 375
- V90 11
- VAC 124
- VB 14, 350, 368
- VB Scripts 14, 350, 368
- VCM 10, 91, 93, 142, 166, 235, 272, 274, 281, 284, 286, 378, 423, 424
- Virtual 254, 271, 284, 296, 393
  - Voicemail 378
- Virtual Office 271
- Visual Basic 342, 350, 368, 378
- Visual Basic Scripts 378
- Visual Message Waiting Indication 218
- Visual Voice 231, 348, 350, 378
- Visual Voice NOT 231
- VLAN 142, 143, 144, 188, 190, 192
- VM 242
- Voice Call 248, 273, 289
- Voice Communication Solution 10
- Voice Communication Solution Features 10
- Voice Compression 14, 93, 166, 256, 257, 272, 274, 281, 284, 348
- Voice Compression Module 256, 257, 272, 274, 284
- Voice encoding 173
- Voice encoding G711 175
- Voice Forms/Questionnaire Mailboxes 350
- Voice Mail 6, 168, 169, 242, 331, 371
- Voice Messaging 10
- Voice Networking 14, 91
- Voice Priority Processors 170
- voice processing 339
- Voice Recording 235, 350, 373
- Voice Recording Library” 375
- voice samples
  - telephone 272
- voice traffic 170, 272, 274, 294
- VoiceDirector 279
- Voicemail 12, 14, 18, 91, 190, 192, 221, 227, 230, 231, 233, 234, 235, 236, 238, 239, 240, 243, 249, 250, 252, 257, 277, 286, 289, 294, 314, 331, 343, 344, 346, 361, 362, 363, 364, 365, 366, 367, 368, 370, 371, 372, 373, 375, 377, 394, 396, 414, 423, 424, 434
  - alter 248
  - control 348, 350
  - distribute 370
  - Email 357
  - Forwarding 350, 357
  - Hunt Groups 378
  - Individual 378
  - Interaction 357
  - IP500 348
  - PC 348
  - routed 369
  - Virtual 378
  - Voicemail Box Feature 378
  - Voicemail Breakout/Personal Auto-Attendant 348
  - Voicemail Collect 252, 348
  - Voicemail email 343, 365
  - Voicemail email forwarding 365
  - Voicemail Feature Comparison 378
  - voicemail greeting 12
  - Voicemail Help TUI 378
  - Voicemail Node 252
  - Voicemail Off 252
  - Voicemail On 252, 343, 365
  - Voicemail Ports 235, 373
  - VoiceMail Pro 12, 14, 91, 231, 235, 249, 286, 289, 331, 346, 350, 361, 362, 363, 365, 366, 368, 369, 370, 371, 372, 373, 375, 378, 394, 396, 423
    - pool 367
    - prompting 364
  - VoiceMail Pro application 221
  - Voicemail Pro Client 350, 364, 366, 371, 373
  - VoiceMail Pro Fax 361
  - VoiceMail Pro Manager 364, 378
  - VoiceMail Pro Networked Messaging 14, 289, 370
  - VoiceMail Pro Networked Messaging RFA 289
  - VoiceMail Pro Server 289, 350, 362, 363, 368
  - voicemail ringback 230, 252, 378
  - Voicemail Ringback Off 252
  - Voicemail Ringback On 252
  - Voicemail Server 289, 294, 346, 350
  - Voicemail System 371, 375
  - Voicemails 231, 236, 357, 362, 378
  - VoIP 6, 10, 14, 93, 146, 170, 222, 254, 257, 272, 273, 274, 275, 277, 284, 289, 314, 424
  - VoIP application 274
  - VoIP calls 273
  - VoIP provides 254
  - VoIP Standards Supported 275
  - VoIP Wi-Fi Solution 146
  - VoIP-compatible 254
  - Voltage 124, 218, 437
  - Volts 124
  - Volts Alternating Current 124
  - Volume 168, 169, 188, 190, 192, 217, 218, 244, 364, 378
  - Volume Control
    - Ringling 217
  - Volume Down 188, 190, 192
  - Volume Up 188, 190, 192
  - VPIM 378
  - VPN 11, 14, 91, 271, 284, 299
    - following 146
  - VPN IPSec/L2TP 14
  - VPN Phone Software 271

- VPN Phones 14, 91, 146
  - Licenses 271
- VPN tunneling 14
- VPN-access 271
- VPN-gateways 271
- W -**
- waiting
  - Acquire Call 250
- walkie 170
- walkie-talkie 176
- Wall Plate Adapter 177
- WAN 11, 13, 91, 166, 272, 273, 277, 293, 294, 296, 299, 350, 422, 437
  - switching 284
  - VCM 272
- WAN link 293
- WAN multiplexers 294
- WAN3 91, 102, 423, 434
- WAN3 10/100 91, 102
- WAN3 Module 423, 434
- WAP WML 190, 192
- Warm Start 414
- Watts 124, 434
- WAV 229, 314, 335, 357, 362, 375
- wav file 229, 314, 375
- waveform 375
- Web 6, 11, 372, 373, 375
- Web Server 375
- Web site 11
- Week Planner 350
- WEP 173, 175
- what's 254
- Whisper Announce 350, 378
- Wide Area 102, 166, 284, 293, 296, 297
- Wide Area Expansion 284
- Wide Area Network 166, 293, 297
- Wide Area Networking Protocol 296
- Width 168, 434
- WiFi 14, 107, 170, 173, 174, 175, 176, 223
- Wink-Start 279
- WINS 296
- Wire 10, 107, 142, 143, 144, 170, 173, 175, 254, 274, 336
  - closet/switch 124
- wire speed 274
- Wired Equivalent Privacy 173, 175
- Wireless 6, 10, 14, 18, 103, 107, 124, 146, 166, 170, 175, 177, 223, 227, 254, 437
- Wireless Access Points 14, 170
- Wireless Module 437
- Wireless Telephones 14, 107, 146, 170, 175, 177, 223
- Wireless VoIP 14
- Within SoftConsole 331
- WLAN 124, 170
- WLAN Compatibility List" 170
- workflow 350
- workforce 361
- workgroup 174
- workgroups 12
- World 216, 254, 293
  - Rest 395
- WorldCom 279
- worlds companies' LANs 254
- Worst Case 124, 434
- Wrap Up 343
- WS-X4148-RJ45V 124
- WS-X6348-RJ45V 124
- X -**
- X.21 284, 293, 296, 437
- X.25 296
- XM24 103, 223
- XM24 DSS Unit 223
- Y -**
- Year 6
- Yes 142, 143, 144, 188, 190, 192, 314, 346, 378
- Z -**
- Zetafax
  - Networks 361

Performance figures and data quoted in this document are typical, and must be specifically confirmed in writing by Avaya before they become applicable to any particular order or contract. The company reserves the right to make alterations or amendments to the detailed specifications at its discretion. The publication of information in this document does not imply freedom from patent or other protective rights of Avaya or others.

All trademarks identified by the ® or ™ are registered trademarks or trademarks, respectively, of Avaya Inc. All other trademarks are the property of their respective owners.

This document contains proprietary information of Avaya and is not to be disclosed or used except in accordance with applicable agreements.

© 2012 Avaya Inc. All rights reserved.