



# **IP Office™ Platform 9.1**

**Deploying Avaya IP Office™ Platform  
IP500 V2**

#### Notice

While reasonable efforts have been made to ensure that the information in this document is complete and accurate at the time of printing, Avaya assumes no liability for any errors. Avaya reserves the right to make changes and corrections to the information in this document without the obligation to notify any person or organization of such changes.

#### Documentation disclaimer

"Documentation" means information published by Avaya in varying mediums which may include product information, operating instructions and performance specifications that Avaya may generally make available to users of its products and Hosted Services. Documentation does not include marketing materials. Avaya shall not be responsible for any modifications, additions, or deletions to the original published version of documentation unless such modifications, additions, or deletions were performed by Avaya. End User agrees to indemnify and hold harmless Avaya, Avaya's agents, servants and employees against all claims, lawsuits, demands and judgments arising out of, or in connection with, subsequent modifications, additions or deletions to this documentation, to the extent made by End User.

#### Link disclaimer

Avaya is not responsible for the contents or reliability of any linked websites referenced within this site or documentation provided by Avaya. Avaya is not responsible for the accuracy of any information, statement or content provided on these sites and does not necessarily endorse the products, services, or information described or offered within them. Avaya does not guarantee that these links will work all the time and has no control over the availability of the linked pages.

#### Warranty

Avaya provides a limited warranty on Avaya hardware and software. Refer to your sales agreement to establish the terms of the limited warranty. In addition, Avaya's standard warranty language, as well as information regarding support for this product while under warranty is available to Avaya customers and other parties through the Avaya Support website: <https://support.avaya.com/helpcenter/getGenericDetails?detailId=C20091120112456651010> under the link "Warranty & Product Lifecycle" or such successor site as designated by Avaya. Please note that if You acquired the product(s) from an authorized Avaya Channel Partner outside of the United States and Canada, the warranty is provided to You by said Avaya Channel Partner and not by Avaya.

"Hosted Service" means a hosted service subscription that You acquire from either Avaya or an authorized Avaya Channel Partner (as applicable) and which is described further in Hosted SAS or other service description documentation regarding the applicable hosted service. If You purchase a Hosted Service subscription, the foregoing limited warranty may not apply but You may be entitled to support services in connection with the Hosted Service as described further in your service description documents for the applicable Hosted Service. Contact Avaya or Avaya Channel Partner (as applicable) for more information.

#### Hosted Service

THE FOLLOWING APPLIES IF YOU PURCHASE A HOSTED SERVICE SUBSCRIPTION FROM AVAYA OR AN AVAYA CHANNEL PARTNER (AS APPLICABLE), THE TERMS OF USE FOR HOSTED SERVICES ARE AVAILABLE ON THE AVAYA WEBSITE, [HTTPS://SUPPORT.AVAYA.COM/LICENSEINFO](https://support.avaya.com/licenseinfo) UNDER THE LINK "Avaya Terms of Use for Hosted Services" OR SUCH SUCCESSOR SITE AS DESIGNATED BY AVAYA, AND ARE APPLICABLE TO ANYONE WHO ACCESSES OR USES THE HOSTED SERVICE. BY ACCESSING OR USING THE HOSTED SERVICE, OR AUTHORIZING OTHERS TO DO SO, YOU, ON BEHALF OF YOURSELF AND THE ENTITY FOR WHOM YOU ARE DOING SO (HEREINAFTER REFERRED TO INTERCHANGEABLY AS "YOU" AND "END USER"), AGREE TO THE TERMS OF USE. IF YOU ARE ACCEPTING THE TERMS OF USE ON BEHALF A COMPANY OR OTHER LEGAL ENTITY, YOU REPRESENT THAT YOU HAVE THE AUTHORITY TO BIND SUCH ENTITY TO THESE TERMS OF USE. IF YOU DO NOT HAVE SUCH AUTHORITY, OR IF YOU DO NOT WISH TO ACCEPT THESE TERMS OF USE, YOU MUST NOT ACCESS OR USE THE HOSTED SERVICE OR AUTHORIZE ANYONE TO ACCESS OR USE THE HOSTED SERVICE. YOUR USE OF THE HOSTED SERVICE SHALL BE LIMITED BY THE NUMBER AND TYPE OF LICENSES PURCHASED UNDER YOUR CONTRACT FOR THE HOSTED SERVICE, PROVIDED, HOWEVER, THAT FOR CERTAIN HOSTED SERVICES IF APPLICABLE, YOU MAY HAVE THE OPPORTUNITY TO USE FLEX LICENSES, WHICH WILL BE INVOICED ACCORDING TO ACTUAL USAGE ABOVE THE CONTRACT LICENSE LEVEL. CONTACT AVAYA OR AVAYA'S CHANNEL PARTNER FOR MORE INFORMATION ABOUT THE LICENSES FOR THE APPLICABLE HOSTED SERVICE, THE AVAILABILITY OF ANY FLEX LICENSES (IF APPLICABLE), PRICING AND BILLING INFORMATION, AND OTHER IMPORTANT INFORMATION REGARDING THE HOSTED SERVICE.

#### Licenses

THE SOFTWARE LICENSE TERMS AVAILABLE ON THE AVAYA WEBSITE, [HTTPS://SUPPORT.AVAYA.COM/LICENSEINFO](https://support.avaya.com/licenseinfo), UNDER THE LINK "AVAYA SOFTWARE LICENSE TERMS (Avaya Products)" OR SUCH SUCCESSOR SITE AS DESIGNATED BY AVAYA, ARE APPLICABLE TO ANYONE WHO DOWNLOADS, USES AND/OR INSTALLS AVAYA SOFTWARE, PURCHASED FROM AVAYA INC., ANY AVAYA AFFILIATE, OR AN AVAYA CHANNEL PARTNER (AS APPLICABLE) UNDER A COMMERCIAL AGREEMENT WITH AVAYA OR AN AVAYA CHANNEL PARTNER. UNLESS OTHERWISE AGREED TO BY AVAYA IN WRITING, AVAYA DOES NOT EXTEND THIS LICENSE IF THE SOFTWARE WAS OBTAINED FROM ANYONE OTHER THAN AVAYA, AN AVAYA AFFILIATE OR AN AVAYA CHANNEL PARTNER; AVAYA RESERVES THE RIGHT TO TAKE LEGAL ACTION AGAINST YOU AND ANYONE ELSE USING OR SELLING THE SOFTWARE WITHOUT A LICENSE. BY INSTALLING, DOWNLOADING OR USING THE SOFTWARE, OR AUTHORIZING OTHERS TO DO SO, YOU, ON BEHALF OF YOURSELF AND THE ENTITY FOR WHOM YOU ARE INSTALLING, DOWNLOADING OR USING THE SOFTWARE (HEREINAFTER REFERRED TO INTERCHANGEABLY AS "YOU" AND "END USER"), AGREE TO THESE TERMS AND CONDITIONS AND CREATE A BINDING CONTRACT BETWEEN YOU AND AVAYA INC. OR THE APPLICABLE AVAYA AFFILIATE ("AVAYA").

Avaya grants You a license within the scope of the license types described below, with the exception of Heritage Nortel Software, for which the scope of the license is detailed below. Where the order documentation does not expressly identify a license type, the applicable license will be a Designated System License. The applicable number of licenses and units of capacity for which the license is granted will be one (1), unless a different number of licenses or units of capacity is specified in the documentation or other materials available to You. "Software" means computer programs in object code, provided by Avaya or an Avaya Channel Partner, whether as stand-alone products, pre-installed on hardware products, and any upgrades, updates, patches, bug fixes, or modified versions thereto. "Designated Processor" means a single stand-alone computing device. "Server" means a Designated Processor that hosts a software application to be accessed by multiple users. "Instance" means a single copy of the Software executing at a particular time: (i) on one physical machine; or (ii) on one deployed software virtual machine ("VM") or similar deployment.

#### License type(s)

Designated System(s) License (DS). End User may install and use each copy or an Instance of the Software only on a number of Designated Processors up to the number indicated in the order. Avaya may require the Designated Processor(s) to be identified in the order by type, serial number, feature key, Instance, location or other specific designation, or to be provided by End User to Avaya through electronic means established by Avaya specifically for this purpose.

Concurrent User License (CU). End User may install and use the Software on multiple Designated Processors or one or more Servers, so long as only the licensed number of Units are accessing and using the Software at any given time. A "Unit" means the unit on which Avaya, at its sole discretion, bases the pricing of its licenses and can be, without limitation, an agent, port or user, an e-mail or voice mail account in the name of a person or corporate function (e.g., webmaster or helpdesk), or a directory entry in the administrative database utilized by the Software that permits one user to interface with the Software. Units may be linked to a specific, identified Server or an Instance of the Software.

Database License (DL). End User may install and use each copy or an Instance of the Software on one Server or on multiple Servers provided that each of the Servers on which the Software is installed communicates with no more than one Instance of the same database.

CPU License (CP). End User may install and use each copy or Instance of the Software on a number of Servers up to the number indicated in the order provided that the performance capacity of the Server(s) does not exceed the performance capacity specified for the Software. End User may not re-install or operate the Software on Server(s) with a larger performance capacity without Avaya's prior consent and payment of an upgrade fee.

Named User License (NU). You may: (i) install and use each copy or Instance of the Software on a single Designated Processor or Server per authorized Named User (defined below); or (ii) install and use each copy or Instance of the Software on a Server so long as only authorized Named Users access and use the Software. "Named User", means a user or device that has been expressly authorized by Avaya to access and use the Software. At Avaya's sole discretion, a "Named User" may be, without limitation, designated by name, corporate function (e.g., webmaster or helpdesk), an e-mail or voice mail account in the name of a person or corporate function, or a directory entry in the administrative database utilized by the Software that permits one user to interface with the Software.

Shrinkwrap License (SR). You may install and use the Software in accordance with the terms and conditions of the applicable license agreements, such as "shrinkwrap" or "clickthrough" license accompanying or applicable to the Software ("Shrinkwrap License").

#### Heritage Nortel Software

"Heritage Nortel Software" means the software that was acquired by Avaya as part of its purchase of the Nortel Enterprise Solutions Business in December 2009. The Heritage Nortel Software is the software contained within the list of Heritage Nortel Products located at <https://support.avaya.com/LicenseInfo> under the link "Heritage Nortel Products" or such successor site as designated by Avaya. For Heritage Nortel Software, Avaya grants Customer a license to use Heritage Nortel Software provided hereunder solely to the extent of the authorized activation or authorized usage level, solely for the purpose specified in the Documentation, and solely as embedded in, for execution on, or for communication with Avaya equipment. Charges for Heritage Nortel Software may be based on extent of activation or use authorized as specified in an order or invoice.

#### Copyright

Except where expressly stated otherwise, no use should be made of materials on this site, the Documentation, Software, Hosted Service, or hardware provided by Avaya. All content on this site, the documentation, Hosted Service, and the product provided by Avaya including the selection, arrangement and design of the content is owned either by Avaya or its licensors and is protected by copyright and other intellectual property laws including the sui generis rights relating to the protection of databases. You may not modify, copy, reproduce, republish, upload, post, transmit or distribute in any way any content, in whole or in part, including any code and software unless expressly authorized by Avaya. Unauthorized reproduction, transmission, dissemination, storage, and or use without the express written consent of Avaya can be a criminal, as well as a civil offense under the applicable law.

#### Virtualization

The following applies if the product is deployed on a virtual machine. Each product has its own ordering code and license types. Note that each Instance of a product must be separately licensed and ordered. For example, if the end user customer or Avaya Channel Partner would like to install two Instances of the same type of products, then two products of that type must be ordered.

#### Third Party Components

"Third Party Components" mean certain software programs or portions thereof included in the Software or Hosted Service may contain software (including open source software) distributed under third party agreements ("Third Party Components"), which contain terms regarding the rights to use certain portions of the Software ("Third Party Terms"). As required, information regarding distributed Linux OS source code (for those products that have distributed Linux OS source code) and identifying the copyright holders of the Third Party Components and the Third Party Terms that apply is available in the products, Documentation or on Avaya's website at: <https://support.avaya.com/Copyright> or such successor site as designated by Avaya. The open source software license terms provided as Third Party Terms are consistent with the license rights granted in these Software License Terms, and may contain additional rights benefiting You, such as modification and distribution of the open source software. The Third Party Terms shall take precedence over these Software License Terms, solely with respect to the applicable Third Party Components to the extent that these Software License Terms impose greater restrictions on You than the applicable Third Party Terms.

The following applies if the H.264 (AVC) codec is distributed with the product. THIS PRODUCT IS LICENSED UNDER THE AVC PATENT PORTFOLIO LICENSE FOR THE PERSONAL USE OF A CONSUMER OR OTHER USES IN WHICH IT DOES NOT RECEIVE REMUNERATION TO (i) ENCODE VIDEO IN COMPLIANCE WITH THE AVC STANDARD ("AVC VIDEO") AND/OR (ii) DECODE AVC VIDEO THAT WAS ENCODED BY A CONSUMER ENGAGED IN A PERSONAL ACTIVITY AND/OR WAS OBTAINED FROM A VIDEO PROVIDER LICENSED TO PROVIDE AVC VIDEO. NO LICENSE IS GRANTED OR SHALL BE IMPLIED FOR ANY OTHER USE. ADDITIONAL INFORMATION MAY BE OBTAINED FROM MPEG LA, L.L.C. SEE [HTTP://WWW.MPEGLA.COM](http://www.mpegla.com).

#### Service Provider

THE FOLLOWING APPLIES TO AVAYA CHANNEL PARTNER'S HOSTING OF AVAYA PRODUCTS OR SERVICES. THE PRODUCT OR HOSTED SERVICE MAY USE THIRD PARTY COMPONENTS SUBJECT TO THIRD PARTY TERMS AND REQUIRE A SERVICE PROVIDER TO BE INDEPENDENTLY LICENSED DIRECTLY FROM THE THIRD PARTY SUPPLIER. AN AVAYA CHANNEL PARTNER'S HOSTING OF AVAYA PRODUCTS MUST BE AUTHORIZED IN WRITING BY AVAYA AND IF THOSE HOSTED PRODUCTS USE OR EMBED CERTAIN THIRD PARTY SOFTWARE, INCLUDING BUT NOT LIMITED TO MICROSOFT SOFTWARE OR CODECS, THE AVAYA CHANNEL PARTNER IS REQUIRED TO INDEPENDENTLY OBTAIN ANY APPLICABLE LICENSE AGREEMENTS, AT THE AVAYA CHANNEL PARTNER'S EXPENSE, DIRECTLY FROM THE APPLICABLE THIRD PARTY SUPPLIER.

WITH RESPECT TO CODECS, IF THE AVAYA CHANNEL PARTNER IS HOSTING ANY PRODUCTS THAT USE OR EMBED THE G.729 CODEC, H.264 CODEC, OR H.265 CODEC, THE AVAYA CHANNEL PARTNER ACKNOWLEDGES AND AGREES THE AVAYA CHANNEL PARTNER IS RESPONSIBLE FOR ANY AND ALL RELATED FEES AND/OR ROYALTIES. THE G.729 CODEC IS LICENSED BY SIPRO LAB TELECOM INC. SEE [WWW.SIPRO.COM/CONTACT.HTML](http://WWW.SIPRO.COM/CONTACT.HTML). THE H.264 (AVC) CODEC IS LICENSED UNDER THE AVC PATENT PORTFOLIO LICENSE FOR THE PERSONAL USE OF A CONSUMER OR OTHER USES IN WHICH IT DOES NOT RECEIVE REMUNERATION TO: (I) ENCODE VIDEO IN COMPLIANCE WITH THE AVC STANDARD ("AVC VIDEO") AND/OR (II) DECODE AVC VIDEO THAT WAS ENCODED BY A CONSUMER ENGAGED IN A PERSONAL ACTIVITY AND/OR WAS OBTAINED FROM A VIDEO PROVIDER LICENSED TO PROVIDE AVC VIDEO. NO LICENSE IS GRANTED OR SHALL BE IMPLIED FOR ANY OTHER USE. ADDITIONAL INFORMATION FOR H.264 (AVC) AND H.265 (HEVC) CODECS MAY BE OBTAINED FROM MPEG LA, L.L.C. SEE [HTTP://WWW.MPEGLA.COM](http://WWW.MPEGLA.COM).

#### Compliance with Laws

Customer acknowledges and agrees that it is responsible for complying with any applicable laws and regulations, including, but not limited to laws and regulations related to call recording, data privacy, intellectual property, trade secret, fraud, and music performance rights, in the country or territory where the Avaya product is used.

#### Preventing Toll Fraud

"Toll Fraud" is the unauthorized use of your telecommunications system by an unauthorized party (for example, a person who is not a corporate employee, agent, subcontractor, or is not working on your company's behalf). Be aware that there can be a risk of Toll Fraud associated with your system and that, if Toll Fraud occurs, it can result in substantial additional charges for your telecommunications services.

#### Avaya Toll Fraud intervention

If You suspect that You are being victimized by Toll Fraud and You need technical assistance or support, call Technical Service Center Toll Fraud Intervention Hotline at +1-800-643-2353 for the United States and Canada. For additional support telephone numbers, see the Avaya Support website: <https://support.avaya.com> or such successor site as designated by Avaya.

#### Security Vulnerabilities

Information about Avaya's security support policies can be found in the Security Policies and Support section of <https://support.avaya.com/security>. Suspected Avaya product security vulnerabilities are handled per the Avaya Product Security Support Flow (<https://support.avaya.com/css/P8/documents/100161515>).

#### Downloading Documentation

For the most current versions of Documentation, see the Avaya Support website: <https://support.avaya.com>, or such successor site as designated by Avaya.

#### Contact Avaya Support

See the Avaya Support website: <https://support.avaya.com> for product or Hosted Service notices and articles, or to report a problem with your Avaya product or Hosted Service. For a list of support telephone numbers and contact addresses, go to the Avaya Support website: <https://support.avaya.com> (or such successor site as designated by Avaya), scroll to the bottom of the page, and select Contact Avaya Support.

# Contents

## 1. System Overview

1.1 Additional Documentation.....	12
1.2 Repair .....	12
1.3 RoHS .....	12
1.4 IP Office Modes.....	13
1.4.1 System SD Cards.....	14
1.4.2 Overall Capacity.....	15
1.4.3 Hardware Support Summary.....	16
1.4.4 Feature Support Summary.....	17
1.5 The Control Unit.....	18
1.6 IP500 V2 System Components.....	19
1.7 Control Unit Cards.....	21
1.7.1 IP500 Base Cards.....	21
1.7.2 IP500 Trunk Cards.....	24
1.8 External Expansion Modules.....	25
1.8.1 IP500 External Expansion Modules.....	26
1.8.2 IP400 External Expansion Modules.....	28
1.8.3 Connecting External Expansion Modules.....	29
1.9 Power Supplies and Cables.....	30
1.9.1 Power Supplies.....	30
1.9.2 Power Supply Cords.....	31
1.9.3 Power Supply Backup.....	32
1.9.4 Cabling and Cables.....	33
1.9.5 Grounding.....	35
1.9.6 Lightning Protection/Out-of-Building Connections.....	36
1.10 Wall and Rack Mounting.....	37
1.11 Feature Keys and Licenses.....	38
1.12 IP Office Phones.....	39
1.13 VoIP .....	41
1.13.1 Voice Compression Channels.....	42
1.14 Supported Country Locales.....	43
1.15 IP Office Software Applications.....	44
1.15.1 Programming Applications.....	45
1.15.2 User Applications.....	46
1.15.3 Voicemail Applications.....	46
1.15.4 Call Logging Applications.....	47
1.15.5 Call Center Applications.....	47
1.15.6 CTI Applications.....	47
1.16 Training .....	48
1.17 Web Sites.....	48
1.18 Emergency and Power Failure Ports.....	49

## 2. Installation Overview

2.1 Environmental Requirements.....	53
2.2 Space Requirements.....	54
2.2.1 Control Unit.....	55
2.2.2 External Expansion Modules.....	56
2.2.3 Wall Mounting.....	57
2.2.4 Rack Space Requirements.....	58
2.3 Tools and Equipment Required.....	59
2.4 Documentation.....	60
2.5 Unpacking.....	61

## 3. Installing the Admin Software

3.1 Downloading the Software.....	64
-----------------------------------	----

3.2 Installing the Admin Applications.....	66
3.3 Installer PC Connection.....	68
3.4 Starting IP Office Manager.....	69
3.5 Starting System Status Application.....	70
3.6 Starting System Monitor.....	71
3.7 IP Office Web Manager.....	72

## 4. Preparing the System SD Card

4.1 Upgrade the Card Firmware.....	75
4.2 Creating an Offline Configuration File.....	76
4.3 Adding a Pre-Built Configuration File.....	77
4.4 Adding a License File.....	77
4.5 Adding Security Certificates.....	77
4.6 Adding a 9600 Series Screen Saver File.....	78
4.7 Adding Music on Hold Files.....	78

## 5. Installing the Control Unit Cards

5.1 Fitting IP500 Daughter Cards.....	81
5.2 Inserting IP500 Base Cards.....	82

## 6. Installing the Physical System

6.1 Wall Mounting.....	85
6.1.1 Wall Mounting Kit V2/V3.....	86
6.2 Rack Mounting.....	87
6.3 Connecting External Expansion Modules.....	88
6.4 Grounding.....	90
6.5 Network Connection.....	91
6.6 Starting the System.....	92
6.7 Checking the LEDs.....	93
6.8 Connecting Phones.....	95
6.8.1 Analog Phones.....	95
6.8.2 ETR Phones.....	95
6.8.3 DS Digital Station Phones.....	95
6.8.4 TCM/BST Phones.....	95
6.8.5 IP/SIP Phones.....	96

## 7. Configuration Using IP Office Manager

7.1 Initial Configuration.....	99
7.2 Entering Licenses.....	101
7.3 Setting the System Locale.....	102
7.4 Changing the IP Address Settings.....	103
7.5 Extension Numbering.....	104
7.6 Disable Unused Trunks.....	106
7.7 Setting the Digital Trunk Clock Source.....	108
7.8 Setting the Trunk Prefixes.....	110
7.9 DS16B/30B Port Mode Selection.....	112

## 8. Securing the System

8.1 Changing the Default Security Settings.....	115
8.2 Changing the Remote User Password.....	116
8.3 Disabling SIP Trunk Support.....	116
8.4 Disabling H.323 Telephone Support.....	116

## 9. On-Boarding

9.1 On-Boarding.....	119
----------------------	-----

## 10. SD Card Management

10.1 Booting from the SD Cards.....	124
10.2 Creating an IP Office SD Card.....	126

10.3 Viewing the Card Contents.....	128	11.3.2 Shutdown a System Using System Status Application.....	148
10.4 Backing Up to the Backup Folder.....	129	11.3.3 Shutdown a System Using a System Phone..	148
10.4.1 Backup to the Backup Folder Using IP Office Manager.....	129	11.3.4 Shutdown a System Using the AUX Button....	148
10.4.2 Backup to the Backup Folder Using System Status Application.....	129	11.3.5 Shutdown a System Using IP Office Web Manager.....	148
10.4.3 Backup to the Backup Folder Using a System Phone.....	129	11.4 Rebooting a System.....	149
10.4.4 Backup to the Backup Folder Using a IP Office Web Manager.....	130	11.4.1 Reboot a System Using IP Office Manager....	149
10.5 Restoring from the Backup Folder.....	130	11.4.2 Reboot a System Using IP Office Web Manager.....	150
10.5.1 Restoring from the Backup Folder Using IP Office Manager.....	130	11.4.3 Reboot a System Using the Reset Button.....	150
10.5.2 Restoring from the Backup Folder Using System Status Application.....	130	11.4.4 Rebooting a System Using a System Phone..	150
10.5.3 Restoring from the Backup Folder Using a System Phone.....	130	11.5 Changing Components.....	151
10.5.4 Restoring from the Backup Folder Using IP Office Web Manager.....	131	11.5.1 Like for Like Replacement.....	152
10.6 Backing Up to the Optional SD Card.....	133	11.5.2 Higher Capacity Replacement.....	152
10.6.1 Backing Up to the Optional SD Using IP Office Manager.....	133	11.5.3 Lower Capacity Replacement.....	152
10.6.2 Backing Up to the Optional SD Using System Status Application.....	133	11.5.4 Adding a New Component.....	152
10.6.3 Backing Up to the Optional SD Using IP Office Web Manager.....	134	11.5.5 Permanent Removal.....	153
10.6.4 Backing Up to the Optional SD Using a System Phone.....	134	11.5.6 Replacemnt with a Different Type.....	153
10.7 Restoring a Configuration from an Optional Card....	135	11.6 Defaulting the Configuration.....	154
10.7.1 Restoring from the Optional SD Using IP Office Manager.....	135	11.6.1 Defaulting the Configuration Using IP Office Manager.....	154
10.7.2 Restoring from the Optional SD Using a System Phone.....	135	11.6.2 Defaulting the Configuration Using IP Office Web Manager.....	154
10.8 Loading Software from an Optional SD Card.....	136	11.6.3 Defaulting the Configuration Using the Reset Button.....	154
10.8.1 Loading Software from the Optional SD Using IP Office Manager.....	136	11.6.4 Default the Configuration Using a System Phone.....	155
10.8.2 Loading Software from the Optional SD Using a System Phone.....	136	11.6.5 Defaulting the Configuration Using Debug.....	155
10.9 Backing Up to a PC.....	137	11.6.6 Defaulting the Configuration Using Boot Loader.....	156
10.10 Restoring from a PC.....	137	11.7 Defaulting Security Settings.....	157
10.11 Upgrading Card Software.....	139	11.7.1 Defaulting Security Using IP Office Manager..	158
10.12 Memory Card Shutdown/Removal.....	140	11.7.2 Defaulting Security Using IP Office Web Manager.....	158
10.12.1 Shutdown a Card Using IP Office Manager..	140	11.7.3 Defaulting Security using the RS232 Port.....	159
10.12.2 Shutdown a Card Using System Status Application.....	140	11.7.4 Defaulting Security Using the Boot Loader....	160
10.12.3 Shutdown a Card Using IP Office Web Manager.....	141	11.8 Loading a Configuration.....	161
10.12.4 Shutdown a Card Using a System Phone....	141	11.8.1 Creating an Offline Configuration File.....	162
10.13 Memory Card Startup.....	142	11.8.2 Loading a Configuration Using IP Office Manager.....	163
10.13.1 Startup a Card Using IP Office Manager.....	142	11.8.3 Loading a Configuration Using IP Office Web Manager.....	163
10.13.2 Startup a Card Using System Status Application.....	142	11.8.4 Loading a Configuration onto a System SD Card.....	163
10.13.3 Startup a Card Using IP Office Web Manager.....	142	11.9 Upgrading systems.....	164
10.13.4 Startup a Card Using a System Phone.....	142	11.9.1 Upgrade Using the Upgrade Wizard.....	165
		11.9.2 Remote Upgrade the System SD Card Using Manager.....	167
		11.9.3 Upgrading the SD Card Locally.....	167
		11.9.4 Upgrading an SD Card in a PC.....	168
		11.9.5 Upgrading Using IP Office Web Manager.....	169
		11.10 Swapping Extension Users.....	171
		11.11 Out of Building Telephone Installations.....	172
		11.11.1 DS Phones.....	173
		11.11.2 Analog Phone Barrier Box.....	174
		11.11.3 Rack Mounting Barrier Boxes.....	175
		11.12 Using the External Output Port.....	176
		11.12.1 Port Connection.....	176
		11.13 So8 BRI Module.....	177
		11.13.1 Example 1: ISDN Terminal.....	177

## 11. Additional Processes

11.1 Changing an IP Office Basic Edition System to Standard Mode.....	145
11.2 Automating the Change to Standard Mode.....	146
11.3 Switching Off a System.....	147
11.3.1 Shutdown a System Using IP Office Manager.....	147

11.13.2 Example 2: Video Conference.....	178	12.9.11 2420.....	257
11.14 SNMP.....	180	12.9.12 3616.....	258
11.14.1 Installing the IP Office MIB Files.....	181	12.9.13 3620.....	259
11.14.2 Enabling SNMP and Polling Support.....	183	12.9.14 3626.....	260
11.14.3 Enabling SNMP Trap Sending.....	183	12.9.15 3641.....	261
11.15 Reset Button.....	184	12.9.16 3645.....	262
11.16 AUX Button.....	184	12.9.17 3701.....	263
11.17 RS232 Port Maintenance.....	185	12.9.18 3711.....	264
11.18 Erasing the Core Software.....	186	12.9.19 3720.....	265
11.18.1 Erasing Core Software Using the Reset Button.....	186	12.9.20 3725.....	266
11.18.2 Erasing Core Software Using Debug.....	187	12.9.21 3740.....	267
11.18.3 Erasing Core Software Using the Boot Loader.....	188	12.9.22 3749.....	268
11.19 Enabling IP Office Web Manager.....	189	12.9.23 3810.....	269
		12.9.24 3910.....	270
		12.9.25 3920.....	270
		12.9.26 4406.....	271
<b>12. System Components</b>		12.9.27 4412.....	272
12.1 IP500 V2 Control Unit.....	193	12.9.28 4424.....	273
12.2 IP500 V2 System SD Cards.....	196	12.9.29 4601.....	274
12.3 IP500 Base Cards.....	198	12.9.30 4602.....	275
12.3.1 4-Port Expansion Card.....	201	12.9.31 4610.....	276
12.3.2 Analog Phone.....	202	12.9.32 4620.....	277
12.3.3 ATM Combination Card.....	203	12.9.33 4621.....	278
12.3.4 BRI Combination Card.....	206	12.9.34 4625.....	279
12.3.5 Unified Communications Module.....	207	12.9.35 5402.....	280
12.3.6 Digital Station.....	208	12.9.36 5410.....	281
12.3.7 ETR6 Card.....	209	12.9.37 5420.....	282
12.3.8 TCM8 Digital Station.....	211	12.9.38 5601.....	283
12.3.9 VCM.....	212	12.9.39 5602.....	284
12.4 IP500 Trunk Daughter Cards.....	214	12.9.40 5610.....	285
12.4.1 Analog Trunk Card.....	215	12.9.41 5620.....	286
12.4.2 BRI Trunk Cards.....	217	12.9.42 5621.....	287
12.4.3 PRI Trunk Cards.....	218	12.9.43 9504.....	288
12.5 IP500 External Expansion Modules.....	219	12.9.44 9508.....	289
12.5.1 Analog Trunk 16.....	221	12.9.45 9608, 9608G.....	290
12.5.2 BRI So8.....	223	12.9.46 9611G.....	292
12.5.3 Digital Station 16/30.....	225	12.9.47 9620L, 9620C.....	294
12.5.4 Digital Station 16A/30A.....	227	12.9.48 9621G.....	296
12.5.5 Digital Station 16B/30B.....	230	12.9.49 9630G.....	298
12.5.6 Phone 16/30.....	232	12.9.50 9640, 9640G.....	300
12.6 IP400 Expansion Modules.....	234	12.9.51 9641G, 9641GS.....	302
12.6.1 Analog Trunk 16.....	235	12.9.52 9650, 9650C.....	304
12.6.2 Digital Station V2.....	237	12.9.53 Audio Conferencing Unit.....	306
12.6.3 Phone V2.....	239	12.9.54 B100 Series.....	307
12.7 SD Cards.....	241	12.9.55 D100 Series.....	308
12.8 Mounting Kits.....	241	12.9.56 E129.....	309
12.8.1 IP500 Wall Mounting Kits.....	241	12.9.57 ETR 6, ETR 6D.....	310
12.8.2 Barrier Box Rack Mounting Kit.....	241	12.9.58 ETR 18, ETR 18D.....	311
12.9 Phones.....	242	12.9.59 ETR 34D.....	312
12.9.1 1010/1040.....	244	12.9.60 M7100.....	313
12.9.2 1120/1140/1220/1230.....	245	12.9.61 M7100N.....	313
12.9.3 1403.....	246	12.9.62 M7208.....	314
12.9.4 1408.....	247	12.9.63 M7208N.....	314
12.9.5 1416.....	248	12.9.64 M7310.....	315
12.9.6 1603.....	249	12.9.65 M7310N.....	315
12.9.7 1608.....	251	12.9.66 M7324.....	316
12.9.8 1616.....	253	12.9.67 M7324N.....	316
12.9.9 2402.....	255	12.9.68 T7000.....	317
12.9.10 2410.....	256		

12.9.69 T7100.....	317	12.14.16 PHONE (POT) Port.....	365
12.9.70 T7208.....	318	12.14.17 PRI Port.....	366
12.9.71 T7316.....	319	12.14.18 RS232 Port (DTE).....	367
12.9.72 T7316E.....	320	12.15 Licences.....	368
12.9.73 T7406, T7406e.....	321	12.15.1 System Edition Licenses.....	369
12.9.74 T3 Classic.....	322	12.15.2 Upgrade Licenses.....	370
12.9.75 T3 Comfort.....	323	12.15.3 Trunk Licensing.....	371
12.9.76 T3 Compact.....	324	12.15.4 Telephone/Endpoint Licenses.....	372
12.10 Phone Add-Ons.....	325	12.15.5 User Licenses.....	373
12.10.1 201B RIM.....	326	12.15.6 Voicemail Pro Licenses.....	376
12.10.2 4450.....	327	12.15.7 Trial Licenses.....	378
12.10.3 BM32.....	328	12.15.8 CTI Licenses.....	379
12.10.4 DBM32.....	329	12.15.9 Other Licenses.....	379
12.10.5 EU24.....	330	12.16 Hardware/Software Compatibility.....	380
12.10.6 EU24BL.....	331	12.17 Hardware PCS Levels.....	388
12.10.7 KLM Module.....	332	12.18 TAA.....	388
12.10.8 SMB24.....	333		
12.10.9 T3 DSS.....	334	<b>13.Safety Statements</b>	
12.10.10 T7316e KEM.....	335	13.1 Lightning Protection/Hazard Symbols.....	390
12.10.11 XM24.....	336	13.2 Trunk Interface Modules.....	391
12.11 Ancillary Systems.....	337	13.3 Further Information and Product Updates.....	392
12.11.1 Digital Mobility Solution.....	337	13.4 Port Safety Classification.....	392
12.11.2 DECT R4.....	338	13.5 EMC Directive.....	393
12.12 Applications.....	339	13.6 Regulatory Instructions for Use.....	394
12.12.1 IP Office Application Server.....	340	13.6.1 Australia.....	394
12.12.2 ContactStore.....	340	13.6.2 Canada.....	394
12.12.3 IP Office Manager.....	341	13.6.3 China.....	395
12.12.4 Monitor.....	341	13.6.4 Japan.....	396
12.12.5 one-X Portal for IP Office.....	341	13.6.5 European Union.....	396
12.12.6 Avaya Communicator.....	343	13.6.6 New Zealand.....	397
12.12.7 SoftConsole.....	344	13.6.7 FCC Notification.....	398
12.12.8 IP Office Video SoftPhone.....	344	13.6.8 Compliance with FCC Rules.....	400
12.12.9 System Status Application.....	346		
12.12.10 TAPI.....	347	<b>14.Document History</b>	
12.12.11 Voicemail Pro.....	348	Index.....	403
12.12.12 Web Collaboration.....	348		
12.12.13 IP Office Ports.....	348		
12.13 Operating System Summary.....	350		
12.13.1 Windows Support.....	350		
12.13.2 Mac OS Support.....	352		
12.13.3 Linux Support.....	352		
12.13.4 Browser Support.....	352		
12.14 Physical Ports.....	353		
12.14.1 Cables.....	354		
12.14.2 ANALOG Port.....	356		
12.14.3 AUDIO Port.....	356		
12.14.4 BRI Port (So).....	357		
12.14.5 BRI Port (To).....	358		
12.14.6 BST Port (RJ21).....	359		
12.14.7 BST Port (RJ45).....	359		
12.14.8 DC I/P Port.....	360		
12.14.9 DS Ports (RJ45).....	360		
12.14.10 EF Port.....	361		
12.14.11 ETR Port.....	361		
12.14.12 EXPANSION Port.....	362		
12.14.13 EXT O/P Port.....	362		
12.14.14 LAN Port.....	363		
12.14.15 PF Port.....	364		



# Chapter 1.

# System Overview



# 1. System Overview

The Avaya IP Office IP 500 V2 is also known as "IPO IP500 V2 Cntrl Unit", "IP Office IP 500 v2", "IPO IP500 v2", "IP 500 V2", "IP500 V2", "IPO 500v2 System Unit Assembly" or "IP Office 500 v2". Throughout this documentation the term IP500 V2 is used.

This document is intended to assist with the installation of an IP Office system running in IP Office standard mode (IP Office Essential Edition or IP Office Preferred Edition) using an IP500 V2 control unit.

This documentation does not cover installation of IP Office Basic Edition, IP Office Basic Edition - Norstar Mode or IP Office Basic Edition - PARTNER® Mode systems which each have their own separate installation documentation.

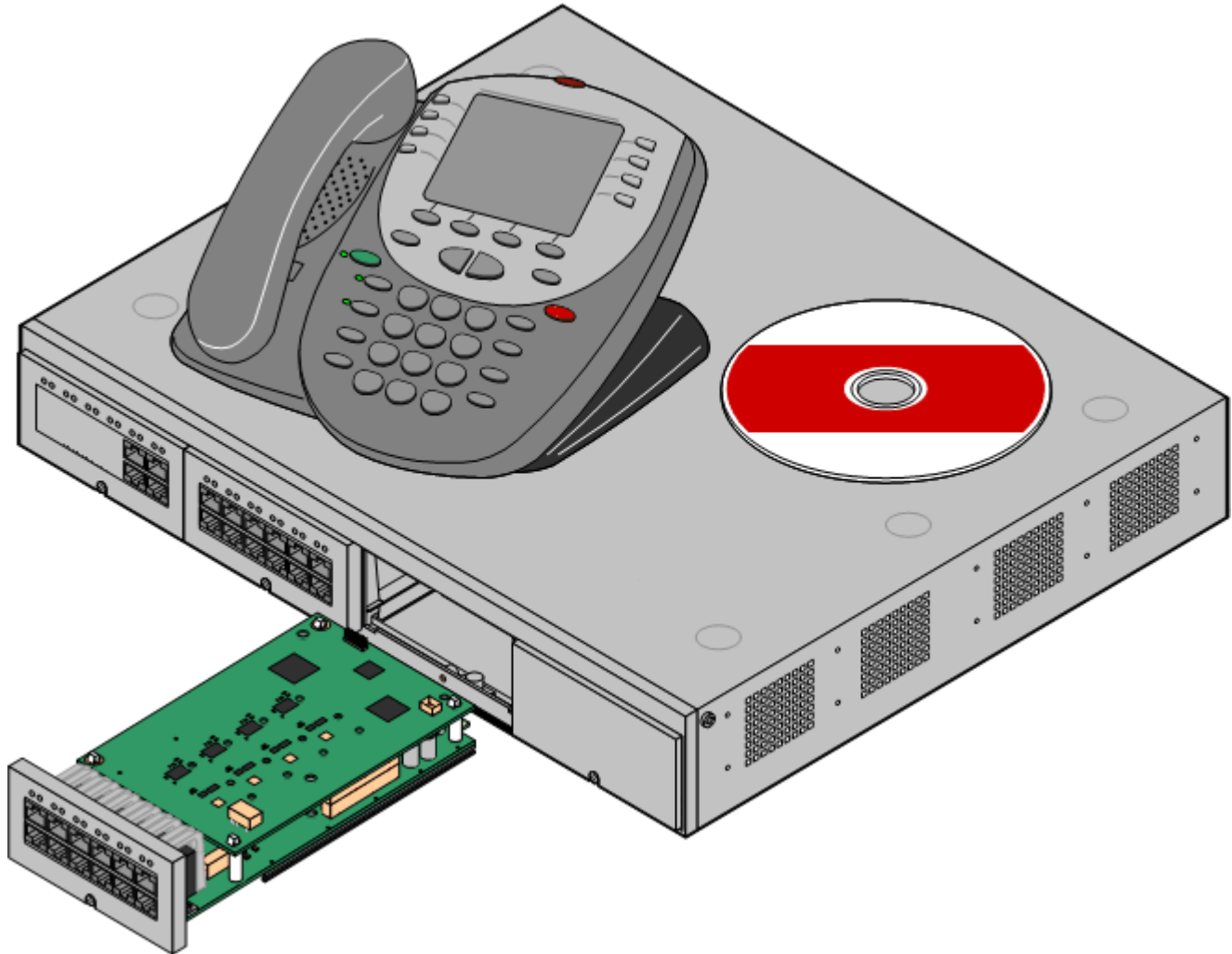

- The IP Office is a converged voice and data communications system. It should therefore only be installed by persons with telephony and IP data network experience.
- Installers must be trained on IP Office systems. Through its [Avaya University](#) (AU), Avaya provides a range of training courses including specific IP Office implementation and installation training. It also provides certification schemes for installers to achieve various levels of IP Office accreditation.
- It is the installer's responsibility to ensure that all installation work is done in accordance with local and national regulations and requirements. It is also their responsibility to accurately establish the customer's requirements before installation and to ensure that the installation meets those requirements.
- You should read and understand this documentation before installation. You should also obtain and read the Avaya Technical Bulletins relevant to recent software and hardware releases to ensure that you are familiar with any changes to the IP Office equipment and software.

---

## 1.1 Additional Documentation

### Additional Documentation

The following components of core system are outside the range of a basic system installation. They are covered by separate installation and configuration documentation. If those components are to be part of the system installation, that documentation should be obtained, read and understood prior to the installation.

- **Avaya IP Office Platform Security Guidelines**
- **one-X Portal for IP Office Installation.**
- **Avaya H323 IP Phone Installation.**
- **Embedded Voicemail Installation.**
- **Voicemail Pro Installation.**
- **Contact Store Installation.**
- **Compact DECT Installation.**
- **IP DECT R4 Installation.**
- **3600 Series Wireless IP Installation.**
- **SoftConsole Installation Manual.**
- **SIP Extension Configuration.**
- **1100/1200 Series Phone Installation.**

- **! IP Office Technical Bulletins**

You must obtain and read the IP Office Technical Bulletin relating to the IP Office software release which intend to install. The bulletin contains important information that may not have been included in this manual. IP Office Technical Bulletins are available from the [Avaya support](http://support.avaya.com) website (<http://support.avaya.com>).

- **! Upgrade Licenses**

Some upgrades may require entry of upgrade licenses. It is still possible to upgrade the system without the necessary licenses, however the system will not provide any telephony functions after the upgrade until the appropriate license is added to the system configuration.

## 1.2 Repair

IP Office systems do not contain any user serviceable or repairable components. If a faulty unit is suspected, the whole unit should be replaced.

IP Office control units should not be opened under any circumstances except the insertion of IP500 base cards.

## 1.3 RoHS

RoHS is a European Union directive for the Removal of Certain Hazardous Substances from Electrical and Electronic Equipment. Similar legislation has been or is being introduced in a number of other countries. Avaya has decided to make its global product range compliant with the requirements of RoHS.

The actions taken vary

- In some cases equipment has been discontinued and is no longer available from Avaya.
- In some cases new manufactured stock has been made RoHS compliant and keeps its existing SAP code.
- In other cases the equipment has been replaced by a new RoHS compliant alternative with new SAP codes.
- The SAP codes within this document are for RoHS compliant equipment unless otherwise stated.

---

## 1.4 IP Office Modes

IP Office systems can run in a number of modes. The following modes are supported by IP500 V2 control units:

### IP Office Standard Modes

The following operating modes are collectively referred to as IP Office standard mode.

- **IP Office Essential Edition**

This is the default mode for an IP500 control unit. For IP Office Release 9.1, IP500 V2 systems run in this mode if an **Essential Edition** license is added to the configuration. Systems without a license will not support any telephony functions.

- **IP Office Preferred Edition**

This mode is similar to IP Office Essential Edition but adds support for the Voicemail Pro application. This mode is enabled by adding a **Preferred Edition (Voicemail Pro)** license to a system already licensed for **Essential Edition**.

### IP Office Basic Edition Modes

The following operating modes are collectively referred to as IP Office basic mode. These modes are supported by IP500 V2 control units only.

- **IP Office Basic Edition**

This is the default operating mode for IP500 V2 control units.

- **IP Office Basic Edition - Norstar Mode**

This mode operates the same as the IP Office Basic Edition mode. This mode is sold in Middle East and North African locales.

- **IP Office Basic Edition - PARTNER® Mode**

This mode operates the same as the IP Office Basic Edition mode. This mode is sold in North American locales.

### Other Modes

- **Server Edition**

This special mode is not covered by this documentation. Refer to the separate Server Edition documentation. An IP500 V2 system can be used in a Server Edition network as an IP500 V2 Expansion System system. Therefore, the hardware compatibility notes for the IP500 V2 control unit in this manual remain applicable for Server Edition usage unless stated otherwise.

- **IP Office™ Platform Select**

This mode enabled additional capacity features on Server Edition systems.

---

## 1.4.1 System SD Cards

IP500 V2 control unit must be fitted with a System SD card. The default mode of the system is determined by the type of System SD card present. By using IP Office Manager and adding licenses the mode of the system can be changed.

The different System SD cards are:

- **IP Office U-Law SD Card**

A system fitted with this type of card defaults to U-Law telephony. For pre-IP Office Release 7.0 software, the system will default to IP Office standard mode. For IP Office Release 7.0+, the system will default to IP Office Basic Edition **Key System** operation. Intended for North American locales.

- **IP Office A-Law SD Card**

A system fitted with this type of card defaults to A-Law telephony. For pre-IP Office Release 7.0 software, the system will default to IP Office standard mode. For IP Office Release 7.0+, the system will default to IP Office Basic Edition **PBX System** operation. Intended for locales outside North America.

- **IP Office Partner Edition SD Card**

A system fitted with this type of card defaults to U-Law telephony and IP Office Basic Edition - PARTNER® Mode **Key System** operation. Supported only in North American locales.

- **IP Office Norstar Edition SD Card**

A system fitted with this type of card defaults to A-Law telephony and IP Office Basic Edition - Norstar Mode **Key System** operation. Supported only in Middle East and North African locales.

## 1.4.2 Overall Capacity

The following table is a summary only. The exact combinations of extension, trunk and user ports also depends on local variations in hardware support. For example, BRI trunks are not supported in North American locales.

		IP Office Basic Edition - PARTNER® Mode	IP Office Basic Edition - Norstar Mode	IP Office Basic Edition	Standard Mode
<b>Extensions</b>	Maximum Extensions	100 <sup>[1]</sup>	100 <sup>[1]</sup>	100 <sup>[1]</sup>	384
<b>Trunks</b>	Maximum Trunks	64	64	64	<sup>[5]</sup>
	- Maximum Analog Trunks	32	32	32	204
	- Maximum BRI Channels <sup>[3]</sup>	-	12	12	32
	- Maximum PRI Channels <sup>[4]</sup>	24	30	30	240
	- Maximum SIP Channels <sup>[2]</sup>	20	20	20	<sup>[5]</sup>
	- Maximum H323 IP Channels	-	-	-	<sup>[5]</sup>

1. 100 Extensions in 3-digit extension numbering mode. 48 extensions in 2-digit extension numbering mode.

- For IP Office Basic Edition modes, the system assumes that the base control unit is always fully populated with up to 32 extensions, either real or phantom or a mix, to which it assigns extension numbers in sequence. It does this before assigning extension numbers to any real extensions on attached external expansion modules up to the system extension limit. If the system extension limit has not been exceeded, any remaining extension numbers are assigned to additional phantom extensions.

2. IP Office Basic Edition mode systems support 3 SIP channels without licenses. Additional channels up to the limit require licenses. IP Office standard mode systems require licenses for all channels. In all modes, voice compression hardware resources are also required for SIP support.

3. IP Office Basic Edition mode systems do not support both BRI and PRI trunks in the same system. They are also restricted to 12 BRI channels regardless of the BRI hardware installed. IP Office standard mode systems support both BRI and PRI trunks in the same system.

4. IP Office Basic Edition mode systems are limited to 1 single-port PRI card.

5. Capacity is dependent on licenses, voice compression resources and available bandwidth.

### 1.4.3 Hardware Support Summary

Note that even where indicated as supported, the availability and support of equipment may still be subject to local restrictions. The table below is a summary for IP Office Release 9.1, refer to [Hardware Software Compatibility](#)<sup>[388]</sup> for a more historical summary and for a listing of supported telephones.

	IP Office Basic Edition modes	IP Office standard modes
<b>IP500 V2 Control Unit</b>	✓	✓
<b>IP500 Base Cards</b>		
<b>IP500 Digital Station Card</b>	✓ 3	✓ 3
<b>IP500 Analog Phone 2/8</b>	✓ 4	✓ 4
<b>IP500 TCM8 Card</b>	✓ 4	✓ 4
<b>IP500 VCM 32/64 Cards</b>	-	✓ 2
<b>IP500 4-Port Expansion</b>	-	✓ 1
<b>IP500 BRI Combo<sup>[2]</sup></b>	-	✓
<b>IP500 ATM Combo<sup>[2]</sup></b>	✓ 2	✓ 2
<b>IP500 ATM Combo V2<sup>[2]</sup></b>	✓ 2	✓ 2
<b>IP500 ETR6<sup>[1][6]</sup></b>	✓ 3	-
<b>Unified Communications Module<sup>[6]</sup></b>	-	✓
<b>Trunk Daughter Cards</b>		
<b>Analog Trunk Card</b>	✓	✓
<b>Analog Trunk Card V2</b>	✓	✓
<b>BRI Trunk Cards<sup>[4]</sup></b>	-	✓
<b>PRI Trunk Card<sup>[4][5]</sup></b>	✓ 1	✓ 4
<b>Expansion Modules</b>		
<b>Number of Modules<sup>[3]</sup></b>	8	12
<b>Digital Station 16/30</b>	✓	✓
<b>Digital Station 16A/30A</b>	✓	✓
<b>Digital Station 16B/30B</b>	✓	✓
<b>Phone 8/16/30</b>	✓	✓
<b>Analog Trunk 16</b>	✓	✓
<b>BRI So8</b>	-	✓
<b>Telephone Types</b>		
<b>ETR Phones (ETR ports)</b>	✓	-
<b>BST Phones (BST ports)</b>	✓	✓
<b>DS Phones (DS ports)</b>	✓	✓
<b>H323 IP Phones (LAN)</b>	-	✓
<b>SIP IP Phones (LAN)</b>	-	✓
<b>DECT R4 (LAN)</b>	-	✓
<b>DECT DMS (BST ports)</b>	✓	✓
<b>Voicemail Types</b>		
<b>Embedded Voicemail</b>	✓	✓
<b>Voicemail Pro</b>	-	✓

1. The ETR6 card is only supported by IP500 V2 systems in IP Office Basic Edition - PARTNER® Mode or IP Office Basic Edition U-Law modes.
2. Only 2 combinations cards are supported in a control unit, regardless of combination card type.
3. External expansion modules can be added so long as the overall limit for extensions and trunks is not exceeded. On IP Office Basic Edition mode systems, a maximum of one Analog Trunk 16 module is supported.
4. IP Office Basic Edition mode systems do not support a mix of BRI and PRI trunks.
5. IP Office Basic Edition mode systems only support a single-port PRI card.



## 1.4.4 Feature Support Summary

The table below is a general summary only. For more specific details refer to the installation documentation for the specific application.

		IP Office Basic Edition			IP Office Essential Edition	IP Office Preferred Edition
		PARTNER Mode	Norstar Mode	Quick Mode		
Admin Applications	Phone Based Admin	✓	✓	✓	-	-
	IP Office Web Manager	✓	✓	✓	✓	✓
	IP Office Manager	✓	✓	✓	✓	✓
	Monitor (System Monitor)	✓	✓	✓	✓	✓
	System Status Application	✓	✓	✓	✓	✓
Applications	one-X Portal for IP Office	-	-	-	-	✓
	one-X Mobile	-	-	-	-	✓
	Avaya Communicator	-	-	-	-	✓
	SoftConsole	-	-	-	✓	✓
	TAPI (1st Party)	-	-	-	✓	✓
	TAPI (3rd Party)	-	-	-	✓	✓
	Voicemail Pro	-	-	-	-	✓
	Contact Recorder for IP Office	-	-	-	-	✓
Locales		Canada, Mexico, United States.	Bahrain, Egypt, Kuwait, Morocco, Oman, Pakistan, Qatar, Saudi Arabia, South Africa, Turkey, United Arab Emirates.	Argentina, Australia, Bahrain, Belgium, Brazil, Canada, Chile, China, Colombia, Czech, Denmark, Egypt, Finland, France, Germany, Greece, Hong Kong, Hungary, Iceland, India, Ireland, Italy, Japan, Korea, Kuwait, Malaysia, Mexico, Morocco, Netherlands, New Zealand, Norway, Oman, Pakistan, Peru, Philippines, Poland, Portugal, Qatar, Russia, Saudi Arabia, Singapore, South Africa, Spain, Sweden, Switzerland, Taiwan, Turkey, United Arab Emirates, United Kingdom, United States, Venezuela.		
Voicemail Languages	Embedded Voicemail	<ul style="list-style-type: none"> <li>Arabic, Chinese-Mandarin, Chinese-Cantonese, Danish, Dutch, English-UK, English-US, Finnish, French, French-Canadian, German, Italian, Korean, Norwegian, Portuguese, Portuguese Brazilian, Russian, Swedish, Spanish, Spanish-Latin, Spanish-Argentinean.</li> </ul>				
	Voicemail Pro	-	-	-	-	As above plus: Hungarian, Greek, Polish. Minus: Arabic.

---

## 1.5 The Control Unit

The base of any IP Office system is the control unit. It stores the system configuration and controls the system operation. Each control unit can be customized by inserting various [base card](#)<sup>[21]</sup> onto which [trunk daughter cards](#)<sup>[24]</sup> can also be added. [External expansion modules](#)<sup>[25]</sup> can also be connected to add additional extension and trunk ports.

IP Office Release 9.1 supports the following IP Office control units. Other previous types of IP Office control units are not supported by IP Office Release 9.1 and are not covered by this documentation.

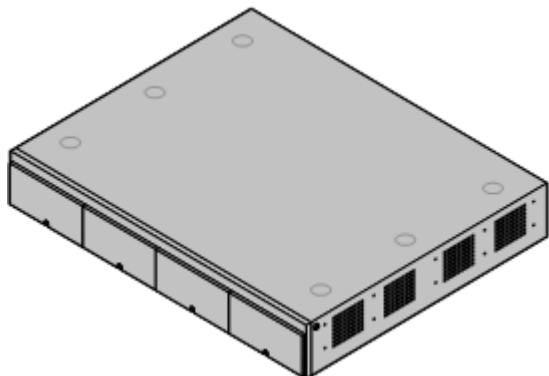

- **[IP500 V2 Control Unit](#)**<sup>[193]</sup>

This control unit has four front slots for IP500 base cards. It has an internal power supply unit and uses a mandatory System SD card. It includes a 2 port ethernet LAN switch (layer 3 managed) on the rear.

- The type of System SD card fitted to the system determines its default [operation mode](#)<sup>[13]</sup> of the system. The possible modes are listed below. Some modes require the addition of licenses:

- **IP Office Basic Edition**
- **IP Office Basic Edition - PARTNER® Mode**
- **IP Office Basic Edition - Norstar Mode**
- **IP Office Essential Edition**
- **IP Office Preferred Edition**
- **Server Edition**

## 1.6 IP500 V2 System Components

The following are the typical components of a system based on an IP500 V2 control unit.

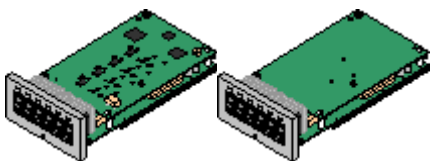
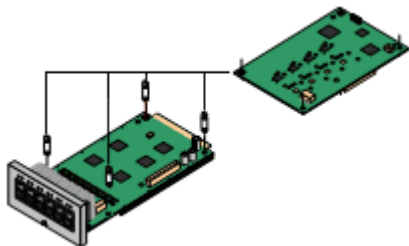
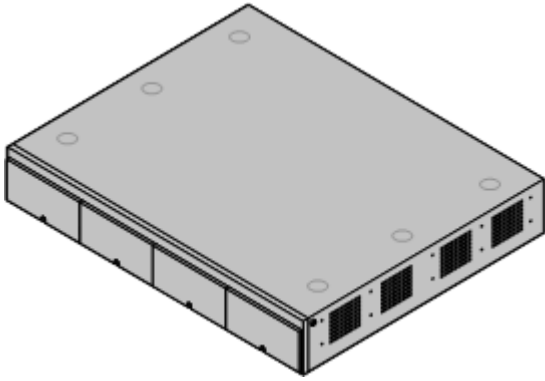

VK00nDd15SDvXoxkw9cR9x\_jOXr\_AWz9

- [IP Office IP500 V2 System Unit](#) <sup>[193]</sup>  
The control unit holds the main configuration and performs the routing and switching for telephone calls and data traffic. Each control unit includes 4 slots for optional base cards to support trunk and phone extension ports.
-  [Avaya SD Card](#) <sup>[38]</sup>  
This uniquely numbered dongle is used to validate license keys entered into the system's configuration to enable features. A dongle is mandatory for correct system operation even if no licensed features are being used. IP500 V2 control units use an Avaya SD card which is slotted into the rear of the control unit. This card also provides Embedded Voicemail support and storage for system software files.
- [IP500 Base Cards](#) <sup>[21]</sup>  
The IP500 V2 control unit has slots for up to 4 IP500 base cards. These can be used to add ports for analog extensions, digital extensions, voice compression channels and other resources.
  - [IP500 Digital Station Base Card](#) <sup>[208]</sup>
  - [IP500 Analog Phone Base Card](#) <sup>[202]</sup>
  - [IP500 VCM Base Card](#) <sup>[212]</sup>
  - [IP500 4-Port Expansion Base Card](#) <sup>[201]</sup>
  - [IP500 TCM8 Base Card](#) <sup>[211]</sup>
  - [IP500 ETR6 Base Card](#) <sup>[209]</sup>
  - [Unified Communications Module](#) <sup>[207]</sup>
- [IP500 Trunk Daughter Cards](#) <sup>[24]</sup>  
Many of the IP500 base cards can be fitted with an IP500 daughter card in order to support various types of trunk connections.
  - [IP500 Analog Trunk Card](#) <sup>[215]</sup>
  - [IP500 Analog Trunk Card V2](#) <sup>[215]</sup>
  - [IP500 BRI Trunk Card](#) <sup>[217]</sup>
  - [IP500 PRI Trunk Card](#) <sup>[218]</sup>
- [IP500 Combination Cards](#) <sup>[21]</sup>  
These card are pre-paired base and daughter cards. They provide 6 digital station ports, 2 analog phone ports, 10 voice compression channels and either 4 analog trunk ports or 4 BRI channels (2 ports). The trunk daughter card cannot be removed or replaced with another type.
  - [IP500 BRI Combination Card](#) <sup>[206]</sup>
  - [IP500 ATM Combination Card](#) <sup>[203]</sup>
  - [IP500 ATM Combination Card V2](#) <sup>[203]</sup>
- [License Keys](#) <sup>[37]</sup>  
Various features and applications require a license key to be entered into the system's configuration. Each key is a 32-character text string unique to the feature being activated and the serial number of the System SD card installed in the system.

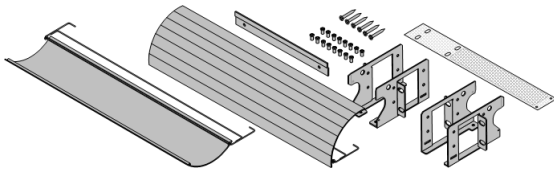
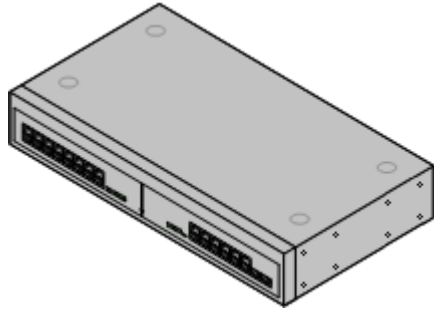

- **[IP500 External Expansion Modules](#)**<sup>[25]</sup>

Additional ports can be added using a number of IP500 external expansion modules.

- Systems running in IP Office Basic Edition modes support up to 8 external expansion modules so long as the system extensions limit is not exceeded.
- Systems running in IP Office standard modes support 8 external expansion modules or 12 if the control unit is fitted with an IP500 4-Port Expansion Base Card.

- **[Power Supplies](#)**<sup>[30]</sup>

The IP500 control unit has an internal power supply unit. Each external expansion module is supplied with an external power supply unit. Additional power supply units may also be required for IP phones and some phone add-ons.

- **[Power Cords](#)**<sup>[31]</sup>

Depending on the locale, different power cords need to be ordered for each control unit, external expansion module and any phones or devices using external power supply units.

- **[Cables](#)**<sup>[33]</sup>

The system is designed primarily for connection to a structured cabling system using CAT3 UTP cabling. This approach allows telephone and data traffic to share the same wiring infrastructure and simplifies equipment moves.

- **[Mounting Kits](#)**<sup>[37]</sup>

The control unit can be used free-standing, with external expansion modules stacked above it. With optional rack mounting kits, the control unit and external expansion modules can also be rack mounted. Alternatively with an optional wall mounting kit the IP500 control unit can be wall mounted. IP500 external expansion modules can also be wall mounted.

- **[Surge Protectors and Barrier Boxes](#)**<sup>[36]</sup>

Where the installation includes extensions in other buildings additional protective equipment is required. This equipment may also be required in areas where the lightning risk is high.

- **[Phones](#)**<sup>[39]</sup>

IP Office systems support a variety of Avaya digital and IP phones plus analog phones.

- **[Application DVDs](#)**<sup>[44]</sup>

The IP Office applications can be ordered on a number of DVDs. In addition they can be downloaded from the IP Office section of the [Avaya support](http://support.avaya.com) web site (<http://support.avaya.com>).

## 1.7 Control Unit Cards

### 1.7.1 IP500 Base Cards

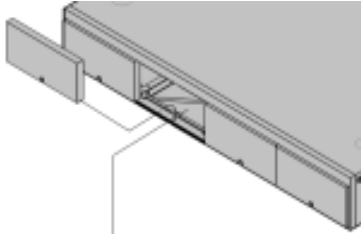

The IP500 V2 control unit has 4 slots for the insertion of IP500 base cards. The slots are numbered 1 to 4 from left to right. Normally they can be used in any order, however if the capacity for a particular type of card is exceeded, the card in the rightmost slot will be disabled.

Each base card includes an integral front panel with ports for cable connections. Typically the first 8 ports on the left are for connection of extension devices. The 4 ports on the left are used for connection of trunks if a [trunk daughter card](#) <sup>[24]</sup> is added to the base card.

#### [IP500 Digital Station Base Card](#) <sup>[208]</sup>



This card provides 8 DS (digital station) ports for the connection of Avaya digital phones.

- The card can be fitted with an [IP500 trunk daughter card](#) <sup>[24]</sup> which uses the base card ports for trunk connection.
- **Maximum:** 3 per control unit.
  - 4400 Series phones (4406D, 4412D and 4424D) are not supported on this card. They are supported on external expansion module DS ports.
  - Connections for 4100, 7400, M-Series and T-Series phones use the IP500 TCM8 Digital Station card.

#### [IP500 Analog Phone Base Card](#) <sup>[202]</sup>

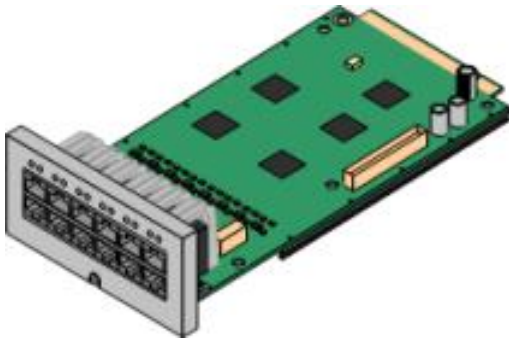

The card is available in two variants, supporting either 2 or 8 analog phone ports.

- The card can be fitted with an [IP500 trunk daughter card](#) <sup>[24]</sup> which uses the base card ports for trunk connection.
- **Maximum:** 4 per control unit.
  - The analog phone ports do not include a ringing capacitor. Where this is a requirement, connection should be via a Master socket containing ringing capacitors.
  - If fitted with an IP500 Analog Trunk daughter card, during power failure phone port 8 is connected to analog trunk port 12.

#### [IP500 TCM8 Digital Station Card](#) <sup>[211]</sup>

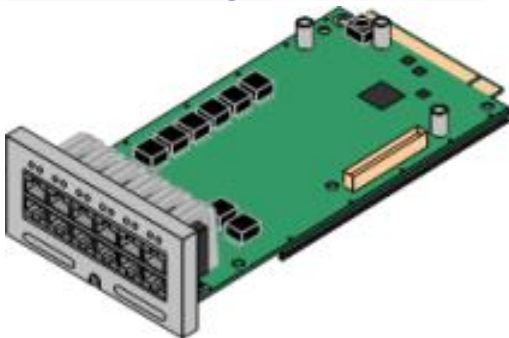

This card provides 8 BST (digital station) ports for the connection of Avaya 4100, 7400, M-Series and T-Series phones.

- The card can be fitted with an [IP500 trunk daughter card](#) <sup>[24]</sup> which uses the base card ports for trunk connection.
- **Maximum:** 4 per control unit per IP500 V2 control unit. Not supported by IP500 control units.

#### [IP500 VCM Base Card](#) <sup>[212]</sup>

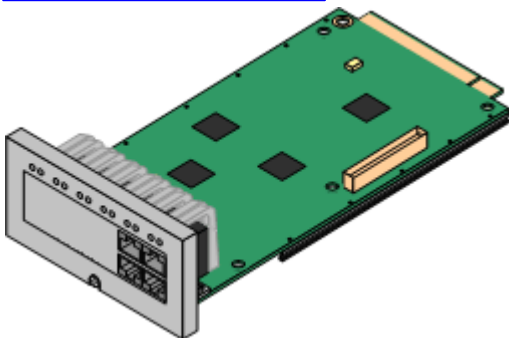

This card is available in variants supporting either 32 or 64 voice compression channels for use with VoIP calls.

- The card can be fitted with an [IP500 trunk daughter card](#) <sup>[24]</sup> which uses the base card ports for trunk connection.
- **Maximum:** 2 per control unit.

## IP500 4-Port Expansion Base Card <sup>201</sup>

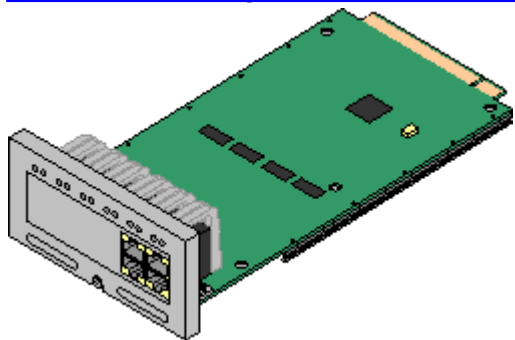

This card adds an additional 4 expansion ports for external expansion modules. The card is supplied with four 2m yellow interconnect cables.

- This card does not accept any IP500 trunk daughter card.
- **Maximum:** 1 per control unit (Right-hand slot 4 only).
- **Supported Expansion Modules:** The following external expansion modules are supported:
  - IP500 Analogue Trunk Module
  - IP500 Digital Station Module A
  - IP500 BRI So Module
  - IP500 Digital Station Module B
  - IP500 Digital Station Module
  - IP500 Phone Module

## IP500 BRI Combination Card <sup>206</sup>

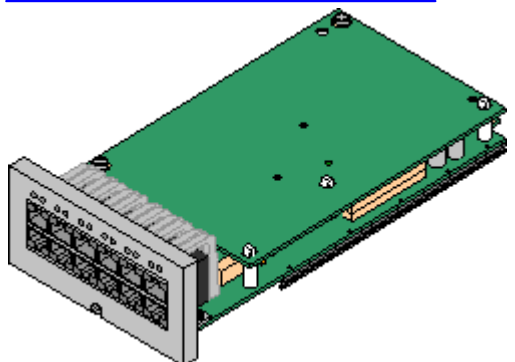

This card provides 6 digital station ports (1-6), 2 analog extension ports (7-8) and 2 BRI trunk ports (9-10, 4 channels). The card also includes 10 voice compression channels.

- **Maximum:** 2 combination cards per IP500 V2 control unit, regardless of type.
  - IP500 Combination cards are pre-fitted with a trunk daughter card which cannot be removed or changed for another type/ capacity trunk daughter card.
  - IP Office Basic Edition - Norstar Mode and IP Office Basic Edition systems are limited to a maximum of 12 BRI channels using BRI Combination and or BRI trunk daughter cards.

## IP500 ATM Combination Card/IP500 ATM Combination Card V2 <sup>203</sup>

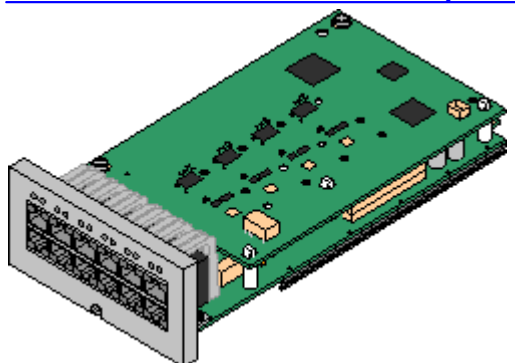

This card provides 6 digital station ports (1-6), 2 analog extension ports (7-8) and 4 analog trunk ports (9-12). The card also includes 10 voice compression channels.

- **Maximum:** 2 combination cards per IP500 V2 control unit, regardless of type.
  - IP500 Combination cards are pre-fitted with a trunk daughter card which cannot be removed or changed for another type/ capacity trunk daughter card.
  - The analog phone ports do not include a ringing capacitor. Where this is a requirement, connection should be via a Master socket containing ringing capacitors.
  - If fitted with an IP500 Analog Trunk daughter card, during power failure phone port 8 is connected to analog trunk port 12.

## IP500 ETR6 Base Card <sup>209</sup>

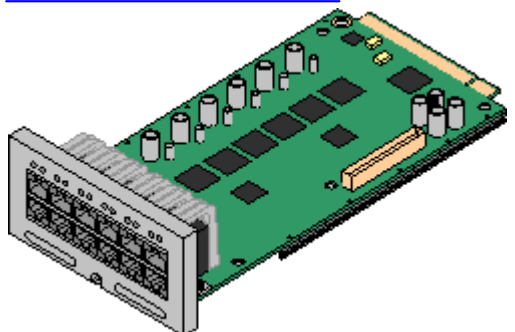

This card is only supported in an IP500 V2 control unit running in IP Office Basic Edition - PARTNER® Mode or IP Office Basic Edition. It provides 6 ETR ports for connection of ETR phones. 2 Analog extension ports are also provided for emergency use only with an analog trunk card.

- The card can be fitted with an IP500 trunk daughter card which uses the base card ports for trunk connection.
- **Maximum:** 3 per IP500 V2 control unit.
- The analog phone ports do not include a ringing capacitor. Where this is a requirement, connection should be via a Master socket containing ringing capacitors.
- If fitted with an IP500 Analog Trunk daughter card, during power failure phone ports 7 and 8 are connected to analog trunk port 12. However during normal operation analog phone ports 7 and 8 are not useable.

## Unified Communications Module <sup>207</sup>



This card acts as an embedded Linux server for the one-X Portal for IP Office and/or Voicemail Pro applications.



## 1.7.2 IP500 Trunk Cards

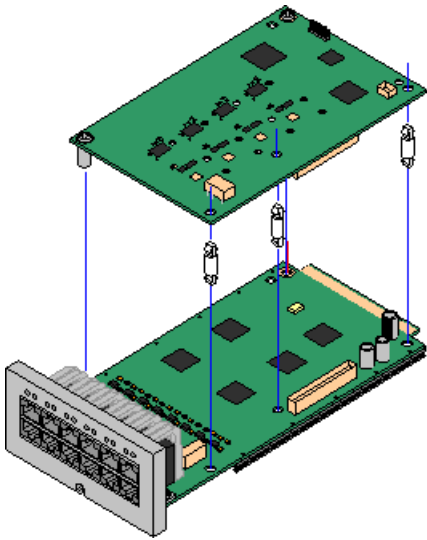

Many [IP500 base cards](#) <sup>[214]</sup> can be fitted with an IP500 trunk daughter cards to support the connection of trunks to the base card.

Each daughter card is supplied with the stand off pillars required for installation and a label to identify the daughter cards presence on the front of the base card after installation.

- IP500 Combination cards are pre-fitted with a trunk daughter card which cannot be removed or changed for another type/ capacity trunk daughter card.

### [IP500 Analog Trunk Card/IP500 Analog Trunk Card V2](#) <sup>[215]</sup>

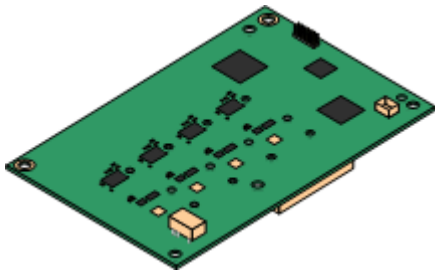

These cards allow the base card to support 4 analog loop-start trunks.

- The analog phone ports do not include a ringing capacitor. Where this is a requirement, connection should be via a Master socket containing ringing capacitors.
- If fitted with an IP500 Analog Trunk daughter card, during power failure phone port 8 is connected to analog trunk port 12.
- **Maximum:** 4 per control unit. The IP500 Analog Trunk Card V2 is only supported in the IP500 V2.

### [IP500 PRI-U Trunk Card](#) <sup>[218]</sup>

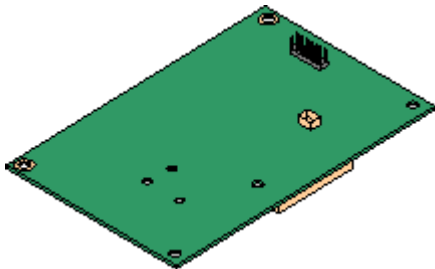

This card allows the base card to support up to 2 PRI trunk connections. The card is available in single and dual port variants. The card can be configured for E1 PRI, T1 robbed bit, T1 PRI or E1R2 PRI trunks. A T1(J) variant for use in Japan is also available.

- **Maximum:** 4 per control unit.
- The IP Office system supports 8 unlicensed B-channels on each IP500 PRI-U port fitted. Additional B-channels, up to the capacity of ports installed and PRI mode selected require [IP500 Universal PRI \(Additional Channels\)](#) <sup>[374]</sup> licenses added to the configuration. These additional channels consume the licenses based on which additional channels are configured as in-service from port 9 of slot 1 upwards. D-channels are not affected by licensing.

### [IP500 BRI Trunk Card](#) <sup>[217]</sup>

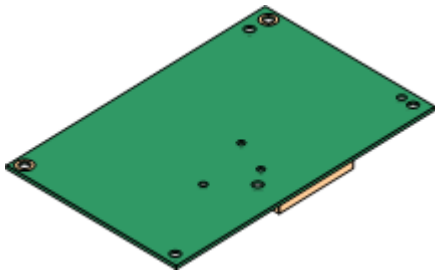

This card allows the base card to support up to 4 BRI trunk connections, each trunk providing 2B+D digital channels. The card is available in 2 port (4 channels) and 4 port (8 channels) variants.

- **Maximum:** 4 per control unit.
- **S-Bus Connection:** The card can be switched from To trunk mode to So mode. This mode requires additional terminating resistors and an ISDN crossover cable connection, see [BRI Port \(So\)](#) <sup>[357]</sup>.
- IP Office Basic Edition - Norstar Mode and IP Office Basic Edition systems are limited to a maximum of 12 BRI channels using BRI Combination and or BRI trunk daughter cards.



## 1.8 External Expansion Modules

These modules can be used to add additional ports to an IP Office systems. The number of external expansion modules supported depends on the control unit type. Each module uses an external [power supply unit](#)<sup>[30]</sup> supplied with the module. A locale specific [power cord](#)<sup>[31]</sup> for the PSU must be ordered separately.

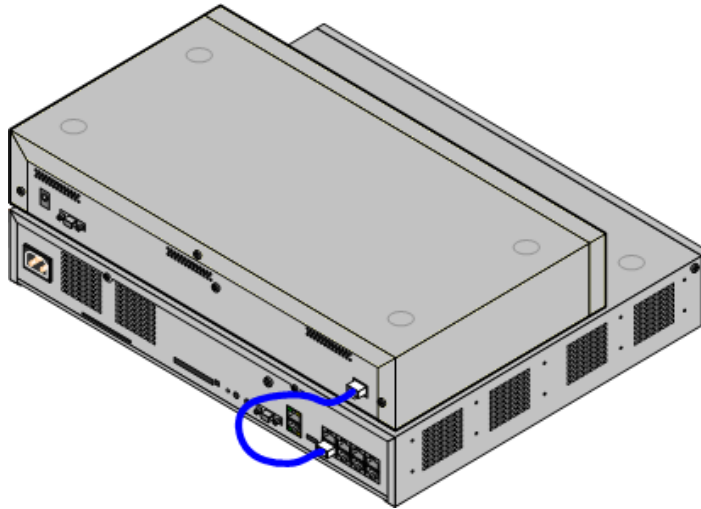

IP500 System with External Expansion Module

- Systems running in IP Office Basic Edition modes support up to 8 external expansion modules so long as the system extensions limit is not exceeded.
- Systems running in IP Office standard modes support 8 external expansion modules or 12 if the control unit is fitted with an IP500 4-Port Expansion Base Card.
  - Each external expansion module is supplied with a blue 1 meter (3'3") expansion interconnect cable. This cable must be used when connecting to expansion ports on the rear of a control unit.
  - When connecting to expansion ports on an IP500 4-Port Expansion card, a yellow 2 meter (6'6") expansion interconnect cable can be used in place of the standard blue cable. 4 Yellow cables are supplied with the IP500 4-Port Expansion card.

### IP500 External Expansion Modules

Expansion modules include an external power supply unit (PSU) and a 1m blue interconnect cable. They do not include a locale specific power cord for the external PSU or any phone extension cables.

Variant	Country	SAP Code
<b>Digital Phones (Non-IP)</b>		
<a href="#">IPO 500 Digital Station 16</a> <sup>[225]</sup>	All	700449499
<a href="#">IPO 500 Digital Station 30</a> <sup>[225]</sup>	All	700426216
<a href="#">IPO 500 Digital Station 16A (RJ21)</a> <sup>[227]</sup>	All	700500699
<a href="#">IPO 500 Digital Station 30A (RJ21)</a> <sup>[230]</sup>	All	700500698
<a href="#">IPO 500 Digital Station 16B</a> <sup>[230]</sup>	All	700501585
<a href="#">IPO 500 Digital Station 30B</a> <sup>[230]</sup>	All	700501586
<b>Analog Phones</b>		
<a href="#">IPO 500 Phone 16</a> <sup>[232]</sup>	All	700449507
<a href="#">IPO 500 Phone 30</a> <sup>[232]</sup>	All	700426224
<b>Others</b>		
<a href="#">IPO 500 Analog Trunk 16</a> <sup>[227]</sup>	US	700449473
<a href="#">IPO 500 BRI So8</a> <sup>[223]</sup>	All	700449515

## 1.8.1 IP500 External Expansion Modules

The following IP500 external expansion modules are supported by IP Office Release 9.1. Each module uses an external [power supply unit](#) [30] supplied with the module. A locale specific [power cord](#) [31] for the PSU must be ordered separately.

The external module can be stacked on top of the control unit. They can also be wall or rack mounted using one of the [IP Office mounting kits](#) [24].

- Systems running in IP Office Basic Edition modes support up to 8 external expansion modules so long as the system extensions limit is not exceeded.
- Systems running in IP Office standard modes support 8 external expansion modules or 12 if the control unit is fitted with an IP500 4-Port Expansion Base Card.

- **[IP500 Digital Station Module](#)** [225]

Provides, depending on variant, an additional 16 or 30 RJ45 [DS](#) [360] ports for supported [Avaya DS digital phones](#) [39].

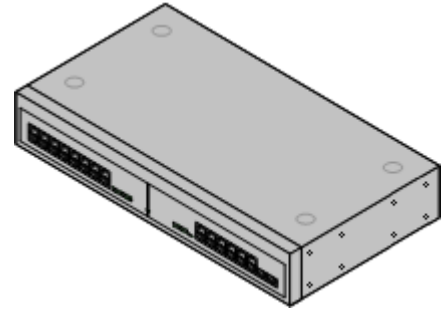

- **[IP500 Digital Station A Module](#)** [227]

Provides, depending on variant, RJ21 ports for connection of an additional 16 or 30 [Avaya BST digital phones](#) [39]. Supported by IP500 V2 only.

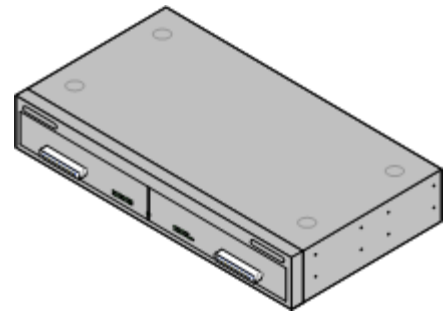

- **[IP500 Digital Station B Module](#)** [230]

Provides, depending on variant, an additional 16 or 30 RJ45 ports. These can be used as either [DS](#) [360] ports for supported [Avaya DS digital phones](#) [39] or [BST](#) [350] ports for supported [Avaya BST digital phones](#) [39]. However, the module can only support one port type at any time.

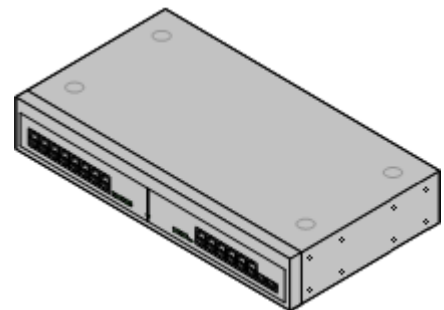

- **[IP500 Phone Module](#)** [232]

Provides, depending on variant, an additional 16 or 30 [PHONE](#) [365] ports for connecting analog phones.

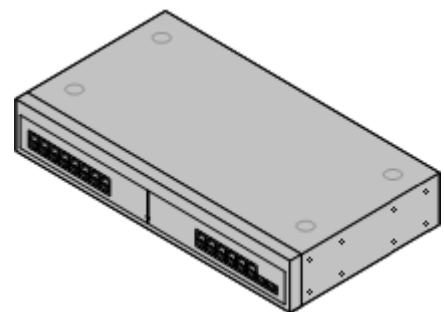

- **IP500 BRI So8 Module** <sup>[223]</sup>

Provides 8 ETSI [BRI-So ports](#) <sup>[357]</sup> for the connection of ISDN devices. This unit is not intended to support BRI trunks.

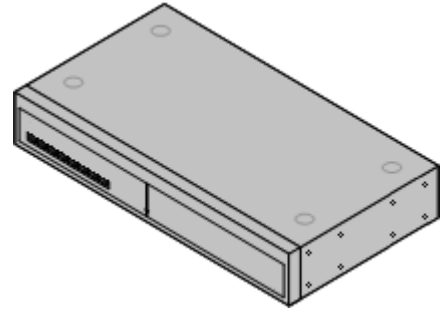

- **IP500 Analog Trunk Module** <sup>[221]</sup>

Provides an additional 16 [ANALOG](#) <sup>[356]</sup> ports for connection of analog trunks. Supports both loop-start and ground-start trunks.

- Use with ground start trunks requires that the trunk module and the IP Office control unit are grounded.
- In IP Office Basic Edition - PARTNER® Mode, IP Office Basic Edition - Norstar Mode and IP Office Basic Editions, only 1 Analog Trunk module is supported.

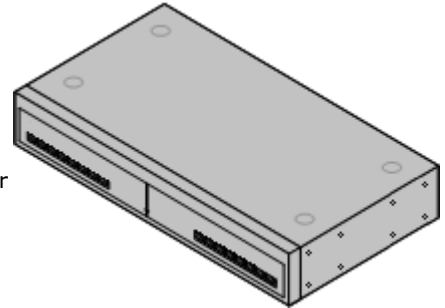

## 1.8.2 IP400 External Expansion Modules

The following IP400 external expansion modules are supported by IP Office Release 9.1 and can be used with IP500 V2 control units. Each module uses an external [power supply unit](#) <sup>[30]</sup> supplied with the module. A locale specific [power cord](#) <sup>[31]</sup> for the PSU must be ordered separately.

If being rack mounted these units use the IP400 rack mounting kit. If being rack mounted, these units use the IPO IP500 RACK MNTG KIT. They cannot be wall mounted.

- **[IP400 Analog Trunk Module \(ATM16\)](#)** <sup>[233]</sup>  
Provides an additional 16 [ANALOG](#) <sup>[350]</sup> ports for connection of analog trunks. Supports both loop-start and ground-start trunks.
  - Available in a number of variants for different locales.
  - Use with ground start trunks requires that the trunk module and the IP Office control unit are grounded.
- **[IP400 Digital Station Module V2](#)** <sup>[237]</sup>  
Provides, depending on variant, an additional 16 or 30 [DS](#) <sup>[360]</sup> ports for supported [Avaya digital phones](#) <sup>[39]</sup>. Supersedes the previous Digital Station module.
- **[IP400 Phone Module V2](#)** <sup>[239]</sup>  
Provides, depending on variant, an additional 8, 16 or 30 [PHONE](#) <sup>[360]</sup> ports for analog phones. Supersedes the previous Phone module. With IP Office 3.1, the Phone V2 supports a wider range of message waiting indication (MWI) options than Phone V1 modules.

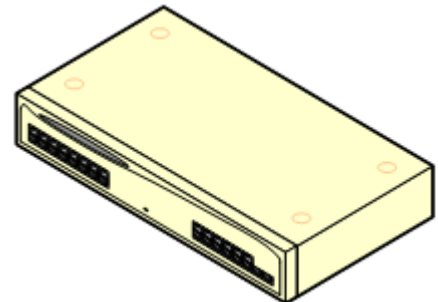
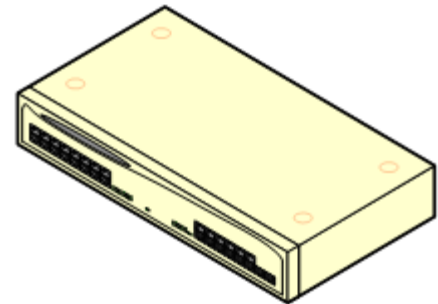
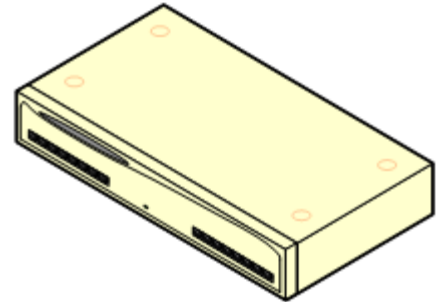

### 1.8.3 Connecting External Expansion Modules

The integral expansion ports on a control unit are located on the rear of the unit. For IP500 V2 control units, an additional 4 expansion ports can be added to the front of the control unit by installing an IP500 4-Port Expansion card.

- Each external expansion module is supplied with a blue 1 meter (3'3") expansion interconnect cable. This cable must be used when connecting to expansion ports on the rear of a control unit.
- When connecting to expansion ports on an IP500 4-Port Expansion card, a yellow 2 meter (6'6") expansion interconnect cable can be used in place of the standard blue cable. 4 Yellow cables are supplied with the IP500 4-Port Expansion card.

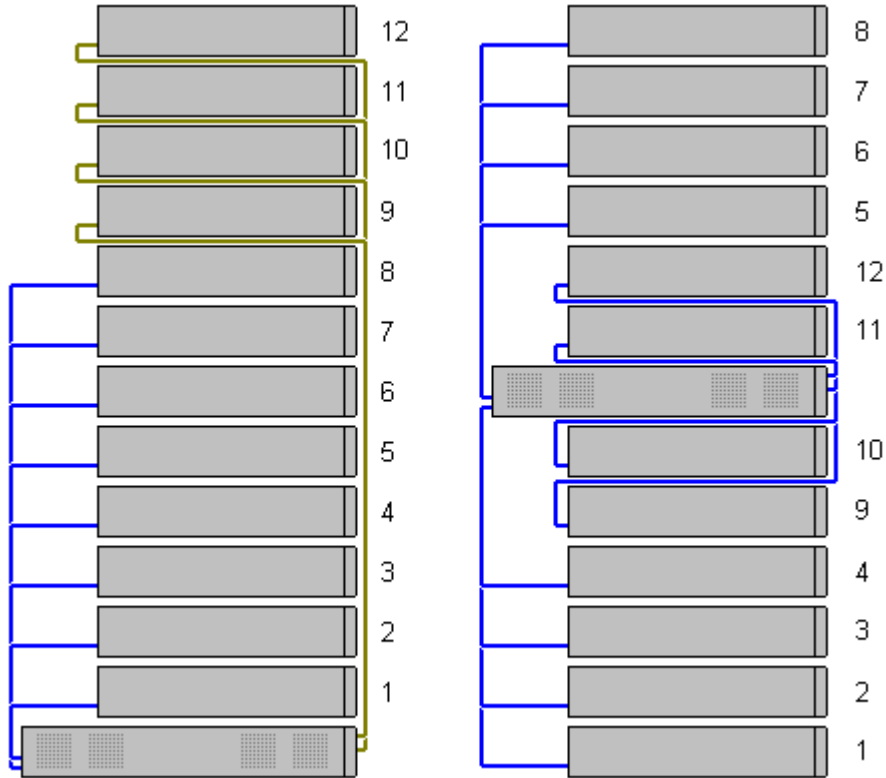

## 1.9 Power Supplies and Cables

All IP Office control units and external expansion modules either have an internal power supply unit or are supplied with an external power supply unit.

### 1.9.1 Power Supplies

IP500 V2 control units have an internal power supply unit and so only require a suitable [locale specific power cord](#)<sup>[31]</sup> and a power outlet that includes a switch. Note that if the power cord includes an earth lead, the power outlet must be connected to a protective earth.

External expansion modules are all supplied with an external power supply unit (PSU). These PSUs include an integral 1.5 meter lead for connection to the control unit or expansion module. A [power cord](#)<sup>[31]</sup> for connection from the PSU to the power outlet is not included as this varies by locale. The appropriate power cord must be ordered separately or sourced locally.

Additional power supply units are required for 4450, EU24, XM24 and T3 DSS add-on modules and may also be required for Avaya IP phones.

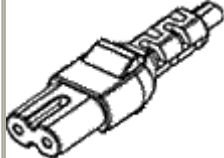
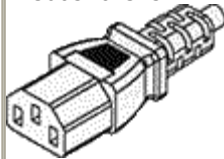
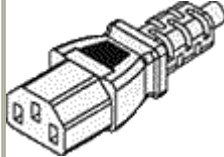
Area	Type	Used on:	Connector Type
IP Office Control Units and External Expansion Modules	40W PSU	Analog, Digital Station V1, Phone V1.	IEC60320 C7 
	60W Earthed PSU	IP500 Phone 30, IP500 Digital Station 30, IP500 Digital Station 16A, IP500 Digital Station 30A.	IEC60320 C13 
IP Phones and Phone Add-Ons	1151D1	All phones with XM24 Phone add-ons. All phones with EU24/EU24BL Phone add-ons unless using Class 3 PoE.	IEC60320 C13 
	1151D2	4600 and 56000 Series IP Phones when not using a PoE.	
	1600PWR 5V	Plug-top PSU used with 1600 Series phones on IP Office when not being power using PoE.	Various country variants.

- The 1151D2 is the same as the 1151D1 except that it includes a backup battery that is charged during normal operation. This can provide typically 15 minutes backup at maximum load (20 Watts) and up to 8 hours at light load (2 Watts).
- Avaya IP phones can use IEEE 802.3af Power over Ethernet (PoE) power supplies. Refer to the IP Office IP Phone Installation Manual for full details.

### 1.9.2 Power Supply Cords

Each control unit and expansion module requires a switched power outlet socket rated at 110-240V ac, 50-60Hz. Connection from that power outlet socket requires an appropriate locale specific power cord which is not supplied with the unit and must be ordered separately. Note that if the power cord includes an earth lead, the power outlet must be connected to a protective earth.

Power cords must not be attached to the building surface or run through walls, ceilings, floors and similar openings. Installation measures must be taken to prevent physical damage to the power supply cord, including proper routing of the power supply cord and provision of a socket outlet near the fixed equipment or positioning of the equipment near a socket outlet.

For locales not detailed below an appropriate power cord must be obtained locally.

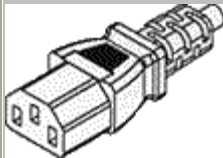
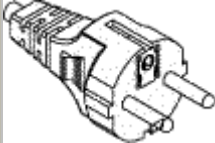
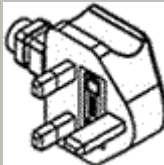
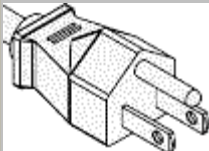
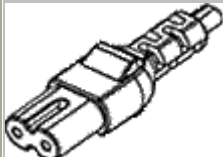
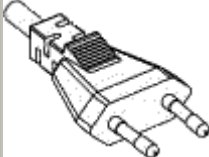
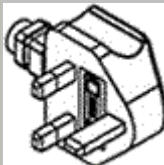
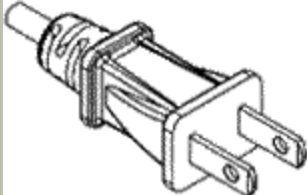
Power Cord Type	Power Outlet Plug Type	Locales	SAP Codes
<b>Earthed Power Cords (IEC60320 C13)</b>  <b>Control Units</b> <ul style="list-style-type: none"> <li>IP500 V2.</li> </ul> <b>IP500 External Expansion Modules</b> <ul style="list-style-type: none"> <li>BRI So8.</li> <li>Digital Station 16/30.</li> <li>Phone 16/30.</li> </ul>	<b>CEE7/7 (Schuko)</b> 	Europe and South Africa.	700289762
	<b>BS1363</b> 	Czech Republic, Ireland, United Kingdom.	700289747
	<b>NEMA5-15P / CS22.2 No.42</b> 	North, Central and South America.	700289770
<b>Unearthed Power Cord (IEC60320 C7)</b>  <b>IP500 External Expansion Modules</b> <ul style="list-style-type: none"> <li>Analog Trunk 16.</li> </ul>	<b>CEE7/16 (Europlug)</b> 	Europe and South Africa.	700213382
	<b>BS1363</b> 	Czech Republic, Ireland, United Kingdom.	700213374
	<b>NEMA1-15</b> 	North, Central and South America.	700213390
		Korea.	700254519

---

### 1.9.3 Power Supply Backup

The use of an Uninterrupted Power Supply (UPS) with any telephone system is strongly recommended. Even at sites that rarely lose electrical power, that power may occasionally have to be switched off for maintenance of other equipment. In addition, most UPSs also provide an element of power conditioning, reducing spikes and surges.

The capacity of UPS systems and the total equipment load the UPS is expected to support are usually quoted in VA. Where equipment load is quoted in Watts, multiply by 1.4 to get the VA load.

The calculation of how much UPS capacity is required depends on several choices.

- **What equipment to place on the UPS?**

Remember to include server PCs such as the voicemail. It is recommended that the total load on a new UPS is never greater than 75% capacity, thus allowing for future equipment.

- **How many minutes of UPS support is required?**

Actual UPS runtime is variable, it depends on what percentage of the UPS capacity the total equipment load represents. For example, a 1000VA capacity UPS may only support a 1000VA (100%) load for 5 minutes. This relationship is not linear, the same UPS may support a 500VA (50%) load for 16 minutes. Therefore, the lower the percentage of maximum capacity used, the increasingly longer the UPS runtime, for example up to 8 hours.

- **How frequent are the power losses?**

You also need to include allowance for the UPS recharge time. For most UPS's the ratio of discharge to full recharge time is 1:10.

- **How many output sockets does the UPS provide?**

Multiple UPS units may be required to ensure that every item of supported equipment has its own supply socket.

### Example Values

The dominate factor in the power consumption of an IP Office system is the telephones attached to the control unit and any external expansion modules. This does not include IP telephones which require their own separate power supplies. If any server PCs are being used by the system, the requirements of those PCs should also be included in the assessment. Similarly support for adjunct systems such as DECT should be considered.

The following are worst case figures tested found using fully populated control units and external expansion modules:

- **IP500 V2 Control Unit:** 115W.
- **IP500 Digital Station 16 External Expansion Module:** 31W.
- **IP500 Digital Station 30 External Expansion Module:** 56W.
- **IP500 DS16A Digital Station RJ21 External Expansion Module:** 34W.
- **IP500 DS30A Digital Station RJ21 External Expansion Module:** 60W.
- **IP500 Phone 16 External Expansion Module:** 25W.
- **IP500 Phone 30 External Expansion Module:** 45W.
- **IP500 Analog Trunk Module 16 External Expansion Module:** 8.8W.



## 1.9.4 Cabling and Cables

The IP Office systems are designed primarily for use within an RJ45 structured cabling system using CAT3 unshielded twisted-pair (UTP) cabling and RJ45 sockets.

A structured cabling system is one where cables are run from a central RJ45 patch panel in the communications/data room to individual RJ45 sockets at user locations. All wires in each cable between the patch panel and the desk socket are connected straight through. This arrangement allows devices connected at the patch panel to be swapped to match the type of device that needs to be connected at the user socket. For example, making one user socket a phone port and another user socket a computer LAN port, without requiring any rewiring of the cables between the patch panel and the user location.

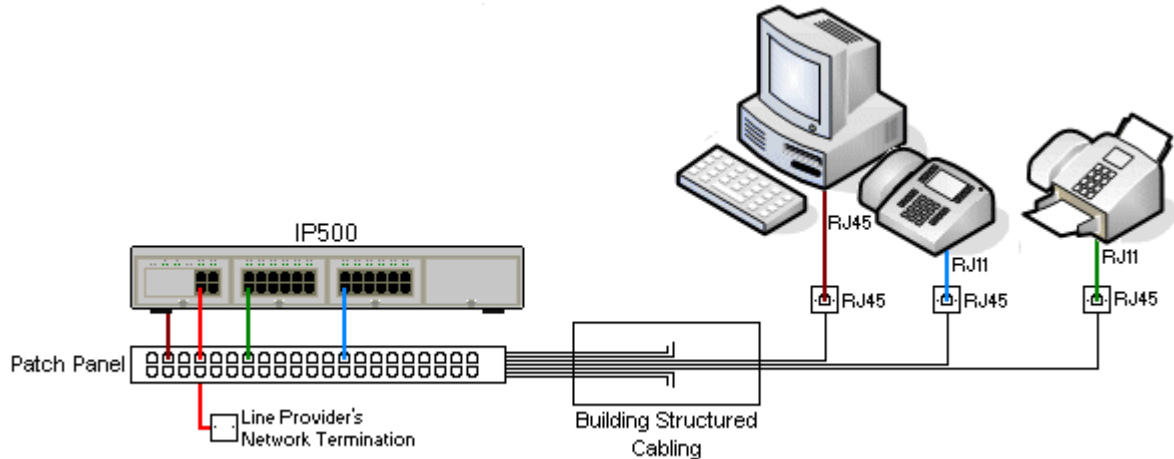

- **Traditional IDC Punchdown Wiring Installations**

Where necessary, the far end RJ45 plug can be stripped from IP Office cables and wired into traditional wiring systems using punch-block connectors. This type of installation should be performed by an experienced wiring technician.

- **Trunk Connections**

The majority of IP Office trunk ports use RJ45 connectors for acceptance of an RJ45-to-RJ45 cable. However, connection at the line provider's end may require use of a different plug type in order to match the line providers equipment.

- **RJ11 Phone Connectors**

Many phones use RJ11 sockets and are supplied with RJ11-to-RJ11 cables. RJ11 plugs can be inserted into RJ45 sockets and in many case the connection will work. However this is not recommended or supported as the connection lock is not truly positive and may become disconnected. An [RJ45-to-RJ11 cable](#)<sup>[36]</sup> is available for these connections.

## Standard IP Office Cables

The following are Avaya standard cables available for use with IP Office systems. The maximum length is applicable if the standard Avaya cable is replaced with an alternate cable.

Cable	Description	SAP Code	Standard Length	Maximum Length
<a href="#">9-Way DTE Cable</a> <sup>[367]</sup>	Connects to control unit RS232 DTE port. 9-Way D-type plug to 9-way D-type socket.	-	2m/6'6".	2m/6'6".
<a href="#">Structured Cabling DS Line Cable</a> <sup>[366]</sup>	Connects from RJ45 sockets to RJ11 socketed DS and analog phones.	TT700047871	4m/13'2".	See table below.
<a href="#">BRI/PRI Trunk Cable</a> <sup>[358]</sup>	Connects BRI/PRI trunk ports to the line provider's network termination point. RJ45 to RJ45. Red.	700213440	3m/9'10".	-
<a href="#">Expansion Interconnect Cable</a> <sup>[362]</sup>	Connects the control unit to expansion modules. RJ45 to RJ45. Blue. May be replaced by a yellow interconnect cable (2m (6'6") - 700472871) supplied with the <a href="#">IP500 4-Port Expansion</a> <sup>[20]</sup> card when using that card.	700213457	1m/3'3".	1m/3'3".
<a href="#">LAN Cable</a> <sup>[363]</sup>	Connects from IP Office LAN ports to IP devices. RJ45 to RJ45. Grey.	700213481	3m/9'10".	100m/328'.

The table below details the maximum total cable distances for DS and analog extensions using different cable thicknesses. Cabling should be Category-1 unshielded twisted pair cable or better.

Telephone	Unshielded Twisted-Pair (UTP) - 50nf/Km		
	AWG22 (0.65mm)	AWG24 (0.5mm)	AWG26 (0.4mm)
<b>1400 Series</b>	1200m/3937'.	1000m/3280'.	670m/2200'.
<b>2400/5400 Series</b>	1200m/3937'.	1000m/3280'.	670m/2200'.
<b>4406D Phone</b>	1000m/3280'.	1000m/3280'.	400m/1310'.
<b>4412D Phone</b>	1000m/3280'.	700m/2295'.	400m/1310'.
<b>4424D</b>	500m/1640'.	500m/1640'.	400m/1310'.
<b>9500 Series</b>	1200m/3937'.	1000m/3280'.	670m/2200'.
<b>T3 Series</b>	1000m/3280'.	1000m/3280'.	400m/1310'.
<b>BST</b>	580m/1900'.	365m/1200'.	228m/750'.
<b>Analog Phones</b>	1000m/3280'.	1000m/ 3280'.	400m/1640'.
<b>ETR Phones</b>	305m/1000'.	305m/1000'.	122m/400'.

## 1.9.5 Grounding



All IP Office control units and external expansion modules must be connected to a functional ground. Where the unit is connected to a power outlet using a power cord with an earth lead, the power outlet must be connected to a protective earth.

Use of ground connections reduces the likelihood of problems in most telephony and data systems. This is especially important in buildings where multiple items of equipment are interconnected using long cable runs, for example phone and data networks.

In some cases, such as ground start trunks, in addition to being a protective measure, this is a functional requirement for the equipment to operate. In other cases it may be a locale regulatory requirement and or a necessary protective step, for example areas of high lightning risk.

-  **WARNING**

During installation do not assume that ground points are correctly connected to ground. Test ground points before relying on them to ground connected equipment.

The ground point on IP Office control units and external expansion modules are marked with a  or  symbol. Ground connections to these points should use a 14 AWG solid wire with either a green sleeve for a functional ground or green and yellow sleeve for a protective ground.

- **Additional protective equipment**

In addition to grounding, additional protective equipment will be required in the following situations. Refer to "[Out of Building Telephone Installations](#)"<sup>36</sup>.

- On any Digital Station or Phones external expansion module connected to an extension located in another building.
- In the Republic of South Africa, on all Analog Trunk external expansion modules (ATM16) and on any control units containing an analog trunk cards (ATM4/ATM4U).

## 1.9.6 Lightning Protection/Out-of-Building Connections

The following are the only supported scenarios in which wired extensions and devices outside the main building can be connected to the IP Office system. In these scenarios, additional protection, in the form of protective grounding and surge protectors, must be fitted.

- ⚠ WARNING**

The fitting of additional protection does not remove the risk of damage. It merely reduces the chances of damage.

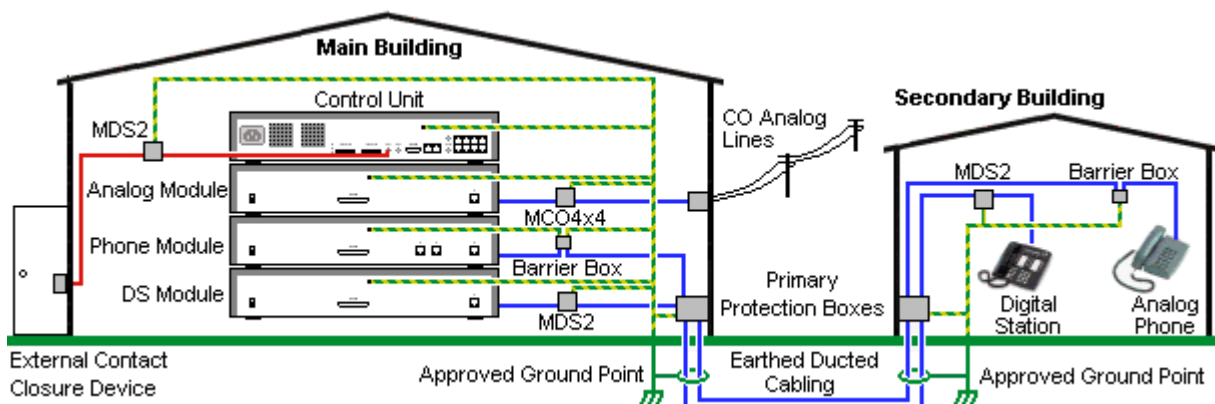

- Cables of different types, for example trunk lines, phone extensions, ground and power connections, should be kept separate.
- All cabling between buildings should be enclosed in grounded ducting. Ideally this ducting should be buried.
- A Primary Protection Box must be provided at the point where the cables enter the building. This should be three point protection (tip, ring and ground). Typically this would be gas tube protection provided by the local telephone company. The ground wire must be thick enough to handle all the lines being affected by indirect strike at the same time.

Connection Type	Protection Device Type	Requirement
<b>Analog Phone Extensions</b> Phones External expansion module (POT <sup>[365]</sup> or PHONE <sup>[365]</sup> ) ports only.	<b>IP Office Barrier Box</b> <sup>[174]</sup> Supports a single connection. Maximum of 16 on any expansion module.	<ul style="list-style-type: none"> <li>Connection from the expansion module to the phone must be via a surge protector at each end and via the primary protection point in each building.</li> <li>The IP Office external expansion modules, control unit and IROB devices must be connected to the protective ground point in their building.</li> <li>The between building connection must be via earthed ducting, preferable underground. The cable must not be exposed externally at any point.</li> </ul>
<b>DS Phone Extensions</b>	<b>ITW Linx MDS2</b> <sup>[173]</sup> Supports up to 4 connections. This device was previously referred to as the Avaya 146E.	<ul style="list-style-type: none"> <li>The between building connection must be via earthed ducting, preferable underground. The cable must not be exposed externally at any point.</li> </ul>
<b>BST Phone Extensions</b>	None	Currently not supported.
<b>Analog Trunks</b>	<b>ITW Linx MCO4x4</b> <sup>[173]</sup> Supports up to 4 two-wire lines. This device was previously referred to as the Avaya 146C.	<p>For installations in the Republic of South Africa, the fitting of surge protection on analog trunks is a requirement.</p> <p>For other locations where the risk of lightning strikes is felt to be high, additional protection of incoming analog trunks is recommended.</p>
<b>External Output Switch</b>	<b>ITW Linx MDS2</b> <sup>[173]</sup> Supports up to 4 connections. This device was previously referred to as the Avaya 146E.	<p>Connections from an IP Office Ext O/P port to an external relay device must be via a surge protector.</p> <p>When using the MDS2 on the Ext O/P port, use only the Line 1 and Equipment 1 jacks, do not use the Line 2 or Equipment 2 jacks.</p>

## 1.10 Wall and Rack Mounting

All the IP Office control units are designed to be free-standing. On systems with external expansion modules, the control unit and modules are intended to be stacked.

Using additional option mounting kits, some systems can be wall or rack mounted.

Control/Expansion Unit	Wall Mount	Rack Mount
IP500 Control Unit	✓	✓
IP500 V2 Control Unit	✓	✓
IP500 External Expansion Modules	✓	✓

### Wall Mounting

IP500 V2 control units and IP500 external expansion modules can be wall or rack mounted. To do this, a wall mounting kit is required in addition to suitable wall fixings.

In addition to the existing [environmental requirements](#)<sup>[53]</sup> for an IP Office system, the following additional requirements apply when wall mounting a unit:

- The wall surface must be vertical, flat and vibration free. Attachment to temporary walls is not supported.
- Only the screws provided with the mounting kit should be used to attach the brackets to the control unit.

The following wall and rack mounting kit is currently available:

- **IPO IP500 RACK MNTG KIT V3** (SAP Code 700503160)

These kits can be used for wall and rack mounting of an IP500 V2 control unit and IP500 external expansion modules. The kits incorporate cable routing at the front and rear of the unit. For wall mounted control units it allows orientation of the control unit base card slots to the left or to the right.

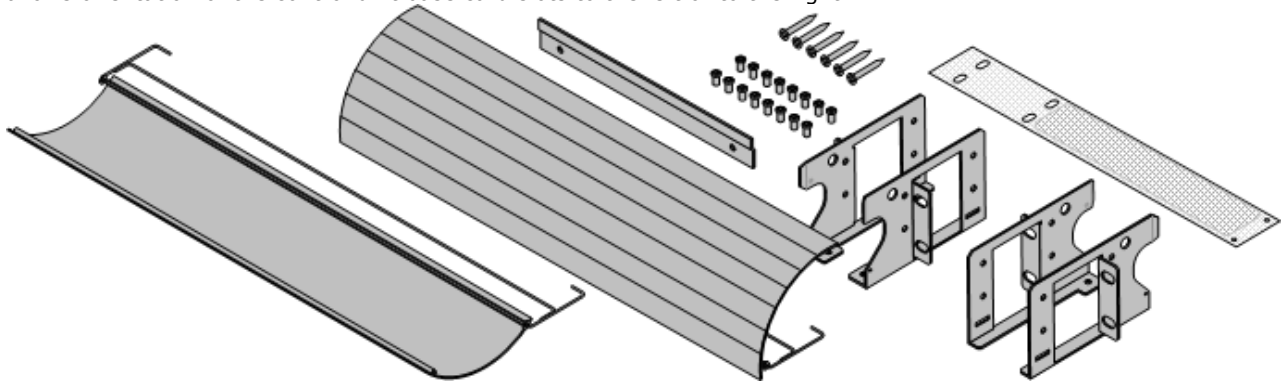

### Rack Mounting

All IP Office control units and external expansion modules can be rack mounted into standard 19" rack systems. Each unit requires a 2U slot space within the rack. The IPO IP500 RACK MNTG KIT V3 is used for rack mounting of units.

Where IP Office systems are being rack mounted, the effect of conditions within the rack cabinet must be considered. For example the rack temperature may be above the room temperature and airflow within the rack will be restricted. The [environmental requirements](#)<sup>[53]</sup> for the individual IP Office units are still applicable inside the rack cabinet.

### Barrier Box Rack Mounting Kit

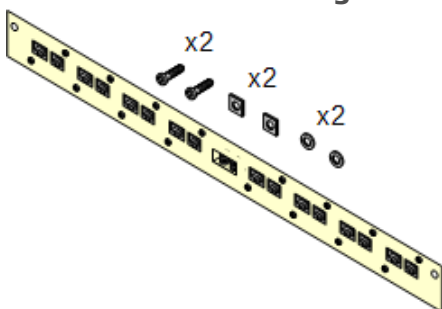

- **Barrier Box Rack Mounting Kit** (SAP 700293905)  
Barrier boxes must be used for [out-of-building analog phone extensions](#)<sup>[36]</sup>. This bracket allows up to 8 IP Office barrier boxes to be rack mounted and simplifies the number of connections to the protective ground point in the rack. This kit must be used when more than 3 barrier boxes are in use and supports a maximum of 16 barrier boxes for a single external expansion module.

---

## 1.11 Feature Keys and Licenses

A feature key is required for licensed features. For IP500 V2 systems the system SD card is used as the feature key.



- **IP500 V2 Avaya SD Card**<sup>[196]</sup>  
Inserts into the System slot on the rear of an IP500 V2 control unit. This card is required even if not using any IP Office licenses.

Various IP Office features and applications require entry of [licenses](#)<sup>[368]</sup> into the system's configuration. The licenses are unique 32-character codes based on the feature being activated and the serial number of the [System SD](#)<sup>[196]</sup> card installed with the IP Office system. The serial number is printed on the System SD card and prefixed **FK**. It can also be viewed in the system configuration using IP Office Manager.

When a license is entered into the IP Office configuration, the following information is shown.

- **Status**  
The status, which is **Unknown** until the configuration file is sent back to the IP Office system.
  - **Unknown**  
This status is shown for licenses that have just been added to the configuration shown in IP Office Manager. Once the configuration has been sent back to the IP Office and then reloaded, the status will change to one of those below.
  - **Valid**  
The features licensed can be configured and used.
  - **Invalid**  
The license was not recognized. It did not match the serial number of the System SD card.
  - **Dormant**  
The license is valid but is conditional on some other pre-requisite that is not currently meet.
  - **Obsolete**  
The license is valid but is one no longer used by the level of software running on the system.
  - **Expired**  
The license has passed its expiry date.
- **License**  
The name of the licensed feature. This may differ from the ordered RFA name.
- **Instances**  
Depending on the license, this may be the number of ports enabled or number of simultaneous users of the licensed feature. Sometime the number of instances is specified in the license name.
- **Expires**  
Most purchased licenses have no expiry setting. For some features, trial licenses may be available which will have an expiry date.

## 1.12 IP Office Phones

IP Office Release 9.1 supports the following phones and phone add-ons. Availability may depend on location and may be subject to local restrictions.

### Enhanced Tip and Ring (ETR Ports)

These phones are only supported on an ETR6 card in a IP500 V2 systems. They are only supported in IP Office Basic Edition - PARTNER® Mode and IP Office Basic Edition systems running a North American locale and U-Law companding.

- **ETR Series:** [ETR6](#)<sup>[310]</sup>, [ETR6D](#)<sup>[310]</sup>, [ETR18](#)<sup>[311]</sup>, [ETR18D](#)<sup>[311]</sup>, [ETR34D](#)<sup>[312]</sup> (*ETR 34D phones are limited to a maximum of 2 per card and 4 in total*)
- **PARTNER DECT:** [3910](#)<sup>[270]</sup>, [3920](#)<sup>[270]</sup>

### Avaya DS Digital Telephones (DS Ports)

These digital stations connect to the IP Office via [DS](#)<sup>[360]</sup> ports. They are supported by all IP Office modes.

- **1400 Series:** [1403](#)<sup>[240]</sup>, [1408](#)<sup>[247]</sup>, [1416](#)<sup>[240]</sup>
- **9500 Series:** [9504](#)<sup>[280]</sup>, [9508](#)<sup>[280]</sup>

The following additional DS port phones are only supported in IP Office standard modes:

- **2400 Series:** [2402](#)<sup>[250]</sup>, [2410](#)<sup>[250]</sup>, [2420](#)<sup>[257]</sup>.
- **3800 Series:** [3810 Wireless phone](#)<sup>[260]</sup> (Only supported on external expansion modules).
- **4400 Series:** [4406D](#)<sup>[271]</sup>, [4412D+](#)<sup>[272]</sup>, [4424D+](#)<sup>[273]</sup> (Only supported on external expansion modules).
- **5400 Series:** [5402](#)<sup>[280]</sup>, [5410](#)<sup>[281]</sup>, [5420](#)<sup>[282]</sup>.
- **T3 Series:** [T3 Compact](#)<sup>[320]</sup>, [T3 Classic](#)<sup>[322]</sup>, [T3 Comfort](#)<sup>[323]</sup>.

### Avaya BST Digital Telephones (BST Ports)

These digital stations connect to the IP500 V2 IP Office system via BST ports.

- **4100 Series:** 4135, 4136, 4145, 4145EX, 4146, 4146EX - Connection to IP Office BST ports via a [Digital Mobility Solution](#)<sup>[337]</sup> system.
- **7400 Series:** 7420, 7430, 7434, 7439, 7440, 7444, 7449 - Connection to IP Office BST ports via a [Digital Mobility Solution](#)<sup>[337]</sup> system.
- **ACU:** [Audio Conferencing Unit](#)<sup>[300]</sup>
- **M-Series:** [M7100](#)<sup>[313]</sup>, [M7100N](#)<sup>[313]</sup>, [M7208](#)<sup>[314]</sup>, [M7208N](#)<sup>[314]</sup>, [M7310](#)<sup>[315]</sup>, [M7310N](#)<sup>[315]</sup>, [M7324](#)<sup>[316]</sup>, [M7324N](#)<sup>[316]</sup>.
- **T-Series:** [T7000](#)<sup>[317]</sup>, [T7100](#)<sup>[317]</sup>, [T7208](#)<sup>[318]</sup>, [T7316](#)<sup>[319]</sup>, [T7316E](#)<sup>[320]</sup>, [T7406](#)<sup>[321]</sup>, [T7406E](#)<sup>[321]</sup>

### Analog Telephones

Analog phones and devices connect to [PHONE](#)<sup>[360]</sup> ports with the IP Office system. However due to the variety of analog phones and device available no guarantee of operation is given. It is the responsibility of the IP Office installer and maintainer to test and verify the operation of proposed analog equipment. Analog message waiting indication (MWI) is only supported with Avaya 6200 Series phones.

- **6200 Series:** 6211, 6219, 6221 (*North America*).
- **B100 Series:** [B149](#)<sup>[307]</sup>, [B159](#)<sup>[307]</sup>, B169.
- **Interquartz Gemini:** 9330-AV, 9335-AV, 9281-AV (*Europe, Middle East, Africa, Asia-Pacific*).

### IP Telephones

IP Phones (SIP and H323) connect to the IP Office system via the RJ45 LAN or WAN. These device require an Avaya IP Endpoint license and voice compression resources. They are not supported in IP Office Basic Edition - PARTNER® Mode, IP Office Basic Edition - Norstar Mode and IP Office Basic Edition mode.

#### H323:

- **1600 Series:** [1603IP/SW](#)<sup>[240]</sup>, [1608](#)<sup>[251]</sup>, [1608-I](#)<sup>[251]</sup>, [1616](#)<sup>[253]</sup>, [1616-I](#)<sup>[253]</sup>
- **3600 Series:** [3616](#)<sup>[250]</sup>, [3620](#)<sup>[250]</sup>, [3626](#)<sup>[260]</sup>, [3641](#)<sup>[261]</sup>, [3645](#)<sup>[262]</sup>
- **3700 Series:** [3701](#)<sup>[263]</sup>, [3711](#)<sup>[264]</sup> - Connection via DECT base stations. [3720](#)<sup>[265]</sup>, [3725](#)<sup>[266]</sup>, [3740](#)<sup>[267]</sup>, [3749](#)<sup>[268]</sup> - Connection via DECT R4 base stations.
- **4600 Series:** [4601](#)<sup>[274]</sup>, [4602](#)<sup>[275]</sup>, [4602SW](#)<sup>[275]</sup>, [4610](#)<sup>[276]</sup>, [4610SW](#)<sup>[276]</sup>, [4620](#)<sup>[277]</sup>, [4620SW](#)<sup>[277]</sup>, [4621SW](#)<sup>[278]</sup>, [4625](#)<sup>[279]</sup>.
- **5600 Series:** [5601](#)<sup>[283]</sup>, [5602](#)<sup>[284]</sup>, [5602SW](#)<sup>[284]</sup>, [5610](#)<sup>[285]</sup>, [5620](#)<sup>[286]</sup>, [5621](#)<sup>[287]</sup>.
- **9600 Series:** [9608](#)<sup>[290]</sup>, [9608G](#)<sup>[290]</sup>, [9611G](#)<sup>[292]</sup>, [9620L](#)<sup>[294]</sup>, [9620C](#)<sup>[294]</sup>, [9621G](#)<sup>[290]</sup>, [9630G](#)<sup>[290]</sup>, [9640](#)<sup>[300]</sup>, [9640G](#)<sup>[300]</sup>, [9641G](#)<sup>[302]</sup>, [9650](#)<sup>[304]</sup>, [9650C](#)<sup>[304]</sup>.
- **T3 IP Series:** [T3 IP Compact](#)<sup>[324]</sup>, [T3 IP Classic](#)<sup>[322]</sup>, [T3 IP Comfort](#)<sup>[323]</sup>.

#### SIP:

- **1000 Series:** [1010](#)<sup>[244]</sup>, [1040](#)<sup>[244]</sup>
- **1100 Series:** [1120E](#)<sup>[245]</sup>, [1140E](#)<sup>[245]</sup>

- 
- **1200 Series:** [1220](#)<sup>[245]</sup>, [1230](#)<sup>[245]</sup>
  - **B100 Series:** [B179](#)<sup>[307]</sup>.
  - **D100 Series:** These DECT handsets (up to 8) use a base station that connects to the IP Office system using a SIP trunk and appear on the IP Office as SIP extensions.
  - **E129:** A simple SIP telephone, the [E129](#)<sup>[309]</sup> support auto-answer, handsfree and headset operation.
  - **E169:** A SIP telephone that supports the docking of mobile devices.



## 1.13 VoIP

IP Office is a converged telephony system, that is it combines aspects of traditional PABX telephone systems and IP data and telephony systems. This works at various levels.

- Individual phone users can control the operation of their phone through applications running on their PC.
- Data traffic can be routed from the LAN interface to a telephony trunk interface, for example a dial-up ISP connection.
- Voice traffic can be routed across internal and external data links. This option is referred to as voice over IP (VoIP).

The VoIP mode of operation can include external SIP trunks, IP trunks between customer systems and/or H.323 or SIP IP telephones for users. In either case the following factors must be considered:

- The IP Office control unit must be fitted with [voice compression channels](#)<sup>42</sup>. These are used whenever an IP device (trunk or extension) needs to communicate with a non-IP device (trunk or extension) or to a device that uses a different codec.
- A network assessment is a mandatory requirement for all systems using VoIP. For support issues with VoIP, Avaya may request access to the network assessment results and may refuse support if those are not available or satisfactory.

A network assessment would include a determination of the following:

- A network audit to review existing equipment and evaluate its capabilities, including its ability to meet both current and planned voice and data needs.
- A determination of network objectives, including the dominant traffic type, choice of technologies, and setting voice quality objectives.
- The assessment should leave you confident that the implemented network will have the capacity for the foreseen data and voice traffic, and can support H.323, DHCP, TFTP and jitter buffers in H.323 applications.
- An outline of the expected network assessment targets is:

Test	Minimum Assessment Target
Latency	Less than 150ms.
Packet Loss	Less than 3%.
Duration	Monitor statistics once every minute for a full week.

## 1.13.1 Voice Compression Channels

Calls to and from IP devices can require conversion to the audio codec format being used by the IP device. For IP Office systems this conversion is done by voice compression channels. These support the common IP audio codecs G.711, G.723 and G.729a. For IP Office Release 8.0 and higher, IP500 VCM and IP500 Combination cards also support G.722.

For IP500 V2 control units, channels can be added using [IP500 VCM cards](#)<sup>[212]</sup> and [IP500 Combination Cards](#)<sup>[203]</sup>.

The voice compression channels are used as follows:

Call Type	Voice Compression Channel Usage
<b>IP Device to Non-IP Device</b>	These calls require a voice compression channel for the duration of the call. If no channel is available, busy indication is returned to the caller.
<b>IP Device to IP Device</b>	<p>Call progress tones (for example dial tone, secondary dial tone, etc) do not require voice compression channels with the following exceptions:</p> <ul style="list-style-type: none"> <li>• Short code confirmation, ARS camp on and account code entry tones require a voice compression channel.</li> <li>• Devices using G723 require a voice compression channel for all tones except call waiting.</li> </ul> <p>When a call is connected:</p> <ul style="list-style-type: none"> <li>• If the IP devices use the same audio codec no voice compression channel is used.</li> <li>• If the devices use differing audio codecs, a voice compression channel is required for each.</li> </ul>
<b>Non-IP Device to Non-IP Device</b>	No voice compression channels are required.
<b>Music on Hold</b>	This is provided from the IP Office's TDM bus and therefore requires a voice compression channel when played to an IP device.
<b>Conference Resources and IP Devices</b>	Conferencing resources are managed by the conference chip which is on the IP Office's TDM bus. Therefore, a voice compression channel is required for each IP device involved in a conference. This includes services that use conference resources such as call listen, intrusion, call recording and silent monitoring.
<b>Page Calls to IP Device</b>	IP Office 4.0 and higher only uses G729a for page calls, therefore only requiring one channel but also only supporting pages to G729a capable devices.
<b>Voicemail Services and IP Devices</b>	Calls to the IP Office voicemail servers are treated as data calls from the TDM bus. Therefore calls from an IP device to voicemail require a voice compression channel.
<b>Fax Calls</b>	These are voice calls but with a slightly wider frequency range than spoken voice calls. IP Office only supports fax across IP between IP Office systems with the Fax Transport option selected. It does not currently support T38.
<b>T38 Fax Calls</b>	<p>IP Office 5.0+ supports T38 fax on SIP trunks and SIP extensions. Each T38 fax call uses a VCM channel.</p> <p>Within a Small Community Network, a T38 fax call can be converted to a call across an H323 SCN lines using the IP Office Fax Transport Support protocol. This conversion uses 2 VCM channels.</p> <p>In order use T38 Fax connection, the <b>Equipment Classification</b> of an analog extension connected to a fax machine can be set <b>Fax Machine</b>. Additionally, a new short code feature <b>Dial Fax</b> is available.</p>

Note: T3 IP devices must be configured to 20ms packet size for the above conditions to apply. If left configured for 10ms packet size, a voice compression channel is needed for all tones and for non-direct media calls.

### Measuring Channel Usage

The System Status Application can be used to display voice compression channel usage. Within the **Resources** section it displays the number of channel in use. It also displays how often there have been insufficient channels available and the last time such an event occurred.

The IP500 VCM cards, channel usage is also indicated by the LEDs (1 to 8) on the front of the [IP500 VCM card](#)<sup>[212]</sup>.

## 1.14 Supported Country Locales

When a new or defaulted system's configuration is first opened in IP Office Manager, the value set in the **Locale** field should always be checked and changed if necessary.

The system's locale sets factors such as the default ringing patterns and caller display settings. The locale also controls the language that a voicemail server will attempt to use for prompts by default.

- The supported countries are **Argentina, Australia, Bahrain, Belgium, Brazil, Canada, Chile, China, Czech, Denmark, Egypt, Finland, France, Germany, Greece, Hong Kong, Hungary, Iceland, India, Italy, Japan, Korea, Kuwait, Mexico, Morocco, Netherlands, New Zealand, Norway, Oman, Pakistan, Peru, Philippines, Poland, Portugal, Qatar, Russia, Saudi Arabia, Singapore, South Africa, Spain, Sweden, Switzerland, Taiwan, Turkey, United Arab Emirates, United States, Venezuela.**

## 1.15 IP Office Software Applications

The IP Office applications are available on a number of DVDs. These can be ordered at a nominal cost to cover order processing and delivery. Separate installation packages for IP Office applications can also be downloaded from the Avaya support website at <http://support.avaya.com>.

Title	Discs	Description	SAP Code
<b>IP Office Release 9.1 Admin and User DVD Set</b>	2	These DVDs contain installation packages for all the main IP Office administration and user applications. They also contain documentation for IP Office. <ul style="list-style-type: none"><li>• <b>DVD 1:</b> Contains the IP Office Administrator Applications suite, IP Office Documentation, IP Office User Applications, IP Office Voicemail Pro.</li><li>• <b>DVD 2:</b> Contains the ContactStore for IP Office and one-X Portal for IP Office applications.</li></ul>	700506051
<b>Voicemail Pro ScanSoft TTS DVD Set</b>	2	Contains text to speech engines for use with Voicemail Pro's TTS functions. Supports the same languages as Voicemail Pro pre-recorded prompts except Hungarian.	700478068
<b>IP Office Release 9.1 Server Edition Installation DVD</b>	2	Installation DVD for Server Edition servers and IP Office Application Server. The second DVD contains open source material used for the first DVD.	700506052
<b>Virtualized IP Office Server Edition DVD</b>	1	Installation DVD for Virtualized Server Edition servers and Virtualized IP Office Application Server.	700507516
<b>IP Office Linux Server TTS DVD Set</b>	3	Contains text to speech engines for use with Linux based Voicemail Pro's TTS functions.	700502693

- It is acceptable to make copies of the Avaya IP Office DVDs listed above. However the content must remain intact, unaltered and without change or addition. Avaya does not accept any liability and responsibility for damage or problems arising from the use of such copies.

## 1.15.1 Programming Applications

The following applications are used to program and maintain an IP Office system. Typically they run on a PC connected to the IP Office system via its LAN interface. These applications are all provided on the IP Office Administrator Applications DVD and don't require any licenses.

Due to the nature of the applications, if installed on a PC at the customer site, this should be a secure PC or the PC of a trusted user. If a voicemail server PC is also being installed with the IP Office system, the same PC can be used for the programming and maintenance applications.

For maintainers, these applications can also be run remotely if a route for data connections to the customer's IP Office exists from the maintainer's location.

- **IP Office Manager Version**

It is important to download and install the correct version of the IP Office administration suite including IP Office Manager.

- For system installation, you should use the version of IP Office Manager that matches the IP Office release required on the system. The sets the version of IP Office software loaded when [recreating the System SD card](#)<sup>[75]</sup>.
- For system maintenance, the version of IP Office Manager used sets the version of IP Office software uploaded to a system when [upgrading the system](#)<sup>[164]</sup>.
- For system configuration IP Office Manager is backward compatible. IP Office Manager Version 9.1 is backwards compatible for configuring systems running software from IP Office Release 6.0 upwards. IP Office Manager cannot load the configuration of an IP Office system running a higher version of software.

- **! IP Office Technical Bulletins**

You must obtain and read the IP Office Technical Bulletin relating to the IP Office software release which intend to install. The bulletin contains important information that may not have been included in this manual. IP Office Technical Bulletins are available from the [Avaya support](http://support.avaya.com) website (<http://support.avaya.com>).

- **! Upgrade Licenses**

Some upgrades may require entry of upgrade licenses. It is still possible to upgrade the system without the necessary licenses, however the system will not provide any telephony functions after the upgrade until the appropriate license is added to the system configuration.

### Applications

- **IP Office Manager**<sup>[34]</sup>

This tool is used to access all parts of the IP Office configuration. Different levels of access can be defined to control which parts of the configuration the IP Office Manager user can view and alter. IP Office Manager is also used to upgrade the software files used by an IP Office system.

- **IP Office Web Manager**

The configuration for an IP500 V2 system can be accessed via web browser using the same service user accounts as used for IP Office Manager. Currently, for IP Office standard mode systems, IP Office Web Manager can only be used to configure users, groups and service users (security accounts) and to perform basic maintenance actions. Therefore, IP Office Manager is still required for full system installation and maintenance.

- **System Status Application**<sup>[346]</sup>

This application can be used to inspect the current status of IP Office lines and extensions and to view records of recent alarms and events. It runs as a Java application.

- **SNMP MIBs**<sup>[180]</sup>

Not an application as such. Using IP Office SNMP MIB files the status of the IP Office system to be monitored by 3rd-party SNMP applications such as Castlerock and HP OpenView. When configured for SNMP operation, the IP Office can also send alerts for potential problems. IP Office systems also support the sending of the same alerts to SMTP email or Syslog addresses.

- The alarms configurable for output via SNMP can also be output to SMTP email and or Syslog.
- The use of SNMP is not supported with IP Office Basic Edition mode systems.

- **Monitor (SysMon)**<sup>[34]</sup>

Monitor is a tool that can show a trace of all activity on the IP Office system in detail. As a consequence, interpretation of Monitor traces requires a high-level of data and telephony protocol knowledge. Despite that however, all IP Office installers and maintainers need to understand how to run Monitor when necessary as Avaya may request copies of Monitor traces to resolve support issues.

---

## 1.15.2 User Applications

The IP Office supports a number of applications that operate in parallel with users telephones. These applications are installed from the IP Office Applications DVD. The one-X Portal for IP Office server can also be installed as part of the IP Office Application DVD installation.

Some of them require licenses to be entered into the IP Office system's configuration to enable features or to set the number of simultaneous users.

These applications are not supported with IP Office Basic Edition mode systems.

- [one-X Portal for IP Office](#)<sup>[347]</sup>  
This application is installed on a server PC connected to the IP Office. Users can access the one-X portal from their own PC using a web browser. The application allows the user to control their phones, access voicemail messages, call logs and phone directories.
- [SoftConsole](#)<sup>[344]</sup>  
This is a licensed application. It is intended for telephone system operators or receptionists. It displays details of calls and allows them to quickly see the status of the callers required destination and transfer the call. The SoftConsole user is able to access a range of details about the status of users and groups on the IP Office system. Up to 4 simultaneous SoftConsole users can be licensed.
- [Avaya Communicator](#)<sup>[343]</sup>  
This is a licenses application that runs on a various Windows, iPad and Android devices. Depending on configuration, a user can either use it in conjunction with their own phone to control calls or they can use it as their phone.
- [TAPILink Lite](#)<sup>[347]</sup>  
The Microsoft Telephony Application Program Interface (TAPI) allows TAPI compliant applications to interact with IP Office phones by installing an IP Office TAPI driver. TAPILink Lite does not require any licenses entered into the IP Office system's configuration. It allows TAPI compliant applications such as Outlook to make and answer calls. The speech part of the calls is still via the user's physical phone.

## 1.15.3 Voicemail Applications

The IP Office supports a range of applications for the recording and playing of voicemail messages.

- **Embedded Voicemail**  
Embedded Voicemail supports basic voicemail mailbox operation, simple auto-attendants and hunt group announcements. For IP500 V2 controls units, Embedded Voicemail is provided by the Avaya SD card fitted by default.
- [Voicemail Pro](#)<sup>[348]</sup>  
This voicemail application runs on a server PC connected to the IP Office. It requires various licenses entered into the IP Office configuration to control the features it offers and the number of simultaneous connections. The operation of Voicemail Pro can be customized to provide special services.
- [ContactStore for IP Office](#)<sup>[348]</sup>  
Voicemail Pro can be used for manual and automatic call recording. Those recording are placed into mailboxes. Contact Store allows those recordings to be redirected into a database on the ContactStore PC. This allows recordings to be archived and searched separately from mailbox messages. This application requires entry of a license into the IP Office configuration.

## 1.15.4 Call Logging Applications

A wide range of 3rd -party applications exist to provide call logging and accounting for telephone systems. To support these the IP Office provides an SMDR output.

- **SMDR Output**

For IP Office Release 5.0 and higher, the IP Office control unit directly outputs SMDR records to a specified IP address. This is configure using IP Office Manager.

## 1.15.5 Call Center Applications

The IP Office supports a number of contact center solutions.

- **IP Office Contact Center**

This application suite supports a range of module allowing calls to be routed to agents based on a range of factors.

- **Outbound Contact Express**

As the name suggests, this product is focussed around making outbound calls to a targeted set of numbers and then connecting answered calls to an agent. The IP Office system is supported as gateway for telephony services to the product.

- **Avaya Contact Center Select**

This is a large contact center solution for up to 250 agents.

## 1.15.6 CTI Applications

- **TAPILink Pro**

Using the same software as TAPILink Lite, TAPILink Pro provides all of the features and functionality of TAPILink Lite, but additionally provides third party CTI operation. This means that a single server can control and monitor any number of telephone devices. This requires entry of a CTI Link Pro license. TAPILink Pro also provides the ability to monitor and control groups. This allows an application to be notified when a call enters a queue, and can also redirect it to another location.

- **TAPI WAV driver**

Provides software-based support for voice processing. Purchasing the CTI Link Pro RFA license key also enables 4 ports of voice processing; additional ports can be purchased in 4 port increments. The TAPI-WAV driver is for use with TAPI 2.1 only; for TAPI 3.0, IP Office supports the Media Service Provider (MSP) interface, defined by Microsoft in TAPI 3.0.

- **DevLink Pro**

Provides a real-time event stream in addition to the SMDR interface provided in IP Office SMDR (see below). The real-time event stream takes the form of a call record, which is issued whenever the state of any endpoint of a call changes (typically there are two endpoints on a call, but for some circumstances, such as conference calls, intruded calls there may be more).

---

## 1.16 Training

Avaya University provides a wide range of training courses for IP Office and its associated applications. This includes courses necessary for IP Office resellers to become Avaya Authorized Channel Partners and for individuals to achieve IP Office certification.

Details of courses can be found on the Avaya University web site (<http://www.avaya-learning.com>). The site can be used to check course availability and to book course. It also includes on-line courses and on-line course assessments. The site requires users to setup a user name and password in order to track their personal training record.

## 1.17 Web Sites

Information to support the IP Office can be found on a number of web sites.

- **Avaya** (<http://www.avaya.com>)  
The official web site for Avaya. The front page also provides access to individual Avaya web sites for different countries.
- **Avaya Enterprise Portal** (<http://partner.avaya.com>)  
This is the official web site for all Avaya Business Partners. The site requires registration for a user name and password. Once accessed, the site portal can be individually customized for what products and information types you wish to see and to be notified about by email.
- **Avaya Support** (<http://support.avaya.com>)  
Contains documentation and other support materials for Avaya products including IP Office. Copies of the IP Office CD images are available from this site and updated core software .bin files.
- **Avaya IP Office Knowledge Base** (<http://marketingtools.avaya.com/knowledgebase>)  
Access to an on-line regularly updated version of the IP Office Knowledge Base.
- **Avaya University** (<http://www.avaya-learning.com>)  
This site provides access to the full range of Avaya training courses. That includes both on-line courses, course assessments and access to details of classroom based courses. The site requires users to register in order to provide the user with access to details of their training record.
- **Avaya Community** (<http://www.aucommunity.com>)  
This is the official discussion forum for Avaya product users. However it does not include any separate area for discussion of IP Office issues.
- **Other Non-Avaya Web Sites**  
A number of third-party web forums exist that discuss IP Office. These can act as useful source of information about how the IP Office is used. Some of these forums require you to be a member and to register. These are not official Avaya forums and their content is not monitored or sanctioned by Avaya.
  - **Tek-Tips** (<http://www.tek-tips.com>)
  - **IP Office Info** (<http://www.ipofficeinfo.com>)
  - **Yahoo Groups** (<http://groups.yahoo.com/group/ipoffice>)
  - **PBX Tech** (<http://www.pbxtech.info/forumdisplay.php?f=8>)



## 1.18 Emergency and Power Failure Ports

IP Office systems provide 2 types of analog extension power failure ports. In all cases these only work with loop-start analog trunks. Any phones connected to these ports should be clearly labeled as power fail extensions in accordance with the appropriate national and local regulatory requirements.

### Switching Power Failure Ports

During normal operation, these ports can be used for normal analog phone connection. During power failure, the ports connect directly to an analog trunk port.

This type of power failure port is provided by the following cards:

- **IP500 Analog Phone 8 Card**  
When an IP500 Analog Phone 8 base card is fitted with an IP500 Analog Trunk daughter card, during power failure extension port 8 is connected to analog trunk port 12.
- **IP500 ATM Combination Card/IP500 ATM Combination Card V2**  
On this card, during power failure, extension port 8 is connected to analog trunk port 12.

### Emergency Only Power Failure Ports

During normal operation, these ports cannot be used. During power failure, the ports connect directly to an analog trunk port.

- **IP500 Analog Trunk Daughter Card/IP500 Analog Trunk Daughter Card V2**  
Regardless of the IP500 card hosting it, during power failure pins 4 and 5 of port 12 are connected to pins 7 and 8.
- **IP500 ETR6 Card**  
On this card, during normal operation extension ports 7 and 8 are not useable. However, if the card is fitted with an IP500 Analog Trunk daughter card, during power failure extension ports 7 and 8 are connected to analog trunk port 12.



# Chapter 2.

# Installation Overview

---

## 2. Installation Overview

This installation process is a simple outline. Many steps can be completed before the actual installation at the customer site.

### Installation process summary

1. [Prepare for installation](#) <sup>52</sup>
  - a. [Environmental Requirements](#) <sup>53</sup>  
Check that the installation area meets the system environmental requirements.
  - b. [Space Requirements](#) <sup>54</sup>  
Check that the installation area meets the system space requirements.
  - c. [Tools and Parts Required](#) <sup>59</sup>  
Check that you have the tools and additional parts required.
  - d. [Documentation](#) <sup>60</sup>  
Ensure that you have obtained and read all the relevant documentation.
  - e. [Unpacking](#) <sup>61</sup>  
Check that all the required equipment has been delivered and that there is no damage.
2. [Admin Software Installation](#) <sup>64</sup>

For system installation you need a PC with the IP Office administrator software installed. This must include a copy of IP Office Manager that matches the IP Office software level required.

  - a. [Downloading the Software](#) <sup>64</sup>
  - b. [Installing the Administrator Applications](#) <sup>66</sup>
3. [Preparing the System SD card](#) <sup>74</sup>

Upgrade the System SD card to the required releaser of IP Office software. In addition add any other files available such as the license file, pre-built configuration, music-on-hold file.

  - **! WARNING: Installing PCS14 and earlier control units**  
[PCS](#) <sup>388</sup> 14 or lower units must first install Release 8.1(65) (or higher 8.1) or any Release 9.0 and then upgrade to Release 9.1. Care should be taken to ensure that no calls are made before the upgrade to Release 9.1, otherwise the system will require an 9.1 upgrade license despite being "new". The PCS of the control unit is printed on the label on the back of the control unit.
4. [Install the control unit cards](#) <sup>80</sup>

Attach any trunk daughter cards to their IP500 base cards and insert the base cards into the control unit.
5. [Install the system](#) <sup>84</sup>
  - a. [Wall Mounting](#) <sup>85</sup>  
If wall mounting, attach the brackets and fit the unit to the wall.
  - b. [Rack Mounting](#) <sup>87</sup>  
If rack mounting, attach the brackets and fit the control unit into the rack.
  - c. [Connect the External Expansion Modules](#) <sup>88</sup>  
Connect the external expansions modules to the control unit.
  - d. [Ground the system](#) <sup>90</sup>  
Attach required ground cables to the control unit and external expansion modules.
  - e. [LAN Network Connections](#) <sup>91</sup>  
Attach the control unit and a PC with IP Office Manager to the LAN network.
  - f. [Starting the System](#) <sup>92</sup>  
Insert the System SD card and power up the system.
  - g. [Connecting Phones](#) <sup>95</sup>  
Connect the Avaya digital phones.
6. [Initial configuration](#) <sup>98</sup>

Start basic configuration of the system using IP Office Manager.
7. [Securing the system](#) <sup>114</sup>

Change any default passwords and disable unneeded services.

## 2.1 Environmental Requirements

The planned location must meet the following requirements. If being installed into a rack system, these are requirements for within the rack:

1.  Temperature: 5°C to 40°C / 40°F to 104°F.
2.  Humidity: 10% to 95% non-condensing.
3.  Check there are no flammable materials in the area.
4.  Check there is no possibility of flooding.
5.  Check that no other machinery or equipment needs to be moved first.
6.  Check that it is not an excessively dusty atmosphere.
7.  Check that the area is unlikely to suffer rapid changes in temperature and humidity.
8.  Check for the proximity of strong magnetic fields, sources of radio frequency and other electrical interference.
9.  Check there are no corrosive chemicals or gasses.
10.  Check there is no excessive vibration or potential of excessive vibration, especially of any mounting surface.
11.  Check that where telephones are installed in another building, that the appropriate protectors and protective grounds are fitted (see [Out of Building Telephone Installation](#) <sup>[36]</sup>).
12.  Check there is suitable lighting for installation, system programming and future maintenance.
13.  Check that there is sufficient working space for installation and future maintenance.
14.  Ensure that likely activities near the system will not cause any problems, e.g. access to and maintenance of any other equipment in the area.
15.  Where ventilation holes are present on any of the IP Office units, those holes should not be covered or blocked.
16.  The surface must be flat horizontal for free-standing or rack mounted installations.

### Wall Mounting

In addition to the requirements above, the following are applicable to IP Office units that support wall mounting.

1. Units must only be mounted onto permanent wall surfaces.
2. The surface must be vertical and flat.
3. Orientation of the unit must be as shown in the section on [IP500 Wall Mounting](#) <sup>[85]</sup>.
4. The appropriate Avaya wall mounting kits must be used.

### IMPORTANT SAFETY INSTRUCTIONS

When using your telephone equipment, basic safety precautions should always be followed to reduce the risk of fire, electric shock and injury to persons, including the following:

1. Do not use this product near water, for example, near a bath tub, wash bowl, kitchen sink or laundry tub, in a wet basement or near a swimming pool.
2. Avoid using a telephone (other than a cordless type) during an electrical storm. There may be a remote risk of electric shock from lightning.
3. Do not use the telephone to report a gas leak in the vicinity of the leak.
4. Use only the power cord and batteries indicated in this manual.

---

## 2.2 Space Requirements

IP Office control units and modules are designed to be installed either in a free-standing stack or into a 19" rack system. Rack installation requires a [rack mounting kit](#)<sup>[37]</sup> for each control unit and expansion module.

- **Cable Clearance**  
Clearance must be provided at the front and rear of all modules for cable access. On IP500 V2 systems allow a minimum clearance of 90mm (3.5 inches).
- **Additional Clearance**  
Care should be taken to ensure that the positioning of the modules does not interrupt air flow and other factors that may affect [environmental requirements](#)<sup>[53]</sup>. This is especially important on IP500 V2 control units which have ventilation slots at the side.
- **Cable Access**  
Power cords must not be attached to the building surface or run through walls, ceilings, floors and similar openings. Installation measures must be taken to prevent physical damage to the power supply cord, including proper routing of the power supply cord and provision of a socket outlet near the fixed equipment or positioning of the equipment near a socket outlet.

## 2.2.1 Control Unit

The ventilation slots on the rear and sides should not be covered or blocked.

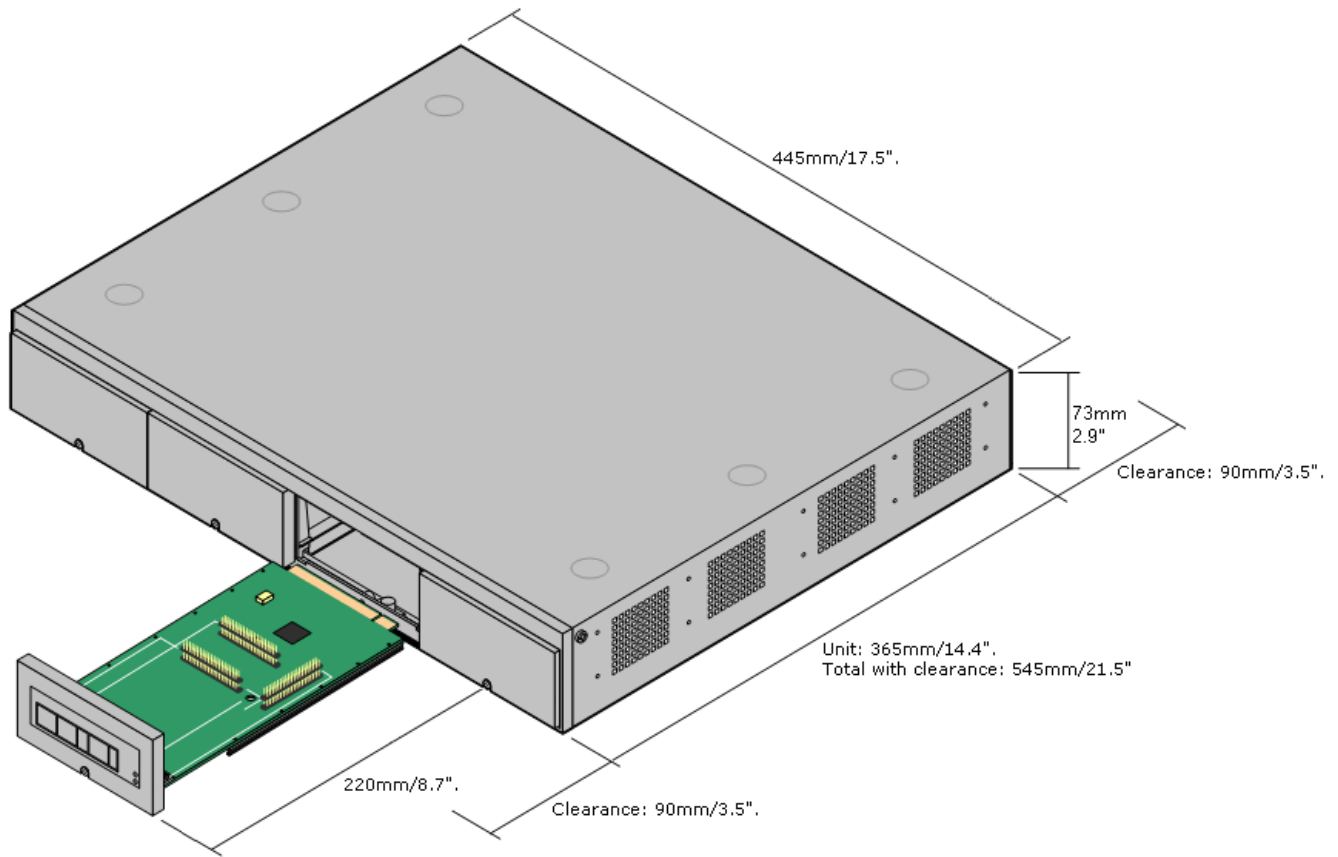

## 2.2.2 External Expansion Modules

The dimensions below are applicable to all IP Office external expansion modules.

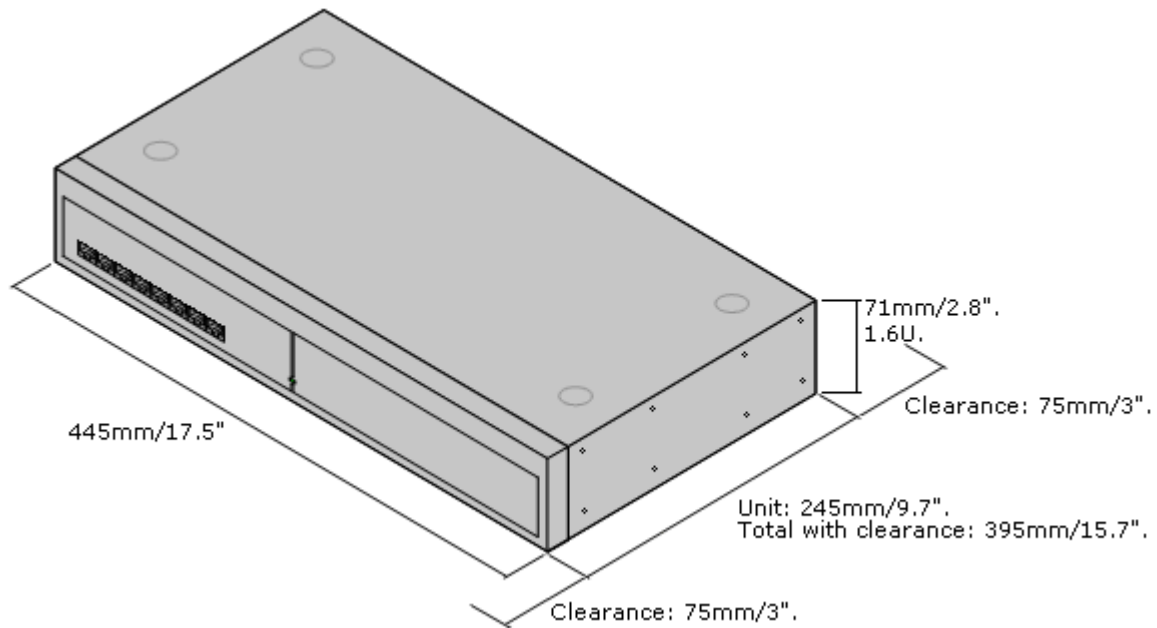

For free-standing systems, the external expansion modules can be stacked on top of the control unit. For that, and for rack mounted systems, the diagram below shows the recommended options to accommodate the length of the module interconnect cable.

The integral expansion ports on a control unit are located on the rear of the unit. For IP500 V2 control units, an additional 4 expansion ports can be added to the front of the control unit by installing an IP500 4-Port Expansion card.

- Each external expansion module is supplied with a blue 1 meter (3'3") expansion interconnect cable. This cable must be used when connecting to expansion ports on the rear of a control unit.
- When connecting to expansion ports on an IP500 4-Port Expansion card, a yellow 2 meter (6'6") expansion interconnect cable can be used in place of the standard blue cable. 4 Yellow cables are supplied with the IP500 4-Port Expansion card.

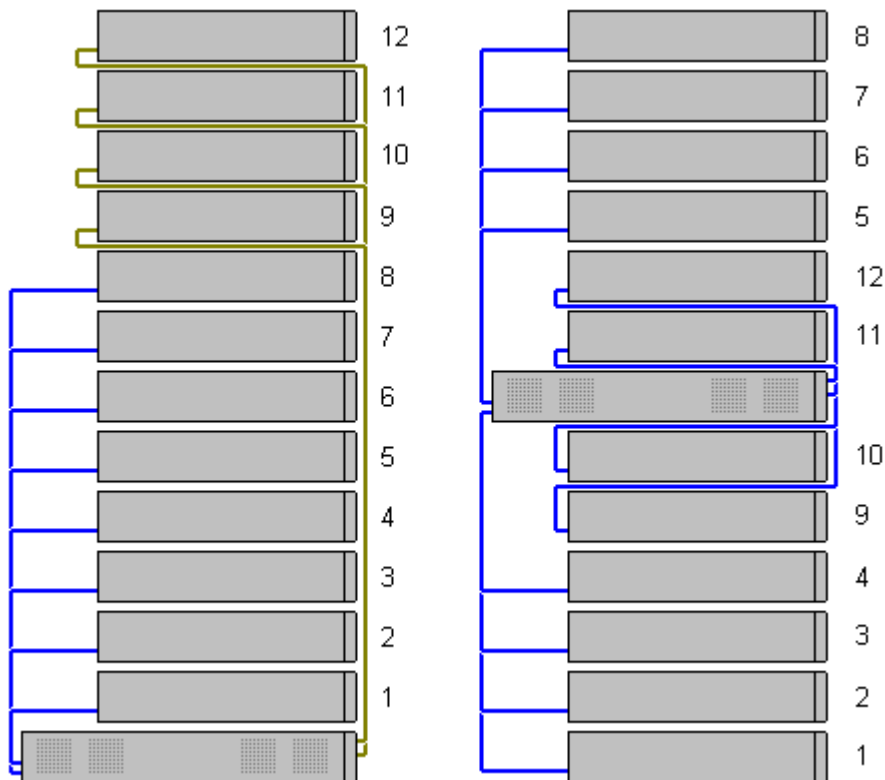



### 2.2.3 Wall Mounting

IP500 V2 control units and IP500 external expansion modules can be wall or rack mounted. To do this, a wall mounting kit is required in addition to suitable wall fixings.

In addition to the existing [environmental requirements](#)<sup>53)</sup> for an IP Office system, the following additional requirements apply when wall mounting a unit:

- The wall surface must be vertical, flat and vibration free. Attachment to temporary walls is not supported.
- Only the screws provided with the mounting kit should be used to attach the brackets to the control unit.

The following wall and rack mounting kit is currently available:

- **IPO IP500 RACK MNTG KIT V3** (SAP Code 700503160)

These kits can be used for wall and rack mounting of an IP500 V2 control unit and IP500 external expansion modules. The kits incorporates cable routing at the front and rear of the unit. For wall mounted control units it allows orientation of the control unit base card slots to the left or to the right.

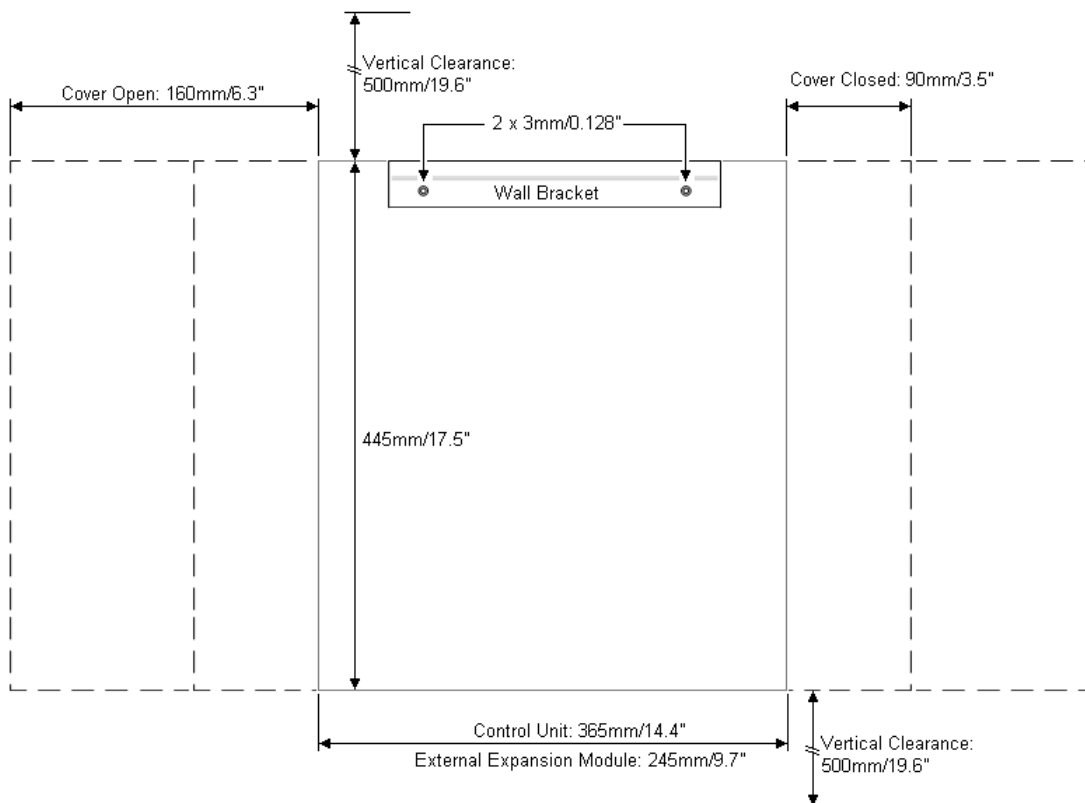
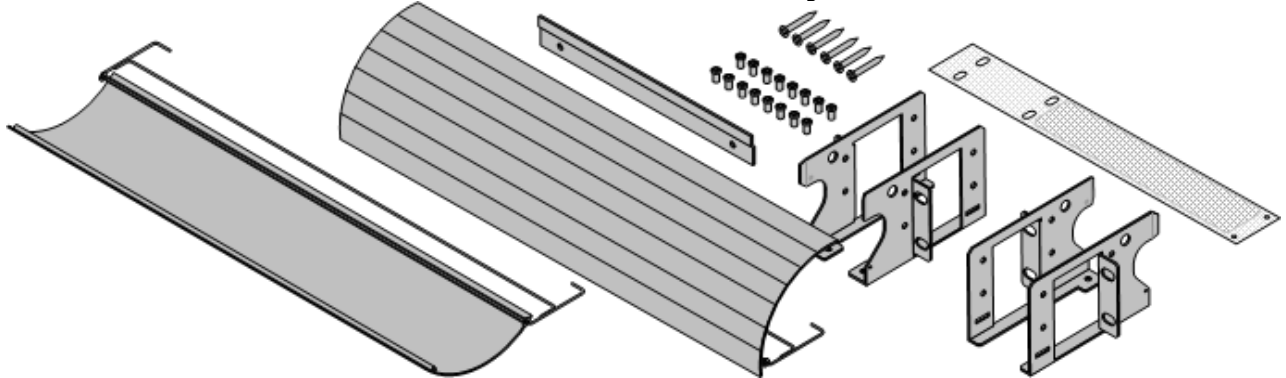

## 2.2.4 Rack Space Requirements

All IP Office control units and external expansion modules can be rack mounted into standard 19" rack systems. Each unit requires a 2U slot space within the rack. The IPO IP500 RACK MNTG KIT V3 is used for rack mounting of units.

Where IP Office systems are being rack mounted, the effect of conditions within the rack cabinet must be considered. For example the rack temperature may be above the room temperature and airflow within the rack will be restricted. The [environmental requirements](#)<sup>[53]</sup> for the individual IP Office units are still applicable inside the rack cabinet.

### Barrier Box Rack Mounting Kit

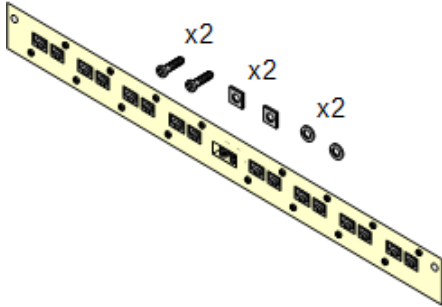

- **Barrier Box Rack Mounting Kit** (SAP 700293905)

Barrier boxes must be used for [out-of-building analog phone extensions](#)<sup>[36]</sup>. This bracket allows up to 8 IP Office barrier boxes to be rack mounted and simplifies the number of connections to the protective ground point in the rack. This kit must be used when more than 3 barrier boxes are in use and supports a maximum of 16 barrier boxes for a single external expansion module.

### Rack Module Positioning

The integral expansion ports on a control unit are located on the rear of the unit. For IP500 V2 control units, an additional 4 expansion ports can be added to the front of the control unit by installing an IP500 4-Port Expansion card.

- Each external expansion module is supplied with a blue 1 meter (3'3") expansion interconnect cable. This cable must be used when connecting to expansion ports on the rear of a control unit.
- When connecting to expansion ports on an IP500 4-Port Expansion card, a yellow 2 meter (6'6") expansion interconnect cable can be used in place of the standard blue cable. 4 Yellow cables are supplied with the IP500 4-Port Expansion card.

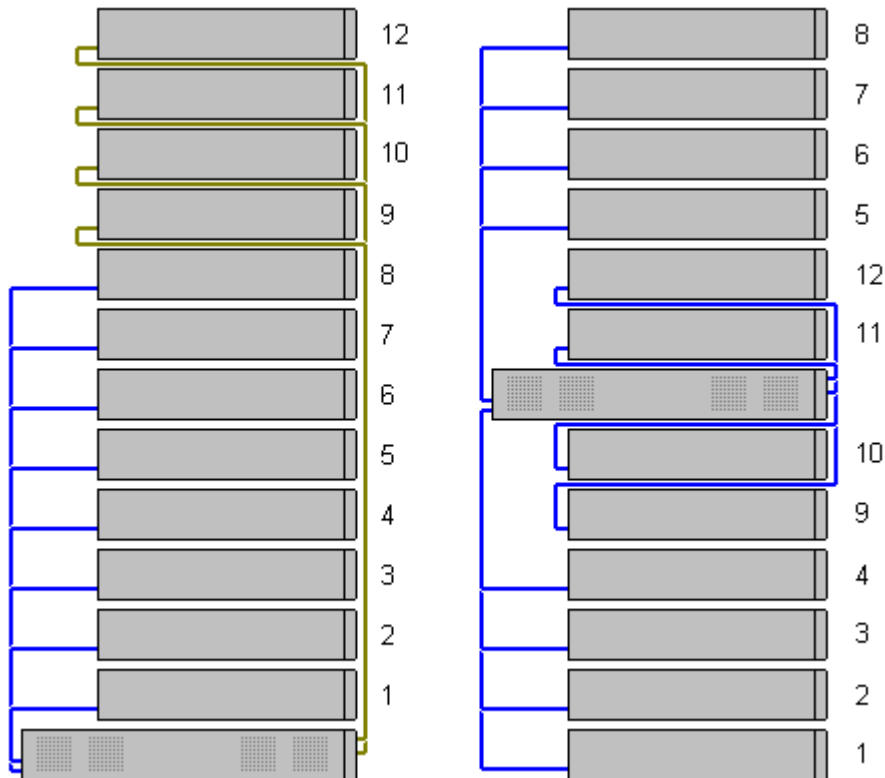

## 2.3 Tools and Equipment Required



The following is a general summary of the tools required. Additional tools and equipment will be required for wall and or rack mounting and to fashion ground cable connections suitable to local requirements.

- **Tools Required**

- 5mm Flat-blade screwdriver.
- Crosshead screwdriver.
- Anti-static wrist strap and ground point.
- RJ45-RJ45 Ethernet LAN Cable.
- M4 Cross-Head Screwdriver.
- Tools suitable for crimping a cable spade.
- If wall mounting, drills and tools for wall mounting fixtures.

- **Additional Parts Required**

In addition to orderable IP Office equipment, the following items will be required.

- 14AWG Solid copper wire for ground connection of control units and expansion modules.
- Cable sleeve matching local regulator requirements for ground wires. Typically green for a functional ground and green/yellow for a protective ground.
- If wall mounting, additional fixtures and fittings suitable for the wall type and mounting kit being used.
- Cable ties and labels for tidying and identifying cables.

- **System Administration**

1.  Selected method for system administration:
  - [Windows PC with IP Office Admin suite installed](#) <sup>66</sup> and RJ45 Ethernet LAN port.
2.  SD Card reader.

---

## 2.4 Documentation

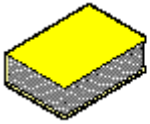

Ensure that you have read this manual in full before starting installation. Also include the installation documentation for any other equipment and applications being installed as part of the IP Office system.

- **! IP Office Technical Bulletins**

You must obtain and read the IP Office Technical Bulletin relating to the IP Office software release which intend to install. The bulletin contains important information that may not have been included in this manual. IP Office Technical Bulletins are available from the [Avaya support](http://support.avaya.com) website (<http://support.avaya.com>).

- **! Upgrade Licenses**

Some upgrades may require entry of upgrade licenses. It is still possible to upgrade the system without the necessary licenses, however the system will not provide any telephony functions after the upgrade until the appropriate license is added to the system configuration.

- **Avaya IP Office Platform Security Guidelines**
- **one-X Portal for IP Office Installation.**
- **Avaya H323 IP Phone Installation.**
- **Embedded Voicemail Installation.**
- **Voicemail Pro Installation.**
- **Contact Store Installation.**
- **Compact DECT Installation.**
- **IP DECT R4 Installation.**
- **3600 Series Wireless IP Installation.**
- **SoftConsole Installation Manual.**
- **SIP Extension Configuration.**
- **1100/1200 Series Phone Installation.**

### Information Web Sites

IP Office documentation is available from the following web sites.

- **Avaya Support** (<http://support.avaya.com>)  
Contains documentation and other support materials for Avaya products including IP Office. Copies of the IP Office CD images are available from this site and updated core software .bin files.
- **Avaya IP Office Knowledge Base** (<http://marketingtools.avaya.com/knowledgebase>)  
Access to an on-line regularly updated version of the IP Office Knowledge Base.

## 2.5 Unpacking

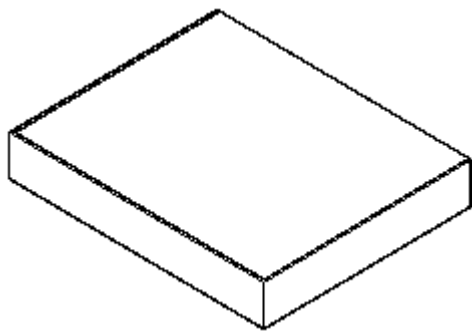

Use the following procedure when unpacking any equipment supplied by Avaya or an Avaya reseller or distributor.

### Information Required

- **Equipment Checklist.**  
An installation checklist of the parts and equipment ordered for the installation.

### Procedure

1.  **Check for Packaging Damage**  
Before unpacking any equipment, check for any signs of damage that may have occurred during transit. If any damage exists bring it to the attention of the carrier.
2.  **Check the Correct Parts Have Been Delivered**  
Check all cartons against the packing slip and ensure that you have the correct items. Report any errors or omissions to the equipment supplier.
3.  **Retain All Packaging and Documentation**  
While unpacking the equipment, retain all the packaging material. Fault returns are accepted only if repackaged in the original packaging. If performing a staged installation, the original packaging will also assist when repacking equipment to be moved to the final install site.
4.  **Ensure that Anti-Static Protection Measures are Observed**  
Ensure that anti-static protection measures are observed at all times when handling equipment with exposed electrical circuit boards.
5.  **Check All Parts**  
Visually inspect each item and check that all the necessary documentation and accessory items have been included. Report any errors or omissions to the dealer who supplied the equipment.
6.  **Check All Documentation**  
Ensure that you read and retain any documentation included with the equipment.



# Chapter 3.

## Installing the Admin Software

---

## 3. Installing the Admin Software

In order to install and maintain an IP Office system you must be familiar with using the following applications.

- **IP Office Manager**

This is a Windows based application. IP Office Manager is used to access all parts of the IP Office configuration. Different levels of access can be defined to control which parts of the configuration the user can view and alter. IP Office Manager is also used to upgrade the software files used by an IP Office system.

- **IP Office Web Manager**

The configuration for an IP500 V2 system can be accessed via web browser using the same service user accounts as used for IP Office Manager. Currently, for IP Office standard mode systems, IP Office Web Manager can only be used to configure groups, users and service users (security accounts) and to perform basic maintenance actions. Therefore, IP Office Manager is still required for full system installation and maintenance.

- **System Status Application**

The System Status Application (SSA) is a reporting tool that provides a wide range of information about the current status of an IP Office system. It can report the available resources and components within the system and details of calls in progress. Details of the number of alarms are recorded and the time date of the most recent alarms. When required for diagnostics escalation, SSA is able to take a snap shot image of the IP Office system's status including a copy of its current configuration. Use of SSA requires an IP Office service user name and password that has been configured for System Status access in the IP Office's security settings.

- **Monitor (System Monitor)**

System Monitor is a tool that can show all activity on the IP Office system in great detail. As a consequence, interpretation of Monitor traces requires a high-level of data and telephony protocol knowledge. However, all IP Office installers and maintainers must understand how to run Monitor when necessary as Avaya may request copies of Monitor traces to resolve support issues.

### 3.1 Downloading the Software

The IP Office administration suite of software is available as an [orderable DVD](#)<sup>[44]</sup>. However, the software can also be downloaded from the Avaya support website (<http://support.avaya.com>).

- **IP Office Manager Version**

It is important to download and install the correct version of the IP Office administration suite including IP Office Manager.

- For system installation, you should use the version of IP Office Manager that matches the IP Office release required on the system. The sets the version of IP Office software loaded when [recreating the System SD card](#)<sup>[75]</sup>.
- For system maintenance, the version of IP Office Manager used sets the version of IP Office software uploaded to a system when [upgrading the system](#)<sup>[164]</sup>.
- For system configuration IP Office Manager is backward compatible. IP Office Manager Version 9.1 is backwards compatible for configuring systems running software from IP Office Release 6.0 upwards. IP Office Manager cannot load the configuration of an IP Office system running a higher version of software.

- **! IP Office Technical Bulletins**

You must obtain and read the IP Office Technical Bulletin relating to the IP Office software release which intend to install. The bulletin contains important information that may not have been included in this manual. IP Office Technical Bulletins are available from the [Avaya support](#) website (<http://support.avaya.com>).

- **! Upgrade Licenses**

Some upgrades may require entry of upgrade licenses. It is still possible to upgrade the system without the necessary licenses, however the system will not provide any telephony functions after the upgrade until the appropriate license is added to the system configuration.

#### To download Avaya software:

1. Browse to <http://support.avaya.com> and log in.
2. Select **Support by Product** and click **Downloads**.
3. Enter **IP Office** in the **Enter Product Name** box and select the matching option from the displayed list.
4. Use the **Choose Release** drop-down to select the required IP Office release.
5. Click **Downloads**. The page lists the most recently available downloads.
6. Click **View Downloads** for the full list of downloads.
7. Select the required software package for download.
8. The page displayed in a new tab or windows details the options for downloading that software. For IP500 installation, download the full administration package, not the separate binary files or the Admin lite download packages.
9. Also download the documents listed under the **RELATED DOCUMENTS** heading if shown.





---

## 3.2 Installing the Admin Applications

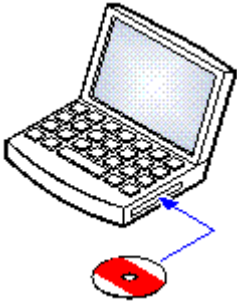

The IP Office Administration suite consists of a number of applications for IP Office installers and maintainers.

- **System Monitor** - *Install* ✓
- **Manager** - *Install* ✓
- **System Status Application** - *Install* ✓
- **Call Status** - *Optional*

This software is not supported with IP Office Release 7.0 and higher systems. It is provided only for the maintenance of older systems.

### Requirements

- **IP Office Release 9.1 User/Admin DVD Set (2) (700506051)**

Alternatively the IP Office Administrator Applications suite can be downloaded from [Avaya's support website](http://support.avaya.com) (<http://support.avaya.com>).

- **Windows PC Requirements**

The specification below are the minimum requirements for IP Office Manager. If other applications are to be installed on the PC then their individual requirements should also be met. The supported versions of Windows are listed in the [Operating Systems](#) <sup>(350)</sup> section.

- **Standard Manager:** Core i3 CPU, 4GB RAM, 32/64 bit OS
- **Server Edition Manager:** Core i5 CPU, 6GB RAM , 32/64 bit OS
- **Server Edition Select Manager:** Core i5 CPU, 8GB RAM, 64 bit OS

**To install the IP Office administrator applications:**

1. Using the **Add or Remove Programs** option in the Windows Control Panel, check that the PC does not already have a version of the IP Office Admin suite installed.
  - If 'yes' and the suite is a pre-IP Office 3.2 version, remove the existing IP Office Admin suite via Add/Remove Programs.
  - If the existing suite is IP Office 3.2 or higher, it is possible to upgrade without removing the previous installation.
2. Insert the IP Office Administrator Applications DVD. Select the option for the IP Office Administration Suit. A folder window will display the installation files for the administration suite.
3. For Windows 7, right-click on setup.exe and select **Run as administrator**. Otherwise, double-click on **setup.exe**.
4. Select the language you want to use for the installation process. This does not affect the language used by IP Office Manager when running. Click **Next >**.
5. Select who should be able to run the Admin Suite applications. Click **Next >**.
6. If required select the destination to which the applications should be installed. We recommend that you accept the default destination. Click **Next >**.
7. The next screen is used to select which applications in the suite should be installed. Clicking on each will display a description of the application. Click on the ▼ next to each application to change the installation selection. When you have selected the installations required, click **Next >**.

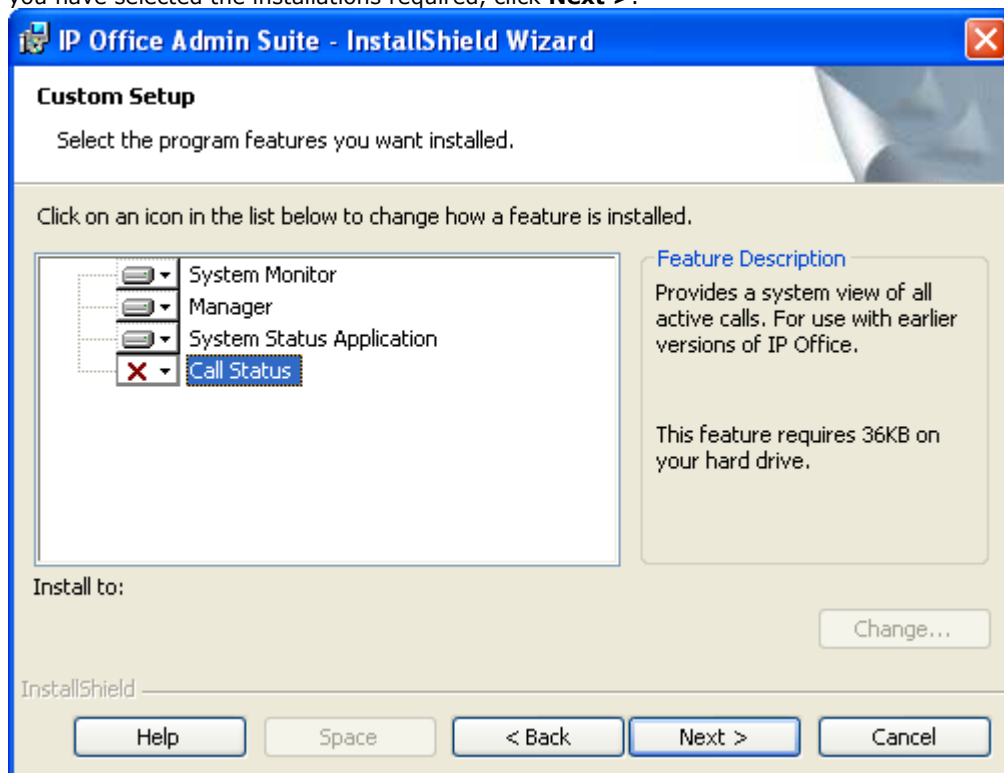

8. Ensure that at minimum **System Monitor** and **Manager** are selected. Click **Next >**.
9. Click **Install**.
10. Installation of Windows .Net2 components may be required. If dialogs for this appear, follow the prompts to install .Net.
11. If requested, reboot the PC.

### 3.3 Installer PC Connection

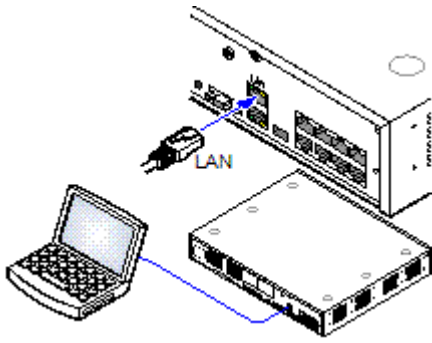

During installation it is recommended that the IP Office control unit is started without it being connected to any network. That ensures that the IP Office defaults to a known set of IP address settings.

If the IP Office is started connected to a network with a DHCP server, the programming PC will need to be connected to the same network as either a DHCP client or with an IP address valid for that network.

This section covers connecting your installation PC directly to the IP Office control unit.

#### Requirements

- **IP Office Administration PC**  
A Windows PC with the [IP Office Administrator Application suite installed](#) [66].
- **LAN Cable**

#### To connect directly to a defaulted IP Office system:

1. The default address for an IP Office control unit LAN port is 192.168.42.1/255.255.255.0. To directly connect a PC, change the TCP/IP properties for the PCs LAN port to the following:

<b>Fixed IP address</b>	192.168.42.203
<b>Subnet mask</b>	255.255.255.0
<b>Default gateway</b>	192.168.42.1.

- While setting the PC to be a DHCP client could be used, this is not recommended for performing more advanced functions such as firmware upgrades.
2. Connect the LAN cable from the PCs LAN port the LAN or LAN1 port on the IP Office control unit.
  3. Check that the orange LED lamp on the IP Office LAN port is on. The green LED may also be flickering as it indicates traffic across the LAN connection.
  4. To test the connection before running IP Office Manager or System Status Application:
    - Select **Start | Run** and enter **cmd**.
    - In the command window that appears enter ping **192.168.42.1**. The results should show a number of ping replies from the IP Office. This confirms basic communication between the IP Office Manager PC and the IP Office.
    - If there are no ping replies enter **ipconfig**. The results should list the IP address settings of the IP Office Manager PC as required above. If they do enter **exit** and check the cable connection.
  5. You can now start [IP Office Manager](#) [69], [System Status](#) [70] or [System Monitor](#) [71].

## 3.4 Starting IP Office Manager

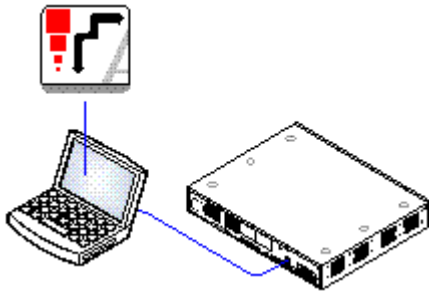

IP Office Manager is used to access all parts of the IP Office configuration. IP Office Manager can also be used to upgrade the software files used by an IP Office system.

- **IP Office Manager Version**

It is important to download and install the correct version of the IP Office administration suite including IP Office Manager.

- For system installation, you should use the version of IP Office Manager that matches the IP Office release required on the system. The sets the version of IP Office software loaded when [recreating the System SD card](#) <sup>[75]</sup>.
- For system maintenance, the version of IP Office Manager used sets the version of IP Office software uploaded to a system when [upgrading the system](#) <sup>[164]</sup>.
- For system configuration IP Office Manager is backward compatible. IP Office Manager Version 9.1 is backwards compatible for configuring systems running software from IP Office Release 6.0 upwards. IP Office Manager cannot load the configuration of an IP Office system running a higher version of software.

### Requirements

- **IP Office Administration PC**

A Windows PC with the [IP Office Administrator Application suite installed](#) <sup>[66]</sup>.

- **LAN Cable**

### To start IP Office Manager:

1. Select **Start | Programs | IP Office | Manager**.
2. If the PC has firewall software installed, you may be prompted as to whether you want to allow this program to access the network. Select **Yes** or **OK**.
3. Select **File | Open Configuration** from the menu bar.
4. The **Select IP Office** window appears. After a few seconds it should list the IP Office control unit. The default display name used for a newly installed IP Office control unit is its MAC address.

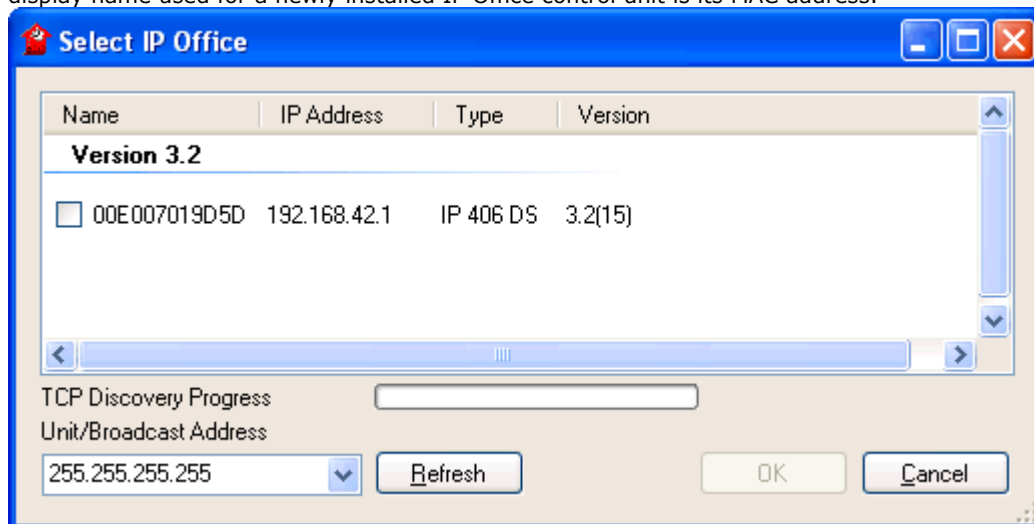

- If the system required was not found, the address used for the search can be changed. Enter or select the required address in the **Unit/Broadcast Address** field and then click **Refresh** to perform a new search.
5. Click the check the box next to the system and then click **OK**.
  6. The name and password request is displayed. The name and password must match one of those setup through the security settings.

## 3.5 Starting System Status Application

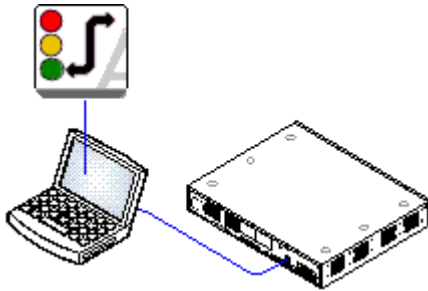

The System Status Application (SSA) is a reporting tool that provides a wide range of information about the current status of an IP Office system. It can report the available resources and components within the system and details of calls in progress. Details of the number of alarms are recorded and the time date of the most recent alarms.

When required for diagnostics escalation, SSA is able to take a snap shot image of the IP Office system's status including a copy of its current configuration. Use of SSA requires an IP Office service user name and password that has been configured for System Status access in the IP Office's security settings.

### To start System Status:

1. There are several methods that can be used to start the System Status Application.

- On a PC where [System Status has been installed](#), select **Start | Programs | IP Office | System Status**.
- If IP Office Manager is also installed on the PC and is running, select **File | Advanced | System Status**.
- For IP500 V2 controls units, start a web browser and enter the IP address of the control unit. Select the link for the **System Status**.

2. Once System Status has started, it will request the details of the IP Office system to which you want it to connect.

- **Control Unit IP Address**  
Enter the IP address of the IP Office control units LAN interface or use the drop down to select a previously used address.
- **Services Base TCP Port**  
This should match the Services Base TCP Port setting of the IP Office system, set in that systems security settings. The default is 50804.
- **Local IP Address**  
If the PC has more than one IP address assigned to its network card or multiple network cards, the address to use can be selected if necessary.
- **User Name/Password**  
Enter a user name and password that has been provided for System Status usage. By default this is the same as the user name and password used with IP Office Manager. This must be the name of an IP Office service user name that has been configured for system status access in the IP Office's security settings.
- **Auto Reconnect**  
If selected, System Status will attempt to reconnect using the same settings if connection to the IP Office is lost.

3. Enter the required details for the IP Office and click **Logon**.

## 3.6 Starting System Monitor

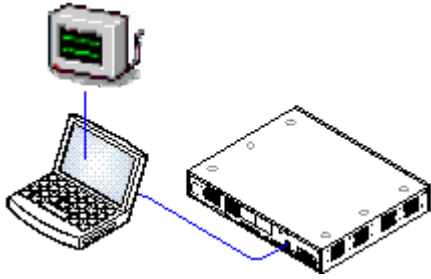

System Monitor is a tool that can show all activity on the IP Office system in great detail. As a consequence, interpretation of Monitor traces requires a high-level of data and telephony protocol knowledge. However, all IP Office installers and maintainers must understand how to run Monitor when necessary as Avaya may request copies of Monitor traces to resolve support issues.

### Requirements

- **IP Office Administration PC**  
A Windows PC with the [IP Office Administrator Application suite installed](#) [66].
- **LAN Cable**

### 1. To start System Monitor:

1. Select **Start | Programs | IP Office | System Monitor**.
2. If System Monitor has run before, it automatically attempts to connect with the system that was previously being monitored. If otherwise or you want to monitor a different system, use the steps below to select the required system.
3. Select **File** and then **Select Unit**.

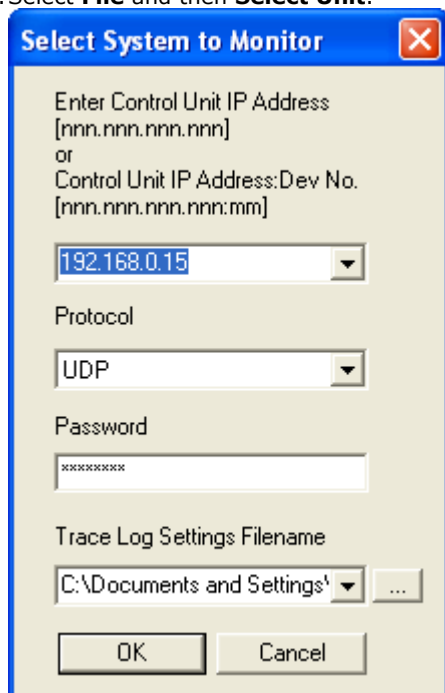

4. Enter the **IP Address** and **Password** of the system that you want to monitor.

- **Protocol**

The default Protocol for System Monitor operation is **UDP**. This reduces the impact on the system of sending records, especially when a large number of records are being sent. The **TCP** is only supported when connecting to system running the IP Office Release 9.0 or higher. Using the TCP protocol to connect to pre-9.0 systems can cause packet congestion on the IP Office and affect services. In order to use System Monitor remotely through Avaya SAL, select **TCP**.

- **Which Password?**

Using IP Office Manager, it is possible to set a specific **Monitor Password**. If the system does not have a **Monitor Password** set, System Monitor uses the system's **System Password**. The **Monitor Password** and **System Password** are set within a system's security configuration settings.

5. If you want System Monitor to start with a previously saved set of trace options, use the **Trace Log Settings Filename** browse button to select the trace options settings file.
6. Click **OK**.

---

## 3.7 IP Office Web Manager

Web browser access to the system can be used to run IP Office Web Manager. Enter the system's IP address and then select the **IP Office Web Management** link.

For system's running in IP Office standard mode, IP Office Web Manager is currently used only for maintenance actions (shutdown, reboot, upgrade, etc) and configuration of users and hunt groups. For full details, refer to the IP Office Web Manager Manual. It does not allow access to the minimum configuration settings expected for initial system installation and so it not covered in this document.



# Chapter 4.

## Preparing the System SD Card

---

## 4. Preparing the System SD Card

New IP500 V2 control units are supplied with no installed firmware or configuration. When first powered up, the control unit loads and installs the necessary firmware from the **System SD** card installed in the control unit. It then creates a default configuration matching the physical cards already installed in the control unit and any external expansion modules already attached to it.

- **! WARNING: Installing PCS14 and earlier control units**

[PCS](#)<sup>[388]</sup> 14 or lower units must first install Release 8.1(65) (or higher 8.1) or any Release 9.0 and then upgrade to Release 9.1. Care should be taken to ensure that no calls are made before the upgrade to Release 9.1, otherwise the system will require an 9.1 upgrade license despite being "new". The PCS of the control unit is printed on the label on the back of the control unit.

You can perform a number of additional actions prior to installing the System SD card in order to pre-configure the system. These can greatly speed up the physical installation at the customer site as they can all be done in advance.

- [Upgrade the Card Firmware](#)<sup>[75]</sup>
- [Add a Configuration File](#)<sup>[77]</sup>
- [Add a License File](#)<sup>[77]</sup>
- [Adding Security Certificates](#)<sup>[77]</sup>
- [Add a 9600 Screen Saver Image File](#)<sup>[78]</sup>
- [Add Music on Hold Files](#)<sup>[78]</sup>

Additional actions that can be performed on SD cards are detailed in the [SD Card Management](#)<sup>[122]</sup> section.

## 4.1 Upgrade the Card Firmware

This command can be used with a read-writeable SD card on the IP Office Manager PC. It copies the files and folders used by an IP500 V2 system when starting. It updates the card with the version of those files installed with the IP Office Manager application. It includes the binary files for the IP500 V2 system, external expansion modules and phones. It also includes the prompt files for Embedded Voicemail operation.

- **! WARNING: Installing PCS14 and earlier control units**

[PCS](#) 14 or lower units must first install Release 8.1(65) (or higher 8.1) or any Release 9.0 and then upgrade to Release 9.1. Care should be taken to ensure that no calls are made before the upgrade to Release 9.1, otherwise the system will require an 9.1 upgrade license despite being "new". The PCS of the control unit is printed on the label on the back of the control unit.

This process replaces existing files and adds new files. It does not delete files, so for example, any existing Embedded Voicemail messages and greetings are retained. If the card contains dynamic system files such as SMDR records, they are temporarily backed up by IP Office Manager and then restored after the card is recreated.

For the card to be used in an IP500 V2 system's **System SD** slot the card must be Avaya System SD card. The card must be correctly formatted, however a reformat of an existing working card is not necessary before using recreate to update the card contents.

- The source for the files copied to the SD card are the sub-folders of the **\Memory Cards** folder under Manager's applications **Working Directory** (normally **C:\Program Files Avaya\IP Office\Manager**). However, if the Working Directory is changed to a location without an appropriate set of **\Memory Cards** sub-folders, the required set of files will not be copied onto the SD card.

### To upgrade a System SD card

1. Once started do not interrupt this process, for example by removing the SD card. This process takes approximately 15 minutes.
2. Insert the SD card into a card reader on the IP Office Manager PC.
3. Using IP Office Manager, select **File | Advanced | Recreate IP Office SD Card**.
4. Select **IP Office A-Law**, **IP Office U-Law**, **IP Office Partner Edition**, or **IP Office Norstar Edition**. This selection will affect how the IP Office systems operates when defaulted with this card present in its **System SD** card slot.
5. Browse to the card location and click **OK**.
6. IP Office Manager will prompt whether you want to include Avaya IP Office Web Manager files as part of the recreate process. Those files are necessary if you want to run IP Office Web Manager to manage the IP Office system into which the card will be loaded or if you want to use [on-boarding](#).
7. IP Office Manager will start creating folders on the SD card and copying the required files into those folders. This process will take approximately 15 minutes.
8. Do not remove the SD card during the process. Wait until the IP Office Manager displays a message.

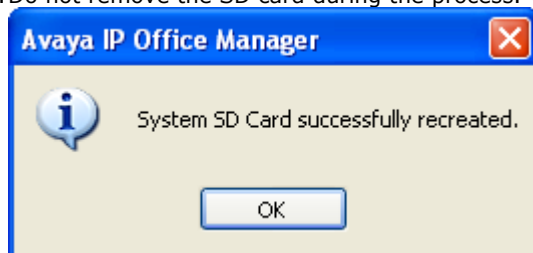

## 4.2 Creating an Offline Configuration File

IP Office Manager can be used to create a new configuration without connecting to an IP Office system. During the process, you can specify the locale of the system, what type of trunk cards it uses and what type of control unit and expansion modules to include.

This allows the creation of a configuration prior to installation of system. The configuration file can be placed onto the System SD card before it is installed into the system. Otherwise the configuration can be uploaded to the system after initial installation of the system.

- The configuration created must match the physical equipment in the IP Office system onto which the configuration will be loaded. Doing otherwise may cause the IP Office system to reset and experience other problems.

### To create an offline configuration file

1. Start IP Office Manager with no configuration loaded into IP Office Manager
2. Select **File | Create an Offline Configuration**.

Slot	Extension/VCM	Trunk
1	None	None
2	None	None
3	None	None
4	None	None

3. Select the type of configuration that you want to create. The equipment and settings are restricted to those supported in the selected mode.
4. When completed click **OK**.
5. IP Office Manager creates and loads the configuration.
6. Edit the configuration to match the customer requirements. This can include importing information from prepared CSV files.
7. When completed, select **File | Save Configuration As**.
8. When prompted to enter a password to encrypt the file, leave the fields blank and click **OK**.

Enter a password to encrypt the file or leave empty to save unencrypted.

Enter Password (Minimum 8 characters)

Re-enter password (For confirmation)

OK Cancel Help

## 4.3 Adding a Pre-Built Configuration File

IP Office Manager can be used to [create an offline configuration file](#)<sup>[76]</sup>. For IP500 V2 control units, such a pre-created IP Office configuration file can be placed on the System SD card. That file is then loaded when the new IP Office system is started.

### To load a pre-built offline configuration onto a System SD card

1. Using IP Office, create an offline configuration that matches the customer requirements and the equipment that will be installed in the IP Office.
2. Rename the configuration file **config.cfg**.
3. Using a card reader, copy the file into the **/system/primary** folder on the System SD memory card.

## 4.4 Adding a License File

For IP500 V2 control units, if a licence file called **keys.txt** is found in the SD card folder which the IP Office uses when it boots, the IP Office will merge the licenses in that file with its configuration.

The files should be a plain text file (UTF8) containing either:

- A license name and license key separated by a comma on each line.
- A license key on each line.

```
Teleworker, uAuToY@9VvVV@VOzIgeegwLXL2sAs1Z5
Mobile Worker, NvWO_iVY5KJpZMNeY89IB1sIj0_QUCDm
Power User, 9IJQW3yuPsbxjGS2XcMa16_J9H8cSeZ9
System Advanced, JAWZaw@YtK37vcnXkqM4mDYDIIdSMd9_1
uAuToY@9VvVV@VOzIgeegwLXL2sAs1Z5
NvWO_iVY5KJpZMNeY89IB1sIj0_QUCDm
9IJQW3yuPsbxjGS2XcMa16_J9H8cSeZ9
JAWZaw@YtK37vcnXkqM4mDYDIIdSMd9_1
```

### To load a License File onto a system SD card

1. Using a card reader, copy the file into the **/system/primary** folder on the System SD memory card.

## 4.5 Adding Security Certificates

The IP Office system can use security certificates to validate the connections between itself, applications and other IP Office systems. Certificates can also be used for IP telephony communications.

Certificates can be placed onto the System SD card. Those certificates are then loaded into the system's certificate store when the system is started. The certificate file name extension must indicate the type of encoding; PEM encoded files should end with **.pem**, DER encoded files should end with **.der**.

### To load a certificate to add:

1. Using a card reader, copy the file into the **/system/primary/certificates/tcs/add** folder on the System SD memory card.

### To load a certificate to remove:

The mechanism above can adapted to also remove an existing certificate.

1. Using a card reader, copy the file into the **/system/primary/certificates/tcs/remove** folder on the System SD memory card. If the matching certificate already exists in the system certificate store, that certificate is removed.

## 4.6 Adding a 9600 Series Screen Saver File

When idle, 9600 Series phones can timeout to displaying a screen saver image. A file, **96xxiposs.jpg**, is present on the cards by default.

You can replace this file with your own branded file. The file should be smaller than the screen size on 9600 Series phones in order to then be moved around the screen.

Phone	Maximum Size	Phone	Maximum Size	Phone	Maximum Size
9611	160x160	9621G	320x160	9650	320x240
9620	320x160	9630	320x240	9650C	320x240
9620L	320x160	9640	320x240		
9620C	320x160	9641G	320x240		

- Color Displays: Color depth is 16 bit. A separate color image will look best.
- Non-Color Displays: Best results are achieved with a single grayscale logo image. 2 levels of grayscale are also supported.
- To invoke transparent backgrounds with logos, use a background color of 0,255,0 (brightest possible green).

## 4.7 Adding Music on Hold Files

By default the IP Office will use internal music on hold by uploading a music file from the IP Office Manager PC. For IP500 V2 systems, you can load a file onto the System SD card prior to installing it in the IP Office.

The file must be of the following format and must be called **holdmusic.wav**.

Property	Value
File Type	WAV
Bit Rate	128kbps
Audio sample size	16 bit
Channels	1 (mono)
Audio Sample Rate	8 kHz
Audio Format	PCM
Length	Up to 90 seconds.

### To loading a music on hold file onto a System SD card

1. Rename the music file **holdmusic.wav**.
2. Using a card reader, copy the file into the **/system/primary** folder on the System SD memory card.
3. If the IP Office is or will be configured for additional hold music files (up to 3 additional files), copy those files to the same location. The name of the additional files must match those specified in the IP Office system's configuration.

# Chapter 5.

## Installing the Control Unit Cards

---

## 5. Installing the Control Unit Cards

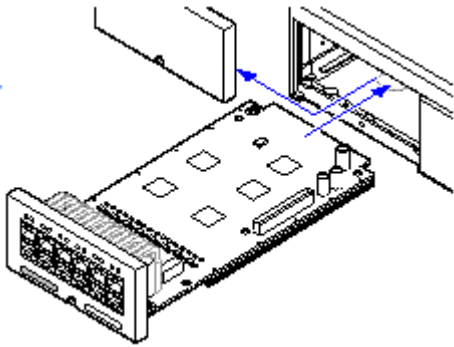

The IP500 base cards and trunk daughter cards should be fitted before power is applied to the control unit. Ensure that cards are inserted in the order that matches the planned or pre-built configuration.

This process has 2 stages:

1. [Fit the IP500 trunk daughter cards onto the IP500 base cards.](#) 81
2. [Insert the IP500 Base Cards into the Control Unit.](#) 82

- **⚠ Warnings**

- Correct anti-static protection steps should be taken before handling circuit boards.
- Cards must never be added or removed from the control unit while it has power connected.

- **General Notes**

- Cards can be fitted in any order into any available slots. The only exception is the IP500 4-Port Expansion card which can only be installed in right hand slot 4.



## 5.1 Fitting IP500 Daughter Cards

IP500 trunk daughter cards can be fitted to any IP500 base card except the Unified Communications Module and 4-Port Expansion card. For IP500 Combination cards, the trunk daughter card is pre-installed and cannot be changed.

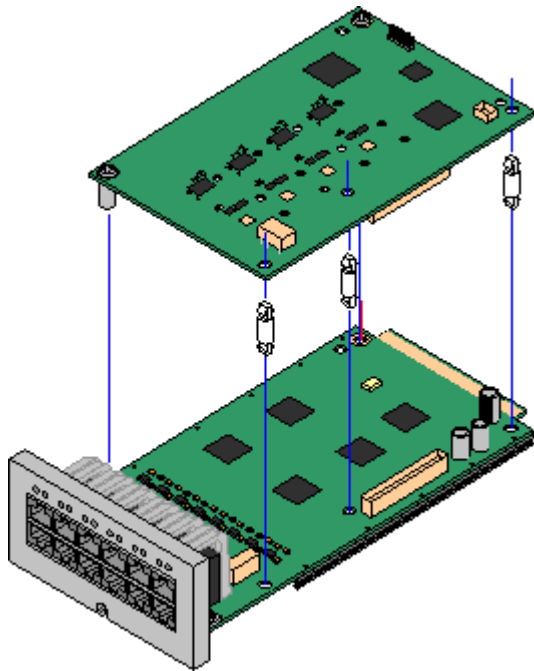

### ⚠ Warnings

1. Correct anti-static protection steps should be taken while handling circuit boards.

### Parts and Equipment Required

1.  **IP500 Base Card**
2.  **IP500 Trunk Daughter Card**
3.  **3 Stand Off Pillars**  
These are supplied with the trunk daughter card.

### Tools Required.

1.  5mm Flat-blade screwdriver.
2.  Anti-static wrist strap and ground point.

### Procedure: Installing a Trunk Daughter Card

1. Check that correct cards have been supplied.
2. Ensure that you are wearing an anti-static wrist strap connected to a suitable ground point.
3. On the base card identify the position of 3 holes for the plastic pillars for the IP500 card. These are along the same edge as the card connector.
4. Fit the stand off pillars to the IP500 base card.
5. If there is a clip-on metal shield over the connector block on the base card, remove it.
6. Using minimal force and checking that the pins are correctly located, push the IP500 trunk card onto its connector block and the stand off pillars.
7. Check that the card connector has snapped into position.
8. Using the washers and screws provided, secure the metal stand off pillars to the base card.
9. A set of labels are supplied with the trunk daughter card. Fit the appropriate label to the front of the base card.

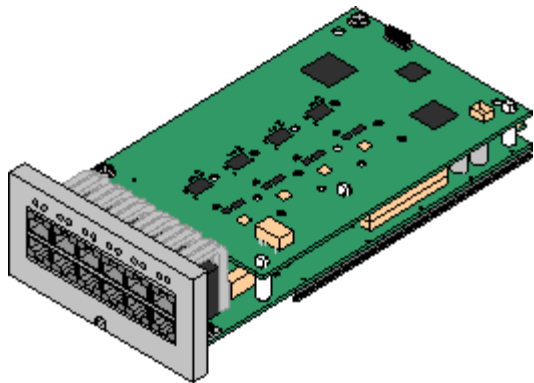

---

## 5.2 Inserting IP500 Base Cards

Having prepared each IP500 base card by adding any [trunk daughter card](#)<sup>[81]</sup>, the base card can be inserted into the control unit.

- **⚠ Warnings**

- Correct anti-static protection steps should be taken while handling circuit boards.
- Cards must never be added or removed from the control unit while it has power connected.

- **Tools Required**

- 5mm Flat-blade screwdriver.
- Anti-static wrist strap and ground point.

### Installing an IP500 Card

1. Check that there is no power to the control unit.
2. Using a flat-bladed screwdriver, remove the cover from the slot on the front of the control unit that will be used for each card being installed. This cover is no longer required but should be retained until installation has been completed.

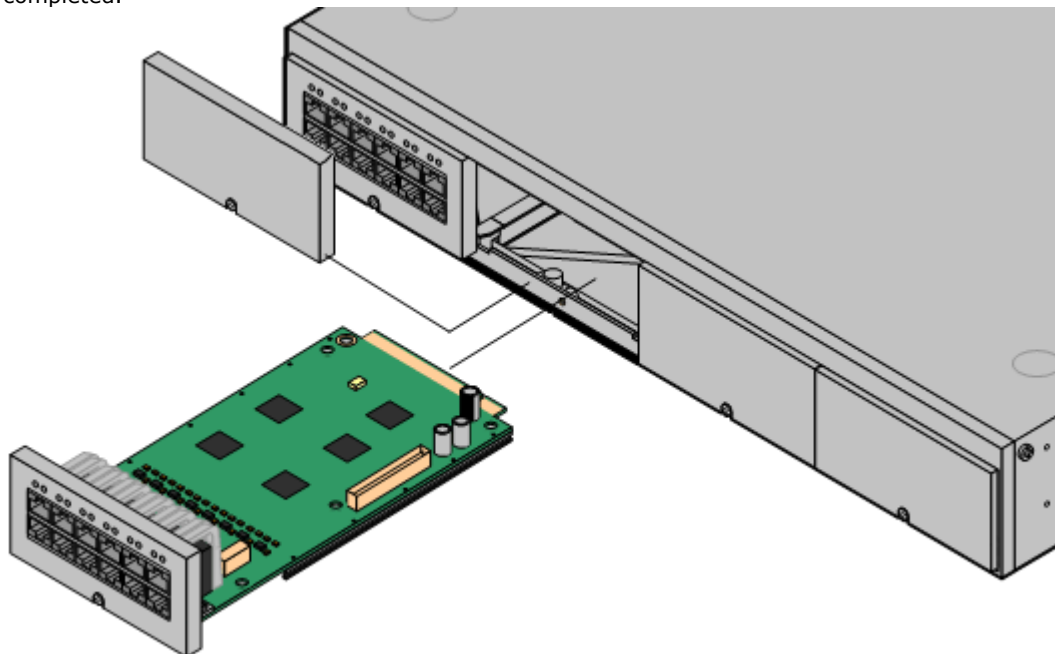

3. Allowing the card to rest against the bottom of the slot, begin sliding it into the control unit. When half inserted, check that the card rails have engaged with the slot edges by trying to gently rotate it. If the card rotates remove it and begin inserting it again.
4. The card should slide in freely until almost fully inserted. At this point apply pressure at the base of the front of the card to complete insertion.
5. Using a flat-bladed screwdriver secure the card.

# Chapter 6.

## Installing the Physical System

---

## 6. Installing the Physical System

Having prepared for installation, this section covers the basic on-site installation.

### Summary

1. [Prepare for installation](#) <sup>52</sup>
  - a. [Environmental Requirements](#) <sup>53</sup>

Check that the installation area meets the system environmental requirements.
  - b. [Space Requirements](#) <sup>54</sup>

Check that the installation area meets the system space requirements.
  - c. [Tools and Parts Required](#) <sup>59</sup>

Check that you have the tools and additional parts required.
  - d. [Documentation](#) <sup>60</sup>

Ensure that you have obtained and read all the relevant documentation.
  - e. [Unpacking](#) <sup>61</sup>

Check that all the required equipment has been delivered and that there is no damage.
2. [Admin Software Installation](#) <sup>64</sup>

For system installation you need a PC with the IP Office administrator software installed. This must include a copy of IP Office Manager that matches the IP Office software level required.

  - a. [Downloading the Software](#) <sup>64</sup>
  - b. [Installing the Administrator Applications](#) <sup>66</sup>
3. [Preparing the System SD card](#) <sup>74</sup>

Upgrade the System SD card to the required releaser of IP Office software. In addition add any other files available such as the license file, pre-built configuration, music-on-hold file.

  - **! WARNING: Installing PCS14 and earlier control units**

[PCS](#) <sup>388</sup> 14 or lower units must first install Release 8.1(65) (or higher 8.1) or any Release 9.0 and then upgrade to Release 9.1. Care should be taken to ensure that no calls are made before the upgrade to Release 9.1, otherwise the system will require an 9.1 upgrade license despite being "new". The PCS of the control unit is printed on the label on the back of the control unit.
4. [Install the control unit cards](#) <sup>80</sup>

Attach any trunk daughter cards to their IP500 base cards and insert the base cards into the control unit.
5. [Install the system](#) <sup>84</sup>
  - a. [Wall Mounting](#) <sup>85</sup>

If wall mounting, attach the brackets and fit the unit to the wall.
  - b. [Rack Mounting](#) <sup>87</sup>

If rack mounting, attach the brackets and fit the control unit into the rack.
  - c. [Connect the External Expansion Modules](#) <sup>88</sup>

Connect the external expansions modules to the control unit.
  - d. [Ground the system](#) <sup>90</sup>

Attach required ground cables to the control unit and external expansion modules.
  - e. [LAN Network Connections](#) <sup>91</sup>

Attach the control unit and a PC with IP Office Manager to the LAN network.
  - f. [Starting the System](#) <sup>92</sup>

Insert the System SD card and power up the system.
  - g. [Connecting Phones](#) <sup>95</sup>

Connect the Avaya digital phones.
6. [Initial configuration](#) <sup>98</sup>

Start basic configuration of the system using IP Office Manager.
7. [Securing the system](#) <sup>114</sup>

Change any default passwords and disable unneeded services.

## 6.1 Wall Mounting

IP500 V2 control units and IP500 external expansion modules can be wall or rack mounted. To do this, a wall mounting kit is required in addition to suitable wall fixings.

In addition to the existing [environmental requirements](#)<sup>53</sup> for an IP Office system, the following additional requirements apply when wall mounting a unit:

- The wall surface must be vertical, flat and vibration free. Attachment to temporary walls is not supported.
- Only the screws provided with the mounting kit should be used to attach the brackets to the control unit.

The following wall and rack mounting kit is currently available:

- **IPO IP500 RACK MNTG KIT V3** (SAP Code 700503160)

These kits can be used for wall and rack mounting of an IP500 V2 control unit and IP500 external expansion modules. The kits incorporate cable routing at the front and rear of the unit. For wall mounted control units it allows orientation of the control unit base card slots to the left or to the right.

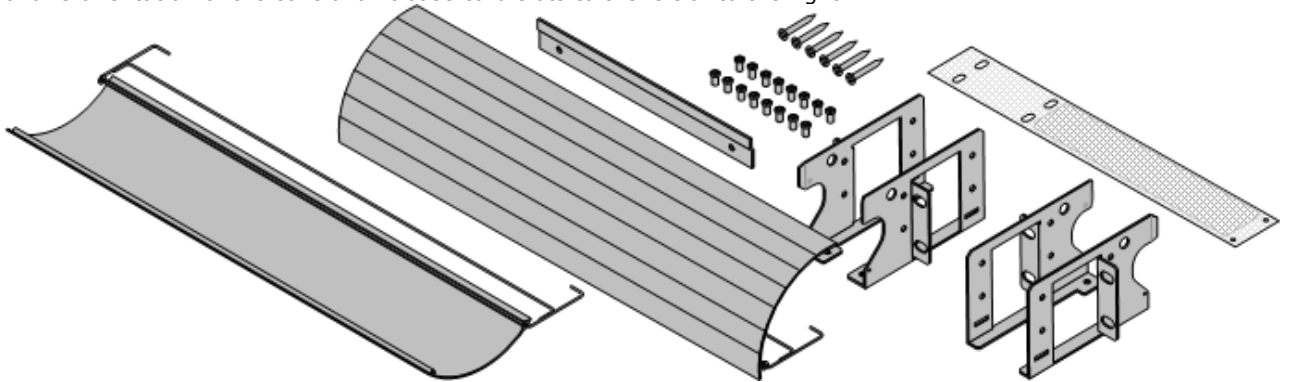

## 6.1.1 Wall Mounting Kit V2/V3

These notes relate to the **IPO IP500 RACK MNTG KIT V2** (SAP 700500923) and **IPO IP500 RACK MNTG KIT V3** (SAP 700503160). These kits can be used to wall or rack mount IP500 V2 control units and IP500 external expansion modules.

The kits includes all components necessary for wall mounting onto a plywood surface. The use of the cable covers is optional.

In addition to the existing [environmental requirements](#) <sup>(53)</sup> for an IP Office system, the following additional requirements apply when wall mounting a unit:

- The wall surface must be vertical, flat and vibration free. Attachment to temporary walls is not supported.
- Only the screws provided with the mounting kit should used to attach the brackets to the control unit.
- The installation must be done by a service person only.
- For control units, the mesh flame screen must be installed on the bottom edge of the control unit before mounting.
  - For the V3 kit, the flame screen attaches to the outside of the control unit.
  - For the V2 kit, the flame screen is inserted inside the control unit chassis. To do this you must wait at least 15 minutes after removing the power cord before fitting the flame screen.
- Ensure that the system has been shutdown and power has been removed from all the units. Shutdown the system using a shutdown command and then remove power. Do not simply remove the power.
- A suitable mounting surface of at least 19mm (0.75 inch) plywood is required.
- Full installation instructions are included with the kit.

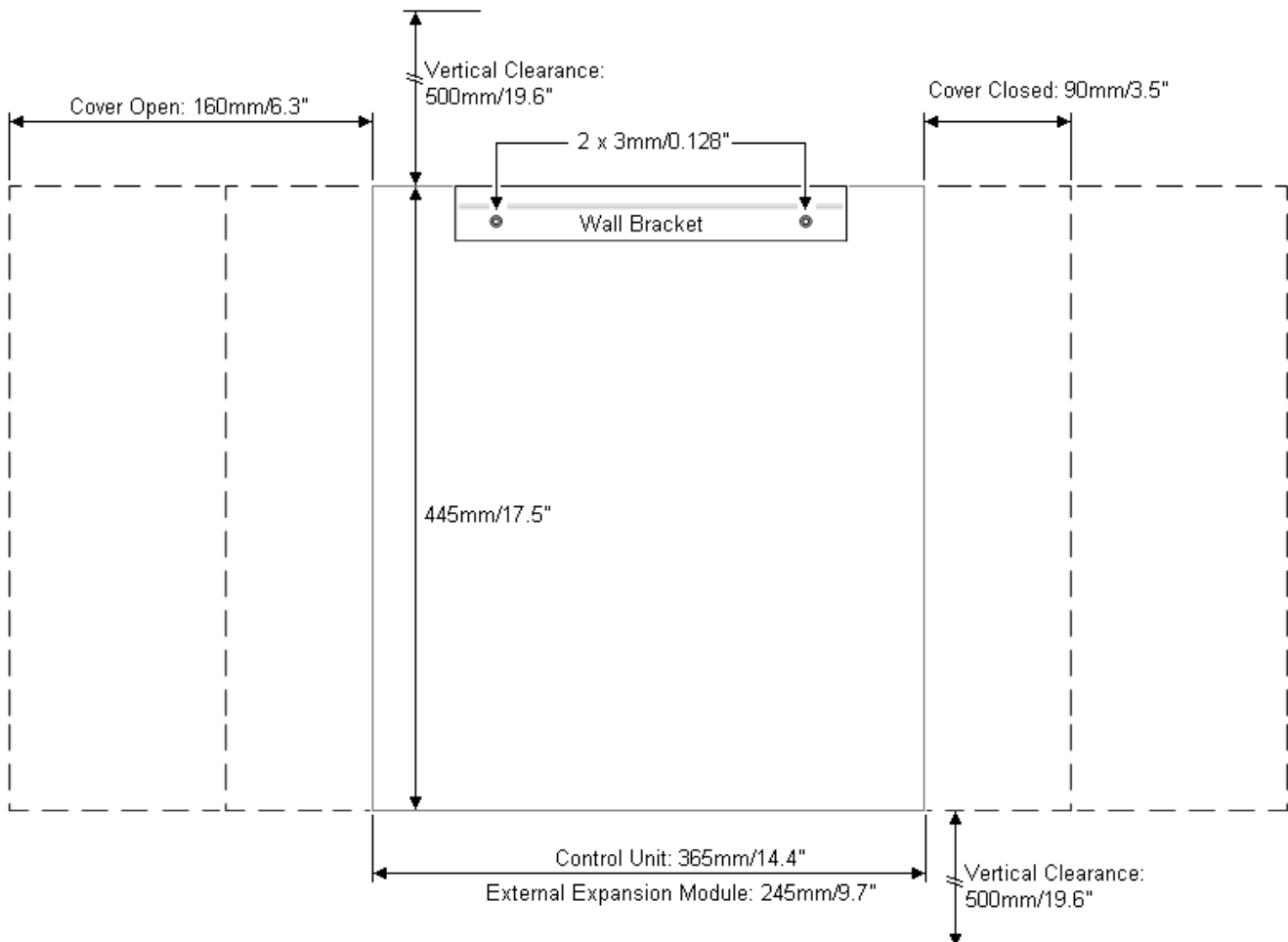

## 6.2 Rack Mounting

All IP Office control units and external expansion modules can be rack mounted into standard 19" rack systems. Each unit requires a 2U slot space within the rack. The IPO IP500 RACK MNTG KIT V3 is used for rack mounting of units.

Where IP Office systems are being rack mounted, the effect of conditions within the rack cabinet must be considered. For example the rack temperature may be above the room temperature and airflow within the rack will be restricted. The [environmental requirements](#)<sup>[53]</sup> for the individual IP Office units are still applicable inside the rack cabinet.

### Barrier Box Rack Mounting Kit

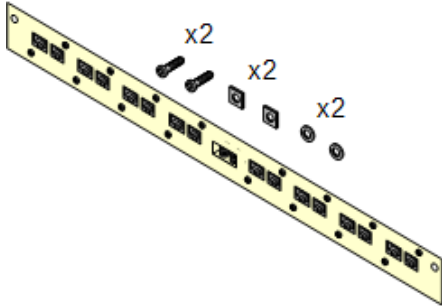

- **Barrier Box Rack Mounting Kit** (SAP 700293905)  
Barrier boxes must be used for [out-of-building analog phone extensions](#)<sup>[36]</sup>. This bracket allows up to 8 IP Office barrier boxes to be rack mounted and simplifies the number of connections to the protective ground point in the rack. This kit must be used when more than 3 barrier boxes are in use and supports a maximum of 16 barrier boxes for a single external expansion module.

### Environmental Requirements

In addition to the existing [environmental requirements](#)<sup>[53]</sup> for an IP Office system, the following additional factors must be considered when rack mounting a unit:

1. Rack Positioning - Ensure compliance with the rack manufacturers safety instructions. For example check that the rack legs have been lowered and fixing brackets have been used to stop toppling.
2. Elevated Operating Ambient - If installed in a closed or multi-unit rack assembly, the operating ambient temperature of the rack environment may be greater than room ambient. Therefore, consideration should be given to installing the equipment in an environment compatible with the maximum ambient temperature (T<sub>ma</sub>) specified by the manufacturer.
  - Operating Temperature: 5°C (40°F) to 40°C (104°F).
  - Operating Humidity: 10% to 95% non-condensing.
3. Reduced Air Flow - Installation of the equipment in a rack should be such that the amount of air flow required for safe operation of the equipment is not compromised. Proper ventilation must be maintained. The side ventilation slots on the IP500 control unit should not be covered or blocked.
4. Mechanical Loading - Mounting of the equipment in the rack should be such that a hazardous condition is not achieved due to uneven mechanical loading.
5. Circuit Overloading - Consideration should be given to the connection of the equipment to the supply circuit and the effect that overloading of the circuits might have on overcurrent protection and supply wiring. Appropriate consideration of equipment nameplate ratings should be used when addressing this concern.
6. Reliable Earthing - Reliable earthing of rack-mounted equipment should be maintained. Particular attention should be given to supply connections other than direct connections to the branch circuit (e.g. use of power strips).
7. ⚠ Only the screws provided with the mounting kit should be used to attach the brackets to the control unit.

## 6.3 Connecting External Expansion Modules

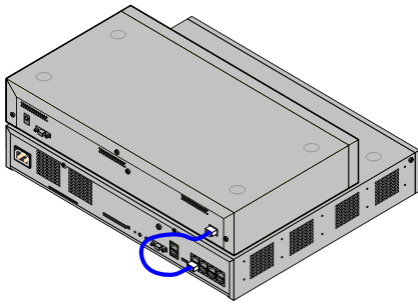

Any external expansion modules should be connected to the control unit before power is applied to the control unit. Ensure that modules are attached in the order that matches the planned or pre-built configuration.

External expansion modules connect to the IP Office control unit using an expansion interconnect cable. Each module is supplied with an expansion connect cable and a [power supply unit](#)<sup>[30]</sup>. An appropriate [locale specific power cord](#)<sup>[31]</sup> for the power supply unit must be ordered separately.

- Each external expansion module is supplied with a blue 1 meter (3'3") expansion interconnect cable. This cable must be used when connecting to expansion ports on the rear of a control unit.
- When connecting to expansion ports on an IP500 4-Port Expansion card, a yellow 2 meter (6'6") expansion interconnect cable can be used in place of the standard blue cable. 4 Yellow cables are supplied with the IP500 4-Port Expansion card.

### Installation Requirements

- Installation space either on or under the existing IP Office control unit. See [Rack Space Requirements](#)<sup>[58]</sup> for the positioning of multiple stacked modules.
- Switched power outlet socket.  
The power outlet used must include a switch and in cases where the [power cord](#)<sup>[31]</sup> includes an earth lead, that outlet must have a protective earth connection.
- Available EXPANSION port on the control unit.
- Grounding Requirements
  - **Functional Grounding**  
Connection of a [functional earth](#)<sup>[35]</sup> is:
    - Recommend for all modules.
    - Connection of a functional ground is mandatory for Analog Trunk modules.
  - **Protective Grounding**  
Connections of a protective ground via [surge protection equipment](#)<sup>[36]</sup> is:
    - Mandatory for Analog trunk modules in the Republic of South Africa.
    - Mandatory for Digital Station and Phone modules connected to out of building extensions.
    - Mandatory for Digital Station V2 and Phone V2 modules.

### Tools Required

- IP Office Manager PC.
- [Tools for rack mounting](#)<sup>[87]</sup> (optional).

### Parts and Equipment Required

- **External Expansion Module.**  
Each module is supplied with a suitable external power supply unit and a 1m blue interconnect cable. 2m Yellow interconnect cables are supplied with the IP500 4-Port Expansion card and should only be used with that card.
- [Power cord for the power supply unit](#)<sup>[31]</sup>.
- [Rack mounting kit](#)<sup>[37]</sup> (optional).
- Wall mounting kit - IP500 external expansion modules only (optional).
- Cable labeling tags.



## Procedure

1. External expansion modules should not be attached to a control unit that has power. If adding a new module to an existing system, [shutdown the system](#)<sup>[147]</sup>.
2. If the IP Office system is being installed in a rack, attach the [rack mounting kit](#)<sup>[87]</sup> to the expansion module.
3. Attach the external expansion module's power supply but do not switch power on.
4. Connect the expansion interconnect cable from the module's EXPANSION port to the EXPANSION port on the control unit. Make careful note of the port used and include this detail on the cable label and any other system records.

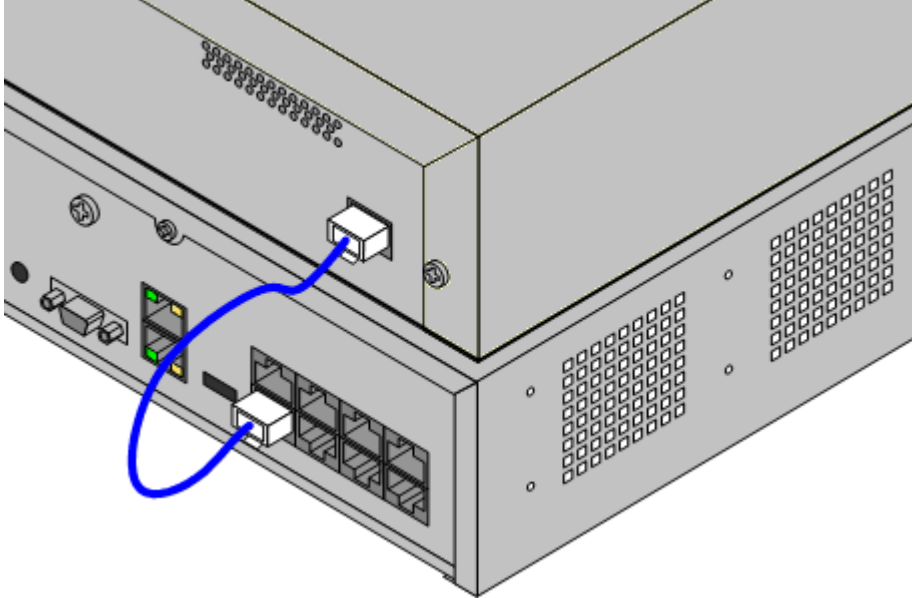

5. Attach any other external expansion modules being added.
6. You can now [attach the grounding cabling](#)<sup>[90]</sup> for the external expansion modules.
7. Once the expansion modules are connected and grounded you can [start the system](#)<sup>[92]</sup>. Ensure that the external expansion module's are started before the control unit.

## 6.4 Grounding

Use of ground connections reduces the likelihood of problems in most telephony and data systems. This is especially important in buildings where multiple items of equipment are interconnected using long cable runs, for example phone and data networks.

All IP Office control units and external expansion modules must be connected to a functional ground. Where the unit is connected to a power outlet using a power cord with an earth lead, the power outlet must be connected to a protective earth.

In some cases, such as ground start trunks, in addition to being a protective measure this is a functional requirement for the equipment to operate. In other cases it may be a locale regulatory requirement and or a necessary protective step, for example areas of high lightning risk.



- **⚠ WARNING**  
During installation do not assume that ground points are correctly connected to ground. Test ground points before relying on them to ground connected equipment.
- **Additional protective equipment**  
In addition to grounding, additional protective equipment will be required in the following situations.
  - On any Digital Station or Phones external expansion module connected to an extension located in another building. Refer to "[Out of Building Telephone Installations](#)".
  - In the Republic of South Africa, on all Analog Trunk external expansion modules (ATM16) and on any control units containing an analog trunk cards (ATM4/ATM4U).

### Tools Required

- □ M4 Cross-Head Screwdriver.
- □ Tools suitable for crimping a cable spade.

### Parts and Equipment Required

- □ 14AWG Solid copper wire for ground connection.
- □ Cable sleeve matching local regulator requirements. Typically green for a functional ground and green/yellow for a protective ground.

The ground point on IP Office control units and expansion modules are marked with a  or  symbol. Ground connections to these points should use a 14 AWG solid wire with either a green sleeve for a functional ground or green and yellow sleeve for a protective ground.

### IP500 V2 Control Unit

On IP500 V2 control units the ground point is located above the RS232 DTE port.

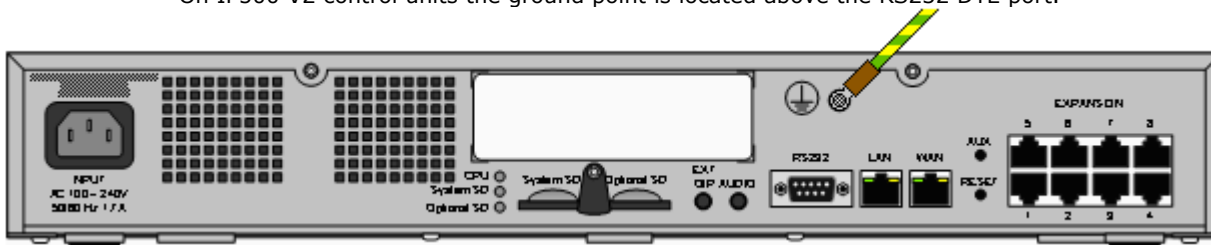

### External Expansion Modules

On expansion modules, the ground point is a 4mm screw located towards the right on the rear of the module.

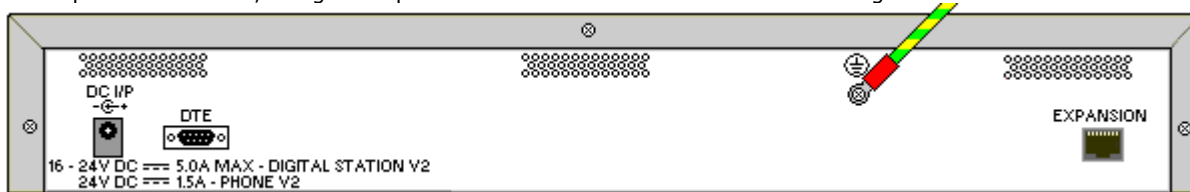

- On some older modules, the dedicated ground point screw is not present. In those cases, the top-center cover fixing screw (3mm) can be used as an alternative ground connection point. A toothed washer should be added to ensure good contact.

## 6.5 Network Connection

The section below details how a new IP Office system determines what IP address it should use.

### IP Address and DHCP Mode Resolution

When a defaulted or new IP Office control unit is switched on, it requests IP address information from a DHCP Server on the network. This operation will occur whether a LAN cable is connected or not. The process below is done separately for both the LAN port (LAN1 in the configuration) and the WAN port (LAN2 in the configuration) on the back of the IP Office control unit.

- The system makes a DHCP request for what IP address information it should use.
- If a DHCP server responds within approximately 10 seconds, the control unit defaults to being a DHCP client and uses the IP address information supplied by the DHCP server.
- If no DHCP Server responds, the control unit still defaults to being the DHCP client but assumes the following default addresses:
  - LAN Port (LAN1): 192.168.42.1/255.255.255.0.
  - WAN Port (LAN2): 192.168.43.1/255.255.255.0.
  - Note that the IP Office does not check that these addresses are valid and or available on the network.
- Systems running in IP Office standard modes can be configured as a DHCP server. They can also be configured to only provide DHCP for Avaya IP phones and or for remote access dial-in connections. DHCP Server options are not supported for systems running in IP Office Basic Edition modes.
- **!** Once an IP500 V2 control unit has obtained IP address and DHCP mode settings, it will retain those settings even if rebooted without a configuration file present on the System SD card. To fully remove the existing IP address and DHCP mode settings, the IP Office must be defaulted using IP Office Manager.

### PC Connection

Depending on the conditions that applied when the IP Office control unit was first started, a PC can be connected as follows:

- **If the IP Office is not connected to a network:**  
Connect the PC directly to the IP Office. It must be set to an address valid on the same network as the IP Office defaults above.
- **If the IP Office is connected to a network with no DHCP server:**  
Connect the PC directly to the IP Office. It must be set to an address valid on the same network as the IP Office defaults above.
- **If the IP Office is connected to a network with a DHCP server:**  
Connect the PC to the network. It must be set to be a DHCP client or to an address that is valid for the network.

## 6.6 Starting the System

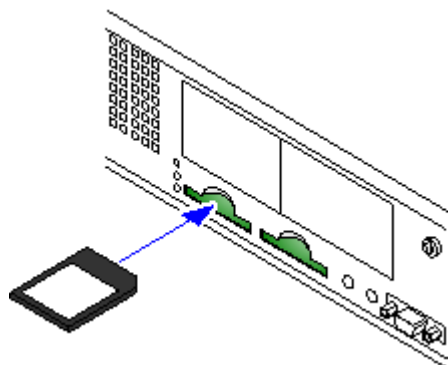

1. Before inserting the System SD card:
  - a. Ensure that you have the correct type of [Avaya System SD card](#) <sup>[196]</sup>.
  - b. Ensure that the card has the required level of software. If necessary, [upgrade the card using IP Office Manager](#) <sup>[75]</sup>.
2. With the control unit shut down or unpowered:
  - a. The SD card slots are covered by a plastic tab. Partially release the screw holding the tab so that it can be moved clear of the required card slot.
  - b. Insert the card into the **System SD** slot on the rear of the control unit.
3. Apply power to any external expansion modules.
4. Apply power to the control unit. The power outlet used must include a switch and the power outlet must have a protective earth connection.
5. The control unit loads firmware from the System SD card with which it upgrades itself and its internal components. This takes approximately a minute. The end of this process is indicated by LED1 on each base card flashing every 5 seconds. LED9 on each base card fitted with a trunk daughter card also flashes.
6. The control unit then begins upgrading the external expansion modules if necessary. This is indicated by the center LED on the module flashing red. This process is completed when the LED changes to steady green.
7. If a configuration file is already [present on the System SD](#) <sup>[77]</sup> card it is loaded by the IP Office. If not, new systems create a default configuration and copy that configuration onto the System SD card.
8. It should be possible now to use IP Office Manager to access the configuration of the IP Office.

### Control Unit Startup LEDs

#### Front

The LEDs on the rear of the control unit go through the following sequence during a normal start up. Note that the times are approximately only:

LED	4s	4s	12s	5s	2s	5s	5s	10s	10s	Finished
CPU	Orange	Green	Green	Green	Green	Green	Green	Green	Green	Green
System SD	Orange	Off	Green	Green	Green	Off	Green	Green	Green	Green
Optional SD If present.	Orange	Off	Green	Green	Green	Off	Off	Green	Green	Green

#### Rear

On the front of the control unit, LED1 on any IP500 base cards fitted is used as follows. LED9 is also used for any trunk daughter cards fitted.

LED	30s	30s	Finished
LED1/LED9	Red	Red	Red
		Fast Flash	Flash every 5 seconds

## 6.7 Checking the LEDs

### Control Unit LEDs

LED	Description
Optional SD	<ul style="list-style-type: none"> <li>• <b>Off</b> = Card shutdown.</li> <li>• <b>Green on</b> = Card present.</li> </ul>
System SD	<ul style="list-style-type: none"> <li>• <b>Green flashing</b> = Card in use.</li> <li>• <b>Orange steady</b> = Reset imminent.</li> <li>• <b>Red flashing</b> = Card initializing or shutting down.</li> <li>• <b>Red fast flashing</b> = card full</li> <li>• <b>Red steady</b> = Card failure/wrong type.</li> </ul>
CPU	<ul style="list-style-type: none"> <li>• <b>Alternate red/green</b> = Starting up.</li> <li>• <b>Green on</b> = Okay.</li> <li>• <b>Red on</b> = No software.</li> <li>• <b>Flashing Red</b> = Error/Shutdown.</li> </ul>

### Base Card LEDs

Base Card	LEDs 1 to 8 Usage												
All Cards	<ul style="list-style-type: none"> <li>• LED1 is also used for base card status: <ul style="list-style-type: none"> <li>• <b>Red On</b> = Error</li> <li>• <b>Red Slow Flash</b> = Initializing.</li> <li>• <b>Red Flash every 5 seconds</b> = Card okay.</li> <li>• <b>Red Fast Flash</b> = System shutdown.</li> </ul> </li> </ul>												
IP500 Analog Phone	<ul style="list-style-type: none"> <li>• No status LEDs are used for analog phone extensions.</li> </ul>												
IP500 Digital Station	<ul style="list-style-type: none"> <li>• <b>Green Flashing</b> = Phone detected.</li> <li>• <b>Green On</b> = Phone active.</li> </ul>												
IP500 TCM8	<ul style="list-style-type: none"> <li>• <b>Green On</b> = Phone detected.</li> </ul>												
IP500 Combination	<ul style="list-style-type: none"> <li>• LEDs 1 to 6 <ul style="list-style-type: none"> <li>• <b>Green Flashing</b> = Phone detected.</li> <li>• <b>Green On</b> = Phone active.</li> </ul> </li> </ul>												
IP500 VCM	<ul style="list-style-type: none"> <li>• LEDs 1 to 8 are unlabelled. They are used to indicate voice compression channel usage. Each LED lit represents 12.5% of the available voice compression channel capacity in use (total card capacity rather than licensed capacity).</li> </ul>												
IP500 4-Port Expansion	<ul style="list-style-type: none"> <li>• LEDs 1 to 8 are used for the expansion ports on the rear of the control unit. LEDs 9 to 12 are used for the card's own expansion ports. <table border="1" data-bbox="497 1176 1327 1321"> <tbody> <tr> <td><b>Green</b></td> <td><b>On</b></td> <td>Expansion module present.</td> </tr> <tr> <td><b>Red</b></td> <td><b>Flashing</b></td> <td>Initializing.</td> </tr> <tr> <td><b>Red</b></td> <td><b>On</b></td> <td>Error.</td> </tr> <tr> <td><b>Orange</b></td> <td><b>Regular Flash</b></td> <td>Base card okay.</td> </tr> </tbody> </table> </li> </ul>	<b>Green</b>	<b>On</b>	Expansion module present.	<b>Red</b>	<b>Flashing</b>	Initializing.	<b>Red</b>	<b>On</b>	Error.	<b>Orange</b>	<b>Regular Flash</b>	Base card okay.
<b>Green</b>	<b>On</b>	Expansion module present.											
<b>Red</b>	<b>Flashing</b>	Initializing.											
<b>Red</b>	<b>On</b>	Error.											
<b>Orange</b>	<b>Regular Flash</b>	Base card okay.											

### Trunk Daughter Card LEDs

Trunk Daughter Card	LEDs 9 to 12 Usage
All cards	<ul style="list-style-type: none"> <li>• LED 9 is also used for daughter card status. <ul style="list-style-type: none"> <li>• <b>Red On</b> = Error</li> <li>• <b>Red Slow Flash</b> = Initializing.</li> <li>• <b>Red Flash every 5 seconds</b> = Card okay.</li> <li>• <b>Red Fast Flash</b> = System shutdown.</li> </ul> </li> </ul>
Analog Trunk	<ul style="list-style-type: none"> <li>• <b>Green on</b> = V1: Card installed. V2: Line connected to the port but idle.</li> <li>• <b>Green flashing</b> = Line in use.</li> </ul>
PRI Trunk	<ul style="list-style-type: none"> <li>• <b>Off</b> = No trunk present.</li> <li>• <b>Green on</b> = Trunk present.</li> <li>• <b>Green flashing</b> = Trunk in use.</li> <li>• <b>Red/Green Fast Flash</b> (port 9) or <b>Green Fast Flash</b> (port 10) = Alarm indication signal (AIS) from the trunk remote end.</li> <li>• <b>Red with Green Blink</b> (port 9) or <b>Green Blink</b> (port 10) = Port in loopback mode (set through IP Office System Monitor).</li> </ul>
BRI Trunk	<ul style="list-style-type: none"> <li>• <b>Off</b> = No trunk present.</li> <li>• <b>Green on</b> = Trunk present.</li> <li>• <b>Green flashing</b> = Trunk in use.</li> </ul>

---

## External Expansion Module LEDs

Module	LEDs
All	<p>The center LED on all external expansion modules is used to indicate the overall state of the module as follows:</p> <ul style="list-style-type: none"><li>• <b>Red flashing</b> = Module starting up/Loading firmware.</li><li>• <b>Red on</b> = Error.</li><li>• <b>Green on</b> = Module okay.</li><li>• <b>Green flashing</b> = Module starting up/Loading firmware (IP500 DS16A/30A module only).</li></ul>
Analog Trunk 16	<ul style="list-style-type: none"><li>• None.</li></ul>
BRI So8	<ul style="list-style-type: none"><li>• <b>Green On</b> = Connected.</li><li>• <b>Green Flashing</b> = Activity.</li></ul>
Digital Station 16/30	<ul style="list-style-type: none"><li>• <b>Green Flashing</b> = Phone detected.</li><li>• <b>Green On</b> = Phone active.</li></ul>
Digital Station 16A/30A	<ul style="list-style-type: none"><li>• <b>Green On</b> = Phone detected.</li></ul>
Phone	<ul style="list-style-type: none"><li>• None.</li></ul>

## 6.8 Connecting Phones

During initial power up, the IP Office automatically creates extension and user entries for all analog and digital extension ports (DS and BST) in the system. This allows those devices to be connected without any additional programming.

- **! Warning**

If the system has been upgraded from a previous release of IP Office software, all phones will be restricted from making any calls until a [system upgrade license](#)<sup>[369]</sup> has been entered. The dialing restriction includes not being able to make emergency calls.

- This section does not cover the installation of DECT, H323 and SIP telephones. For installation of those devices refer to the appropriate supplementary installation manuals.

### 6.8.1 Analog Phones

Connect any analog phones to their appropriate [Phone](#)<sup>[365]</sup> ports. Ensure that those connected to [power failure ports](#)<sup>[49]</sup> are clearly labeled as such.

### 6.8.2 ETR Phones

Connect any ETR phones to their appropriate [ETR](#)<sup>[367]</sup> ports. These phones do not need to load additional firmware.

### 6.8.3 DS Digital Station Phones

Connect any digital phones to their appropriate [DS](#)<sup>[366]</sup> ports. These phones may need to upgrade their firmware to match that supported by the IP Office core software. The appropriate firmware is supplied with the IP Office Manager software and copied onto the System SD card for IP500 V2 systems.

The phones will automatically load the firmware from the IP Office system if necessary.

- The upgrade process takes approximately 10 minutes during which time the phone will display a warning. The phone should not be disconnected during this process.
- Once the phone connected to a port has been upgraded, the IP Office will not check whether the phone on that port needs to be upgraded again except following a system reboot, i.e. multiple phones cannot be upgraded by swapping the connected phones on the same port.

### 6.8.4 TCM/BST Phones

Connect any BST phones to their appropriate BST ports. These phones do not need to load additional firmware.

#### DS30B Module

The IP500 DS16B and DS30B external expansion modules support either BST or DS ports. The port type for a whole module is configured using IP Office Manager. See [DS16B/30B Port Mode Selection](#)<sup>[112]</sup>.

#### Default Buttons

For system's with BST phone ports, when a phone is first connected to the port, the button programming of the associated user is overwritten with the default button programming appropriate for the phone model.

If the new system is being installed with a pre-staged configuration that include user button programming, the automatic defaulting of buttons to match the phone type will overwrite the user button settings. This behavior can be prevented by adding the following short code to the user's setup in the pre-programmed configuration:

- **Code:** \*DCP
- **Feature:** Dial
- **Telephone Number:** 84000004,1,1,0

The 4000004 part of the string above can also be used to adjust the defaults for the following phone settings:

- The first digit sets the phone contrast = 1 (low) to 9 (high).
- The last digit sets the ringer volume = 0 (high) to 7 (low).

Note that subsequently removing this short code will cause the buttons to return to defaulting according to the phone type.

#### Phone Type Setting

For some phones, the phone can only report its general type to the system rather than its specific model. It is recommended that after connecting all the phones, the phone types should be correctly set in the IP Office configuration.

---

- **! Important**

The default types cannot be changed after installation without defaulting the configuration. Therefore you must ensure that you connect the correct type of phone to each port. If you need to swap phones, use the process for [exchanging extension numbers](#)<sup>[17]</sup> rather than swapping wiring.

1. Using IP Office Manager, receive the configuration from the system.
2. Select **Extension**.
3. Selecting each extension in turn, on the **Extn** tab, check that the **Device Type** field is set to the correct phone model.

Default Type	Possible Phone Models
<b>T7100</b>	T7100, M7100, M7100N, Audio Conferencing Unit.
<b>T7208</b>	T7208, M7208, M7208N.
<b>M7310</b>	T7406E, T7406, M7310, M7310N
<b>M7310BLF</b>	T7316, M7310BLF
<b>M7324</b>	M7324, M7324N

4. Save the configuration back to the IP Office system.

## 6.8.5 IP/SIP Phones

The installation and configuration of H323 and SIP IP telephones is not covered by this document. Refer to the appropriate IP Office installation manual for the type of phone being installed.



# Chapter 7.

# Configuration Using IP Office Manager

---

## 7. Configuration Using IP Office Manager

This section covers basic configuration changes required for IP Office systems if using the IP Office Manager application. This covers just the basic configuration, the full range of configuration possible through IP Office Manager is covered in the IP Office Manager manual.

1. [Initial Configuration](#) <sup>[99]</sup>  
The **Initial Configuration** menu is shown the first time that IP Office Manager connects to a new system.
2. [Enter Licenses](#) <sup>[101]</sup>  
Enter licenses for features that require them.
3. [Set the System Locale](#) <sup>[102]</sup>  
Setting the correct system locale affects a wide range of settings including trunk settings. The correct locale must be set for a system to operate correctly.
4. [Set the Extension Numbering](#) <sup>[104]</sup>  
Renummer the user extensions if required.
5. [Change the IP Address/DHCP Settings](#) <sup>[103]</sup>  
If necessary, the IP address and DHCP mode of the IP Office system can be changed.
6. [Remove any Unused Trunks](#) <sup>[106]</sup>  
Disabling the use of trunks and trunk channels that are not available.
7. [Select the Clock Source for Digital Lines](#) <sup>[108]</sup>  
Altering which digital trunk is used to provide the IP Office with its clock signal for call synchronization.
8. [Enter Trunk Prefixes](#) <sup>[110]</sup>  
On systems where a prefix is being used for external dialing, ensure that the same prefix is added to incoming numbers in order to allow return calls.
9. [DS16B/30B Port Mode Selection](#) <sup>[112]</sup>  
These modules can support Avaya T-Series and M-Series phones by providing BST ports or other Avaya digital phones by providing DS ports. The port type selection for the whole module is done using IP Office Manager.

## 7.1 Initial Configuration

Unless the System SD card contained a pre-built configuration, IP Office Basic Edition is the default mode assumed by a new or defaulted control unit.

### To start the initial configuration:

1. Using IP Office Manager, [connect to the system](#) and receive its configuration. The default name and password are both **Administrator**.
2. When IP Office Manager is first connected to the new system, you are prompted to change the default passwords.

3. Enter the new password or passwords and click **OK**. Once the password changes are confirmed, the **Initial Configuration** menu is displayed, prompting you to confirm the required operating mode for the system.

4. Select **IP Office Standard Mode** and click **Save**.

5. The menu prompts you for additional settings:

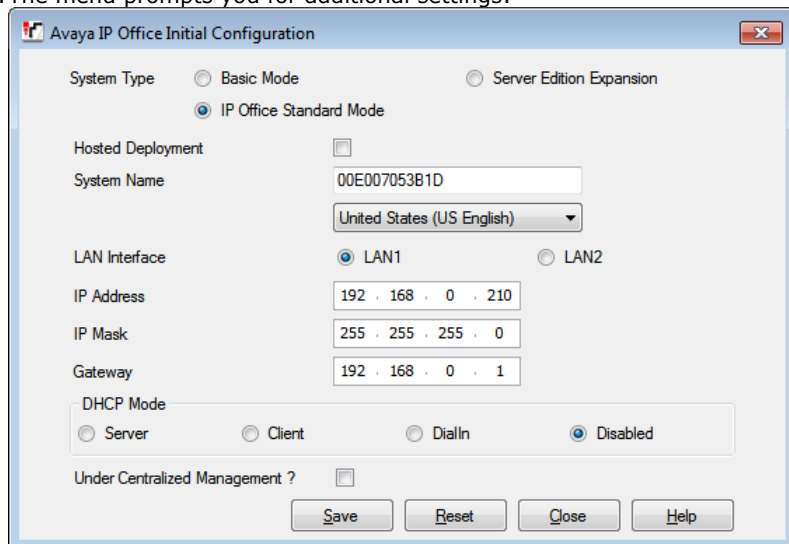

6. Check that the settings match those required for the customer site.

7. Click **Save**. The new configuration is opened in IP Office Manager.

8. Click on the  save icon and save the updated configuration back to the IP Office system. Once the system has rebooted, you can continue with the initial configuration [using IP Office Manager](#)<sup>[98]</sup>.



## 7.2 Entering Licenses

For IP500 V2 control units, [license files can be pre-loaded](#) onto the System SD card. Those licenses will then be merged with the configuration when the control unit is powered up. Otherwise for all control units, licenses are entered into the configuration using IP Office Manager. In addition to the methods below, license can also be added by placing the additional licenses as a [text file on the System SD card](#).

You must ensure that the licenses being entered have been issued against the **FK** serial number of the System SD card fitted in the system. Each license is a unique 32-character string based on the feature being licensed and the serial number of the SD card plugged into the system control unit.

Entering licenses manually is liable to errors caused by miskeying the correct 32-character string.

### To enter licenses:

1. [Start IP Office Manager](#) and receive the configuration from the IP Office system.
2. Select  **System**.
3. The field **Dongle Serial Number** shows the serial number of the System SD card fitted to the system. Check that this number matches the one against which the licenses have been issued.
4. Select  **License**.
5. To add a license, click **Add...**
6. For the license type select **ADI** and click **OK**.
7. Enter the new license key and click **OK**. We recommend that add licenses by cut and pasting them from a supplied file listing each 32-character license keys. That avoids potential issues with mistyping.
8. The **Status** of the new license should show **Unknown** and name the license as expected. If the name is **Invalid**, the most likely cause is incorrect entry of the license key characters.
9. Click on the  save icon to send the configuration back to the IP Office.
10. Use IP Office Manager to receive the configuration again and check that the status of the license. It should now be **Valid**.

---

## 7.3 Setting the System Locale



Setting the correct [system locale](#)<sup>43)</sup> affects a wide range of settings including trunk settings. The correct locale must be set for a system to operate correctly. It will also set the default language used for phone displays and for voicemail prompts. However language settings can be changed separately from the system locale if different language operation is required.

- **! WARNING**

This process requires the IP Office system to reboot in order to complete the changes. The reboot ends all current calls and services.

- This process can be performed through phone based administration from either of the first two systems in the system. For details, refer to the Phone Based Administration manual.

### To set the system locale:

1. [Start IP Office Manager](#)<sup>69)</sup> and receive the configuration from the IP Office system.
2. Click on  **System**.
3. Click on the **System** tab.
4. Use the **Locale** drop down list to select the required locale. The default language for the locale is shown in brackets, for some locales there may be more than one entry with different default languages for each.
  - The supported countries are **Argentina, Australia, Bahrain, Belgium, Brazil, Canada, Chile, China, Czech, Denmark, Egypt, Finland, France, Germany, Greece, Hong Kong, Hungary, Iceland, India, Italy, Japan, Korea, Kuwait, Mexico, Morocco, Netherlands, New Zealand, Norway, Oman, Pakistan, Peru, Philippines, Poland, Portugal, Qatar, Russia, Saudi Arabia, Singapore, South Africa, Spain, Sweden, Switzerland, Taiwan, Turkey, United Arab Emirates, United States, Venezuela**.
  - If the option **Customize** is selected, the following additional fields are available:
    - **Tone Plan:** *Default = Tone Plan 1*  
Select a tone plan to be used for different ringing signals such as dial tone and ring tone.
    - **CLI Type:** *Default = FSK V23*  
Set the method for passing caller ID information to analog extensions. The options are **DTMF, FSK Bell 202** or **FSK V23**.
  - IP500 V2 Systems: If the system is configured to use Embedded Voicemail (the default for a new system), and the correct set of language prompts to match the locale are not present on the System SD card, IP Office Manager displays an error. The **Add/Display VM locales** option (*File | Advanced | Add/Display VM locales*) can be used to upload the language prompts from IP Office Manager.
5. Click on the  save icon and save the updated configuration back to the IP Office system.

## 7.4 Changing the IP Address Settings

When a new or defaulted IP Office is switched on, the control unit will make a DHCP requests for IP address settings on each of its LAN interfaces. That is on its LAN port (LAN1) and on its WAN port (LAN2).

- If the IP Office receives a response from a DHCP server, it will configure itself as a DHCP client using the address details provided by the DHCP server.
- If the IP Office does not receive a response from a DHCP server, it will still configure itself as a DHCP server but using the following default address details:



Network Settings	LAN Port (LAN1)	WAN Port (LAN2)
IP address	192.168.42.1.	192.168.43.1
IP Mask	255.255.255.0	255.255.255.0
DHCP Mode	Client	Client
No of DHCP IP Addresses	200.	200.

If the IP address and DHCP mode settings are not suitable for the customers network they should be changed. Note that changing the IP Office's IP address settings requires it to restart.

- **! WARNING**

This process requires the IP Office system to reboot in order to complete the changes. The reboot ends all current calls and services.

### To change the IP address settings:

1. [Start IP Office Manager](#)  and receive the configuration from the IP Office system.
2. Click on  **System**.
3. On the **System** tab, in the **Name** field enter a distinctive name for the IP Office system. Click **OK**.
4. Click on the **LAN1** tab.
5. On the LAN Settings sub-tab, change the IP Address, IP Mask and DHCP Mode settings to match the customer requirements. These settings are used for the **LAN** port on the back of the IP Office control unit. Click **OK**.
6. Repeat the process for the **LAN2** tab. Those settings are used for the **WAN** port on the back of the IP Office control unit.
7. Click on the  save icon and save the updated configuration back to the IP Office system.

## 7.5 Extension Numbering

IP Office standard mode systems can use a mix of extension numbers up to 9 digits in length. By default, hunt groups and extensions are given 3-digit extension numbers starting from 200 upwards.

### To change extension numbers

IP Office Manager can be used to renumber all extensions on the system. This will also update any references to the extension number in other configuration fields.

1. [Start IP Office Manager](#) and receive the configuration from the IP Office system.
2. Select **Tools | Extension Renumber**.

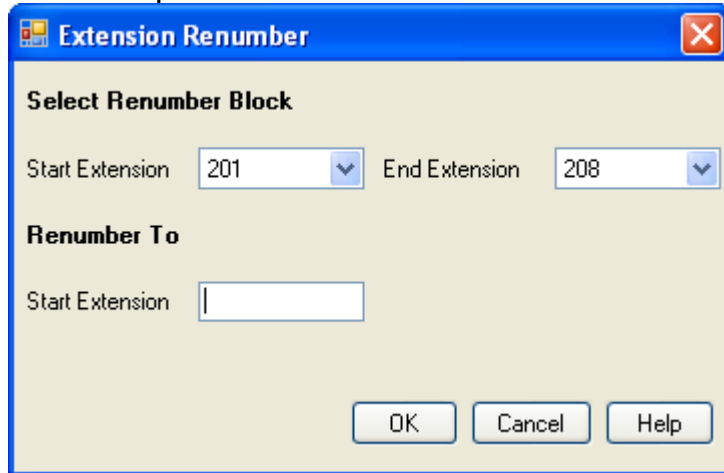

3. Click on the  save icon and save the updated configuration back to the IP Office system.

### To changing an individual user's extension number:

1. Select  **User**. Locate and select the relevant user.
  - a. On the **User** tab, change the Extension number to the required new number.

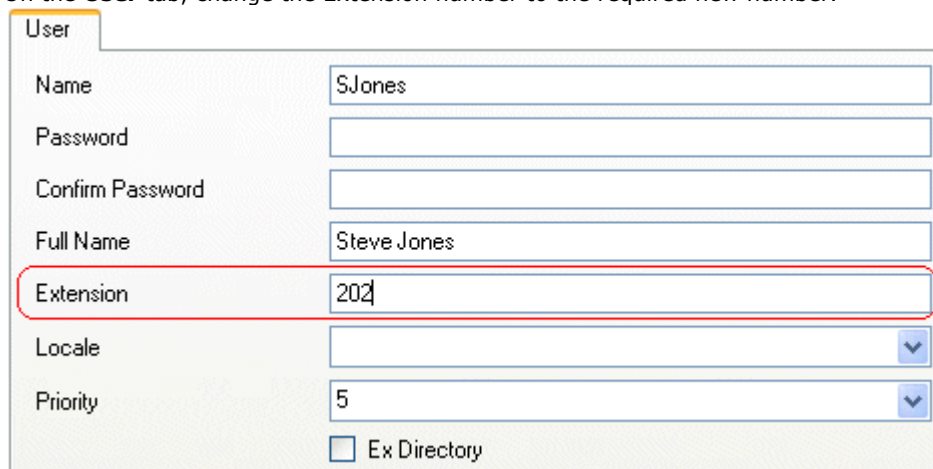

- b. Click on another field. If an error warning appears it will most likely be due to a conflict with an existing use of that extension number.

- If this an error, click **Cancel** to return the user to their original extension number.
- If this is intended as the other entry will be corrected click **OK** and then edit the other entry.
- When **OK** is clicked, IP Office Manager will automatically propagate the number change to any hunt groups, incoming call routes, user buttons, bridged appearance buttons and call coverage appearance buttons associated with the user's original extension number.

2. If the user has an extension with which they are associated by being the extension's **Base Extension** setting, that setting is not automatically updated. If the user should still be associated with that extension by default, the extension must be updated manually to match the user's new extension number.

- a. Select  **Extension**.



- b. Change the **Base Extension number** to match the user extension who should now be associated with that extension port by default.

Extn	
Extension Id	35
Base Extension	203
Caller Display Type	On
Reset Volume After Calls	<input type="checkbox"/>
Device type	 Avaya 5410
Module	BD
Port	1

- c. Click **OK**. IP Office Manager will probably give a validation error message due to a user being associated with two extensions. This can be ignored until all the user moves have been completed.

3. If changing several users repeat the processes as required.
4. Click  to revalidate the configuration and check that no conflicts between users and associated extensions.
5. If the configuration changes are complete, send the configuration back to the IP Office and select appropriate settings for the reboot.

## 7.6 Disable Unused Trunks

Each IP Office trunk card provides a fixed number of trunk ports with digital trunk ports supporting a fixed number of digital channels. By default the IP Office configuration has configuration entries for all the possible trunks and channels.

In cases where the number of trunks or trunk channels in use or licensed is lower than the number supported by the trunk card, the unused trunks and channels must be disabled.

-  Failure to do this will cause problems with outgoing calls. For example, on a system with an ATM4 trunk card fitted but only two analog trunks actually connected, failure to disable the other two trunks within the IP Office configuration will cause 50% of outgoing call attempts to fail. This is because the system cannot automatically detect the service status of individual analog trunks.
  - For IP Office Release 8.1 Feature Pack 1 and higher with IP500 Analog Trunk 4 V2 cards and ATM4 Combination V2 cards, the system can detect with analog trunks are connected and so can automatically treat unconnected trunk ports as out of service.
- **! WARNING**  
This process requires the IP Office system to reboot in order to complete the changes. The reboot ends all current calls and services.

### To disable unused trunks:

1. [Start IP Office Manager](#) <sup>69</sup> and receive the configuration from the IP Office system.
2. Within the IP Office configuration, select  Line.
3. For each line, set those lines or channels that are not connected or being used as out of service. The location of the relevant setting varies for each trunk type.
  - **Analog Trunks**  
To disable the whole trunk, on the main form set the **Admin** option to **Out of Service**.
  - **BRI, E1 PRI, S0 and QSIG Trunks**  
To disable the whole trunk, on the main form set the **Admin** option to **Out of Service**. Otherwise set the number of channels to match the actual subscribed channels.

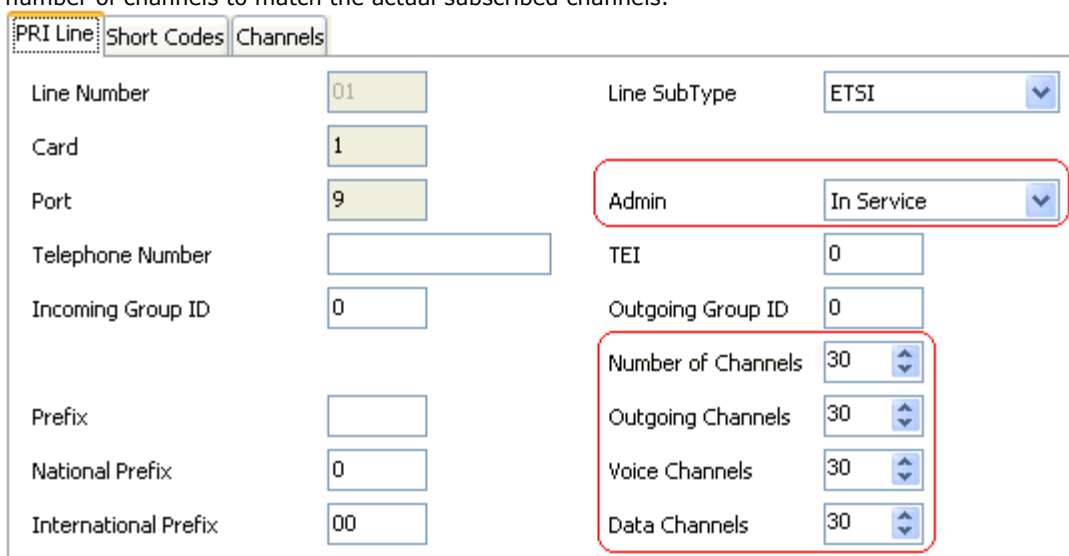

PRI Line		Short Codes	Channels
Line Number	01		Line SubType: ETSI
Card	1		Admin: In Service
Port	9		TEI: 0
Telephone Number			Outgoing Group ID: 0
Incoming Group ID	0		Number of Channels: 30
Prefix			Outgoing Channels: 30
National Prefix	0		Voice Channels: 30
International Prefix	00		Data Channels: 30

• **T1, T1 PRI and E1R2 Trunks**

To disable the whole trunk, on the main form set the **Admin** option to **Out of Service**. Otherwise select the Channels tab and set those channels that are not used to **Out of Service**.

PRI 24 Line Channels

Channel	Groups	Line Appearance	Direction	Bearer	Type
1	0 0	705	Bothway	Any	Ground Start
2	0 0	706	Bothway	Any	Ground Start
3	0 0	707	Bothway	Any	Ground Start
4	0 0	708	Bothway	Any	Ground Start
5	0 0	709	Bothway	Any	Ground Start
6	0 0	710	Bothway	Any	Ground Start
7	0 0	711	Bothway	Any	Ground Start
8	0 0	712	Bothway	Any	Ground Start
9	0 0	713	Bothway	Any	Out Of Service
10	0 0	714	Bothway	Any	Out Of Service
11	0 0	715	Bothway	Any	Out Of Service
12	0 0	716	Bothway	Any	Out Of Service
13	0 0	717	Bothway	Any	Out Of Service
14	0 0	718	Bothway	Any	Out Of Service
15	0 0	719	Bothway	Any	Out Of Service
16	0 0	720	Bothway	Any	Out Of Service
17	0 0	721	Bothway	Any	Out Of Service
18	0 0	722	Bothway	Any	Out Of Service
19	0 0	723	Bothway	Any	Out Of Service
20	0 0	724	Bothway	Any	Out Of Service
21	0 0	725	Bothway	Any	Out Of Service
22	0 0	726	Bothway	Any	Out Of Service
23	0 0	727	Bothway	Any	Out Of Service
24	0 0	728	Bothway	Any	Out Of Service

Edit...

- For T1 set the **Type** to **Out of Service**.
- For T1 PRI set the **Admin** field to **Out of Service**.
- For E1R2 trunks set the **Line Signalling Type** to **Out of Service**.

---

## 7.7 Setting the Digital Trunk Clock Source

Digital trunks require the telephone system at each end of the trunk to share a clock signal to ensure synchronization of call signalling. The IP Office can obtain and use the clock signal from any of its digital trunks. Typically the clock signal provided by a digital trunk from the central office exchange is used as this will be the most accurate and reliable clock source.

To do this, the **Clock Quality** setting on each line in the IP Office configuration is set to one of the following:

- **Network**  
If available, the clock signal from this trunk should be used as the IP Office's clock source for call synchronization. If several trunk sources are set as **Network**, the IP Office will default to using one as detailed below.
- **Fallback**  
If available, the clock signal from this trunk can be used as the clock source if none of the trunks set as **Network** are providing a clock source.
- **Unsuitable**  
The clock source from this trunk will never be used as the IP Office's clock source.

If no clock source is available the IP Office can use its own internal clock if necessary.

In the example below the first IP Office is set to use the public network trunk as its clock source and ignoring the possible clock source from the QSIG trunk. The other IP Office system is using the clock signal received from the first IP Office on its QSIG trunk as its clock source. Thus both IP Offices are using the same clock source and that clock source is the public network exchange.

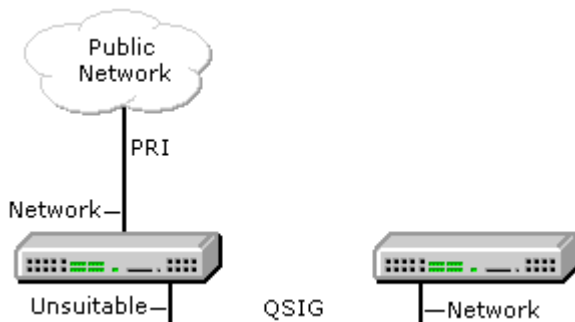

### Multiple Source Priority

When multiple trunks with the same setting are providing clock signals, the trunk used is determined in the order of slots 1 to 4 and then by port on each slot.

### Viewing the Current Clock Source

The current clock source being used by an IP Office system is shown on the Resources page within the System Status Application.

**To set a trunk's clock quality source:**

1. Within the IP Office configuration, select **Trunk** Line.
2. For each digital line, select the line and on the Line tab select whether that trunk should provide the clock source for the network or whether the trunk is unsuitable. For E1R2 trunks the **Clock Quality** setting is on the **Advanced** tab.

The screenshot shows the configuration page for a PRI 24 Line. The 'Channels' tab is active. The 'Clock Quality' dropdown menu is open, with 'Network' selected. Other settings include: Line Number: 01, Line SubType: T1, Channel Allocation: 24 -> 1, Prefix: (empty), Framing: ESF, CRC Checking: (unchecked), Zero Suppression: B&ZS, CSU Operation: (unchecked), Line Signalling: CPE, Haul Length: 0-115 ft, Incoming Routing Digits: 4, and Channel Unit: Foreign Exchange.

3. Ensure that only one trunk is set to **Network**. This should preferably be a direct digital trunk to the central office exchange.
4. One other trunk can be set a **Fallback** should the selected Network trunk connection be lost. If possible this should be a trunk from a different provider since that reduces the chances of both sources failing at the same time.
5. Ensure that all other digital trunks are set as **Unsuitable**.

## 7.8 Setting the Trunk Prefixes

By default, systems with a U-Law System SD card default to using a 9 prefix for external calls. Systems started with a A-Law System SD card default to no prefix (any dialing that doesn't match an internal number is assumed to be an external number).

Where a prefix is used for outgoing calls, that same prefix needs to be added to trunk settings. The trunk prefix is then used as follows:

- On incoming calls the prefix is added to any incoming ICLID received with the call. That allows the ICLID to be used by IP Office phones and applications to make return calls.
- On outgoing calls, the short codes used to route the call to a trunk must remove the dialing prefix.

### To set trunk prefixes:

1. Within the IP Office configuration, select **Line**.
2. For each line enter the prefix. The location of the relevant setting varies for each trunk type.

#### • Analog Trunks

The screenshot shows the 'Line Settings' tab for an 'Analogue Options' line. The 'Prefix' field is highlighted with a red circle and contains the value '9'. Other fields include Line Number (401), Telephone Number (empty), Incoming Group ID (0), Outgoing Group ID (0), Outgoing channels (1), Voice channels (1), National Prefix (0), and Line Appearance ID (739).

#### • T1 and T1 PRI Trunks

The screenshot shows the 'PRI 24 Line Channels' configuration interface. The 'Prefix' field is highlighted with a red circle and contains the value '9'. Other fields include Line Number (01), Line SubType (T1), Channel Allocation (24 -> 1), Clock Quality (Network), Framing (ESF), CRC Checking (checked), Zero Suppression (B&ZS), CSU Operation (unchecked), Line Signalling (CPE), Haul Length (0-115 ft), Incoming Routing Digits (4), and Channel Unit (Foreign Exchange).

• **BRI, E1 PRI, S0 and QSIG Trunks**

**SIP Trunk Prefixes**

For IP Office Release 6.0, the prefix fields **Prefix**, **National Prefix**, **Country Code** and **International Prefix** are available with the SIP Line settings. These fields are used in the following order:

1. If an incoming number (called or calling) starts with the + symbol, the + is replaced with the **International Prefix**.
2. If the **Country Code** has been set and an incoming number begins with that **Country Code** or with the **International Prefix** and **Country Code**, they are replaced with the **National Prefix**.
3. If the **Country Code** has been set and the incoming number does not start with the **National Prefix** or **International Prefix**, the **International Prefix** is added.
4. If the incoming number does not begin with either the **National Prefix** or **International Prefix**, then the **Prefix** is added.

For example, if the SIP Line is configured with prefixes as follows:

- **Line Prefix:** 9
- **National Prefix:** 90
- **International Prefix:** 900
- **Country Code:** 44

Number Received	Processing	Resulting Number
+441707362200	Following rule 1 above, the + is replaced with the <b>International Prefix</b> (900), resulting in 900441707362200.  The number now matches the <b>International Prefix</b> (900) and <b>Country Code</b> (44). Following rule 2 above they are replaced with the <b>National Prefix</b> (90).	901707362200
00441707362200	Following rule 2 above the <b>International Prefix</b> (900) and the <b>Country Code</b> (44) are replaced with the <b>National Prefix</b> (90).	901707362200
441707362200	Following rule 2 above, the <b>Country Code</b> (44) is replaced with the <b>National Prefix</b> (90).	901707362200
6494770557	Following rule 3 above the <b>International Prefix</b> (900) is added.	9006494770557

---

## 7.9 DS16B/30B Port Mode Selection



Each IP500 DS16B and IP500 DS30B external expansion module in a system can support either DS phone ports or BST phone ports. The modules default to DS phone port operation. The operating mode is set through the system configuration.

- **! WARNING**

This process requires the IP Office system to reboot in order to complete the changes. The reboot ends all current calls and services.

- The process of loading the appropriate firmware for the selected mode takes up to 10 minutes during which time the module is not available.

### To change the IP500 DS16B/30B module port mode:

1. Within the IP Office configuration, select  **Control Unit**. The control unit and external expansion modules are listed.
2. The IP500 DS16B and IP500 DS30B modules are listed as **DIG ADPx16 RJ45** and **DIG ADPx30 RJ45**.
3. Select one of the external expansion modules. In the unit details, the **Operating Mode** drop-down list is used to select what type of phones the module supports. Select the required mode.
  - For DS ports, select **DS - 1400, 9500, 5400, 2400, T3, 440 Series Phones**.
  - For BST ports, select **BST - T7000, M7000 Series Phones**.
4. Click **OK**.
5. Click on the  save icon and save the updated configuration back to the IP Office system.



# Chapter 8.

## Securing the System

---

## 8. Securing the System

The IP Office system and its applications support a range of features for making links between them and users more secure. Full details of the options available are described in the **Avaya IP Office Platform Security Guidelines** manual .

This section covers only the basic changes recommended to help make a new system more secure.

1. [Changing the default security settings](#)<sup>[115]</sup>
2. [Change the Remote User password](#)<sup>[116]</sup>
3. [Disabling SIP trunk support](#)<sup>[116]</sup>
4. [Disabling H.323 telephone support](#)<sup>[116]</sup>

### Additional recommendations:

- If the network to which the IP Office is attached has external public Internet access, that access must be controlled by some additional security devices such as a Firewall and, for VoIP, a Session Border Controller (SBC).
- If LAN2 (the WAN port) is not being used, ensure that it is not connected to the network.



## 8.1 Changing the Default Security Settings

This process covers the minimal security changes required for the IP Office service run by the server. For full details of all the IP Office security settings, refer to the IP Office Manager help.

### To set the initial security configuration:

1. Start IP Office Manager.
2. Select **File | Advanced | Security Settings**.
  - If the **Select IP Office Menu** does not appear, click .
3. Select the server and click **OK**.
4. Enter the administrator user name and password.
5. For a system with default security settings a number of warnings are displayed. Note each warning and click **OK**.
6. Select and change the following passwords:
  - a. **System Password**  
This password is used by IP Office Manager for system software upgrades. Click on the **Change** button and enter a new password. Click **OK**.
  - b. **Voicemail Password**  
This password is used by the Voicemail Pro server to connect to the IP Office system. When set, the same password also needs to be set in the voicemail server's preferences using the Voicemail Pro client.
  - c. **Monitor Password**  
This password is used by the System Monitor application to connect to the IP Office system using UDP or TCP. If not set, the **System Password** set above is used instead.
7. The **Application Controls** section indicates a number of unsecure interfaces used by the system. Deselect those that are not required by the planned customer applications. As you select or deselect the controls, the **Application Support** section below changes to show the effect of the change.

Application Control	Used by	Notes
<b>TFTP Server</b>	System Monitor	If disabled, in addition to disabling the other TFTP options below, the system cannot support the network viewer component in the System Monitor application.
<b>TFTP Directory Read</b>	IP DECT	If disabled, DECT operates without the system directory feature.
<b>TFTP Voicemail</b>	Voicemail Pro	Enable only when the system is using a pre-IP Office Release 9.1 voicemail server.
<b>Program Code</b>	IP Office Manager	Used for upgrades from IP Office Manager, recommend disabling when not required.
<b>DevLink</b>	DevLink	
<b>TAPI</b>	TAPI/DevLink	Disable unless the customer site will use TAPI applications with the IP Office.
<b>HTTP Directory Read</b>	one-X Portal for IP Office	Enable only when one-X Portal for IP Office is used. If disabled, one-X Portal for IP Office operates without the personal directory feature.
<b>HTTP Directory Write</b>	one-X Portal for IP Office	Enable only when one-X Portal for IP Office is used. If disabled, one-X Portal for IP Office operates without the personal directory update feature.



8. Click **OK**.
9. Click  **Service Users**. By default only the **Administrator** and **EnhTcpsaServer** users are enabled.
  - a. Select **EnhTcpsaService**. This service is used by one-X Portal for IP Office. If one-X Portal for IP Office is being installed, we recommend that the password is only changed after that installation is completed. If one-X Portal for IP Office is not being installed:
    - Click on the **Change** button and enter a new password for the service.
    - Click on **Account Status** and selected **Disabled**.
    - Click **OK**.
10. Click on the  icon to save the security changes.

---

## 8.2 Changing the Remote User Password

The IP Office configuration contains a user whose password is used as the default for remote dial in access to the IP Office network. The password of this user should be changed.

### To change the remote user password:

1. [Start IP Office Manager](#)  and connect to the IP Office system.
2. Click on  **Users** and in the list of users click on **Remote Manager**.
3. On the **User** tab, enter a new password for the user and click **OK**.
4. Click on the  icon and save the updated configuration back to the IP Office system.



## 8.3 Disabling SIP Trunk Support

The IP Office system supports SIP trunks. If these are not required for the customer installation, we recommend that the system's SIP trunk support is disabled.

### To disable SIP trunk support:

- **! WARNING**

This process requires the IP Office system to reboot in order to complete the changes. The reboot ends all current calls and services.

1. [Start IP Office Manager](#)  and receive the configuration from the IP Office system.
2. Select **System**.
3. Select **LAN1** and select the **VoIP** tab.
4. Check that **SIP Trunks Enable** is not selected.
5. Repeat the process for **LAN2**.
6. Click on the  save icon and save the updated configuration back to the IP Office system.



## 8.4 Disabling H.323 Telephone Support

The IP Office system support H.323 IP telephones by default. If these are not required for the customer installation, we recommend that the system's H.323 telephone support is disabled.

### To disable H.323.telephone support:

- **! WARNING**

This process requires the IP Office system to reboot in order to complete the changes. The reboot ends all current calls and services.

1. [Start IP Office Manager](#)  and receive the configuration from the IP Office system.
2. Select **System**.
3. Select **LAN1** and select the **VoIP** tab.
4. Check that **H323 Gatekeeper Enable** is not selected.
5. Check that **H323 Remote Extn Enable** is not selected.
6. Repeat the process for **LAN2**.
7. Click on the  save icon and save the updated configuration back to the IP Office system.

# Chapter 9.

# On-Boarding

---

## 9. On-Boarding

On-boarding is a process through which you can register an IP500 V2 system for remote support and maintenance from Avaya. The process of on-boarding is done using the IP Office Web Manager interface.

This section is a short summary of on-boarding. For full details on configure and administer SSL VPN services, see the Avaya IP Office SSL VPN Solutions Guide. You can download the guide from <http://support.avaya.com>.

### Summary Steps

1. Login to IP Office Web Manager

2. **On-Board the System**

This process has 3 main steps:

a. **Obtain an Inventory File**

From the system export a file that contains an inventory of the equipment within the system. This file is required in order to register the system for support.

b. **Register the System**

Register the system on the Avaya Global Registration Tool website and upload the system's inventory file. Once the system is registered, an on-boarding file is provided for the system. This file contains configuration settings for the SSL VPN service link.

c. **Upload an On-Boarding File**

Upload the on-boarding file to the system. The information within the file is used to update the system's configuration.

### Configuration Changes Caused by On-Boarding

When an on-boarding file is uploaded to the IP500 V2 system, it can make a number of changes to the system configuration. It is important to be aware of these potential changes and to ensure that they are not subsequently overwritten or removed.

The changes are as follows. Those marked \* are optional and depend on the settings included in the on-boarding file by the service provider.

- **SSL VPN Service**  
A new SSL VPN service is added to the Services section of the configuration.
- **SNMP Alarms\***  
SNMP can be configured and two SNMP alarm traps added to the configuration. Note that this will overwrite any existing SNMP settings if SNMP has already been configured.
- **Short Codes\***  
Short codes can be added using the Set Hunt Group Night Service and Clear Hunt Group Night Service actions. These can be used to enable and disable the SSL VPN service.
- **IP Route\***  
A static IP route to the SSL VPN service can be added to the IP routes in the configuration.
- **Security Certificate**  
A security certificate for the SSL VPN service is added to the system's security settings.

## 9.1 On-Boarding

1. Login to IP Office Web Manager.
  - a. Enter the system's IP address in the browser. Select **IP Office Web Manager**. Alternatively, enter *https://<IP\_Address>:8443/WebMgmtEE/WebManagement.html*.
  - b. Enter an administrator user name and password and click **Login**.
2. Click **Actions** and select **On-boarding**. The On-boarding menu is displayed.
  - **Are you using TAA series hardware?**

Systems purchased under US Federal Acquisition Regulations (FAR) must comply with the requirements of the Trade America Act (TAA). For various items of IP Office hardware there are TAA compatible variants. Select this option if the IP Office system includes TAA hardware. This is usually indicated by TAA appearing on the label on the back of the system control unit.
3. Click **Get Inventory File** to download an inventory.xml file for the system. When you register the IP Office system for remote support, the inventory file is required as part of the registration and is uploaded to the Avaya Global Registration Tool (GRT) where the inventory data is populated in the Avaya Customer Support (ACS) database.
4. Click **Register IP Office** to register the system with the the Avaya Global Registration Tool (GRT) website.
5. Once the system is registered, you can download an on-boarding file for the system from the Avaya Global Registration Tool website. This file contains the settings required to establish an SSL VPN connection between the IP Office system and an Avaya VPN Gateway (AVG) server.
6. Use the **On-boarding File Upload** section to upload the on-boarding file to the system.





# Chapter 10.

# SD Card Management

## 10. SD Card Management

This chapter is currently set for standard mode only as it covers the thick clients.

The IP500 V2 control unit has two SD card slots, labeled **System SD** and **Optional SD** respectively. These are used as follows:

- **System SD Card**

An Avaya System SD card must be present in this slot at all times. This card holds copies of the IP Office firmware and configuration and is used as the IP500 V2 control units non-volatile memory.

- Each Avaya System SD card has a unique serial number which is used for generating and validating licenses.
- The card stores the prompts for Embedded Voicemail operation and acts as the message store for Embedded Voicemail messages.
- Prior to any planned shutdown or restart of the IP Office system, the current configuration running in the IP Office system's RAM memory is copied to the **/primary** folder on the System SD card and to the systems non-volatile memory.
- Following a restart, the software in the **/primary** folder is loaded by the IP500 V2 control unit. If the required software is not present or valid a sequence of fallback options is used, see [Booting from the SD Cards](#)<sup>[124]</sup> for full details.
- Following a restart, if present, the configuration file in the **/primary** folder is loaded by the IP500 V2 control unit. If no file is present the system will check for a file in its internal non-volatile memory. If no copy is found it will generate a default configuration file. See [Booting from the SD Cards](#)<sup>[124]</sup> for full details.
- Once each day (approximately between 00:00 and 00:30) the IP Office will copy the current configuration running in its RAM memory to the **/primary** folder on the card.
- Configuration changes made using IP Office Manager are first written to the copy of the configuration file on the card and then merged with the configuration running in the IP Office system's RAM memory.
- The write lock setting on cards in the System SD card slot is ignored.

- **Optional SD Card**

A card does not have to be present in this slot for normal IP Office operation. The slot can be used for various maintenance actions.

- A card with an updated IP Office software or configuration can be inserted and those files then transferred to the System SD card in order to upgrade the IP Office system.
- The full contents of the System SD card can be copied to the Optional SD card while the IP Office system is running.
- The write lock setting on cards in the Optional SD card slot is honored.



### Card Removal

Memory cards should always be [shutdown](#)<sup>[140]</sup> before being removed when the system is running. Though the card slot LEDs indicate when data is being written to an card, lack of flashing LED is not a sufficient safeguard. Shutting down the card disables Embedded Voicemail and IP Office Web Manager. If the **System SD** card is removed, features licensed by the card's serial number continue operating for up to 2 hours.

### Card Specification

Non-Avaya cards can be used in the **Optional SD** slot as long as they match or exceed the standard below:

- SDHC 4GB minimum Class 2+. Single partition FAT32 format.

## SD Card Folders

The **System SD** card **/system** folder contains the following sub-folders:

- **/primary**  
Contains the firmware files for the IP Office control unit, external expansion modules and supported phones. The folder can also contain music on hold files and license key files. This is the main set of files used by the IP Office system when booting up. Also contains the stored copy of the IP Office configuration.
- **/backup**  
Contains a copy of the primary folder at some previous point. A backup copy of the primary contents to this folder can be invoked manually (using IP Office Manager or SSA) or as part of the IP Office software upgrade using IP Office Manager.
- **/backup\_apl**
- **/lvmail**  
Contains the system prompts used by Embedded Voicemail. Note that the mailbox messages and greetings are stored in a sub-folder of the **/dynamic** folder.
  - The sub-folder **/AAG** is used to store Embedded Voicemail auto-attendant greetings.
- **/doc**  
Contains initial installation documentation for the system.
- **/dynamic**  
Contains files used by the IP Office and retained through a reboot of the IP Office system.
  - The sub-folder **/lvmail** is used to store individual user and group mailbox messages, name recordings and announcements. The storage capacity for Embedded Voicemail is limited to 25 hours regardless of the capacity of the card.
- **/temp**  
Contains temporary files used by the IP Office and not retained through a reboot of the IP Office system.
- **/ws**

The **Optional SD** card can contain a similar set of folders. These are used as an additional backup or they can be used as the source for upgrading the contents of the System SD card.

---

## 10.1 Booting from the SD Cards

When being powered up, the IP500 V2 control unit looks for a valid ip500v2.bin binary file to load. It does this using the possible source below in the order shown, skipping to the next source if the file is not present or is not valid.

1. System SD card **/primary** folder.
2. The control unit's own internal non-volatile memory. Once a system has been installed, it uses its non-volatile memory to keep copies of the configuration and system binary files it is using. These can be used to restore operation during a system reboot. Note that though a system can boot from non-volatile memory, a System SD card must still be present for correct system operation.
3. System SD card **/backup** folder.
4. Optional SD card **/primary** folder.
5. Optional SD card **/backup** folder.
6. If no file is found, the control unit will fallback to making BOOTP requests to the network. IP Office Manager can respond the BOOTP request. See [Erasing the Operational Firmware](#)<sup>[186]</sup>.

Once a valid ip500v2.bin file is found, the IP Office control unit will load that firmware. The source from which the control unit binary file was loaded is then used to load further files.

### Configuration File Loading

Having installed the necessary system firmware files as above, the IP500 V2 control unit requires a configuration file:

- If the IP500 V2 booted using binary files from an SD card location, it looks for a valid configuration file in the same location.
  - If a configuration file is present and valid, it is loaded.
  - If a configuration file is present but is not valid, load the configuration copy in its non-volatile memory if present, else it assumes a default configuration.
  - If a configuration file is not present, use the non-volatile memory copy as above unless the reboot is as a result of a default system command.
- If the IP500 V2 booted using binary files from its non-volatile memory, it will also load the configuration copy from that location.
  - It will indicate a boot alarm (see below).
  - It will attempt to restore the firmware file in the System SD card's **/primary** folder using the copy in its non-volatile memory.
  - The normal boot up process of upgrading expansion module firmware does not occur. If the **File | Advanced | Upgrade** command is used, only external expansion modules actually present in the system are listed for upgrade.

### Post Boot Operation

During normal operation, configuration and binary files sent to the System SD card **/primary** folder using IP Office Manager are also written to the non-volatile memory.

If the system has booted from its non-volatile memory due to an SD card problem, it is still possible to upgrade the ip500v2.bin file using the IP Office upgrade wizard.

## Boot Alarms

The following apply if the IP500 V2 boots using software other than that in its System SD **/primary** folder:

- An alarm will be shown in the System Status Application. It will also generate an alarm if the card in any slot is not compatible. These alarms are also output as SNMP, Syslog or email alarms.
- The IP Office Manager **Select IP Office** menu will display an  icon indicating that the IP Office system is running using software other than from the System SD card's primary folder.
- The configuration can be read but will be read only. Attempting to send a configuration to the system will cause the error message **Failed to save configuration data. (Internal error)**.

## Bypassing the System SD Card Primary Folder

The control unit can be forced to bypass the System SD card's **/primary** folder and non-volatile memory when starting. This is done by pressing the **Aux** button while applying power to the control unit.

This action may be necessary if, following an upgrade of the IP Office system, it is determined that a roll back to the previously backed up firmware and configuration is required. Using the **Aux** button should restore system operation using the **/backup** folder files while the installer then restores the contents of the **/primary** folder to a previous release.

---

## 10.2 Creating an IP Office SD Card

The processes below can be applied to Avaya IP Office SD cards. They can also be applied to non-Avaya SD cards for use in a system's Optional SD card slot. For the System SD slot, only Avaya System SD cards should be used.

The card must be the following format.

- SDHC 4GB minimum Class 2+. Single partition FAT32 format.
-  **WARNING**  
Avaya supplied SD cards should not be formatted using any other method than the format commands within IP Office Manager and System Status Application. Formatting the cards using any other method removes the serial number used for IP Office licensing from the card.
- **! Warning: IP Office Manager Version**  
This process uses software files provided by the installed version of IP Office Manager being used. You must ensure that the version of IP Office Manager used matches the version of software required.

### Creating a Card on a Local PC

These processes can be run on an SD card inserted in a card reader on the IP Office Manager PC. That card can then be used in the System SD card slot of a new system or in the Optional SD card slot of an existing system to upgrade that system.

### Formatting an SD Card

Avaya SD cards should only be formatted using the format options provided within IP Office applications. This process is not normally necessary with Avaya SD cards unless you suspect that the card has been incorrectly formatted elsewhere.

-  **WARNING: All File Will Be Erased**  
Note that this action will erase any existing files and folders on the card. Once a card has been formatted, the folders and files required for IP Office operation can be loaded onto the card from the IP Office Manager PC using the Recreate IP Office SD Card command.
1. Insert the SD card into a reader slot on the IP Office Manager computer.
  2. Using IP Office Manager, select **File | Advanced | Format IP Office SD Card**.
  3. Select **IP Office A-Law**, **IP Office U-Law**, **IP Office Partner Edition** or **IP Office Norstar Edition**. This selection just sets the card label shown when viewing the card details. It does not affect the actual formatting. Select the label that matches the files set you will be placing on the card.
  4. Browse to the card location and click **OK**.
  5. The status bar at the bottom of IP Office Manager will display the progress of the formatting process.
  6. When the formatting is complete, you can use the **Recreate IP Office SD Card** command to load the IP Office folders and files onto the card from the IP Office Manager PC.

## Recreating an IP Office SD Card

This command can be used with a read-writeable SD card on the IP Office Manager PC. It copies the files and folders used by an IP500 V2 system when starting. It updates the card with the version of those files installed with the IP Office Manager application. It includes the binary files for the IP500 V2 system, external expansion modules and phones. It also includes the prompt files for Embedded Voicemail operation.

- **! WARNING: Installing PCS14 and earlier control units**

[PCS](#) 14 or lower units must first install Release 8.1(65) (or higher 8.1) or any Release 9.0 and then upgrade to Release 9.1. Care should be taken to ensure that no calls are made before the upgrade to Release 9.1, otherwise the system will require an 9.1 upgrade license despite being "new". The PCS of the control unit is printed on the label on the back of the control unit.

This process replaces existing files and adds new files. It does not delete files, so for example, any existing Embedded Voicemail messages and greetings are retained. If the card contains dynamic system files such as SMDR records, they are temporarily backed up by IP Office Manager and then restored after the card is recreated.

For the card to be used in an IP500 V2 system's **System SD** slot the card must be Avaya System SD card. The card must be correctly formatted, however a reformat of an existing working card is not necessary before using recreate to update the card contents.

- The source for the files copied to the SD card are the sub-folders of the **\Memory Cards** folder under Manager's applications **Working Directory** (normally **C:\Program Files Avaya\IP Office\Manager**). However, if the Working Directory is changed to a location without an appropriate set of **\Memory Cards** sub-folders, the required set of files will not be copied onto the SD card.

## To upgrade a System SD card

1. Once started do not interrupt this process, for example by removing the SD card. This process takes approximately 15 minutes.
2. Insert the SD card into a card reader on the IP Office Manager PC.
3. Using IP Office Manager, select **File | Advanced | Recreate IP Office SD Card**.
4. Select **IP Office A-Law**, **IP Office U-Law**, **IP Office Partner Edition**, or **IP Office Norstar Edition**. This selection will affect how the IP Office systems operates when defaulted with this card present in its **System SD** card slot.
5. Browse to the card location and click **OK**.
6. IP Office Manager will prompt whether you want to include Avaya IP Office Web Manager files as part of the recreate process. Those files are necessary if you want to run IP Office Web Manager to manage the IP Office system into which the card will be loaded or if you want to use [on-boarding](#).
7. IP Office Manager will start creating folders on the SD card and copying the required files into those folders. This process will take approximately 15 minutes.
8. Do not remove the SD card during the process. Wait until the IP Office Manager displays a message.



## 10.3 Viewing the Card Contents

Using IP Office Manager you can view the folders and files on the System SD card and the Optional SD card. You can then use various commands to upload and download files to and from the cards.

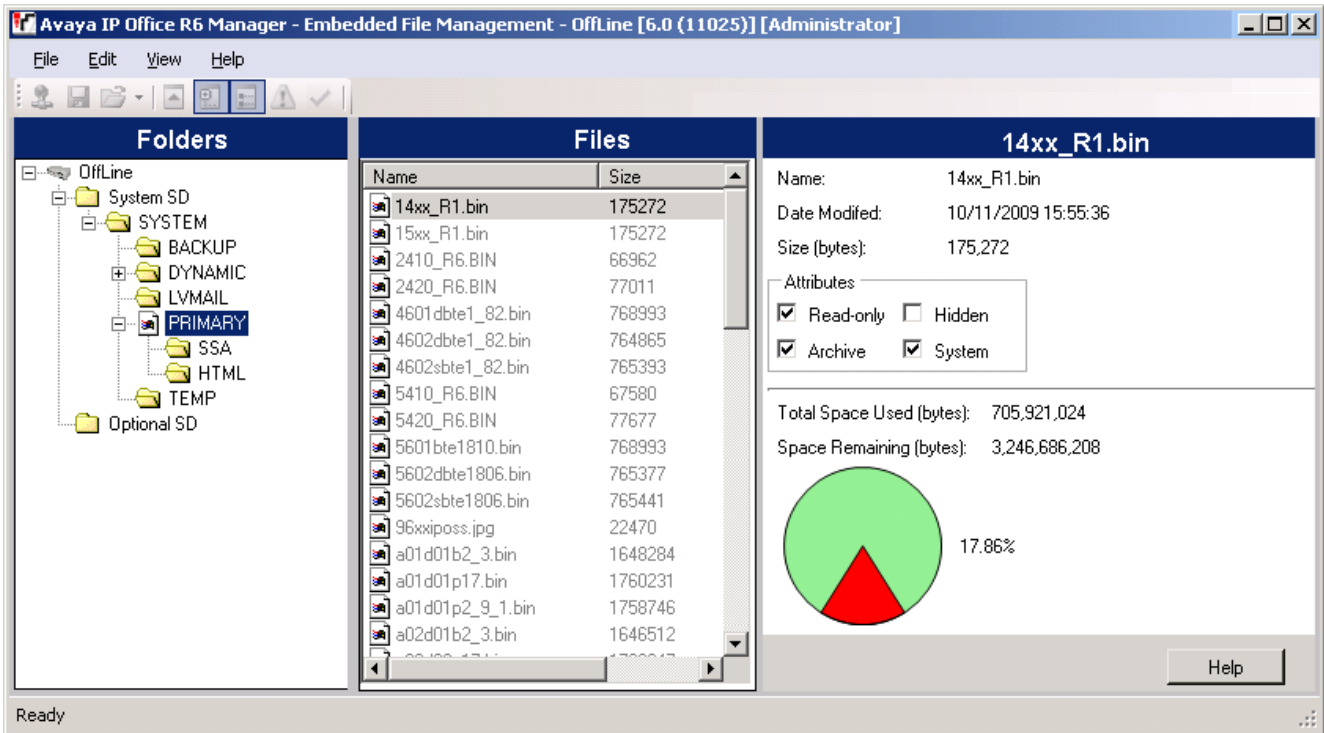

1. Using IP Office Manager, select **File | Embedded File Management**.
2. Using the **Select IP Office** menu, select the IP Office system.
3. The file contents of the memory cards are displayed.



## 10.4 Backing Up to the Backup Folder

This process copies the contents of the **/primary** folder on the System SD card over the **/backup** folder on the same card. Any files with matching file names are replaced. This takes approximately 6 minutes. For methods to restore from the **/backup** folder see [Restore from the Backup Folder](#)<sup>[130]</sup>.

These processes do not backup the prompts, messages and greetings used by the system's voicemail mailboxes and auto attendants. They are stored in the card's **/lvmail** and **/dynamic/lvmail** folders.

### Process Options

1. [Backing up to the /backup folder using IP Office Manager](#)<sup>[129]</sup>
2. [Backing up to the /backup folder using System Status Application](#)<sup>[129]</sup>
3. [Backing up to the /backup folder using a System Phone](#)<sup>[129]</sup>
4. [Backing up to the /backup folder using IP Office Web Manager](#)<sup>[130]</sup>

### 10.4.1 Backup to the Backup Folder Using IP Office Manager

#### To backup to the /backup folder using IP Office Manager

1. Using IP Office Manager, select **File | Embedded File Management**.
2. Using the **Select IP Office** menu, select the IP Office system.
3. The file contents of the memory cards are displayed.
4. Select **File | Backup System Files**.
  - The contents of the **/primary** folder on the System SD card will be copied to the **/backup** folder. This process takes approximately 6 minutes.

### 10.4.2 Backup to the Backup Folder Using System Status Application

#### To backup to the /backup folder using the System Status Application

1. Start [System Status](#)<sup>[70]</sup> and access the IP Office's status output.
2. In the navigation panel select **System**.
3. At the bottom of the screen select **Backup System Files**.
  - The contents of the **/primary** folder on the System SD card will be copied to the **/backup** folder. This process takes approximately 6 minutes.

### 10.4.3 Backup to the Backup Folder Using a System Phone

This process can be used by a user configured as a System Phone user and using a 1400, 1600, 9500 or 9600 Series phone (excluding XX01, XX02 and XX03 models). The user's **Login Code** is used to restrict access to the system administration functions on the phone.

#### To backup to the /backup folder using a System Phone

1. Select **Features | Phone User | System Admin**.
2. Enter your IP Office user login code.
3. From the menu select **Memory Card**.
4. Select **System Backup**.
  - The contents of the **/primary** folder on the System SD card will be copied to the **/backup** folder. This process takes approximately 6 minutes.

---

## 10.4.4 Backup to the Backup Folder Using a IP Office Web Manager

### To backup to the /backup folder using IP Office Web Manager

1. Login to IP Office Web Manager.
  - a. Enter the system's IP address in the browser. Select **IP Office Web Manager**. Alternatively, enter `https://<IP_Address>:8443/WebMgmtEE/WebManagement.html`.
  - b. Enter an administrator user name and password and click **Login**.
2. Click **Actions** and select **Backup**.
2. For the destination select **On Device**.
3. Click **Backup**.

## 10.5 Restoring from the Backup Folder

The contents of the **/backup** folder on the System SD card can be copied to the **/primary** folder on the same card. Any files with matching file names are replaced. The system then restarts using the files in the **/primary** folder.

- **! WARNING**

This process requires the IP Office system to reboot in order to complete the changes. The reboot ends all current calls and services.

### Process Options

1. [Restoring from the /backup folder using IP Office Manager](#)<sup>[130]</sup>
2. [Restoring from the /backup folder using System Status Application](#)<sup>[130]</sup>
3. [Restoring from the /backup folder using a System Phone](#)<sup>[130]</sup>
4. [Restoring from the /backup folder using IP Office Web Manager](#)<sup>[130]</sup>

### 10.5.1 Restoring from the Backup Folder Using IP Office Manager

#### To restore from the /backup folder using IP Office Manager

1. Using IP Office Manager, select **File | Embedded File Management**.
2. Using the **Select IP Office** menu, select the IP Office system.
3. The file contents of the memory cards are displayed.
4. Select **File | Restore System Files**.
  - The contents of the **/backup** folder on the System SD card are copied to the **/primary** folder. The process takes approximately 6 minutes.
  - When the process has been completed, the system restarts.

### 10.5.2 Restoring from the Backup Folder Using System Status Application

#### To restore from the /backup folder using System Status Application

1. Start [System Status](#)<sup>[70]</sup> and access the IP Office's status output.
2. In the navigation panel select **System**.
3. At the bottom of the screen select **Restore System Files**.
  - The contents of the **/backup** folder on the System SD card are copied to the **/primary** folder. The process takes approximately 6 minutes.
  - When the process has been completed, the system restarts.

### 10.5.3 Restoring from the Backup Folder Using a System Phone

This process can be used by a user configured as a System Phone user and using a 1400, 1600, 9500 or 9600 Series phone (excluding XX01, XX02 and XX03 models). The user's **Login Code** is used to restrict access to the system administration functions on the phone.

#### To restore from the /backup folder using a System Phone

1. Select **Features | Phone User | System Admin**.
2. Enter your IP Office user login code.

3. From the menu select **Memory Card**.

4. Select **System Restore**.

- The contents of the **/backup** folder on the System SD card are copied to the **/primary** folder. The process takes approximately 6 minutes.
- When the process has been completed, the system restarts.

## 10.5.4 Restoring from the Backup Folder Using IP Office Web Manager

### To restore from the **/backup** folder using IP Office Web Manager

1. Login to IP Office Web Manager.

a. Enter the system's IP address in the browser. Select **IP Office Web Manager**. Alternatively, enter *https://<IP\_Address>:8443/WebMgmtEE/WebManagement.html*.

b. Enter an administrator user name and password and click **Login**.

2. Click **Actions** and select **Restore**.

2. For the destination select **On Device**.

3. Click **Restore**.



## 10.6 Backing Up to the Optional SD Card

This process copies all files on the System SD card to the Optional SD card. It includes the **/primary** and **/backup** folders and the Embedded Voicemail files including message files. Any matching files and folders on the Optional SD card are overwritten.

The process is a simple copy. Any files already copied that change while the process are not recopied. Any new files added while the process is running, for example voicemail messages, may not be copied.

This process takes at least 90 minutes and may take much longer depending on the amount of data to be copied, for example it will be longer if Embedded Voicemail is being used by the IP Office system to take messages.

### Process Options

1. [Backing up to the Optional SD Card using IP Office Manager](#)<sup>[133]</sup>
2. [Backing up to the Optional SD Card using System Status Application](#)<sup>[133]</sup>
3. [Backing up to the Optional SD Card using IP Office Web Manager](#)<sup>[134]</sup>
4. [Backing up to the Optional SD Card using a System Phone](#)<sup>[134]</sup>

### 10.6.1 Backing Up to the Optional SD Using IP Office Manager

#### To backup the System SD card to the Optional SD card using IP Office Manager

1. Using IP Office Manager, select **File | Embedded File Management**.
2. Using the **Select IP Office** menu, select the IP Office system.
3. The file contents of the memory cards are displayed.
4. Select **File | Copy System Card**.
  - The contents of the System SD card will be copied to the Optional SD card. This process at least 90 minutes and can take much longer.

### 10.6.2 Backing Up to the Optional SD Using System Status Application

#### To backup the System SD card to the Optional SD card using System Status Application

1. Start [System Status](#)<sup>[70]</sup> and access the IP Office's status output.
2. In the navigation panel select **System**.
3. Select **Memory Cards**.
4. Select **System Card**.
5. At the bottom of the screen select **Copy System Card**.
  - The contents of the System SD card will be copied to the Optional SD card. This process at least 90 minutes and can take much longer.

---

### 10.6.3 Backing Up to the Optional SD Using IP Office Web Manager

#### To backup the System SD card to the Optional SD card using IP Office Web Manager

1. Login to IP Office Web Manager.
  - a. Enter the system's IP address in the browser. Select **IP Office Web Manager**. Alternatively, enter *https://<IP\_Address>:8443/WebMgmtEE/WebManagement.html*.
  - b. Enter an administrator user name and password and click **Login**.
2. Click **Actions**. Select **Service Commands** and select **Copy to Optional SD**.
3. Click **OK**.

### 10.6.4 Backing Up to the Optional SD Using a System Phone

This process can be used by a user configured as a System Phone user and using a 1400, 1600, 9500 or 9600 Series phone (excluding XX01, XX02 and XX03 models). The user's **Login Code** is used to restrict access to the system administration functions on the phone.

#### To backup the System SD card to the Optional SD card using a System Phone

1. Select **Features | Phone User | System Admin**.
2. Enter your IP Office user login code.
3. From the menu select **Memory Card**.
4. Select **Copy**.
  - The contents of the System SD card will be copied to the Optional SD card. This process at least 90 minutes and can take much longer.

## 10.7 Restoring a Configuration from an Optional Card

The following processes copy the configuration file (*config.cfg*) and licenses file (*keys.txt*). The processes take a few seconds.

- **! WARNING**

This process requires the IP Office system to reboot in order to complete the changes. The reboot ends all current calls and services.

### Process Options

1. [Restoring from the Optional SD Using IP Office Manager](#)<sup>[135]</sup>
2. [Restoring from the Optional SD Using a System Phone](#)<sup>[135]</sup>

### 10.7.1 Restoring from the Optional SD Using IP Office Manager

#### To copy a configuration file from the Optional SD card using IP Office Manager

1. Using IP Office Manager, select **File | Embedded File Management**.
2. Using the **Select IP Office** menu, select the IP Office system.
3. The file contents of the memory cards are displayed.
4. Select **File | Upgrade Configuration**.
  - The configuration file (*config.cfg*) and licenses file (*keys.txt*) in the */primary* folder on the Optional SD card are copied to the */primary* folder on the System SD card. This process takes approximately a few seconds.
  - When the process has been completed, the IP Office system will be restarted.

### 10.7.2 Restoring from the Optional SD Using a System Phone

This process can be used by a user configured as a System Phone user and using a 1400, 1600, 9500 or 9600 Series phone (excluding XX01, XX02 and XX03 models). The user's **Login Code** is used to restrict access to the system administration functions on the phone.

#### To copy a configuration file from the Optional SD card using a System Phone

1. Select **Features | Phone User | System Admin**.
2. Enter your IP Office user login code.
3. From the menu select **Memory Card**.
4. Select **Upgrade Config...**.
  - The configuration file (*config.cfg*) and licenses file (*keys.txt*) in the */primary* folder on the Optional SD card are copied to the */primary* folder on the System SD card. This process takes approximately a few seconds.
  - When the process has been completed, the IP Office system will be restarted.

---

## 10.8 Loading Software from an Optional SD Card

These processes copy all files in the folder except the configuration file (**config.cfg**) and licenses file (**keys.txt**). The processes take approximately 5 minutes. These process do not restore Embedded Voicemail prompts (see [Upgrading Card Software](#)<sup>[139]</sup>).

- **! IP Office Technical Bulletins**

You must obtain and read the IP Office Technical Bulletin relating to the IP Office software release which intend to install. The bulletin contains important information that may not have been included in this manual. IP Office Technical Bulletins are available from the [Avaya support](http://support.avaya.com) website (<http://support.avaya.com>).

- **! Upgrade Licenses**

Some upgrades may require entry of upgrade licenses. It is still possible to upgrade the system without the necessary licenses, however the system will not provide any telephony functions after the upgrade until the appropriate license is added to the system configuration.

- **! WARNING**

This process requires the IP Office system to reboot in order to complete the changes. The reboot ends all current calls and services.

### Process Options

1. [Loading software from the Optional SD card using IP Office Manager](#)<sup>[136]</sup>
2. [Loading software from the Optional SD card using a system phone](#)<sup>[136]</sup>

### 10.8.1 Loading Software from the Optional SD Using IP Office Manager

#### To copy software files from the Optional SD card using IP Office Manager

1. Using IP Office Manager, select **File | Embedded File Management**.
2. Using the **Select IP Office** menu, select the IP Office system.
3. The file contents of the memory cards are displayed.
4. Select **File | Upgrade Binaries**.
  - The software files (all files in the folder except the configuration file (**config.cfg**) and licenses file (**keys.txt**)) in the **/primary** folder on the Optional SD card are copied to the **/primary** folder on the System SD card. This process takes approximately 5 minutes.
  - When the process has been completed, the IP Office system will be restarted.

### 10.8.2 Loading Software from the Optional SD Using a System Phone

This process can be used by a user configured as a System Phone user and using a 1400, 1600, 9500 or 9600 Series phone (excluding XX01, XX02 and XX03 models). The user's **Login Code** is used to restrict access to the system administration functions on the phone.

#### To copy software files from the Optional SD card using a System Phone

1. Select **Features | Phone User | System Admin**.
2. Enter your IP Office user login code.
3. From the menu select **Memory Card**.
4. Select **Upgrade Binaries...**
  - The software files (all files in the folder except the configuration file (**config.cfg**) and licenses file (**keys.txt**)) in the **/primary** folder on the Optional SD card are copied to the **/primary** folder on the System SD card. This process takes approximately 5 minutes.
  - When the process has been completed, the IP Office system will be restarted.



## 10.9 Backing Up to a PC

This process copies the **/backup** folder on the System SD card to a folder specified on the PC running IP Office Web Manager. This process takes approximately 25 minutes.

Before using this process, the contents of the **/Backup** folder can be updated with the files from the **/primary** folder on the same card. See [Backing Up to the Backup Folder](#)<sup>129</sup>.

### To backup to a PC using IP Office Web Manager

1. Login to IP Office Web Manager.
  - a. Enter the system's IP address in the browser. Select **IP Office Web Manager**. Alternatively, enter `https://<IP_Address>:8443/WebMgmtEE/WebManagement.html`.
  - b. Enter an administrator user name and password and click **Login**.
2. Click **Actions** and select **Backup**.
3. For the destination select **Client Machine**.
4. Click **Configure Path**.
5. Select the location for the backup and click **Open**. We recommend that you create a new folder and then select that folder.
6. Click **Start Backup**.
7. Wait until a backup completed message is displayed. Click **Cancel** to close the menu.

## 10.10 Restoring from a PC

This process restores a previous backup, overwriting the **/primary** folder on the System SD card.

- **! WARNING**

This process requires the IP Office system to reboot in order to complete the changes. The reboot ends all current calls and services.

### To restore from a PC backup using IP Office Web Manager

1. Login to IP Office Web Manager.
  - a. Enter the system's IP address in the browser. Select **IP Office Web Manager**. Alternatively, enter `https://<IP_Address>:8443/WebMgmtEE/WebManagement.html`.
  - b. Enter an administrator user name and password and click **Login**.
2. Click **Actions** and select **Restore**.
3. Click **Restore from** and select **Client Machine**.
4. Click **OK**.
5. Click **Configure Path**.
6. Select the folder containing the previous backup and click **Open**.
7. Click **Start Restore**.
8. Wait until a restore completed message is displayed. Click **Cancel** to close the menu. The system reboots.



## 10.11 Upgrading Card Software

In addition to using the traditional [IP Office Upgrade Wizard](#)<sup>[165]</sup>, IP500 V2 control units can be upgraded by loading the required set of firmware files onto the System SD card and rebooting the system.

- **! IP Office Technical Bulletins**

You must obtain and read the IP Office Technical Bulletin relating to the IP Office software release which intend to install. The bulletin contains important information that may not have been included in this manual. IP Office Technical Bulletins are available from the [Avaya support](http://support.avaya.com) website (<http://support.avaya.com>).

- **! Upgrade Licenses**

Some upgrades may require entry of upgrade licenses. It is still possible to upgrade the system without the necessary licenses, however the system will not provide any telephony functions after the upgrade until the appropriate license is added to the system configuration.

- **! WARNING**

This process requires the IP Office system to reboot in order to complete the changes. The reboot ends all current calls and services.

There are a number of ways in which this can be done.

Method	Description	Location	Software Files	Embedded Voicemail Prompts
<a href="#">Using IP Office Manager</a> <sup>[167]</sup>	Using IP Office Manager, the contents of the card are compared to the files that IP Office Manager has available and are upgraded if necessary.	<b>Local or Remote</b>	✓	✓
<a href="#">System SD Card Upgrade</a> <sup>[167]</sup>	In this method, the System SD card is shut down and removed from the control unit. The card's contents are upgraded using IP Office Manager.	<b>Local</b>	✓	✓
<a href="#">Upgrade from Optional SD Card</a> <sup>[168]</sup>	This method uses an SD card loaded with the required version of IP Office software. The card is inserted into the control unit's Option SD card slot and its contents copied to the System SD card.	<b>Local</b>	✓	–

---

## 10.12 Memory Card Shutdown/Removal

Before a memory card is removed from an IP Office system that is running, the card must be shutdown. Removing a memory card while the system is running may cause file corruption. Card services can be restarted by either reinserting the card or using a [Start Up command](#) <sup>[142]</sup>.

### Process Options

1. [Shutting down a memory card using IP Office Manager](#) <sup>[146]</sup>
2. [Shutting down a memory card using System Status Application](#) <sup>[146]</sup>
3. [Shutting down a memory card using IP Office Web Manager](#) <sup>[147]</sup>
4. [Shutting down a memory card using a system phone](#) <sup>[147]</sup>

### 10.12.1 Shutdown a Card Using IP Office Manager

#### To shutdown a memory card using IP Office Manager

1. Using IP Office Manager, select **File | Advanced | Memory Card Commands | Shutdown**.
2. Using the **Select IP Office** menu, select the IP Office system containing the memory card.
3. Click **OK**.
  - At the back of the control unit, confirm that the appropriate memory card LED is off.
  - The card can now be removed in order to perform the necessary maintenance actions.

### 10.12.2 Shutdown a Card Using System Status Application

#### To shutdown a memory card using System Status Application

1. Start [System Status](#) <sup>[70]</sup> and access the IP Office's status output.
2. In the navigation panel select **System**.
3. Select **Memory Cards**.
4. Select either **System Card** or **Optional Card**.
5. At the bottom of the screen select **Shutdown**.
  - At the back of the control unit, confirm that the appropriate memory card LED is off.
  - The card can now be removed in order to perform the necessary maintenance actions.

### 10.12.3 Shutdown a Card Using IP Office Web Manager

#### To shutdown a card using IP Office Web Manager

1. Login to IP Office Web Manager.
  - a. Enter the system's IP address in the browser. Select **IP Office Web Manager**. Alternatively, enter *https://<IP\_Address>:8443/WebMgmtEE/WebManagement.html*.
  - b. Enter an administrator user name and password and click **Login**.
2. Click **Actions**. Select **Service Commands** and select **Memory Card Stop**.
3. Select the card to stop and click **OK**.

### 10.12.4 Shutdown a Card Using a System Phone

This process can be used by a user configured as a System Phone user and using a 1400, 1600, 9500 or 9600 Series phone (excluding XX01, XX02 and XX03 models). The user's **Login Code** is used to restrict access to the system administration functions on the phone.

#### To shutdown a card using a System Phone

1. Select **Features | Phone User | System Admin**.
2. Enter your IP Office user login code.
3. From the menu select **Memory Card**.
4. Select **System** for the System SD card or **Option** for the Optional SD card.
5. Select **Shutdown**.
  - At the back of the control unit, confirm that the appropriate memory card LED is off.
  - The card can now be removed in order to perform the necessary maintenance actions.

---

## 10.13 Memory Card Startup

Reinserting a memory card into a system that is already switched on automatically restarts card operation. However, if the [card has been shutdown](#) <sup>[140]</sup> but not removed, it can be restarted using IP Office Manager without requiring a reboot.

### Process Options

1. [Starting a memory card using IP Office Manager](#) <sup>[142]</sup>
2. [Starting a memory card using System Status Application](#) <sup>[142]</sup>
3. [Starting a memory card using IP Office Web Manager](#) <sup>[142]</sup>
4. [Starting a memory card using a system phone](#) <sup>[142]</sup>

### 10.13.1 Startup a Card Using IP Office Manager

#### To startup a card using IP Office Manager

1. Using IP Office Manager, select **File | Advanced | Memory Card Commands | Startup**.
2. Using the **Select IP Office** menu, select the IP Office system containing the memory card.
3. Click **OK**.

### 10.13.2 Startup a Card Using System Status Application

#### To startup a card using System Status Application

1. Start [System Status](#) <sup>[70]</sup> and access the IP Office's status output.
2. In the navigation panel select **System**.
3. Select **Memory Cards**.
4. Select either **System Card** or **Optional Card**.
5. At the bottom of the screen select **Start Up**.

### 10.13.3 Startup a Card Using IP Office Web Manager

#### To startup a card using IP Office Web Manager

1. Login to IP Office Web Manager.
  - a. Enter the system's IP address in the browser. Select **IP Office Web Manager**. Alternatively, enter `https://<IP_Address>:8443/WebMgmtEE/WebManagement.html`.
  - b. Enter an administrator user name and password and click **Login**.
2. Click **Actions**. Select **Service Commands** and select **Memory Card Start**.
3. Select the card to start and click **OK**.

### 10.13.4 Startup a Card Using a System Phone

This process can be used by a user configured as a System Phone user and using a 1400, 1600, 9500 or 9600 Series phone (excluding XX01, XX02 and XX03 models). The user's **Login Code** is used to restrict access to the system administration functions on the phone.

#### To startup a card using a System Phone

1. Select **Features | Phone User | System Admin**.
2. Enter your IP Office user login code.
3. From the menu select **Memory Card**.
4. Select **System** for the System SD card or **Option** for the Optional SD card.
5. Select **Startup**.

# Chapter 11.

## Additional Processes

---

# 11. Additional Processes

This section covers a range of maintenance processes.

## Processes

- [Changing an IP Office Basic Edition system to standard mode](#) <sup>[145]</sup>
- [Switching off a system/System shutdown](#) <sup>[147]</sup>
- [Rebooting a system](#) <sup>[149]</sup>
- [Changing components](#) <sup>[151]</sup>
- [Defaulting the configuration](#) <sup>[154]</sup>
- [Default the security settings](#) <sup>[157]</sup>
- [Loading a new configuration file](#) <sup>[161]</sup>
- [Swapping extension users](#) <sup>[171]</sup>
- [Upgrading systems](#) <sup>[164]</sup>
- [Out of building telephone installation](#) <sup>[36]</sup>
- [Using the external output port](#) <sup>[176]</sup>
- [So8 BRI module configuration](#) <sup>[177]</sup>
- [SNMP configuration](#) <sup>[186]</sup>
- [Reset button](#) <sup>[184]</sup>
- [AUX button](#) <sup>[184]</sup>
- [RS232 port maintenance](#) <sup>[185]</sup>
- [Erasing the core software](#) <sup>[186]</sup>
- [Enabling IP Office Web Manager](#) <sup>[189]</sup>

## Other Processes

The following additional maintenance processes are covered in other sections of this document:

- [Creating an IP Office SD card](#) <sup>[126]</sup>
- [Viewing card contents](#) <sup>[126]</sup>
- [Backing up the configuration](#) <sup>[129]</sup>
- [Restoring the configuration](#) <sup>[136]</sup>
- [Copying to the Optional SD card](#) <sup>[133]</sup>
- [Restoring from the Optional SD card](#) <sup>[135]</sup>
- [Memory card shutdown/removal](#) <sup>[140]</sup>
- [Memory card startup](#) <sup>[142]</sup>
- [On-boarding](#) <sup>[118]</sup>
- [Installing the administration applications](#) <sup>[66]</sup>



## 11.1 Changing an IP Office Basic Edition System to Standard Mode

The process below will change the mode of the system and default its configuration.

- **! WARNING**

This process requires the IP Office system to reboot in order to complete the changes. The reboot ends all current calls and services.

1. Using IP Office Manager, receive the [configuration from the system](#)<sup>[69]</sup>.
2. When requested, enter the service user name and password.
3. The IP Office Manager application automatically switches to its simplified view as the configuration is from a system running in IP Office Basic Edition mode.
4. Select **File | Advanced | Switch to Standard Mode (Default)**.
5. The configuration changes to a default one for a IP Office Essential Edition system and IP Office Manager switches to its advanced view mode.
6. This is a suitable time to begin [initial configuration](#)<sup>[98]</sup> before sending the configuration back to the IP Office system to restart in IP Office Essential Edition.
  - For a system to run in IP Office Essential Edition or IP Office Preferred Edition mode, its configuration must include an **Essential Edition** license. A system without this license will not allow any telephony functions until the license is added.
7. Once the system has rebooted, use IP Office Manager to again receive the configuration from the system. The user name and password for configuration should be the IP Office Standard Version mode defaults **Administrator** and **Administrator**.

## 11.2 Automating the Change to Standard Mode

If the only systems that you install are ones using IP Office standard modes, IP Office Manager can be set to automatically default the system to IP Office standard mode.

- **! WARNING**

This process requires the IP Office system to reboot in order to complete the changes. The reboot ends all current calls and services.

1. In IP Office Manager, select **File | Preferences**.
2. On the **Preferences** sub-tab, enable **Default to Standard Mode**.

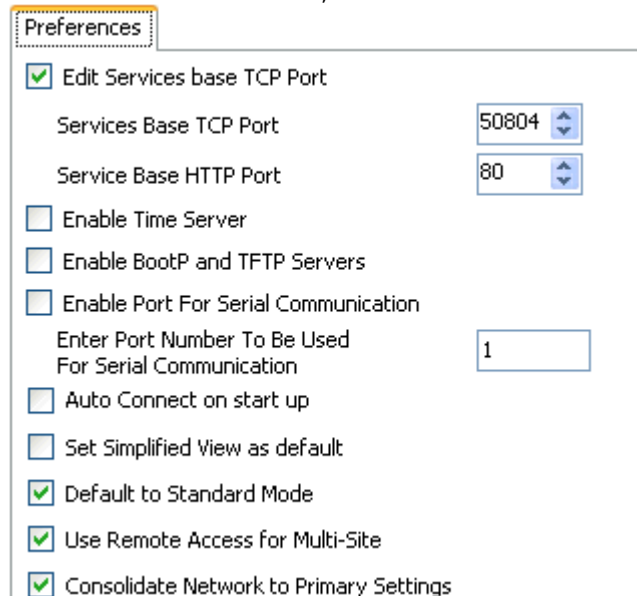

The screenshot shows the 'Preferences' dialog box in IP Office Manager. The 'Default to Standard Mode' checkbox is checked. Other settings include 'Services Base TCP Port' set to 50804, 'Service Base HTTP Port' set to 80, and 'Enter Port Number To Be Used For Serial Communication' set to 1. Other options like 'Enable Time Server', 'Enable BootP and TFTP Servers', 'Enable Port For Serial Communication', 'Auto Connect on start up', 'Set Simplified View as default', 'Use Remote Access for Multi-Site', and 'Consolidate Network to Primary Settings' are also visible.

3. With this option enabled, when a configuration for a new or defaulted system running in IP Office Basic Edition is received by IP Office Manager, it will automatically be converted to a IP Office Essential Edition configuration.

4. **! Important: IP Address Settings Default to Server**

The conversion will set the DHCP mode to **Server** and the LAN addresses to their defaults of 192.168.42.1 and 192.168.43.1. Using IP Office Manager to change these settings to the required values.

5. This is a suitable time to begin [initial configuration](#) <sup>[98]</sup> before sending the configuration back to the IP Office system to restart in IP Office Essential Edition.

- For a system to run in IP Office Essential Edition or IP Office Preferred Edition mode, its configuration must include an **Essential Edition** license. A system without this license will not allow any telephony functions until the license is added.

6. Sending the configuration back to the system restarts the system in IP Office Essential Edition mode.

## 11.3 Switching Off a System

Systems running IP Office Release 6.0 must be shut down in order to perform maintenance rather than just switched off. The shut down can be either indefinite or for a set period of time after which the IP Office will automatically reboot. Note that the control unit memory cards can be [shutdown](#)<sup>[140]</sup> and [restarted](#)<sup>[142]</sup> separately from the system.

During the shut down process, the current configuration in the control unit's RAM memory is copied to the control units non-volatile memory. For IP500 V2 systems that location is the System SD card.

- **! WARNING**

A shutdown must always be used to switch off the system. Simply removing the power cord or switching off the power input may cause the loss of configuration data.

- This is not a polite shutdown, any user calls and services in operation will be stopped. Once shutdown, the system cannot be used to make or receive any calls until restarted.
- The shutdown process takes up to a minute to complete. When shutting down a system with a Unified Communications Module installed, the shutdown can take up to 3 minutes while the card safely closes all open files and closes down its operating system.

- **Shutdown LED Indication**

When shutdown, the LEDs shown on the system are as follows. Do not remove power from the system or remove any of the memory cards until the system is in this state:

- LED1 on each IP500 base card installed will also flash red rapidly plus LED 9 if a trunk daughter card is fitted to the base card.
- The CPU LED on the rear of the system will flash red rapidly.
- The System SD and Optional SD memory card LEDs on the rear of the system are extinguished.

- **Restarting a System**

To restart a system when shutdown indefinitely, or to restart a system before the timed restart expires, switch power to the system off and on again.

### Process Options

1. [Shutting down a system using IP Office Manager](#)<sup>[147]</sup>
2. [Shutting down a system using System Status Application](#)<sup>[148]</sup>
3. [Shutting down a system using a System Phone](#)<sup>[148]</sup>
4. [Shutting down a system using the AUX button](#)<sup>[148]</sup>
5. [Shutting down a system using IP Office Web Manager](#)<sup>[148]</sup>

### 11.3.1 Shutdown a System Using IP Office Manager

#### To shutdown a system using IP Office Manager

1. Using IP Office Manager, select **File | Advanced | System Shutdown**.
2. Using the **Select IP Office** menu, the **System Shutdown Mode** menu is displayed.

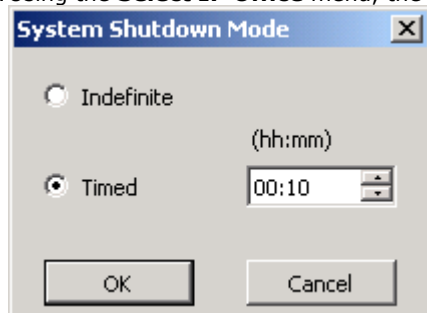

3. Select the type of shutdown required. If **Indefinite** is used, the system can only be restarted by having its power switched off and then on again. If a **Timed** shutdown is selected, the IP Office will reboot after the set time has elapsed.
4. Click **OK**.
5. Wait until the LEDs on the front of the system are all fast flashing red before performing any other actions.

---

## 11.3.2 Shutdown a System Using System Status Application

### To shutdown a system using System Status Application

1. Start [System Status](#) <sup>70</sup> and access the IP Office's status output.
2. In the navigation panel select **System**.
3. At the bottom of the screen select **Shutdown System**.
4. Select the time duration for the shutdown or indefinite.
5. Click **OK**.
6. Wait until the LEDs on the front of the system are all fast flashing red before performing any other actions.

## 11.3.3 Shutdown a System Using a System Phone

This process can be used by a user configured as a System Phone user and using a 1400, 1600, 9500 or 9600 Series phone (excluding XX01, XX02 and XX03 models). The user's **Login Code** is used to restrict access to the system administration functions on the phone.

Unlike IP Office Manager, a system phone user cannot select an indefinite shutdown. They can set a timed shut down of between 5 minutes and 24 hours.

### To shutdown a system using a system phone

1. Select **Features | Phone User | System Admin**.
2. Enter your IP Office user login code.
3. From the menu select **System Shutdown**.
4. Select a time period for the shutdown. It must be in between 5 minutes and 24 hours.
5. Press **Done** and then **Confirm** to begin the shutdown.
6. Wait until the LEDs on the front of the system are all fast flashing red before performing any other actions.

## 11.3.4 Shutdown a System Using the AUX Button

This method is supported by IP500 V2 control units.

### To shutdown a system using the IP500 V2 AUX Button

1. On the rear of the control unit, press and hold the **AUX** button for more than 5 seconds.
2. The control unit will shutdown with the restart timer set to 10 minutes.
3. Wait until the LEDs on the front of the system are all fast flashing red before performing any other actions.

## 11.3.5 Shutdown a System Using IP Office Web Manager

### To shutdown a system using IP Office Web Manager

1. Login to IP Office Web Manager.
  - a. Enter the system's IP address in the browser. Select **IP Office Web Manager**. Alternatively, enter *https://<IP\_Address>:8443/WebMgmtEE/WebManagement.html*.
  - b. Enter an administrator user name and password and click **Login**.
2. Click **Actions**. Select **Service Commands** and then **System Shutdown**.
3. Click **OK**.
4. Wait until the LEDs on the front of the system are all fast flashing red before performing any other actions.

## 11.4 Rebooting a System

It may occasionally be necessary to reboot the system. For example, after reinserting a System SD card with upgraded system software. That can be done using any of the following processes.

- **! WARNING**

One of the following methods should always be used to restart a system. Simply removing and then reapplying power to the system may cause the loss of data and unexpected system operation.

### Process Options

1. [Reboot a system using IP Office Manager](#) <sup>[149]</sup>
2. [Reboot a system using IP Office Web Manager](#) <sup>[150]</sup>
3. [Reboot a system using the Reset button](#) <sup>[150]</sup>
4. [Reboot a system using a system phone](#) <sup>[150]</sup>

### 11.4.1 Reboot a System Using IP Office Manager

#### To reboot a system using IP Office Manager

1. Using IP Office Manager, select **File | Advanced | Reboot**.
2. Use the **Select IP Office** menu to locate and select the IP Office system. Enter a valid user name and password.
3. The type of reboot can then be selected.

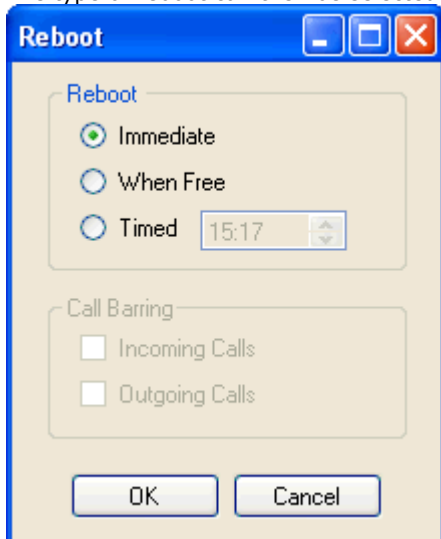

- **Reboot**

Select when the reboot should occur.

- **Immediate**

Reboot the system immediately.

- **When Free**

Reboot the system when there are no calls in progress. This mode can be combined with the **Call Barring** options.

- **Timed**

The same as When Free but waits for a specific time after which it then wait for there to be no calls in progress. The time is specified by the **Reboot Time**. This mode can be combined with the **Call Barring** options.

- **Reboot Time**

This setting is used when the reboot mode **Timed** is selected. It sets the time for the IP Office reboot. If the time is after midnight, the IP Office's normal daily backup is canceled.

- **Call Barring**

These settings can be used when the reboot mode When Free is selected. They bar the sending or receiving of any new calls.

4. Click **OK**.

---

## 11.4.2 Reboot a System Using IP Office Web Manager

### To reboot a system using IP Office Web Manager

1. Login to IP Office Web Manager.
  - a. Enter the system's IP address in the browser. Select **IP Office Web Manager**. Alternatively, enter *https://<IP\_Address>:8443/WebMgmtEE/WebManagement.html*.
  - b. Enter an administrator user name and password and click **Login**.
2. Click **Actions**. Select **Service Commands** and then **Reboot**.
3. Select when the reboot should occur.
  - **Immediate**  
Reboot the system immediately.
  - **Free**  
Reboot the system when there are no calls in progress.
  - **Timed**  
Reboot the system at the set time.
4. Click **OK**.

## 11.4.3 Reboot a System Using the Reset Button

### To reboot a system using the Reset button

Use this process to reboot the system when free. Once invoked, the system bars any new incoming or outgoing calls until after the reboot.

1. On the rear of the control unit, press and hold the **Reset** button for between 5 to 10 seconds until the **CPU** led changes to steady orange.
2. When the **CPU** LED changes to steady orange, release the button.
  - If the **CPU** LED changed to flashing orange or red, keep the button held until the **CPU** LED changes to flashing green. Then release the button and reattempt the process once the CPU LED has returned to steady green.
3. Wait for the reboot to complete before performing any other actions.

## 11.4.4 Rebooting a System Using a System Phone

This function is not supported from system phones on system's running in IP Office standard mode.

## 11.5 Changing Components

Except for memory cards (see [Memory Card Removal](#)<sup>[146]</sup>), cards and external expansion modules must only be removed and added to an IP Office system when that system is [switched off](#)<sup>[147]</sup>.

In the sections below, the term component can refer to a card fitted into the IP Office or an external expansion module.

Note that for extension ports, by default both an extension entry and a user entry will exist in the IP Office configuration. Extension entries can be deleted without deleting the corresponding user entry. This allows retention of the user settings and association of the user with a different extension by changing that extensions **Base Extension** number to match the user's **Extension ID**.

### Processes

- [Like for like replacement](#)<sup>[152]</sup>
- [Higher capacity component replacement](#)<sup>[152]</sup>
- [Lower capacity component replacement](#)<sup>[152]</sup>
- [Adding a new component](#)<sup>[152]</sup>
- [Permanent removal of a component](#)<sup>[153]</sup>
- [Replacement with a different type of component](#)<sup>[153]</sup>

---

## 11.5.1 Like for Like Replacement

If replacing with a component of the same type, no configuration changes are necessary.

### To do a like for like replacement

1. [Shutdown the system](#) <sup>[147]</sup>.
2. Switch off power to the system.
3. Remove the card or external expansion module. Note the card slot or expansion port used as the replacement must be installed in the same position.
4. Install the replacement using the appropriate process for the type of component ([Fitting IP500 cards](#) <sup>[80]</sup>, [Adding External Expansion Modules](#) <sup>[88]</sup>).
5. Restart the IP Office system.

## 11.5.2 Higher Capacity Replacement

If replacing with a component of the same type but higher capacity, when restarted the IP Office will automatically create configuration entries for the new trunks or extensions/users.

### To replace a component with one of the same type but higher capacity

1. [Shutdown the system](#) <sup>[147]</sup>.
2. Switch off power to the system.
3. Remove the card or external expansion module. Note the card slot or expansion port used as the replacement must be installed in the same position.
4. Install the replacement using the appropriate process for the type of component ([Fitting IP500 cards](#) <sup>[80]</sup>, [Adding External Expansion Modules](#) <sup>[88]</sup>).
5. Restart the IP Office system.
6. Use IP Office Manager to configure the new trunks or extensions/users.

## 11.5.3 Lower Capacity Replacement

If replacing with a component of the same type but lower capacity, after restarting the IP Office the configuration will need to be edited to remove redundant entries.

### To replace a component with one of the same type but lower capacity

1. [Shutdown the system](#) <sup>[147]</sup>.
2. Switch off power to the system.
3. Remove the card or external expansion module. Note the card slot or expansion port used as the replacement must be installed in the same position.
4. Install the replacement using the appropriate process for the type of component ([Fitting IP500 cards](#) <sup>[80]</sup>, [Adding External Expansion Modules](#) <sup>[88]</sup>).
5. Restart the IP Office system.
6. Use IP Office Manager to delete the trunks or extensions/users that are no longer supported by the component installed.

## 11.5.4 Adding a New Component

If adding a new component to an available slot or port, when restarted the IP Office will automatically create configuration entries for the new trunks or extensions/users.

### To add a new component

1. [Shutdown the system](#) <sup>[147]</sup>.
2. Switch off power to the system.
3. Install the replacement using the appropriate process for the type of component ([Fitting IP500 cards](#) <sup>[80]</sup>, [Adding External Expansion Modules](#) <sup>[88]</sup>).
4. Restart the IP Office system.
5. Use IP Office Manager to configure the new trunks or extensions/users.



## 11.5.5 Permanent Removal

If permanently removing the component, the configuration will need to be edited to remove redundant trunk or extension/user entries.

### To permanently remove a component

1. [Shutdown the system](#)<sup>[147]</sup>.
2. Switch off power to the system.
3. Remove the card or external expansion module.
4. Restart the IP Office system.
5. Use IP Office Manager to delete the trunks or extensions/users in the configuration that relate to the component removed.
6. In the **Control Unit** section of the configuration, delete the entry for the component that is no longer present in the system.

## 11.5.6 Replacemnt with a Different Type

If replacing a component with one of a different type, the process should be divided into two stages.

1. First remove the existing component using the [Permanent Removal](#)<sup>[153]</sup> process and adjust the configuration and reboot.
2. Then install the new component using the [Adding a New Component](#)<sup>[152]</sup> process.

---

## 11.6 Defaulting the Configuration

The following processes erases the configuration held in the control unit's memory. That include both the current configuration being used in RAM memory and the backup configuration stored in non-volatile memory. Following this, the system restarts with a default configuration.

This process should be performed from a PC with a fixed IP address, directly connected to the control unit and with the system disconnected from any network. Following this process, the control unit's IP address defaults to 192.168.42.1.

- **Standard Mode systems**

For IP Office Release 7.0 and higher, IP500 V2 systems using **IP Office A-Law** or **IP Office U-Law** System SD cards default to IP Office Basic Edition mode. Loading the configuration switches IP Office Manager to simplified view. To change the system back to operating in IP Office standard mode, see [Changing the System to Standard Mode](#) <sup>[154]</sup>.

### Process Options

1. [Defaulting the configuration using IP Office Manager](#) <sup>[154]</sup>
2. [Defaulting the configuration using IP Office Web Manager](#) <sup>[154]</sup>
3. [Defaulting the configuration using the Reset button](#) <sup>[154]</sup>
4. [Defaulting the configuration using a system phone](#) <sup>[155]</sup>
5. [Defaulting the configuration using Debug](#) <sup>[155]</sup>
6. [Defaulting the configuration using the Boot Loader](#) <sup>[156]</sup>

### 11.6.1 Defaulting the Configuration Using IP Office Manager

Read and note the warnings regarding [defaulting the configuration](#) <sup>[154]</sup> before using this process.

#### To erase the configuration using IP Office Manager

1. Start IP Office Manager.
2. Select **File | Advanced | Erase Configuration (Default)**.
3. Select the system to be defaulted and click **OK**.
4. Enter an administration name and password and click **OK**.

### 11.6.2 Defaulting the Configuration Using IP Office Web Manager

Read and note the warnings regarding [defaulting the configuration](#) <sup>[154]</sup> before using this process.

#### To default the configuration using IP Office Web Manager

1. Login to IP Office Web Manager.
  - a. Enter the system's IP address in the browser. Select **IP Office Web Manager**. Alternatively, enter `https://<IP_Address>:8443/WebMgmtEE/WebManagement.html`.
  - b. Enter an administrator user name and password and click **Login**.
2. Click **Actions**. Select **Service Commands** and then **Erase Configuration**.
3. Click **OK**.
4. Wait until the system has rebooted before logging in again.

### 11.6.3 Defaulting the Configuration Using the Reset Button

Read and note the warnings regarding [defaulting the configuration](#) <sup>[154]</sup> before using this process.

#### To default the configuration using the Reset button

1. On the rear of the control unit, press and hold the **Reset** button for between 10 to 30 seconds until the **CPU** led changes to flashing orange.
2. When the **CPU** LED changes to flashing orange, release the button.
  - If the **CPU** LED changed to red, keep the button held until the **CPU** LED changes to flashing green. Then release the button and reattempt the process once the CPU LED has returned to steady green.
3. Wait for the reboot to complete before performing any other actions.

## 11.6.4 Default the Configuration Using a System Phone

This process is not supported by system phones for a system running in IP Office standard mode.

## 11.6.5 Defaulting the Configuration Using Debug

Read and note the warnings regarding [defaulting the configuration](#)<sup>[154]</sup> before using this process.

-  **WARNING**

Use of the RS232 port should only be performed if absolutely necessary and only if the actions cannot be completed using IP Office Manager or IP Office Web Manager. In all cases, you must make every effort to ensure that you have a backup copy of the system configuration.

### To erase the configuration using debug:

This process erases the IP Office's configuration settings but does not alter its security settings. It is easier to use than the boot loader method.

1. Ensure that you have a backup copy of the IP Office's configuration before performing this action. If a copy of the configuration cannot be downloaded using IP Office Manager, check the IP Office Manager application directory for previously downloaded configurations.
  - a. Use IP Office Manager to download an up to date copy of the configuration. If that is not possible, check in the IP Office Manager application folder for a previous copy of the configuration.
  - b. Using IP Office Manager, select **File | Open Configuration**.
  - c. Using the **Select IP Office Menu**, locate and select the IP Office system. Click **OK**.
  - d. Enter the name and password for a service user account on that IP Office. Click **OK**. IP Office Manager will receive and display the configuration from the IP Office.
    - If not already done, this action creates a BOOTP entry in IP Office Manager for the IP Office system.
    - This action also confirms communication between the IP Office Manager PC and the IP Office prior to any following process.
  - e. Select **File | Save Configuration As...** and save a copy of the configuration file onto the PC.
2. Attach the serial cable between the PC and the RS232 DTE port on the IP Office control unit.
  - a. Start the terminal program on your PC. Ensure that it has been setup as listed in [RS232 DTE Port Settings](#)<sup>[367]</sup>. Within a HyperTerminal session, the current settings are summarized across the base of the screen.
  - b. Enter **AT** (note upper case). The control unit should respond **OK**.
  - c. Enter **AT-DEBUG**. The control unit should response with the time and date and then **Hello>** to show it is ready to accept commands.
3. To erase the current configuration in RAM memory, enter **eraseconfig**. The **Hello>** command prompt reappears when the action is completed.
4. To erase the backup configuration stored in non-volatile Flash memory, enter **erasenvconfig**. The **Hello>** command prompt reappears when the action is completed.
5. To reboot the IP Office enter **reboot**. The IP Office will reboot and restart with a defaulted configuration.
6. Close the terminal program session.
7. IP Office Manager can now be used to alter and then upload an old configuration file or receive and edit the control unit's now defaulted configuration.

---

## 11.6.6 Defaulting the Configuration Using Boot Loader

Read and note the warnings regarding [defaulting the configuration](#)<sup>[154]</sup> before using this process.

- **⚠ WARNING**

Use of the RS232 port should only be performed if absolutely necessary and only if the actions cannot be completed using IP Office Manager or IP Office Web Manager. In all cases, you must make every effort to ensure that you have a backup copy of the system configuration.

### To erase the configuration and security settings using the Boot Loader

This process also defaults the IP Office security settings.

1. Ensure that you have a backup copy of the IP Office's configuration before performing this action. If a copy of the configuration cannot be downloaded using IP Office Manager, check the IP Office Manager application directory for previously downloaded configurations.
  - a. Use IP Office Manager to download an up to date copy of the configuration. If that is not possible, check in the IP Office Manager application folder for a previous copy of the configuration.
  - b. Using IP Office Manager, select **File | Open Configuration**.
  - c. Using the **Select IP Office Menu**, locate and select the IP Office system. Click **OK**.
  - d. Enter the name and password for a service user account on that IP Office. Click **OK**. IP Office Manager will receive and display the configuration from the IP Office.
    - If not already done, this action creates a BOOTP entry in IP Office Manager for the IP Office system.
    - This action also confirms communication between the IP Office Manager PC and the IP Office prior to any following process.
  - e. Select **File | Save Configuration As...** and save a copy of the configuration file onto the PC.
2. Attach the serial cable between the PC and the RS232 DTE port on the IP Office control unit.
  - a. Start the terminal program on your PC. Ensure that it has been setup as listed in [RS232 DTE Port Settings](#)<sup>[367]</sup>. Within a HyperTerminal session, the current settings are summarized across the base of the screen.
  - b. Arrange the program windows so that the Terminal program and IP Office Manager TFTP Log are visible at the same time.
  - c. Switch off power to the IP Office control unit.
  - d. Power on the control unit and press the escape key every second until you get a Loader message. Below is an example.

```
P12 Loader 2.4
CPU Revision 0x0900
```
  - e. Enter **AT** (note upper case). The control unit should respond **OK**.
  - f. If an OK response is not received, check the settings of your terminal program and repeat the process above.
3. Proceed with the erasure process.
  - To erase the alarm log enter **AT-X1**.
  - To erase the current configuration, enter **AT-X2**. A typical response is **Sector 2 Erase (NV Config)** followed by **OK**. Enter **AT-X3**. A typical response is **Sector Erases (Config)** followed by a series of **OK** responses.
4. Switch power to the control unit off and then back on. Within the terminal program you should see various messages as the control unit performs various start up tasks.
5. Close the terminal program session.
6. IP Office Manager can now be used to alter and then upload an old configuration file or receive and edit the control unit's now defaulted configuration.

## 11.7 Defaulting Security Settings

If necessary, the security settings for access to the system can be defaulted. This includes resetting all the security service user accounts including those that are used by IP Office applications. Therefore, those application may need to be reconfigured to use the new service user accounts or account passwords.

Defaulting the system security settings does not affect user passwords, voicemail codes and login codes. However, the security settings includes rules for acceptable user passwords. Therefore, following a security default existing user passwords may be flagged as being in error.

Following the security default, the advice in the [Securing the System](#) <sup>[114]</sup> chapter should be followed. For details of the default security settings for a system refer to the IP Office Manager documentation.

- **! Warning - Service Disruption**

Whilst defaulting the security settings does not require a system reboot, it may cause service disruption for several minutes while the system generates a new default security certificate.

### Process Options

1. [Defaulting the security settings using IP Office Manager](#) <sup>[158]</sup>
2. [Defaulting the security settings using IP Office Web Manager](#) <sup>[158]</sup>
3. [Defaulting the security settings using the RS232 port](#) <sup>[159]</sup>
4. [Defaulting the security settings using the Boot Loader](#) <sup>[160]</sup>

### Logging in after defaulting the security settings:

When IP Office Manager connects to a system with default security settings, you are prompted to change the default passwords. This also applies if any one of the passwords is returned to the default value.

The screenshot shows a dialog box titled "Change Password - 000C2923ECCE - Administrator (Primary System - IPO-Linux-PC)". It contains three sections for password changes:

- Administrator:** Minimum Password Length: 8. The password must include at least TWO of the following: Uppercase, Lowercase, Numbers, Special Character [# , \*, etc]. Three or more repeated characters are not allowed. The password cannot be 'Administrator', 'securitypwd', or 'password'. Fields for New Password and Re-Enter New Password.
- Security Administrator:** Minimum Password Length: 8. The password must include at least TWO of the following: Uppercase, Lowercase, Numbers, Special Character [# , \*, etc]. Three or more repeated characters are not allowed. The password cannot be 'Administrator', 'securitypwd', or 'password'. Fields for New Password and Re-Enter New Password.
- System Password:** Minimum Password Length: 1. The password cannot be 'Administrator', 'securitypwd', or 'password'. The password cannot be same as the Administrator or Security Administrator password being set. Fields for New Password and Re-Enter New Password.

Buttons for OK and Cancel are at the bottom.

---

## 11.7.1 Defaulting Security Using IP Office Manager

Read and note the warnings regarding [defaulting the security settings](#)<sup>[157]</sup> before using this process.

- **! Warning - Service Disruption**

Whilst defaulting the security settings does not require a system reboot, it may cause service disruption for several minutes while the system generates a new default security certificate.

### To default a system's security settings using IP Office Manager

1. Start IP Office Manager.
2. Select **File | Advanced | Erase Security Settings (Default)**.
3. Select the system from the menu and click **OK**.
4. Enter a name and password for security configuration access.
5. IP Office Manager indicates when the security settings have been reset.

## 11.7.2 Defaulting Security Using IP Office Web Manager

Read and note the warnings regarding [defaulting the security settings](#)<sup>[157]</sup> before using this process.

- **! Warning - Service Disruption**

Whilst defaulting the security settings does not require a system reboot, it may cause service disruption for several minutes while the system generates a new default security certificate.

### To default a system's security settings using IP Office Web Manager

1. Login to IP Office Web Manager.
  - a. Enter the system's IP address in the browser. Select **IP Office Web Manager**. Alternatively, enter `https://<IP_Address>:8443/WebMgmtEE/WebManagement.html`.
  - b. Enter an administrator user name and password and click **Login**.
2. Click **Actions**. Select **Service Commands** and then **Erase Security Settings**.
3. Click **OK**.

### 11.7.3 Defaulting Security using the RS232 Port

Read and note the warnings regarding [defaulting the security settings](#)<sup>[157]</sup> before using this process.

- **! Warning - Service Disruption**

Whilst defaulting the security settings does not require a system reboot, it may cause service disruption for several minutes while the system generates a new default security certificate.

-  **WARNING**

Use of the RS232 port should only be performed if absolutely necessary and only if the actions cannot be completed using IP Office Manager or IP Office Web Manager. In all cases, you must make every effort to ensure that you have a backup copy of the system configuration.

#### To default a system' security settings via DTE

This process defaults the IP Office's security settings but does not alter its configuration settings.

1. Attach the serial cable between the PC and the DTE port on the IP Office control unit.
2. Start the terminal program on your PC. Ensure that it has been setup as listed in [DTE Port Settings](#)<sup>[367]</sup>. Within a HyperTerminal session, the current settings are summarized across the base of the screen.
3. Enter **AT** (note upper case). The control unit should respond **OK**.
4. Enter **AT-SECURITYRESETALL**.
5. You will be prompted to confirm the control unit's MAC address before continuing. Enter the address.
6. After approximately a minute, the control unit will respond **OK** when the action has been completed.
7. Close the terminal program session.
8. IP Office Manager can now be used to receive and edit the control unit's now defaulted security settings.

---

## 11.7.4 Defaulting Security Using the Boot Loader

Read and note the warnings regarding [defaulting the security settings](#)<sup>[157]</sup> before using this process.

- **! Warning - Service Disruption**

Whilst defaulting the security settings does not require a system reboot, it may cause service disruption for several minutes while the system generates a new default security certificate.

- **⚠ WARNING**

Use of the RS232 port should only be performed if absolutely necessary and only if the actions cannot be completed using IP Office Manager or IP Office Web Manager. In all cases, you must make every effort to ensure that you have a backup copy of the system configuration.

### To default a system's security settings via Boot Loader

This process defaults the IP Office security settings and its configurations settings.

1. Ensure that you have a backup copy of the IP Office's configuration before performing this action. If a copy of the configuration cannot be downloaded using IP Office Manager, check the IP Office Manager application directory for previously downloaded configurations.
  - a. Use IP Office Manager to download an up to date copy of the configuration. If that is not possible, check in the IP Office Manager application folder for a previous copy of the configuration.
  - b. Using IP Office Manager, select **File | Open Configuration**.
  - c. Using the **Select IP Office Menu**, locate and select the IP Office system. Click **OK**.
  - d. Enter the name and password for a service user account on that IP Office. Click **OK**. IP Office Manager will receive and display the configuration from the IP Office.
    - If not already done, this action creates a BOOTP entry in IP Office Manager for the IP Office system.
    - This action also confirms communication between the IP Office Manager PC and the IP Office prior to any following process.
  - e. Select **File | Save Configuration As...** and save a copy of the configuration file onto the PC.
2. Attach the serial cable between the PC and the RS232 DTE port on the IP Office control unit.
  - a. Start the terminal program on your PC. Ensure that it has been setup as listed in [RS232 DTE Port Settings](#)<sup>[367]</sup>. Within a HyperTerminal session, the current settings are summarized across the base of the screen.
  - b. Arrange the program windows so that the Terminal program and IP Office Manager TFTP Log are visible at the same time.
  - c. Switch off power to the IP Office control unit.
  - d. Power on the control unit and press the escape key every second until you get a Loader message. Below is an example.

```
P12 Loader 2.4
CPU Revision 0x0900
```
  - e. Enter **AT** (note upper case). The control unit should respond **OK**.
  - f. If an OK response is not received, check the settings of your terminal program and repeat the process above.
3. To erase the current configuration in RAM memory enter **AT-X3**. A typical response is **Sector Erases (Config)** followed by a series of **OK** responses.
4. To erase the backup configuration stored in non-volatile memory enter **AT-X2**. A typical response is **Sector 2 Erase (NV Config)** followed by **OK**. IP Office 403 only: If running an IP Office 403 control unit, also enter **AT-X4**.
5. Switch power to the control unit off and then back on. Within the terminal program you should see various messages as the control unit performs various start up tasks.
6. Close the terminal program session.
7. IP Office Manager can now be used to alter and then upload an old configuration file or receive and edit the control unit's now defaulted configuration.



## 11.8 Loading a Configuration

The existing configuration of a system can be replaced with a new configuration that has been prepared separately.

- The configuration created must match the physical equipment in the IP Office system onto which the configuration will be loaded. Doing otherwise may cause the IP Office system to reset and experience other problems.

### Process Options

1. [Creating an offline configuration file](#) <sup>[162]</sup>
2. [Loading a configuration file using IP Office Manager](#) <sup>[163]</sup>
3. [Loading a configuration file using IP Office Web Manager](#) <sup>[163]</sup>
4. [Loading a configuration file onto a System SD card](#) <sup>[163]</sup>

## 11.8.1 Creating an Offline Configuration File

IP Office Manager can be used to create a new configuration without connecting to an IP Office system. During the process, you can specify the locale of the system, what type of trunk cards it uses and what type of control unit and expansion modules to include.

This allows the creation of a configuration prior to installation of system. The configuration file can be placed onto the System SD card before it is installed into the system. Otherwise the configuration can be uploaded to the system after initial installation of the system.

- The configuration created must match the physical equipment in the IP Office system onto which the configuration will be loaded. Doing otherwise may cause the IP Office system to reset and experience other problems.

### To create an offline configuration file

1. Start IP Office Manager with no configuration loaded into IP Office Manager
2. Select **File | Create an Offline Configuration** .

Slot	Extension/VCM	Trunk
1	None	None
2	None	None
3	None	None
4	None	None

3. Select the type of configuration that you want to create. The equipment and settings are restricted to those supported in the selected mode.
4. When completed click **OK**.
5. IP Office Manager creates and loads the configuration.
6. Edit the configuration to match the customer requirements. This can include importing information from preprepared CSV files.
7. When completed, select **File | Save Configuration As**.
8. When prompted to enter a password to encrypt the file, leave the fields blank and click **OK**.

Enter a password to encrypt the file or leave empty to save unencrypted.

Enter Password (Minimum 8 characters)

Re-enter password (For confirmation)

OK Cancel Help

## 11.8.2 Loading a Configuration Using IP Office Manager

This process will replace the existing configuration.

- The configuration created must match the physical equipment in the IP Office system onto which the configuration will be loaded. Doing otherwise may cause the IP Office system to reset and experience other problems.

### To load an offline configuration using IP Office Manager

1. Start IP Office Manager.
2. Select **File | Offline | Open File...**
3. Select the configuration file and click **Open**.
4. Check that the configuration settings are as expected and make any adjustments necessary.
5. Select **File | Offline | Send Config...**
6. Select the system and click **OK**.
7. Enter an administrator name and password and click **OK**.
8. Select when the new configuration should be loaded. Do not select the **Merge** option.
9. Click **OK**.

## 11.8.3 Loading a Configuration Using IP Office Web Manager

This process will replace the existing configuration.

- The configuration created must match the physical equipment in the IP Office system onto which the configuration will be loaded. Doing otherwise may cause the IP Office system to reset and experience other problems.

### To load an offline configuration using IP Office Web Manager

1. Login to IP Office Web Manager.
  - a. Enter the system's IP address in the browser. Select **IP Office Web Manager**. Alternatively, enter `https://<IP_Address>:8443/WebMgmtEE/WebManagement.html`.
  - b. Enter an administrator user name and password and click **Login**.
2. Click **Actions**. Select **Service Commands** and then **Upload Configuration**. Click **Monitoring** and select **Upload Configuration**.
3. Click **Browse** and select the configuration file.
4. Click **Upload**.
5. Click **OK**.
6. Reboot the system for the new configuration to be applied fully. See [Rebooting a System](#) <sup>[140]</sup>.

## 11.8.4 Loading a Configuration onto a System SD Card

This process will replace the existing configuration.

- The configuration created must match the physical equipment in the IP Office system onto which the configuration will be loaded. Doing otherwise may cause the IP Office system to reset and experience other problems.

### To load a configuration directly onto a System SD card

1. Rename the offline configuration file as `config.cfg`.
2. Shutdown and remove the System SD card. See [Memory Card Shutdown/Removal](#) <sup>[140]</sup>.
3. Insert the SD card into the PC and display the card contents.
4. Open the `/system/primary` folder and replace the existing `config.cfg` file with the new file.
5. Reinsert the System SD card into the system.
6. Reboot the system. See [Rebooting a System](#) <sup>[140]</sup>.

---

## 11.9 Upgrading systems

There are several methods by which the system can be upgraded to a new release of IP Office core software.

- **! WARNING: Upgrading existing systems to IP Office Release 9.1:**  
Existing systems running a release lower than 8.1(65) must first upgrade to IP Office Release 8.1(65) (or higher 8.1) or any IP Office Release 9.0 before being upgraded to IP Office Release 9.1. The upgrade licenses for IP Office Release 9.1 are also valid for the lower releases, ie. intermediate upgrade license are not required.
- **! Warning: Upgrade License Requirements**  
On a new system, when the first call is made, the software level being run is written into the control unit's permanent memory. Any subsequent upgrade to a higher release may require a software upgrade licence. Systems upgraded without the appropriate upgrade license display "No license available" on some phones and will not allow any telephony functions.
- **! Note: Server Edition Systems**  
IP500 V2 control units configured as IP500 V2 Expansion System systems are upgraded through the Server Edition web management menus. Refer to the Server Edition documentation.



### WARNINGS

- **Check IP Office Technical Bulletins**  
Check the latest IP Office Technical Bulletin for the IP Office software release before proceeding any further. It may contain information relating to changes that occurred after this document was completed. Bulletins are available from <http://support.avaya.com>.
  - **! IP Office Web Manager**  
The addition of IP Office Web Manager requires changes to the security settings of systems. For new systems those changes are made automatically. However, for system being upgraded, the changes can only be made if the system's security settings are defaulted. See [Enabling IP Office Web Manager](#)<sup>[168]</sup> for additional steps that should be performed before upgrading to IP Office Release 8.0 or higher.
- **Other IP Office Applications**  
Upgrading the core software of the IP Office control unit will require upgrades to associated software. The levels of application software supported with the IP Office core are detailed in the IP Office Technical bulletin for the release.

### Process Options

1. **[Upgrading using the IP Office Manager Upgrade Wizard](#)**<sup>[165]</sup>  
This process upgrades the system or systems using the firmware files installed with the IP Office Manager application.
2. **[Remote Upgrade the System SD Card Files using IP Office Manager](#)**<sup>[167]</sup>  
This process upgrades the files on the System SD card remotely using IP Office Manager. The system then needs to be rebooted to use the new files.
3. **[Upgrading a System SD Card using the IP Office Manager PC](#)**<sup>[167]</sup>  
A PC running IP Office Manager can be used to directly update the files on an SD card. That card can then be inserted into the system and the system restarted.
4. **[Upgrading using an optional SD card](#)**<sup>[168]</sup>  
This process upgrades the system by using IP Office Manager to create an SD card loaded with the files installed with the IP Office Manager application.
5. **[Upgrading using IP Office Web Manager](#)**<sup>[169]</sup>  
This process upgrades the system using a set of firmware files provided for the purpose. It does not require IP Office Manager.

## 11.9.1 Upgrade Using the Upgrade Wizard

The Upgrade Wizard is part of IP Office Manager. It can be used to upgrade multiple system's at the same time.

- **! Warning: IP Office Manager Version**

This process uses software files provided by the installed version of IP Office Manager being used. You must ensure that the version of IP Office Manager used matches the version of software required.

- **Multiple Managers**

If more than one copy of IP Office Manager is running, it is possible for the IP Office to request BIN files from a different IP Office Manager than the one that started the upgrade process. Ensure that only one copy of IP Office Manager is running when upgrading an IP Office system.

- **! WARNING: Upgrading existing systems to IP Office Release 9.1:**

Existing systems running a release lower than 8.1(65) must first upgrade to IP Office Release 8.1(65) (or higher 8.1) or any IP Office Release 9.0 before being upgraded to IP Office Release 9.1. The upgrade licenses for IP Office Release 9.1 are also valid for the lower releases, ie. intermediate upgrade license are not required.

### To upgrade systems using the upgrade wizard

1. Ensure that you have a backup copy of the IP Office's configuration before performing this action. If a copy of the configuration cannot be downloaded using IP Office Manager, check the IP Office Manager application directory for previously downloaded configurations.
  - a. Use IP Office Manager to download an up to date copy of the configuration. If that is not possible, check in the IP Office Manager application folder for a previous copy of the configuration.
  - b. Using IP Office Manager, select **File | Open Configuration**.
  - c. Using the **Select IP Office Menu**, locate and select the IP Office system. Click **OK**.
  - d. Enter the name and password for a service user account on that IP Office. Click **OK**. IP Office Manager will receive and display the configuration from the IP Office.
    - If not already done, this action creates a BOOTP entry in IP Office Manager for the IP Office system.
    - This action also confirms communication between the IP Office Manager PC and the IP Office prior to any following process.
  - e. Select **File | Save Configuration As...** and save a copy of the configuration file onto the PC.
2. Select **File | Advanced | Upgrade**. The UpgradeWiz is started and scans for IP Office modules using the **Unit/Broadcast** address. Adjust this address and click **Refresh** if the expected control units are not shown. The current version of each IP Office BIN file held in the control units memory is shown. That is regardless of whether that .bin file is currently being used by any module in the system.
3. The **Version** column indicates the current version of software installed. The **Available** column indicates the version of software IP Office Manager has available. If the available version is higher, the check box next to that row is automatically selected.
  - If any of the modules have pre-version 2.1 software installed, an upgrade with **Validate** unticked is required. If this is the case, only continue with the upgrade process using a PC with a fixed IP address on the same LAN domain and physical LAN segment as the IP Office control unit and only upgrade the pre-2.1 system.
  - If a multi-stage upgrade is necessary, use the following additional steps to select the appropriate interim software:
    - Right-click on the upgrade wizard and click **Select Directory**. Locate and select the directory containing the bin file for the intermediate software level.
    - The upgrade wizard should now list just the control unit as having upgrade software available.
  - Upgrading to particular levels of IP Office software require a **Software Upgrade X** license where X is a number. The **Licensed** and **Required License** columns indicate the current highest upgrade license the system has and the required software upgrade license for the currently installed software.
    - It does not indicate the license requirement for the level of software in the **Available** column.
    - A value of 255 indicates that the control unit is still in its initial upgrade entitlement period. See [Upgrade Licenses](#) <sup>(376)</sup>.
    - The maximum level of software supported by the **Licensed** and **Required License** values is indicated in brackets.
4. For those modules which you want to upgrade, tick the check box. The following additional options are available:
  - **Backup System Files**  
If selected, before upgrading to the new software, the current files in the System SD cards **/primary** folder will be copied to its **/backup** folder.

---

- **Upload System Files**

If selected, the full set of software files that IP Office Manager has is copied to the **/primary** folder on the System SD card. In addition to control unit and module software this includes phone software files. Following the reboot, the phones upgrade using those files if necessary.

- **Restart IP Phones**

If selected, following the upgrade and reboot, all Avaya IP phones are also restarted. This will cause them to recheck whether the firmware they currently have loaded matches that on their configured file server. Use this option if the IP Office system is the file server and the upgrade included new IP phone firmware.

6. Select **Upgrade**. The system password for each system will be requested. Enter it and click **OK**. The next steps depend on the upgrade options selected. Do not cancel or close the upgrade wizard while these processes are running.

- **Validated Upgrade**

If using the **Validated** option, a number of actions take place as follows;

a. The upgrade wizard checks the amount of free RAM memory available in the control unit to temporarily store the new BIN files. If insufficient memory is available, you will be prompted whether to continue with an off-line upgrade or cancel upgrading.

- If offline is selected, the IP Office is rebooted into offline mode. It may be necessary to use the **Refresh** option within the Upgrade Wizard to reconnect following the reboot. Validate upgrade can then be attempted to again check the amount of available RAM memory for transfer of BIN files. If the memory is still insufficient, the option is offered to either do an unvalidated upgrade or cancel.

b. The bin files required are transferred to the system and stored in temporary memory.

c. The backup system files and upload system files actions are performed if they were selected.

d. Once all file transfers are completed, the upgrade wizard will prompt whether it okay to proceed with the upgrade process. Select **Yes** to continue. The control unit reboots and upgrades itself first. It then proceeds with upgrading the external expansion modules.

- **Unvalidated Upgrade**

This method of upgrading should be avoided unless absolutely necessary. It is only required for IP Office systems with pre-2.1 software and should only be done from a IP Office Manager PC with a fixed IP address running on the same LAN segment and subnet as the IP Office system. During the upgrade, the units and modules erases their current software and then request the new software file from IP Office Manager.

7. Following the upgrade check that the upgrade wizard now shows that the selected units and modules have upgraded. It may be necessary to select **Refresh** to update the information in the upgrade wizard display.

8. Repeat the process as required.

## 11.9.2 Remote Upgrade the System SD Card Using Manager

This process will copy all system files not present on the System SD card and those files which have a different version to those already present on the card. That includes IP Office software files and Embedded Voicemail prompt files.

- **! Warning: IP Office Manager Version**

This process uses software files provided by the installed version of IP Office Manager being used. You must ensure that the version of IP Office Manager used matches the version of software required.

- **! WARNING: Upgrading existing systems to IP Office Release 9.1:**

Existing systems running a release lower than 8.1(65) must first upgrade to IP Office Release 8.1(65) (or higher 8.1) or any IP Office Release 9.0 before being upgraded to IP Office Release 9.1. The upgrade licenses for IP Office Release 9.1 are also valid for the lower releases, ie. intermediate upgrade license are not required.

### To upgrade a system using the embedded file manager

1. Using IP Office Manager, select **File | Embedded File Management**.
2. Using the **Select IP Office** menu, select the IP Office system.
3. The file contents of the memory cards are displayed.
4. Select **File | Backup System Files**. The contents of the **/primary** folder on the System SD card will be copied to the **/backup** folder. This process takes approximately 6 minutes.
5. Select **File | Upload System Files**. The system files that IP Office Manager has will be uploaded to the **/primary** folder on the System SD card. This includes IP Office software files and Embedded Voicemail prompt files. Depending on the files that need to be updated, this process can take up to 40 minutes.

## 11.9.3 Upgrading the SD Card Locally

The following process can be used if you have physical access to the IP500 V2 control unit. This method be used with a timed reboot, allowing the card upgrade to be done during normal operation hours followed by a reboot outside of normal operation hours.

If the card is being used for Embedded Voicemail, that service is not available while the card is shutdown. Licensed features however will continue running for up to 2 hours while the card is shutdown.

- **! Warning: IP Office Manager Version**

This process uses software files provided by the installed version of IP Office Manager being used. You must ensure that the version of IP Office Manager used matches the version of software required.

- **! WARNING: Upgrading existing systems to IP Office Release 9.1:**

Existing systems running a release lower than 8.1(65) must first upgrade to IP Office Release 8.1(65) (or higher 8.1) or any IP Office Release 9.0 before being upgraded to IP Office Release 9.1. The upgrade licenses for IP Office Release 9.1 are also valid for the lower releases, ie. intermediate upgrade license are not required.

### To upgrade a System SD Card using a PC

1. [Shutdown the System SD memory card](#)<sup>[146]</sup> and remove it from the control unit.
2. Follow the process for [recreating the SD card](#)<sup>[126]</sup>. This process will overwrite the software files on the card with the files available to IP Office Manager. It will not affect any other files, for example the configuration file and Embedded Voicemail messages. This process takes approximately 15 minutes.
3. When the recreate process has completed, reinsert the card into the control unit's **System SD** card slot.
4. Using IP Office Manager select **File | Advanced | Reboot**.
5. In the **Select IP Office** menu, select the IP500 V2 system and click **OK**.
6. Select the type of reboot that you want performed and click **OK**.
7. When the system is rebooted, as it restarts it will load the software files in the primary folder of the System SD card.

---

## 11.9.4 Upgrading an SD Card in a PC

The PC running IP Office Manager can be used to load the full set of operation files onto an SD card. This includes the firmware for the core system, phone firmware files and files for embedded voicemail. If the card contains configuration, message and prompt files, those files are not deleted by this process.

- **! Warning: IP Office Manager Version**

This process uses software files provided by the installed version of IP Office Manager being used. You must ensure that the version of IP Office Manager used matches the version of software required.

- **! WARNING: Upgrading existing systems to IP Office Release 9.1:**

Existing systems running a release lower than 8.1(65) must first upgrade to IP Office Release 8.1(65) (or higher 8.1) or any IP Office Release 9.0 before being upgraded to IP Office Release 9.1. The upgrade licenses for IP Office Release 9.1 are also valid for the lower releases, ie. intermediate upgrade license are not required.

### Upgrade by Updating the System SD Card

1. Shutdown the System SD card and remove the card from the system. See [Memory Card Shutdown/Removal](#)<sup>[140]</sup>.
2. Insert the card into the PC and use the IP Office Manager process below to upgrade the files on the card.
3. Reinsert the card into the System SD card slot on the system.
4. Reboot the system. See [Rebooting a System](#)<sup>[140]</sup>.

### Upgrade by Updating an Optional SD Card

1. Shutdown the Optional SD card and remove the card from the system. See [Memory Card Shutdown/Removal](#)<sup>[140]</sup>.
2. Insert the card into the PC and use the IP Office Manager process below to upgrade the files on the card.
3. Reinsert the card into the Optional SD card slot on the system.
4. Copy the files from the Optional SD card to the System SD card. See [Loading Software from an Optional SD Card](#)<sup>[136]</sup>.
5. Reboot the system. See [Rebooting a System](#)<sup>[140]</sup>.

### To upgrade a SD card using the IP Office Manager PC

1. Once started do not interrupt this process, for example by removing the SD card. This process takes approximately 15 minutes.
2. Insert the SD card into a card reader on the IP Office Manager PC.
3. Using IP Office Manager, select **File | Advanced | Recreate IP Office SD Card**.
4. Select **IP Office A-Law**, **IP Office U-Law**, **IP Office Partner Edition**. or **IP Office Norstar Edition**. This selection will affect how the IP Office systems operates when defaulted with this card present in its **System SD** card slot.
5. Browse to the card location and click **OK**.
6. IP Office Manager will prompt whether you want to include Avaya IP Office Web Manager files as part of the recreate process. Those files are necessary if you want to run IP Office Web Manager to manage the IP Office system into which the card will be loaded or if you want to use [on-boarding](#)<sup>[118]</sup>.
7. IP Office Manager will start creating folders on the SD card and copying the required files into those folders. This process will take approximately 15 minutes.
8. Do not remove the SD card during the process. Wait until the IP Office Manager displays a message.





## 11.9.5 Upgrading Using IP Office Web Manager

Avaya may make upgrade packages available for use with IP Office Web Manager. Once unpacked onto a local PC, the process below can be used to upgrade the system.

- **! WARNING: Upgrading existing systems to IP Office Release 9.1:**

Existing systems running a release lower than 8.1(65) must first upgrade to IP Office Release 8.1(65) (or higher 8.1) or any IP Office Release 9.0 before being upgraded to IP Office Release 9.1. The upgrade licenses for IP Office Release 9.1 are also valid for the lower releases, ie. intermediate upgrade license are not required.

### To upgrade a system using IP Office Web Manager

1. Login to IP Office Web Manager.
  - a. Enter the system's IP address in the browser. Select **IP Office Web Manager**. Alternatively, enter *https://<IP\_Address>:8443/WebMgmtEE/WebManagement.html*.
  - b. Enter an administrator user name and password and click **Login**.
2. Unpack the upgrade files to a location on your client PC.
3. Click **Actions** and select **Upgrade**.
4. Click **Configure Path**.
5. Select the folder containing the unpacked upgrade files and click **Open**.
6. Click **Start Upgrade**.



## 11.10 Swapping Extension Users

Whilst the example below shows 2 users swapping extensions the method can be used to swap multiple users within the configuration and effecting the swaps after a single merge of the configuration changes.

### Swapping Extension Users

For this example User A (202) and User B (203) want to swap extensions.

1. Load the IP Office configuration and select  **Extension**.
2. Locate the extension with the **Base Extension** set to **202**, ie. matching User A's extension number.
  - If the group pane is visible (**View | Group Pane**) in IP Office Manager, it shows the extension details (ID, Module, Port and Base Extension).

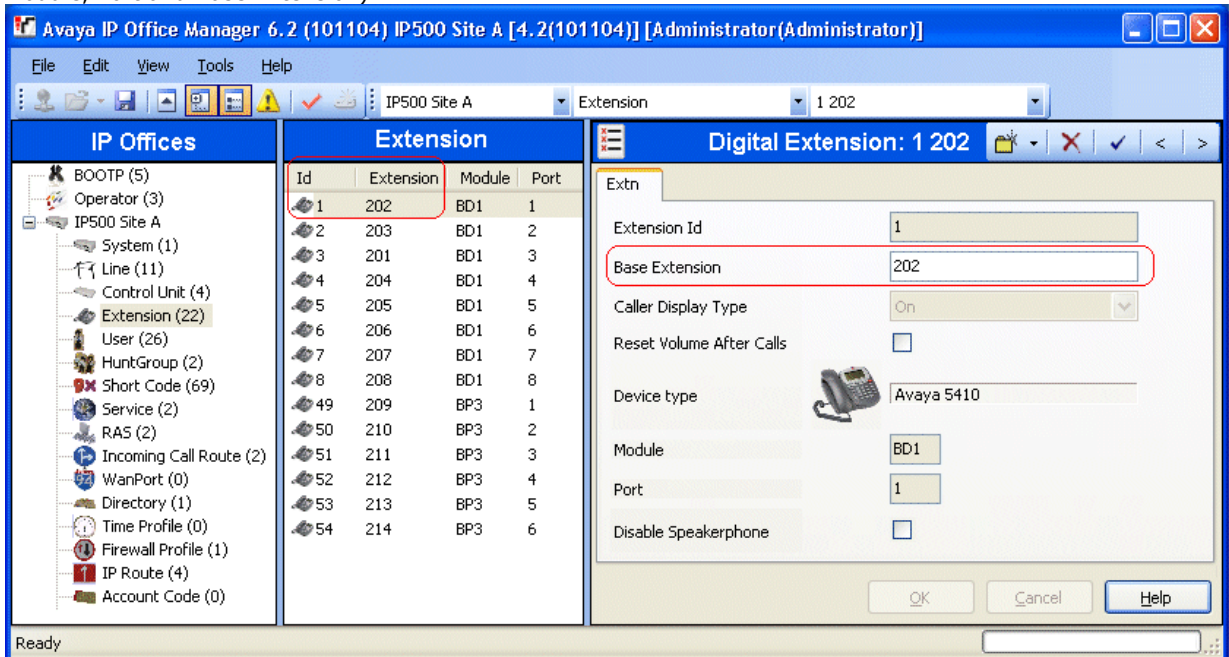

3. Select that extension and change its **Base Extension** setting to **203**, ie. to now match User B's extension number. If IP Office Manager is set to validate edits, it will warn that this change conflicts with the existing Base Extension setting of another extension. Ignore the warning at this stage. Click **OK**.
4. Locate the other extension with the **Base Extension** set to **203**, ie. matching User B's extension number.
5. Select that extension and change its **Base Extension** setting to **202**, ie. to now match User A's extension number. If the error pane is visible (**View | Error Pane**), the warnings about extension conflicts should now disappear. Click **OK**.
6. Save the configuration back to the IP Office system.
7. At each of the extensions dial the log out short code set on the IP Office system. By default this is **\*36**.
  - If any of the users is set to **Forced Login**, they will have to complete the login process at their new extension using their Login Code.

## 11.11 Out of Building Telephone Installations

The following are the only supported scenarios in which wired extensions and devices outside the main building can be connected to the IP Office system. In these scenarios, additional protection, in the form of protective grounding and surge protectors, must be fitted.

- ⚠ WARNING**

The fitting of additional protection does not remove the risk of damage. It merely reduces the chances of damage.

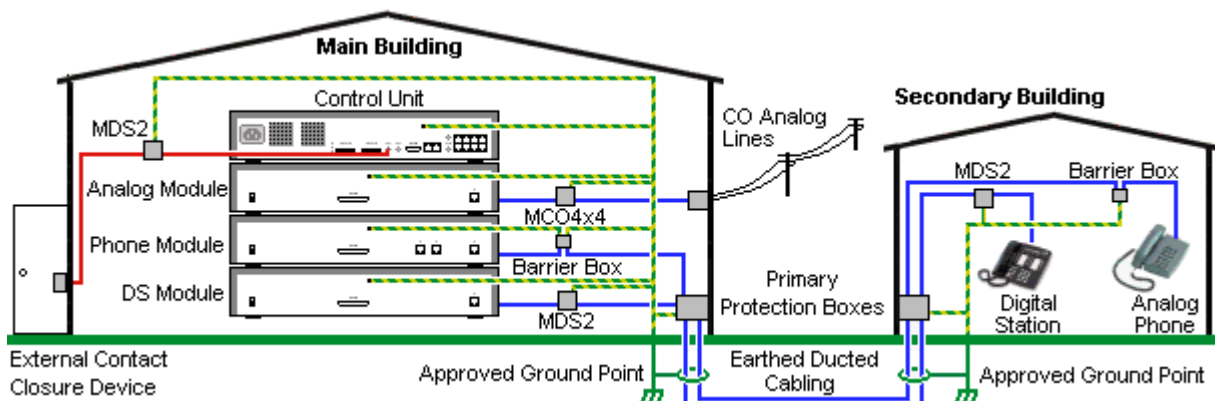

- Cables of different types, for example trunk lines, phone extensions, ground and power connections, should be kept separate.
- All cabling between buildings should be enclosed in grounded ducting. Ideally this ducting should be buried.
- A Primary Protection Box must be provided at the point where the cables enter the building. This should be three point protection (tip, ring and ground). Typically this would be gas tube protection provided by the local telephone company. The ground wire must be thick enough to handle all the lines being affected by indirect strike at the same time.

Connection Type	Protection Device Type	Requirement
<b>Analog Phone Extensions</b> Phones External expansion module ( <a href="#">POT</a> <sup>[365]</sup> or <a href="#">PHONE</a> <sup>[365]</sup> ) ports only.	<a href="#">IP Office Barrier Box</a> <sup>[174]</sup> Supports a single connection. Maximum of 16 on any expansion module.	<ul style="list-style-type: none"> <li>• Connection from the expansion module to the phone must be via a surge protector at each end and via the primary protection point in each building.</li> <li>• The IP Office external expansion modules, control unit and IROB devices must be connected to the protective ground point in their building.</li> </ul>
<b>DS Phone Extensions</b>	<a href="#">ITW Linx MDS2</a> <sup>[173]</sup> Supports up to 4 connections. This device was previously referred to as the Avaya 146E.	<ul style="list-style-type: none"> <li>• The between building connection must be via earthed ducting, preferable underground. The cable must not be exposed externally at any point.</li> </ul>
<b>BST Phone Extensions</b>	None	Currently not supported.
<b>Analog Trunks</b>	<a href="#">ITW Linx MCO4x4</a> <sup>[173]</sup> Supports up to 4 two-wire lines. This device was previously referred to as the Avaya 146C.	<p>For installations in the Republic of South Africa, the fitting of surge protection on analog trunks is a requirement.</p> <p>For other locations where the risk of lightning strikes is felt to be high, additional protection of incoming analog trunks is recommended.</p>
<b>External Output Switch</b>	<a href="#">ITW Linx MDS2</a> <sup>[173]</sup> Supports up to 4 connections. This device was previously referred to as the Avaya 146E.	<p>Connections from an IP Office Ext O/P port to an external relay device must be via a surge protector.</p> <p>When using the MDS2 on the Ext O/P port, use only the Line 1 and Equipment 1 jacks, do not use the Line 2 or Equipment 2 jacks.</p>

### 11.11.1 DS Phones

When digital phone extensions are required in another building, additional In-Range Out-Of-Building (IROB) protective equipment must be used. For phones connected to IP Office DS (360) ports, the supported device supplied by ITWLinx is a towerMAX DS/2 module. This IROB device was previously badged by Avaya as the 146E IROB.



**! WARNING**

This device is not supported for BST port connections, ie. 4100 Series, T-Series, 7400 Series and M-Series phones.

The protection device should be installed as per the instructions supplied with the device. The ground points on the IP Office control unit and any external expansion modules must be connected to a protective ground using 18AWG wire with a green and yellow sleeve.

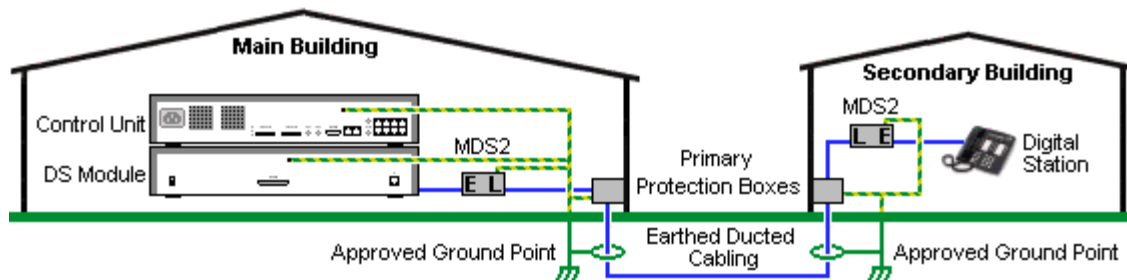
Typically the IROBs 2 RJ45 EQUIPMENT ports are straight through connected to the 2 RJ45 LINE ports. This allows existing RJ45 structured cabling, using pins 4 and 5, to be used without rewiring for up to two DS connection. However, each of these ports can be used to connect a second extension using pins 3 and 6.



LINE	Signal	EQUIPMENT
RJ45 	1 Not used.	1 RJ45 
2 Not used.	2	2
3 Ring II (Optional)	3	3
4 Ring I	4	4
5 Tip I	5	5
6 Tip II (Optional)	6	6
7 Not used.	7	7
8 Not used.	8	8

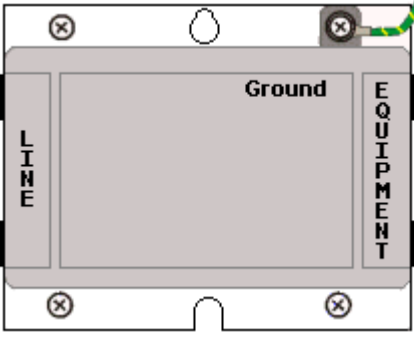

## 11.11.2 Analog Phone Barrier Box

Where analog phone extensions are required in another building, additional protective equipment must be used, in the form of IP Office Phone Barrier Boxes and protective earth connections.

- **⚠ CAUTION**  
PHONE (POT) ports on the front of control units must not be used for extensions that are external to the main building.
- The correct IP Office specific barrier boxes must be used. These modules have been designed specifically for the signalling voltages used by the IP Office system:
  - Only the IP Office Phone Barrier Box should be used with Phone V1 modules.
  - Only the IP Office Phone Barrier Box V2 should be used with Phone V2 modules.
  - No other type of analog phone barrier box should be used.
- Where more than 3 barrier boxes are required in a building, they must be rack mounted using a [Barrier Box rack mounting kit](#)<sup>[17]</sup>.
- A maximum of 16 barrier boxes can be used with any Phone module.
- The Phone Barrier Box does not connect the ringing capacitor in Phone V1 modules.

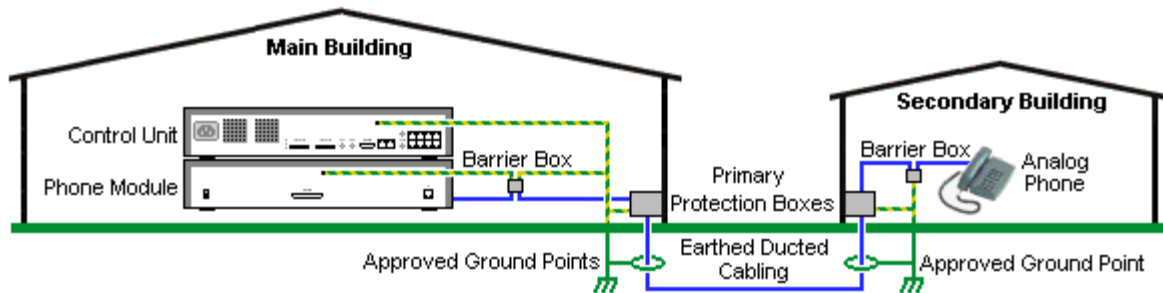

Main Building	Barrier Box	Secondary Building
<ul style="list-style-type: none"> <li>• <b>RJ11</b> Connect to PHONE (POT) port on the Phone module using cable supplied with the barrier box.</li> <li>• <b>RJ45</b> Connect to the secondary building barrier box via primary protection in both buildings.</li> </ul>		<ul style="list-style-type: none"> <li>• <b>RJ11</b> Connect to analog phone. Cable not supplied.</li> <li>• <b>RJ45</b> From main building via primary protection in both buildings.</li> </ul>
<ul style="list-style-type: none"> <li>• <b>Center Screw</b> Connect to main building protective ground (or ground terminal of Barrier Box Rack Mounting Kit). Use 18AWG (minimum) wire with a green and yellow sleeve.</li> <li>• <b>Right-Hand Screw</b> Connect to ground point on Phone module using ground cable supplied with barrier box.</li> </ul>		<ul style="list-style-type: none"> <li>• <b>Center Screw</b> Connect to main building protective ground. Use 18AWG (minimum) wire with a green and yellow sleeve.</li> <li>• <b>Right-Hand Screw</b> Not used.</li> </ul>

1. The following wires must be kept apart, that is not routed in the same bundle:

- Earth leads from the barrier box to the Phone modules.
- Internal wires, for example extension leads going directly to the Phone modules.
- Wires from external telephone going directly to the barrier boxes.

IP Office Barrier Boxes	SAP Code
<p><b>Phone Barrier Box (81V)</b> Use with Phone V1 module. Includes an RJ45 to RJ11 cable and a functional earth lead.</p>	700293897
<p><b>Phone Barrier Box V2 (101V)</b> Use with Phone V2 module. Includes an RJ45 to RJ11 cable and a functional earth lead.</p>	700385495
<p><b>Barrier Box Rack Mounting Kit</b></p>	700293905

### 11.11.3 Rack Mounting Barrier Boxes

Where more than 3 Phone Barrier Boxes are used they must be rack mounted. The Barrier Box Rack Mounting Kit (SAP Code 700293905) supports up to 8 Phone Barrier Boxes.

1. Unscrew the two screws arranged diagonally at the front of each barrier box and use these same screws to reattach the barrier box to the rack mounting strip.
2. Each barrier box is supplied with a solid green ground wire connected to its functional ground screw. Remove and discard this wire. Connect a green/yellow ground wire to the protective earth screw in the center of the Point on the back of the Barrier Box.

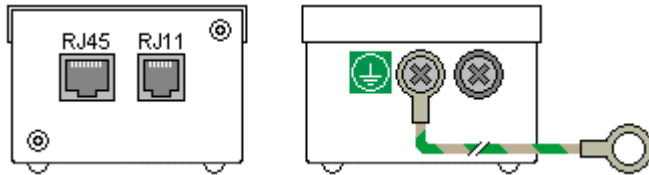

3. The rack mounting strip has threaded M4 earthing pillars. Connect the other end of the barrier box ground wire, using M4 washers and nuts, to the earthing pillar on that side of the rack mounting strip.

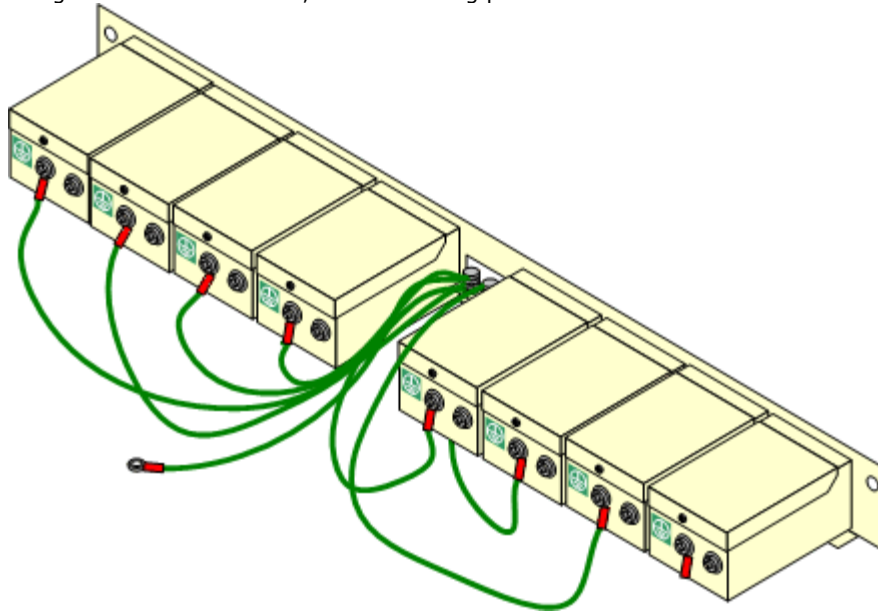

4. Using 14AWG wire with green and yellow sleeve, connect one of the earthing pillars to the buildings protective earth.
5. Using 14AWG wire with green and yellow sleeve, connect the other earthing pillar to the Phone module.
6. Ensure that the following wires are not routed together in the same bundle:
  - Earth lead from the barrier box to the Phone module.
  - Internal wires, e.g. wires going directly to the Phone module.
  - Wires from external telephone going directly to the barrier boxes.

## 11.12 Using the External Output Port

All the IP Office control units are equipped with a EXT O/P port. The port is marked as EXT O/P and is located on the back of the control unit adjacent to the power supply input socket.

The port can be used to control up to two external devices such as door entry relay switches. The usual application for these switches is to activate relays on door entry systems. However, as long as the criteria for maximum current, voltage and if necessary protection are met, the switches can be used for other applications.

The switches can be switched closed, open or pulsed (closed for 5 seconds and then open). This can be done in a number of ways:

- Using IP Office short codes.
- Through the **Door Release** option in IP Office SoftConsole.
- Via the **Open Door** action in Voicemail Pro.

### Default Short Codes

The following are the default short codes in the IP Office configuration for external output switch operation. They use the short code features Relay On (closed), Relay Off (open) and Relay Pulse.

State	Switch 1	Switch 2
<b>Closed</b>	*39	*42
<b>Open</b>	*40	*43
<b>Pulse</b>	*41	*44

### 11.12.1 Port Connection

These ports are found on the rear of all IP Office control units. They are used for connection to external switching relays. The port uses a standard 3.5mm stereo jack plug for connection.

The IP Office is able to open (high resistance), close (low resistance) or pulse (close for 5 seconds and then open) two switches within the port. Either switch can be operated separately. These switches are intended for activation of external relays in systems such as door opening systems.

- **CAUTION:**

In installations where this port is connected to a device external to the building, connection must be via a ITW Linx MDS2 Surge Protector and a protective ground connection must be provided on the IP Office control unit. When using the MDS2 on the Ext O/P port, use only the Line 1 and Equipment 1 jacks, do not use the Line 2 or Equipment 2 jacks.

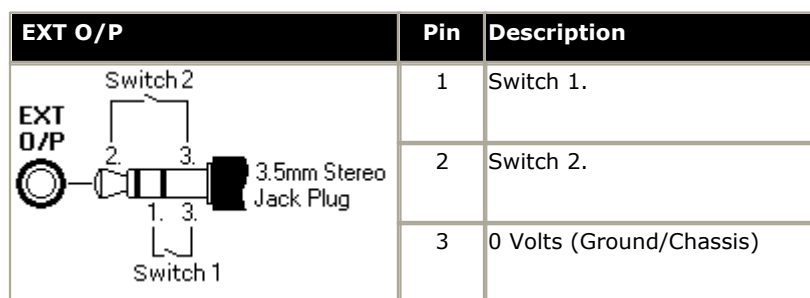

- Switching Capacity: 0.7A.
- Maximum Voltage: 55V d.c.
- On state resistance: 0.7 ohms.
- Short circuit current: 1A.
- Reverse circuit current capacity: 1.4A.
- Ensure that pins 1 and 2 are always at a positive voltage with respect to pin 3.

3.5mm stereo audio jack plugs are frequently sold as pre-wired sealed modules. It may be necessary to use a multi-meter to determine the wiring connections from an available plug. Typically 3 (common to both relays) is the cable screen.



## 11.13 So8 BRI Module

### 11.13.1 Example 1: ISDN Terminal

In this example, calls on DID 123456 are routed to the first port of the So8 expansion module. That port has been configured as Line Group ID 701.

#### 1. Configure an Incoming Call Routing

The destination is a short code that directs the call to the line group ID that contains the So lines. The **Bearer Capability** has been set to **Any**, to allow data and voice via this route.

- **Line Group ID:** 0
- **Incoming Number:** 123456
- **Destination:** 123456
- **Bearer Capability:** Any

#### 2. Create a System Short Code:

This is the destination used in the Incoming Call Route.

- **Short Code:** 123456
- **Telephone Number:** 123456
- **Line Group ID:** 701
- **Feature:** Dial

3. Send the configuration to the Control Unit.

Any call coming into the main system on DID 123456 will now be passed directly to the first port.

If you wish to assign DIDs from your main pool to individual ports and avoid network charges when dialing between them, try variations on the following:

1. You have DID ranges, for example: 7325551000 to 7325551099. You wish to assign 7325551000-19 to port 1 and 7325551020-20 to port 2 etc.

#### 2. Configure Incoming Call Route:

The # is used here instead of "n" to avoid problems with "Main". The minus sign means the number is processed from the left and so will wait for the whole number.

- Line Group ID: 701
- Incoming Number: -100x
- Destination: #

3. Repeat for Line Group ID 702 etc.

4. Create Short codes, for example:

- Short Code: 100x
- Telephone Number: .
- Line Group ID: 701
- Feature: Dial

S0 calls dialed without the area code are handled locally without network charges. Calls with area calls will go via the network.

---

## 11.13.2 Example 2: Video Conference

In this example, calls are routed to a Polycom Viewstation module connected to a S0 port of the IP Office system.

The following settings were used on 4 incoming data channels of a PRI line:

- Line Number: 5
- Channel Allocation: 23 -> 1
- Switch Type: 5ESS
- Line Sub Type: PRI
- Provider: AT&T
- Channels: 1-4
- Incoming Line Group: 95
- Outgoing Line Group: 95
- Direction: Bothway
- Bearer: Data
- Service: Accunet (this is a important)
- Admin: In Service

To route an incoming video call on the PRI lines configured above to an SO8 module requires the following:

1. Create a dial short code that has the SO port as its destination Line Group. For this example the following was used:

- Short Code: 1500
- Number: .
- Feature: Dial
- Line Group: 601 (the SO8 port number)

2. Create an Incoming Call Routing that routes the appropriate calls to that short code. For this example the following was used:

- Line Group: 95 (identifies calls using the PRI lines configured above)
- Destination: 1500 (the short code created above)
- Bearer: Any

To allow the video device on the S0 port to make outgoing calls to the PRI lines also requires a short code.

1. For this example the following was used:

- Code: 91N;
- Number: N
- Feature: Dial
- Line Group: 95

**Polycom Video Module Settings**

The Polycom modules used in the previous example were the Viewstation 128, Viewstation 256 and Viewstation MP.

The Polycom module must have software that supports 'Standard ETSI ISDN' (European ISDN) and have its ISDN Switch Protocol setting set to 'Standard ETSI Euro-ISDN'

The following were the settings used during testing:

<b>Characteristics</b>	<b>Admin/Software and Hardware/Software</b>
<ul style="list-style-type: none"> <li>• Polycom View Station 512 MP.</li> <li>• NTSC UIS Interface.</li> <li>• View Station PVS 1419.</li> </ul>	<ul style="list-style-type: none"> <li>• Software: 7.0.1.</li> <li>• Network Interface: S/T Interface.</li> <li>• ISDN Version: IEUS v18:a00320</li> </ul>
<b>Admin/General Setup</b>	<b>Admin/Video Network/ISDN Video Network</b>
<ul style="list-style-type: none"> <li>• Country: USA</li> <li>• Language: English (USA)</li> <li>• Auto Answer: Yes</li> <li>• AllowDial: Yes</li> <li>• Allow User Setup: Yes</li> <li>• Maximum Time on Call: 480.</li> </ul>	<ul style="list-style-type: none"> <li>• Country Code: 1</li> <li>• Area Code: 732</li> <li>• Number A: blank</li> <li>• Number B: blank</li> <li>• ISDN Switch Protocol: Standard ETSI Euro-ISDN.</li> </ul>
<b>User Setup</b>	<b>Admin/Video Network/IMUX</b>
<ul style="list-style-type: none"> <li>• Auto Answer: Yes</li> <li>• PIP: Auto</li> <li>• Far Control of Near Camera: Yes</li> <li>• MP Mode: Auto</li> </ul>	<ul style="list-style-type: none"> <li>• Numbers: blank</li> <li>• SPID: blank</li> <li>• Audio Quality: 168KB/s</li> <li>• Advanced Dialing: Dial Channels in Parallel</li> </ul>
<b>System Information</b>	<b>Admin/Software and Hardware/Hardware</b>
<ul style="list-style-type: none"> <li>• Release: 7.0.1</li> <li>• Model: VS: 512</li> </ul>	<ul style="list-style-type: none"> <li>• Camera: NTSC</li> <li>• Video Comm Interface: ISDN_Quad_BRI</li> <li>• Network Interface Type: S/T Interface</li> </ul>
<b>Admin/Video Network</b>	<b>Admin/Video Network/Call Preference</b>
<ul style="list-style-type: none"> <li>• MultiPoint Setup: Auto</li> </ul>	<ul style="list-style-type: none"> <li>• ISDN Video Calls (H:320): Yes</li> </ul>

---

## 11.14 SNMP

SNMP (Simple Network Management Protocol) is a standard network protocol that allows the monitoring and management of data devices across a network. An SNMP agent can be built into network devices such as routers and hubs. An SNMP manager application, for example CastleRock or HP OpenView, can then communicate with those devices.

IP Office 2.0 and above supports SNMP communication. This communication can be:

- **Polling:**

Some SNMP applications (called "managers") send out polling messages to the network. They then record the responds of any SNMP enabled devices (called "agents"). This allows the application to create a network map and to raise an alarm when devices previously present do not respond.

- Most SNMP manager applications can also do simple IP address polling to locate non-SNMP enabled devices. However this method of polling does not identify the device type or other information.
- SNMP polling including details about the responding device. For example an IP Office control unit's response includes the control unit type, level of software, routing table information, up time, etc.

- **Traps:**

When certain events occur, a devices SNMP agent can send details of the event to the SNMP manager. This is called an SNMP 'trap'. These appear in the event log of the SNMP manager. Most SNMP managers can be configured to give additional alerts in response to particular traps.

- **Management:**

Some SNMP agents support device management and configuration changes through the SNMP manager interface. This is not supported by IP Office.

IP Office SNMP operation has been tested against Castle Rock SNMPc-EE 5.1.6c and HP OpenView Network Node Manager 6.41.

### What Information is Available Via SNMP

As described above, SNMP information can either be polled by the SNMP application or received as the result of the IP Office sending SNMP trap information.

While the **.mib** files should not be edited, they can be read using a text editor and contain descriptions of all the various information objects that can be polled or sent and the information tha each object will include. For a list of the **.mib** files, see [Installing the IP Office MIB Files](#)<sup>[181]</sup>. The **NOTIFICATION-TYPE** objects are those used for [SNMP traps](#)<sup>[183]</sup>, the other types of objects are those that can be [polled](#)<sup>[183]</sup>.

### 11.14.1 Installing the IP Office MIB Files

To allow full communication between an SNMP agent and an SNMP manager, the SNMP manager must load MIB files (Management Information Base) specific to the SNMP agent device and the features it supports. These MIB files contain details of the information the agent can provide and the traps that it can send. Full details of the structure of the IP Office MIB files, MIB groups within those files and event traps can be found in the "IP Office Installation Manual".

The MIB files for IP Office operation are included on the IP Office DVD in the folder **\AdminCD\snmp\_mibs**. The actual files required and the method of loading depend on the SNMP manager application being used. The details below cover the two SNMP manager applications tested.

#### HP Open View Network Node Manager

1. Copy the following MIB files to the applications MIBs folder.

	MIB File	Source
a.	rfc2737-entity-mib.mib	snmp_mibs\standard folder on OpenView Install CD.
b.	avayagen-mib.mib	\AdminCD\snmp_mibs\IPOffice folder on IP Office Admin DVD.
c.	ipo-prod-mib.mib	\AdminCD\snmp_mibs\IPOffice folder on IP Office Admin DVD.
d.	ipo-mib.mib	\AdminCD\snmp_mibs\IPOffice folder on IP Office Admin DVD.
e.	inet-address-mib.mib	\AdminCD\snmp_mibs\Standard folder on IP Office Admin DVD.
f.	rfc2213-integrated-services-mib.mib	\AdminCD\snmp_mibs\standard folder on OpenView Install CD.
g.	diffserv-dscp-tc.mib	\AdminCD\snmp_mibs\Standard folder on IP Office Admin DVD.
h.	diffserv-mib-hpov.mib	\AdminCD\snmp_mibs\Standard folder on IP Office Admin DVD.
i.	ipo-phones-mib.mib	\AdminCD\snmp_mibs\IPOffice folder on IP Office Admin DVD.

2. Start the OpenView Network Node Manager console.
3. Select Options and then Load/Unload MIBs: SNMP.
4. Select Load and select all the MIB files listed above.
5. Select Compile.

---

## CastleRock SNMPc 5.1.6c and earlier

1. Copy the following MIB files to the applications MIBs folder, normally C:\Program Files\SNMPc Network Manager\mibfiles.

	MIB file	Source
a.	ENTITY-MIB	\AdminCD\snmp_mibs\Standard on IP Office Admin DVD.
b.	AVAYAGEN-MIB.mib	\AdminCD\snmp_mibs\IPOffice on IP Office Admin DVD.
c.	IPO-PROD-MIB.mib	\AdminCD\snmp_mibs\IPOffice on IP Office Admin DVD.
d.	IPO-MIB.mib	\AdminCD\snmp_mibs\IPOffice on IP Office Admin DVD.
e.	INET-ADDRESS-MIB.mib	\AdminCD\snmp_mibs\Standard on IP Office Admin DVD.
f.	INTEGRATED-SERVICES-MIB	\AdminCD\snmp_mibs\Standard on IP Office Admin DVD.
g.	DIFFSERV-DSCP-TC.mib	\AdminCD\snmp_mibs\Standard on IP Office Admin DVD.
h.	DIFFSERV-MIB.mib	\AdminCD\snmp_mibs\Standard on IP Office Admin DVD.
i.	IPO-PHONES-MIB.mib	\AdminCD\snmp_mibs\IPOffice on IP Office Admin DVD.

2. In SMNPc select Config | MIB Database.

3. Select Add and select the MIB files listed above in the order listed.

## CastleRock SNMPc V5.0.1

The MIB installation instructions provided above are correct for CastleRock SNMPc V5.0.8 and later. For V5.0.1 of CastleRock SNMPc the following must be carried out:

1. Copy all of the IP Office MIBs and standard MIBs from the IP Office Administrator Applications DVD to the SNMPc mibfiles directory.
2. In the SNMPc mibfiles directory open the files STANDARD.mib and SNMPv2-SMI.mib in Notepad.
3. In the SNMPv2-SMI.mib file find the definition of zeroDotZero and copy this to the clipboard.
4. In the STANDARD.MIB file find the SNMPv2-SMI section and paste in the definition of zeroDotZero from the clipboard before the end of this section (just before the END statement).
5. Save the modified STANDARD.MIB file.
6. Add the MIB file SNMP-FRAMEWORK-MIB.mib to the MIB database using the instructions provided in the IP Office installation guide.
7. Add all the MIB files listed in the instructions provided in the IP Office installation guide in the order given.
8. Compile the MIBs ready for use.

The reason for this is: The IPO-PHONES-MIB.mib relies upon the DIFFSERV-MIB.mib for the definition of the textual convention of IndexInteger. The DIFFSERV-MIB needs the definition of the textual convention zeroDotZero which is normally defined in SNMPv2-SMI.mib. However including SNMPv2-SMI.mib in the MIB file compilation list results in errors due to conflicts with what appear to be internal definitions within SNMPc and the SNMPv2-SMI section in its STANDARD.mib file. Therefore to resolve the issue the required definition of zeroDotZero must be placed in the SNMPv2-SMI section in SNMPc's STANDARD.mib file.

## 11.14.2 Enabling SNMP and Polling Support

In order for the IP Office control unit to be discovered and polled by an SNMP manager, its SNMP agent must be enabled and placed in the same read community as the SNMP manager.

1. In IP Office Manager, receive the control unit's configuration.
2. Double-click **System** from the Configuration Tree panel and select the SNMP tab.
3. Tick **SNMP Enabled**.
4. In **SNMP Port**, enter the UDP port number used by the IP Office SNMP agent to listen for and respond to SNMP traffic. The normal default is 161.
5. In **Community (Read-only)**, enter the community to which the device belongs for read access. This community name must match that used by the SNMP manager application when sending requests to the device. The community **public** is frequently used to establish communication and then changed (at both the SNMP agent and manager ends) for security.
6. Click **OK**.
7. Send the configuration back to the IP Office and select reboot.
8. Following the IP Office reboot, the SNMP manager should be able to discover the control unit.
9. The control unit's response will include details of the control unit type and the current level of core software.

## 11.14.3 Enabling SNMP Trap Sending

In IP Office Manager, receive the control unit's configuration.

1. Double-click **System** from the configuration tree panel and select the **System Events** tab.
2. Ensure that **SNMP Enabled** is ticked and set the other settings required for the SNMP Agent Configuration section.
3. Click the Alarms tab.
4. Click **Add...** and select **Trap** as the type of new alarm. You can add up to 2 SNMP traps, each with different destination and alarm settings.
  - **Server Address**  
Enter the IP address or fully-qualified domain name of the PC running the SNMP manager application.
  - **Port**  
Enter the Port on which the traps messages should be sent. This is the UDP port on which the IP Office sends SNMP trap messages. The default is 162.
  - **Community**  
Set the Community that will be used by the agent and the SNMP manager. The community **public** is frequently used to establish communication and then changed (at both the SNMP agent and manager ends) for security.
  - **Format**  
The default to use is IP Office. SMGR is only used for system being managed through Avaya SMGR.
  - **Minimum Severity Level**  
Set the alarm severity or higher for alarms that should be sent.
5. Select the **Events** which should be sent.
6. Click on **OK**.
7. Send the configuration back to the IP Office and select reboot.

---

## 11.15 Reset Button

IP500 V2 control units have a **Reset** button. Pressing the button while the control unit is starting up will pause the start up until the button is released. The effect of pressing the button during normal operation will depend on how long the button is pressed and is indicated by the CPU LED.

Press Duration (seconds)	CPU LED	Action	Summary
0 to 5.	Off	None	None.
5 to 10.	Orange	Reboot When Free	Reboot when free with new incoming/outgoing call barring. A reboot using the reset button is recorded in the Audit Trail.
10 to 30.	Flashing orange	Erase Configuration	Erase the configuration, alarm log and audit trail. Immediate reboot without waiting for active calls to end. See <a href="#">Erasing the configuration</a> <sup>[154]</sup> for full details.
30 to 40.	Red	Erase All.	Erase configuration, alarm log and core software. See <a href="#">Erasing the Operational Software</a> <sup>[188]</sup> for full details.
Over 40.	Flashing green	None	None.

## 11.16 AUX Button

IP500 V2 control units have an AUX button. This button can be used as follows.

- If pressed during a restart of the control unit, the control unit [skips booting](#)<sup>[124]</sup> from the */primary* folder on the System SD card.
- If pressed for more than 5 seconds when a system is running, the control unit shuts down for 10 minutes.



## 11.17 RS232 Port Maintenance

The RS232 port on the back of system control unit is not normally used when configuring an IP Office system. However, the port can be used for a number of maintenance processes.

- **⚠ WARNING**

Use of the RS232 port should only be performed if absolutely necessary and only if the actions cannot be completed using IP Office Manager or IP Office Web Manager. In all cases, you must make every effort to ensure that you have a backup copy of the system configuration.

### RS232 Port Maintenance Processes



1. [RS232 port cable connection and configuration](#) <sup>[367]</sup>
2. [Defaulting the configuration using debug](#) <sup>[156]</sup>
3. [Defaulting the configuration using the Boot Loader](#) <sup>[156]</sup>
4. [Defaulting the security using the RS232 port](#) <sup>[156]</sup>
5. [Defaulting the security using the Boot Loader](#) <sup>[160]</sup>
6. [Erasing the core software using debug](#) <sup>[187]</sup>
7. [Erasing the core software using the Boot Loader](#) <sup>[188]</sup>

---

## 11.18 Erasing the Core Software

When the firmware loaded by the control unit is erased, the control unit begins making BOOTP requests for replacement firmware files. IP Office Manager can act as a BOOTP server and respond to the control units request with the appropriate file from those installed with IP Office Manager.

Unlike other control units, when the firmware loaded by an IP500 V2 control unit is erased, the IP500 V2 control unit will first look for replacement firmware on its SD cards before falling back to using a BOOTP request to IP Office Manager.

-  Do not perform any of the following processes unless absolutely necessary. The IP Office software can normally be [upgraded using IP Office Manager](#)<sup>[164]</sup>.
-  This process erases the operational software. Before attempting this process you must know the MAC and IP addresses of the system, plus have a backup copy of its configuration and the correct .bin file for the control unit type and level of software.
-  The presence of any firewall blocking TFTP and or BOOTP causes this process to fail.

The processes below should be performed from a PC with a fixed IP address, directly connected to the IP Office control unit and with the IP Office system disconnected from any network. During the process, the control unit's IP address may default to a value in the 192.168.42.1 to 192.168.42.10 range. If this occurs, it may be necessary to amend the BOOTP entry in IP Office Manager to match the address the system is using.

### Process Options

1. [Erasing core software using the Reset button](#)<sup>[186]</sup>  
Note that this method also defaults the configuration.
2. [Erasing core software using Debug](#)<sup>[187]</sup>
3. [Erasing core software using the Boot Loader](#)<sup>[188]</sup>

### 11.18.1 Erasing Core Software Using the Reset Button

Read the note and the warnings regarding [erasing the core software](#)<sup>[186]</sup> before using this process. Also read and note the warnings regarding [defaulting the configuration](#)<sup>[154]</sup> before using this process.

#### To erase the core software and configuration using the Reset button

Use this process to reboot the system when free. Once invoked, the system bars any new incoming or outgoing calls until after the reboot.

1. Run IP Office Manager.
  - In the **BOOTP** entries, check that there is an entry that matches the MAC Address, IP Address and .bin file used by the system. An entry is normally automatically created when a configuration has been loaded from that IP Office. .
    - If an entry is not present, create a new entry manually. The first two details can be found in the Control Unit settings in the configuration file. Then close and restart IP Office Manager.
  - Under **File | Preferences** ensure that IP Office Manager is set to 255.255.255.255. Also check that **Enable BootP Server** is checked.
  - Select **View | TFTPLog**.
  - Check that the required .bin file is present in Manager's working directory.
2. On the rear of the control unit, press and hold the **Reset** button for between 30 to 40 seconds until the **CPU** led changes to red.
3. When the **CPU** LED changes to red, release the button.
4. The system erases its current software and sends out a BootP request on the network for new software.

## 11.18.2 Erasing Core Software Using Debug

Read the note and the warnings regarding [erasing the core software](#)<sup>[186]</sup> before using this process.

-  **WARNING**

Use of the RS232 port should only be performed if absolutely necessary and only if the actions cannot be completed using IP Office Manager or IP Office Web Manager. In all cases, you must make every effort to ensure that you have a backup copy of the system configuration.

### To erase the core software using Debug

1. Run IP Office Manager.

- In the **BOOTP** entries, check that there is an entry that matches the MAC Address, IP Address and .bin file used by the system. An entry is normally automatically created when a configuration has been loaded from that IP Office. .
  - If an entry is not present, create a new entry manually. The first two details can be found in the Control Unit settings in the configuration file. Then close and restart IP Office Manager.
- Under **File | Preferences** ensure that IP Office Manager is set to 255.255.255.255. Also check that **Enable BootP Server** is checked.
- Select **View | TFTPLog**.
- Check that the required .bin file is present in Manager's working directory.

2. Attach the serial cable between the PC and the RS232 DTE port on the IP Office control unit.

- a. Start the terminal program on your PC. Ensure that it has been setup as listed in [RS232 DTE Port Settings](#)<sup>[367]</sup>. Within a HyperTerminal session, the current settings are summarized across the base of the screen.
- b. Enter **AT** (note upper case). The control unit should respond **OK**.
- c. Enter **AT-DEBUG**. The control unit should response with the time and date and then **Hello>** to show it is ready to accept commands.

3. To erase the current configuration in RAM memory enter **upgrade**.

4. The IP Office will erase its current software and then send out a BootP request on the network for new software. IP Office Manager will respond and start transferring the software using TFTP.

---

## 11.18.3 Erasing Core Software Using the Boot Loader

Read the note and warnings regarding [erasing the core software](#)<sup>[186]</sup> before using this process.

- **⚠ WARNING**

Use of the RS232 port should only be performed if absolutely necessary and only if the actions cannot be completed using IP Office Manager or IP Office Web Manager. In all cases, you must make every effort to ensure that you have a backup copy of the system configuration.

### To erase the core software using the Boot Loader

1. Run IP Office Manager.

- In the **BOOTP** entries, check that there is an entry that matches the MAC Address, IP Address and .bin file used by the system. An entry is normally automatically created when a configuration has been loaded from that IP Office. .
  - If an entry is not present, create a new entry manually. The first two details can be found in the Control Unit settings in the configuration file. Then close and restart IP Office Manager.
- Under **File | Preferences** ensure that IP Office Manager is set to 255.255.255.255. Also check that **Enable BootP Server** is checked.
- Select **View | TFTPLog**.
- Check that the required .bin file is present in Manager's working directory.

2. Attach the serial cable between the PC and the RS232 DTE port on the IP Office control unit.

- a. Start the terminal program on your PC. Ensure that it has been setup as listed in [RS232 DTE Port Settings](#)<sup>[367]</sup>. Within a HyperTerminal session, the current settings are summarized across the base of the screen.
- b. Arrange the program windows so that the Terminal program and IP Office Manager TFTP Log are visible at the same time.
- c. Switch off power to the IP Office control unit.
- d. Power on the control unit and press the escape key every second until you get a Loader message. Below is an example.

```
P12 Loader 2.4
CPU Revision 0x0900
```

- e. Enter **AT** (note upper case). The control unit should respond **OK**.
- f. If an OK response is not received, check the settings of your terminal program and repeat the process above.

3. Enter **AT-X**. The control unit should respond **Multi-Sector Erase**.

4. The control unit will now request the .bin file it requires. For IP500 V2 control units this will be from files on the System SD card. For other control units it will be from IP Office Manager and appears in the TFTP Log.

5. If the file transfers does not appear to be taking place, check that the IP address shown in the TFTP Log matches the BOOTP entry. Adjust the BOOTP entry if necessary.

6. When completed the system will reboot.

## 11.19 Enabling IP Office Web Manager

Access to IP Office Web Manager is via the system's IP address and then selecting the **IP Office Web Management** link. In order to use IP Office Web Manager, a number of criteria as listed below must be met. Most of these are applied automatic to a new system installed with IP Office Release 8.0 or higher. However, for systems being upgraded to IP Office Release 8.0 or higher, additional upgrade steps may be required.

### Enabling IP Office Web Manager

1. The IP Office Web Manager files must be present on the System SD card. This can be done in a number of way:
  - By selecting to include those files when prompted to do so while [recreating the IP Office SD card](#)<sup>[126]</sup> using IP Office Manager.
  - By selecting **Upload System Files** when upgrading the system using IP Office Manager.
2. The IP Office system security must allow IP Office Web Manager operation:
  - This is done automatically for any new system installed with IP Office Release 8.0 or higher software.
  - This is done automatically for any existing pre-IP Office Release 8.0 system during the upgrade if the system is set to use the pre-IP Office Release 8.0 default password.
  - For any system upgraded to IP Office Release 8.0 without first being set back to the default password, either:
    - Using IP Office Manager:
      1. If not already done, select **View | Advanced View**.
      2. Select **File | Advanced | Erase Security Settings (Default)**.
      3. From the **Select IP Office** dialog, select the required system and click **OK**.
      4. Enter the user name **Administrator** and the password for that account.
      5. IP Office Manager will confirm if the action was successful or not.
    - Default the [system security settings using an RS232 DTE cable](#)<sup>[157]</sup>.



# Chapter 12.

# System Components

---

## 12. System Components

This section covers the individual components that can comprise an IP Office installation.

- [Control Units](#) <sup>[193]</sup>
- [IP500 Base Cards](#) <sup>[198]</sup>
- [IP500 Trunk Daughter Cards](#) <sup>[214]</sup>
- [IP500 External Expansion Modules](#) <sup>[219]</sup>
- [SD Cards](#) <sup>[196]</sup>
- [Mounting Kits](#) <sup>[241]</sup>
- [Phones](#) <sup>[242]</sup>
- [Phone Add-Ons](#) <sup>[325]</sup>
- [Ancilliary Systems](#) <sup>[337]</sup>
- [Applications](#) <sup>[339]</sup>
- [Physical Ports](#) <sup>[353]</sup>
- [Licenses](#) <sup>[368]</sup>

Additional information is included for:

- [Hardware Software Compatibility](#) <sup>[380]</sup>
- [Hardware PCS Levels](#) <sup>[388]</sup>
- [TAA Hardware](#) <sup>[388]</sup>



## 12.1 IP500 V2 Control Unit

The Avaya IP Office IP 500 V2 is also known as "IPO IP500 V2 Cntrl Unit", "IP Office IP 500 v2", "IPO IP500 v2", "IP 500 V2", "IP500 V2", "IPO 500v2 System Unit Assembly" or "IP Office 500 v2". Throughout this documentation the term IP500 V2 is used.

The slots are numbered 1 to 4 from left to right. They can be used in any order. However if the capacity for a particular type of card is exceeded, the card in the rightmost slot will be disabled. The unit must not be used with uncovered slots.

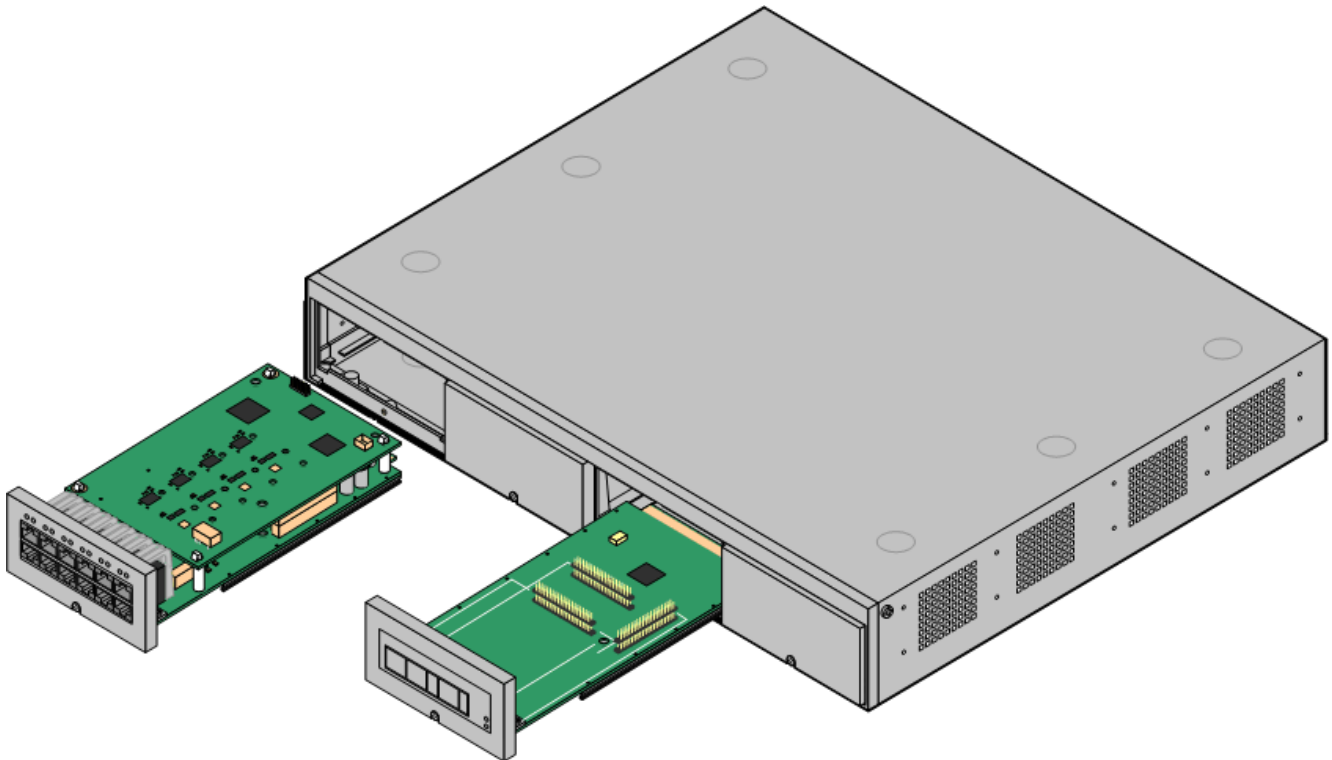

Feature	Capacity
<b>Maximum Extensions</b>	Up to 384 extensions in IP Office standard modes. Up to 100 extensions in IP Office Basic Edition modes.
<b>Conference Parties</b>	128 as standard but maximum 64 in any individual conference. Silence suppression is applied to conferences with more than 10 parties.
<b>Trunks Cards</b>	4 IP500 trunk daughter cards.
<b>Voice Compression Channels</b>	Up to 148 channels using up to IP500 VCM and IP500 Combination cards.
<b>Voicemail Channels</b>	Maximum 40 usable for Voicemail Pro/TAPI WAV connection sessions subject to available licenses. For Embedded Voicemail, up to 6 (2 by default, additional channels require licenses).
<b>Locales</b>	Supported in all <a href="#">IP Office locales</a> <sup>43</sup> .
<b>Software Level</b>	IP Office Essential Edition: 6.0 minimum. IP Office Basic Edition - PARTNER® Mode: 6.0 minimum. IP Office Basic Edition - Norstar Mode: 6.1 minimum. IP Office Basic Edition: 7.0 minimum. Bin file = ip500v2.bin.
<b>Power Supply</b>	Internal power supply unit.
<b>Mounting</b>	Free-standing, rack mounted (requires IPO IP500 RACK MNTG KIT) or wall mounted (requires IPO IP500 WALL MNTG KIT).
<b>Dimensions</b>	Width: 445mm/17.5". Depth: 365mm/14.4". Height: 73mm/2.9"/2U. Clearance: 90mm minimum all sides, 220mm at front.
<b>Memory</b>	Maximum configuration file size: 2048KB.

Name		Description	Country	SAP Code
IP500 V2 Control Units	IPO IP500 V2 Cntrl Unit	IP Office 500 V2 Control Unit		700476005
	IPO IP500 V2 Cntrl Unit TAA	" <a href="#">Trade Agreements Act</a> <sup>[388]</sup> compliant variant.		700501510
Avaya SD Memory Card	IPO IP500 V2 SYS SD CARD AL	IP500 V2 A-Law SD Card		700479702
	IPO IP500 V2 SYS SD CARD MUL	IP500 V2 U-Law SD Card		700479710
	IPO IP500 V2 SYS SD CARD PARTNER	IP500 V2 PARTNER SD Card		700479728
	IPO IP500 V2 SYS SD CARD NORSTAR	IP500 V2 Norstar SD Card		700500948
IEC60320 C13 Earthed Power Cord 	IPO - PWR LEAD (EARTHED) EU CEE7/7	CEE7/7	Europe	700289762
	IPO - PWR LEAD (EARTHED) UK	BS1363	United Kingdom	700289747
	IPO - PWR LEAD (EARTHED) US	NEMA5-15P	America	700289770
Mounting Kits	IPO IP500 RACK MNTG KIT V3	IPO IP500 WALL MNTG KIT V3		700503160
Miscellaneous	IP500 Blanking Plate Kit	IP500 Blanking Plate Kit		700429194

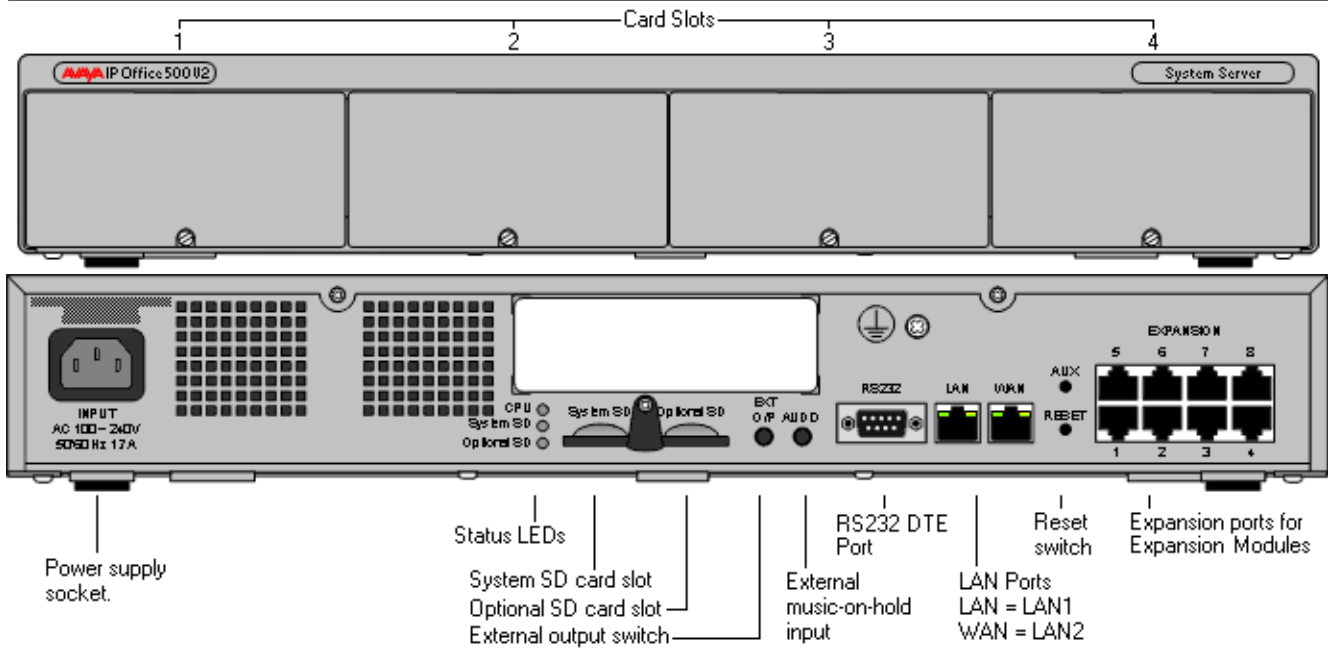

Ports	Description
<b>AUDIO</b> <sup>(356)</sup>	3.5mm Stereo jack socket. Used for external music on hold source input.
<b>AUX</b> <sup>(124)</sup>	<ul style="list-style-type: none"> <li>If pressed during a restart of the control unit, the control unit <a href="#">skips booting</a> <sup>(124)</sup> from the <i>/primary</i> folder on the System SD card.</li> <li>If pressed for more than 5 seconds when a system is running, the control unit shuts down for 10 minutes.</li> </ul>
<b>CPU</b>	Indicates the status of the control unit. <ul style="list-style-type: none"> <li><b>Alternate red/green</b> = Starting up.</li> <li><b>Green on</b> = Okay.</li> <li><b>Red on</b> = No software.</li> <li><b>Flashing Red</b> = Error/Shutdown.</li> </ul>
<b>EXPANSION</b> <sup>(362)</sup>	RJ45 socket. Used for direct connection to external expansion modules using the Expansion Interconnect cable supplied with the expansion module.
<b>EXT O/P</b> <sup>(176)</sup>	3.5mm Stereo jack socket. Used for switching external relay systems such as door entry controls. The port contains two independent switches controlled by the IP Office.
<b>INPUT</b> <sup>(31)</sup>	AC power input port.
<b>LAN</b> <sup>(363)</sup>	RJ45 socket. The port is a full-duplex 10/100Mbps auto-sensing, MDI crossover port. With the WAN port forms a managed layer 3 Ethernet switch.
<b>Optional SD</b> <sup>(122)</sup>	Used for the Optional SD card. The LED is used in the same way as for the System SD (see below).
<b>RESET</b> <sup>(184)</sup>	This switch is used to restart the IP Office, optionally erasing the configuration and or the core software in the process. See <a href="#">Reset Button</a> <sup>(184)</sup> .
<b>RS232</b> <sup>(367)</sup>	9-Way D-Type socket. Used for system maintenance.
<b>System SD</b> <sup>(122)</sup>	Used for the System SD card,. The LED is used as follows. <ul style="list-style-type: none"> <li><b>Off</b> = Card shutdown.</li> <li><b>Green on</b> = Card present.</li> <li><b>Green flashing</b> = Card in use.</li> <li><b>Orange steady</b> = Reset imminent.</li> <li><b>Red flashing</b> = Card initializing or shutting down.</li> <li><b>Red fast flashing</b> = card full</li> <li><b>Red steady</b> = Card failure/wrong type.</li> </ul>
<b>WAN</b> <sup>(363)</sup>	RJ45 socket. The port is a full-duplex 10/100Mbps auto-sensing, MDI crossover port. With the WAN port forms a managed layer 3 Ethernet switch. This port is not supported on systems running in IP Office Basic Edition - PARTNER® Mode, IP Office Basic Edition - Norstar Mode or IP Office Basic Editions.
	Used for connection of a <a href="#">functional or protective ground</a> <sup>(90)</sup> . Use of a ground for all systems is recommended and for some locales may be a regulatory requirement.

## 12.2 IP500 V2 System SD Cards

This type of card is used with IP500 V2 control units and is a mandatory item. The control unit must be fitted with one of these feature keys even if no licenses are being used.

The serial number for licenses issued for use with this type of card is printed on the card label and prefixed by **FK**. This type of card is also used for other system functions and to provide Embedded Voicemail if required.



- By default the card can be used for 2 ports of Embedded Voicemail. Additional ports up to a maximum of 6 can be enabled by the addition of [licenses](#)<sup>[369]</sup>. The voicemail mailbox message and prompt capacity supports 2 simultaneous connections and 15 hours of storage. This can be expanded up to 6 channels by the addition of licenses, each of which enables an additional two channels and an additional 5 hours of storage.
- **WARNING**  
These cards should only be formatted using IP Office Manager or System Status Application. The cards should only be removed from a system after either a [card shut down](#)<sup>[146]</sup> or a [system shut down](#)<sup>[147]</sup>.

Feature Key Dongle	SAP Code
IPO IP500 V2 SYS SD CARD A-LAW	700479702
IPO IP500 V2 SYS SD CARD MU-LAW	700479710
IPO IP500 V2 SYS SD CARD PARTNER	700479728
IPO IP500 V2 SYS SD CARD NORSTAR	700500948

- **IP Office U-Law SD Card**  
A system fitted with this type of card defaults to U-Law telephony. For pre-IP Office Release 7.0 software, the system will default to IP Office standard mode. For IP Office Release 7.0+, the system will default to IP Office Basic Edition **Key System** operation. Intended for North American locales.
- **IP Office A-Law SD Card**  
A system fitted with this type of card defaults to A-Law telephony. For pre-IP Office Release 7.0 software, the system will default to IP Office standard mode. For IP Office Release 7.0+, the system will default to IP Office Basic Edition **PBX System** operation. Intended for locales outside North America.
- **IP Office Partner Edition SD Card**  
A system fitted with this type of card defaults to U-Law telephony and IP Office Basic Edition - PARTNER® Mode **Key System** operation. Supported only in North American locales.
- **IP Office Norstar Edition SD Card**  
A system fitted with this type of card defaults to A-Law telephony and IP Office Basic Edition - Norstar Mode **Key System** operation. Supported only in Middle East and North African locales.

## Embedded Voicemail

The System SD card can be used to provide Embedded Voicemail for the system. Unlicensed, the Embedded Voicemail provided by the system supports 2 simultaneous connections and 15 hours of storage. This can be expanded up to 6 channels by the addition of [licenses](#)<sup>[369]</sup>, each of which enables an additional two channels and an additional 5 hours of storage.

For full details of Embedded Voicemail setup and configuration, refer to the Embedded Voicemail Installation manual. The cards are preloaded with the following languages:

- Arabic, Chinese-Mandarin, Chinese-Cantonese, Danish, Dutch, English-UK, English-US, Finnish, French, French-Canadian, German, Italian, Korean, Norwegian, Portuguese, Portuguese Brazilian, Russian, Swedish, Spanish, Spanish-Latin, Spanish-Argentinean.

## PCM Encoding

- **A-Law or Mu-Law**

PCM (Pulse Code Modulation) is a method for encoding voice as data. In telephony, two methods PCM encoding are widely used, A-law and Mu-law (also called U-law). Typically Mu-law is used in North America and a few other locations while A-law by the rest of the world. As well as setting the correct PCM encoding for the region, the A-Law or Mu-Law setting of an IP Office system when it is first started affects a wide range of regional defaults relating to line settings and other values.

- For IP500 V2 systems, the encoding default is set by the type of System SD card installed when the system is first started.

## 12.3 IP500 Base Cards

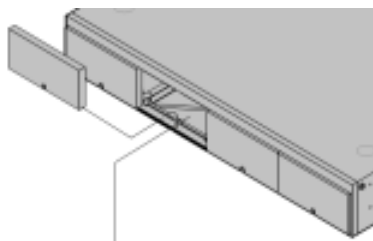

The IP500 V2 control unit has 4 slots for the insertion of IP500 base cards. The slots are numbered 1 to 4 from left to right. Normally they can be used in any order, however if the capacity for a particular type of card is exceeded, the card in the rightmost slot will be disabled.

Each base card includes an integral front panel with ports for cable connections. Typically the first 8 ports on the left are for connection of extension devices. The 4 ports on the left are used for connection of trunks if a [trunk daughter card](#)<sup>[24]</sup> is added to the base card.

### [IP500 Digital Station Base Card](#)<sup>[208]</sup>



This card provides 8 DS (digital station) ports for the connection of Avaya digital phones.

- The card can be fitted with an [IP500 trunk daughter card](#)<sup>[24]</sup> which uses the base card ports for trunk connection.
- **Maximum:** 3 per control unit.
  - 4400 Series phones (4406D, 4412D and 4424D) are not supported on this card. They are supported on external expansion module DS ports.
  - Connections for 4100, 7400, M-Series and T-Series phones use the IP500 TCM8 Digital Station card.

### [IP500 Analog Phone Base Card](#)<sup>[202]</sup>

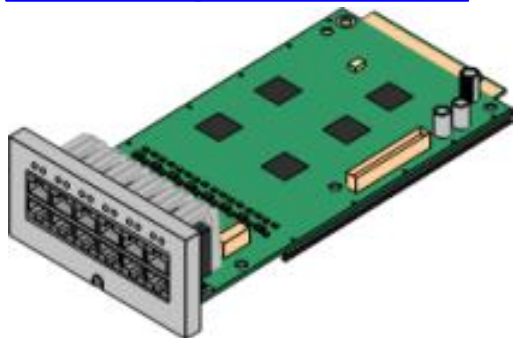

The card is available in two variants, supporting either 2 or 8 analog phone ports.

- The card can be fitted with an [IP500 trunk daughter card](#)<sup>[24]</sup> which uses the base card ports for trunk connection.
- **Maximum:** 4 per control unit.
  - The analog phone ports do not include a ringing capacitor. Where this is a requirement, connection should be via a Master socket containing ringing capacitors.
  - If fitted with an IP500 Analog Trunk daughter card, during power failure phone port 8 is connected to analog trunk port 12.

### [IP500 TCM8 Digital Station Card](#)<sup>[21]</sup>

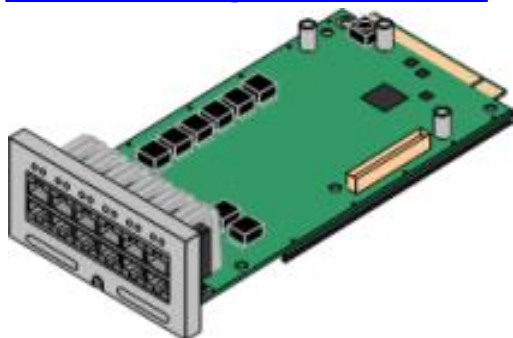

This card provides 8 BST (digital station) ports for the connection of Avaya 4100, 7400, M-Series and T-Series phones.

- The card can be fitted with an [IP500 trunk daughter card](#)<sup>[24]</sup> which uses the base card ports for trunk connection.
- **Maximum:** 4 per control unit per IP500 V2 control unit. Not supported by IP500 control units.

### [IP500 VCM Base Card](#)<sup>[212]</sup>

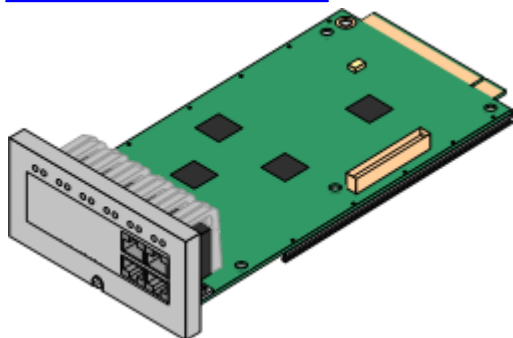

This card is available in variants supporting either 32 or 64 voice compression channels for use with VoIP calls.

- The card can be fitted with an [IP500 trunk daughter card](#)<sup>[24]</sup> which uses the base card ports for trunk connection.
- **Maximum:** 2 per control unit.

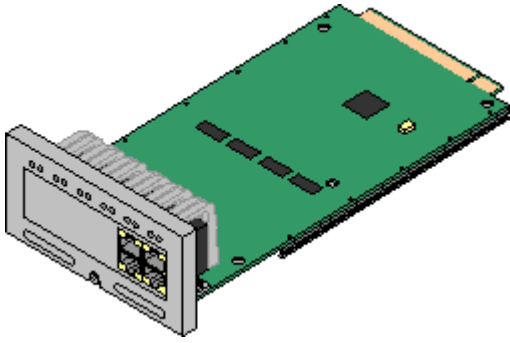
**IP500 4-Port Expansion Base Card** <sup>201</sup>

This card adds an additional 4 expansion ports for external expansion modules. The card is supplied with four 2m yellow interconnect cables.

- This card does not accept any IP500 trunk daughter card.
- **Maximum:** 1 per control unit (Right-hand slot 4 only).
- **Supported Expansion Modules:** The following external expansion modules are supported:
  - IP500 Analogue Trunk Module
  - IP500 Digital Station Module A
  - IP500 BRI So Module
  - IP500 Digital Station Module B
  - IP500 Digital Station Module
  - IP500 Phone Module

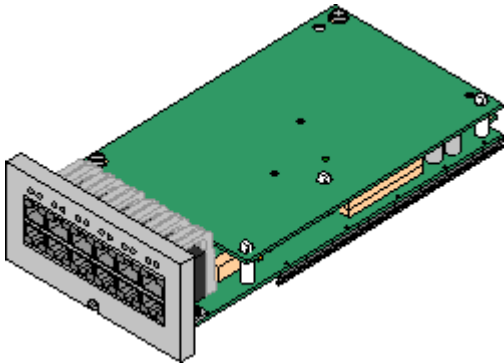
**IP500 BRI Combination Card** <sup>206</sup>

This card provides 6 digital station ports (1-6), 2 analog extension ports (7-8) and 2 BRI trunk ports (9-10, 4 channels). The card also includes 10 voice compression channels.

- **Maximum:** 2 combination cards per IP500 V2 control unit, regardless of type.
  - IP500 Combination cards are pre-fitted with a trunk daughter card which cannot be removed or changed for another type/ capacity trunk daughter card.
  - IP Office Basic Edition - Norstar Mode and IP Office Basic Edition systems are limited to a maximum of 12 BRI channels using BRI Combination and or BRI trunk daughter cards.

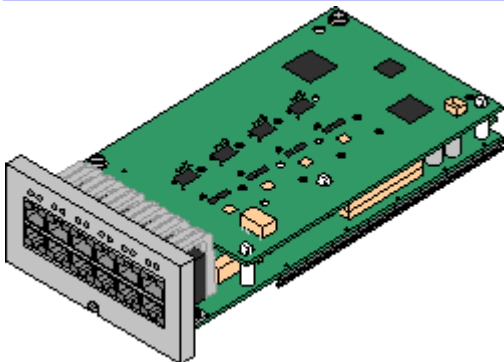
**IP500 ATM Combination Card/IP500 ATM Combination Card V2** <sup>203</sup>

This card provides 6 digital station ports (1-6), 2 analog extension ports (7-8) and 4 analog trunk ports (9-12). The card also includes 10 voice compression channels.

- **Maximum:** 2 combination cards per IP500 V2 control unit, regardless of type.
  - IP500 Combination cards are pre-fitted with a trunk daughter card which cannot be removed or changed for another type/ capacity trunk daughter card.
  - The analog phone ports do not include a ringing capacitor. Where this is a requirement, connection should be via a Master socket containing ringing capacitors.
  - If fitted with an IP500 Analog Trunk daughter card, during power failure phone port 8 is connected to analog trunk port 12.

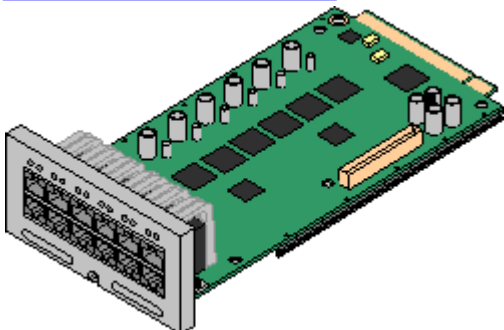
**IP500 ETR6 Base Card** <sup>209</sup>

This card is only supported in an IP500 V2 control unit running in IP Office Basic Edition - PARTNER® Mode or IP Office Basic Edition. It provides 6 ETR ports for connection of ETR phones. 2 Analog extension ports are also provided for emergency use only with an analog trunk card.

- The card can be fitted with an IP500 trunk daughter card which uses the base card ports for trunk connection.
- **Maximum:** 3 per IP500 V2 control unit.
- The analog phone ports do not include a ringing capacitor. Where this is a requirement, connection should be via a Master socket containing ringing capacitors.
- If fitted with an IP500 Analog Trunk daughter card, during power failure phone ports 7 and 8 are connected to analog trunk port 12. However during normal operation analog phone ports 7 and 8 are not useable.

**Unified Communications Module** <sup>207</sup>



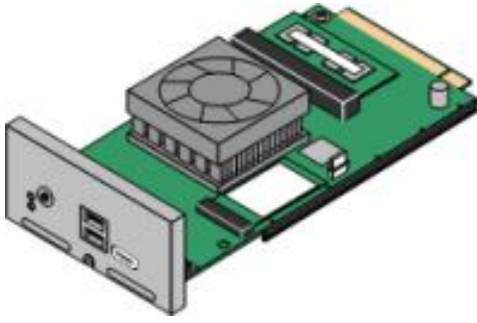

This card acts as an embedded Linux server for the one-X Portal for IP Office and/or Voicemail Pro applications.



### 12.3.1 4-Port Expansion Card

This card is used to add 4 additional expansion ports to the control unit. This card is only supported in slot 4.

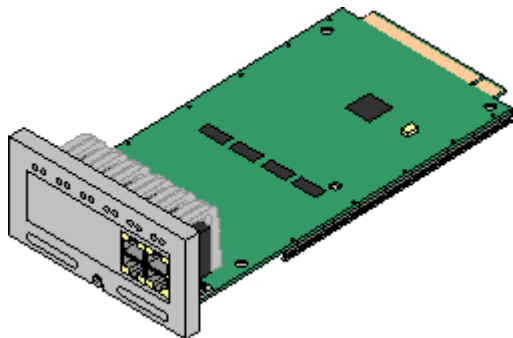

- **Supports**  
Provides 4 additional [expansion ports](#) <sup>(362)</sup> for connection of external expansion modules.
- **Supported Expansion Modules:** The following external expansion modules are supported:
  - IP500 Analogue Trunk Module
  - IP500 Digital Station Module A
  - IP500 BRI So Module
  - IP500 Digital Station Module B
  - IP500 Digital Station Module
  - IP500 Phone Module
- **Maximum per Control Unit:** 1 - Right hand slot 4 only.
- **IP500 Trunk Card Support:** **X**.

- Each external expansion module is supplied with a blue 1 meter (3'3") expansion interconnect cable. This cable must be used when connecting to expansion ports on the rear of a control unit.
- When connecting to expansion ports on an IP500 4-Port Expansion card, a yellow 2 meter (6'6") expansion interconnect cable can be used in place of the standard blue cable. 4 Yellow cables are supplied with the IP500 4-Port Expansion card.

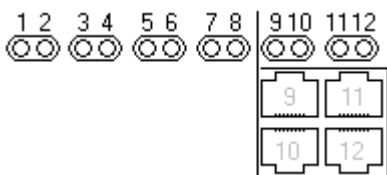

- LEDs 1 to 8 are used for the expansion ports on the rear of the control unit. LEDs 9 to 12 are used for the card's own expansion ports.

<b>Green</b>	<b>On</b>	Expansion module present.
<b>Red</b>	<b>Flashing</b>	Initializing.
<b>Red</b>	<b>On</b>	Error.
<b>Orange</b>	<b>Regular Flash</b>	Base card okay.

Name	Description	SAP Code
<b>IPO IP500 EXP CARD 4PT</b>	Includes 4 yellow 2 metre interconnect cables.	700472889
<b>IPO EXP CABLE RJ45/RJ45 2M YELLOW</b>	Only for use with the 4-Port Expansion card.	700472871

## 12.3.2 Analog Phone

This card is used to add analog phone ports to the control unit. It is available in two variants, providing either 2 or 8 analog extension ports.

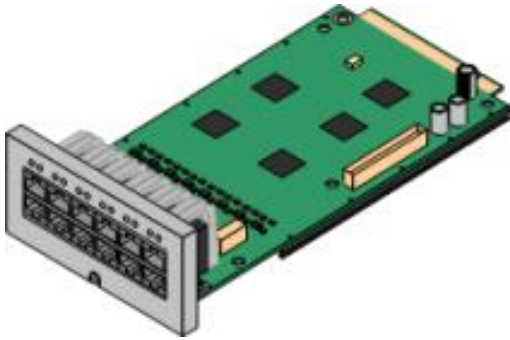

- **Supports**  
Provides either 8 or 2 [analog](#) <sup>(356)</sup> phone ports depending on card variant.
- **Maximum per Control Unit:** 4.
- **IP500 Trunk Card Support:** ✓ 1.

Port Type	Ports	Features
<b>Analog Phone</b>	<b>1 to 8</b>	<ul style="list-style-type: none"> <li>• Supports ICLID modes DTMFA, DTMFC, DTMFD, FSK and UK20.</li> <li>• REN 2 (1 for external bell device).</li> <li>• Off-Hook current: 25mA</li> <li>• Ring Voltage: 40V.</li> <li>• Intended for connection to two-wire analog phones, the ports do not include a ringing capacitor. For connection to 4-wire analog phones, connection should be via a master socket with ringing capacitors.</li> <li>• If fitted with an analog trunk card, for the Phone 8, during power failure extension port 8 is connected to the analog trunk port 12.</li> </ul> <p><b>Port LEDs</b></p> <ul style="list-style-type: none"> <li>• No status LEDs are used for analog phone extensions.</li> <li>• LED1 is also used for base card status: <ul style="list-style-type: none"> <li>• <b>Red On</b> = Error</li> <li>• <b>Red Slow Flash</b> = Initializing.</li> <li>• <b>Red Flash every 5 seconds</b> = Card okay.</li> <li>• <b>Red Fast Flash</b> = System shutdown.</li> </ul> </li> </ul>
<b>Optional Trunk Card Ports</b>	<b>9 to 12</b>	<p>The card can be fitted with one trunk daughter card of any type. The trunk daughter card then uses ports 9 to 12 on the base card for its trunk connections.</p> <p><b>Port LEDs</b></p> <p>LED use depends on the type of daughter card installed on the base card:</p> <ul style="list-style-type: none"> <li>• LED 9 is also used for daughter card status. <ul style="list-style-type: none"> <li>• <b>Red On</b> = Error</li> <li>• <b>Red Slow Flash</b> = Initializing.</li> <li>• <b>Red Flash every 5 seconds</b> = Card okay.</li> <li>• <b>Red Fast Flash</b> = System shutdown.</li> </ul> </li> </ul> <p><b>Analog Card</b></p> <ul style="list-style-type: none"> <li>• <b>Green on</b> = V1: Card installed. V2: Line connected to the port but idle.</li> <li>• <b>Green flashing</b> = Line in use.</li> </ul> <p><b>PRI Card</b></p> <ul style="list-style-type: none"> <li>• <b>Off</b> = No trunk present.</li> <li>• <b>Green on</b> = Trunk present.</li> <li>• <b>Green flashing</b> = Trunk in use.</li> <li>• <b>Red/Green Fast Flash</b> (port 9) or <b>Green Fast Flash</b> (port 10) = Alarm indication signal (AIS) from the trunk remote end.</li> <li>• <b>Red with Green Blink</b> (port 9) or <b>Green Blink</b> (port 10) = Port in loopback mode (set through IP Office System Monitor).</li> </ul> <p><b>BRI Card</b></p> <ul style="list-style-type: none"> <li>• <b>Off</b> = No trunk present.</li> <li>• <b>Green on</b> = Trunk present.</li> <li>• <b>Green flashing</b> = Trunk in use.</li> </ul>

Name	Description	SAP Code
<b>IPO 500 Extn Card Phone 2</b>	IP Office 500 Extension Card Phone 2	700431778
<b>IPO 500 Extn Card Phone 8</b>	IP Office 500 Extension Card Phone 8	700417231

### 12.3.3 ATM Combination Card

These cards are used to add a combination of ports to an IP500 V2 control unit. Not supported by IP500 control units. The newer IP500 ATM Combination Card V2 version is supported by IP Office Release 8.1 Feature Pack 1 and higher only.

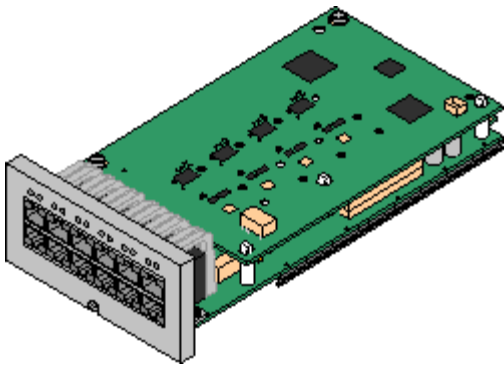

#### • Supports

- 10 voice compression channels. Codec support is G.711, G729a and G.723 with 64ms echo cancellation. G.722 is supported by IP Office Release 8.0 and higher.
- 6 Digital Station ports for supported [Avaya DS digital telephones](#) <sup>[36]</sup> (except 3800 and 4400 Series).
- 2 Analog Extension ports.
- 4 Analog Trunk ports:  
Depending on the version of combination card, V1 or V2, the analog trunk daughter card is equivalent to an [IP500 Analog Trunk Card 4](#) <sup>[215]</sup> V1 or V2 respectively.
- During power failure phone port 8 is connected to analog trunk port 12.
- **Maximum per Control Unit:** 2 combination cards of any type per IP500 V2 control unit.
- **IP500 Trunk Card Support:** ✓ 1.
  - IP500 Combination cards are pre-fitted with a trunk daughter card which cannot be removed or changed for another type/capacity trunk daughter card.
- **IP Office Software Level:** 6.0+.  
This depends on the version of the card as follow:
  - **V1:** 6.0+. New build PCS04 cards are only supported in systems running IP Office Release 6.1(20), 7.0(12) or 8.0 and higher. Refer to IP Office Technical Tip 237.
  - **V2:** IP Office Release 8.1 Feature Pack 1 or higher.

Port Type	Ports	Features
<b>Digit Station</b>	<b>1 to 6</b>	<p>Provides <a href="#">DS</a> <sup>[36]</sup> ports for supported <a href="#">Avaya DS digital telephones</a> <sup>[39]</sup> (except 3800 and 4400 Series).</p> <p><b>LEDs</b></p> <ul style="list-style-type: none"> <li>• <b>Green Flashing</b> = Phone detected.</li> <li>• <b>Green On</b> = Phone active.</li> <li>• LED1 is also used for base card status:               <ul style="list-style-type: none"> <li>• <b>Red On</b> = Error</li> <li>• <b>Red Flash every 5 seconds</b> = Card okay.</li> <li>• <b>Red Slow Flash</b> = Initializing.</li> <li>• <b>Red Fast Flash</b> = System shutdown.</li> </ul> </li> </ul>
<b>Analog Phone</b>	<b>7 to 8</b>	<ul style="list-style-type: none"> <li>• Supports ICLID modes DTMFA, DTMFC, DTMFD, FSK and UK20.</li> <li>• REN 2 (1 for external bell device).</li> <li>• Off-Hook current: 25mA</li> <li>• Ring Voltage: 40V.</li> <li>• Intended for connection to two-wire analog phones, the ports do not include a ringing capacitor. For connection to 4-wire analog phones, connection should be via a master socket with ringing capacitors.</li> <li>• During power failure extension port 8 is connected to the analog trunk port 12.               <ul style="list-style-type: none"> <li>• No status LEDs are used for analog phone extensions.</li> </ul> </li> </ul>
<b>Analog Trunk</b>	<b>9 to 12</b>	<ul style="list-style-type: none"> <li>• DTMF, ICLID and busy tone detection.</li> <li>• Over-voltage/lightning protection (may still require <a href="#">additional protection equipment</a> <sup>[36]</sup>).</li> <li>• DTMF and LD (loop disconnect) dialing.</li> <li>• Echo cancellation.</li> </ul> <p><b>LEDs</b></p> <ul style="list-style-type: none"> <li>• <b>Green on</b> = V1: Card installed. V2: Line connected to the port but idle.</li> <li>• <b>Green flashing</b> = Line in use.</li> <li>• LED 9 is also used for daughter card status.               <ul style="list-style-type: none"> <li>• <b>Red On</b> = Error</li> <li>• <b>Red Flash every 5 seconds</b> = Card okay.</li> </ul> </li> </ul>

---

Port Type	Ports	Features
		<ul style="list-style-type: none"><li>• <b>Red Slow Flash</b> = Initializing.</li><li>• <b>Red Fast Flash</b> = System shutdown.</li></ul>

Name	Description	SAP Code
IPO IP500 V2 COMB CARD ATM4	IPO IP500 V2 COMBINATION CARD ATM4	700476013
IPO IP500 V2 COMB CARD ATM4 TAA	" <a href="#">Trade Agreements Act</a> <sup>388</sup> compliant variant.	700501513
IPO IP500 V2 COMB CARD ATM4 V2	IPO IP500 V2 COMBINATION CARD ATM4 V2	700504556

### 12.3.4 BRI Combination Card

This card is used to add a combination of ports to an IP500 V2 control unit.

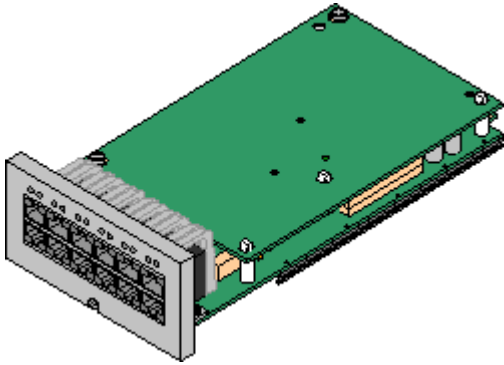

- **Supports**
  - 10 voice compression channels. Codec support is G.711, G729a and G.723 with 64ms echo cancellation. G.722 is supported by IP Office Release 8.0 and higher.
  - 6 Digital Station ports for supported [Avaya DS digital telephones](#) <sup>[39]</sup> (except 3800 and 4400 Series).
  - 2 Analog Extension ports.
  - 2 BRI Trunk ports (4 BRI channels).
- **Maximum per Control Unit:** 2 combination cards of any type.
  - IP Office Basic Edition - Norstar Mode and IP Office Basic Edition systems are limited to a maximum of 12 BRI channels using BRI Combination and or BRI trunk daughter cards.
- **IP500 Trunk Card Support:** ✓ 1.
  - IP500 Combination cards are pre-fitted with a trunk daughter card which cannot be removed or changed for another type/ capacity trunk daughter card.

Port Type	Ports	Features
<b>Digit Station</b>	<b>1 to 6</b>	Provides <a href="#">DS</a> <sup>[36]</sup> ports for supported <a href="#">Avaya DS digital telephones</a> <sup>[39]</sup> (except 3800 and 4400 Series).  <b>LEDs</b> <ul style="list-style-type: none"> <li>• <b>Green Flashing</b> = Phone detected.</li> <li>• <b>Green On</b> = Phone active.</li> <li>• LED1 is also used for base card status:                             <ul style="list-style-type: none"> <li>• <b>Red On</b> = Error</li> <li>• <b>Red Flash every 5 seconds</b> = Card okay.</li> <li>• <b>Red Slow Flash</b> = Initializing.</li> <li>• <b>Red Fast Flash</b> = System shutdown.</li> </ul> </li> </ul>
<b>Analog Phone</b>	<b>7 to 8</b>	<ul style="list-style-type: none"> <li>• Supports ICLID modes DTMFA, DTMFC, DTMFD, FSK and UK20.</li> <li>• REN 2 (1 for external bell device).</li> <li>• Off-Hook current: 25mA</li> <li>• Ring Voltage: 40V.</li> <li>• Intended for connection to two-wire analog phones, the ports do not include a ringing capacitor. For connection to 4-wire analog phones, connection should be via a master socket with ringing capacitors.                             <ul style="list-style-type: none"> <li>• No status LEDs are used for analog phone extensions.</li> </ul> </li> </ul>
<b>BRI Trunk</b>	<b>9 to 10</b>	<ul style="list-style-type: none"> <li>• Each trunk port supports 2B+D channels.</li> <li>• ETSI or AusTS013 basic rate protocol set through the IP Office configuration.</li> </ul> <b>LEDs</b> <ul style="list-style-type: none"> <li>• <b>Off</b> = No trunk present.</li> <li>• <b>Green on</b> = Trunk present.</li> <li>• <b>Green flashing</b> = Trunk in use.</li> <li>• LED 9 is also used for daughter card status.                             <ul style="list-style-type: none"> <li>• <b>Red On</b> = Error</li> <li>• <b>Red Flash every 5 seconds</b> = Card okay.</li> <li>• <b>Red Slow Flash</b> = Initializing.</li> <li>• <b>Red Fast Flash</b> = System shutdown.</li> </ul> </li> </ul>
<b>Not Used</b>	<b>11 to 12</b>	-

Name	Description	SAP Code
IPO IP500 V2 COMB CARD BRI	IPO IP500 V2 COMBINATION CARD BRI	700476021

### 12.3.5 Unified Communications Module

This card is an embedded server that allows Linux based IP Office applications to be run within the IP Office control unit rather than requiring separate PCs. The IP address of the server is set during its initial configuration and can then be changed through web browser access to the server.

There are two type of card. The Unified Communications Module v2 is supported by IP Office Release 9.1 and higher. The Unified Communications Module v1 is supported for IP Office Release 8.0 Q1 2012 Service Pack or higher. Though physically different, the two types of card current support the same applications and application capacities. However, the v2 does not provide an implied Preferred Edition license and is not supplied with pre-installed software.

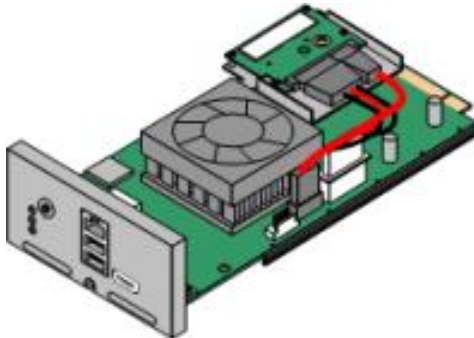

Unified Communications Module v1

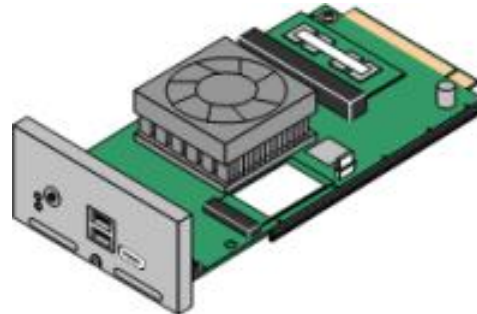

Unified Communications Module v2

- **Supports**

Voicemail Pro and or one-X Portal for IP Office applications. The card is not supported by systems running in IP Office Basic Edition mode.

- **IP Office Users:** Up to 200 users when running Voicemail Pro and one-X Portal for IP Office. More than 200 users when running just Voicemail Pro.
- **Simultaneous one-X Portal for IP Office Users:** 50.
- **Maximum voicemail ports:** Up to 20 ports when running Voicemail Pro and one-X Portal for IP Office. Up to 40 ports when running just Voicemail Pro.
- **Small Community Network:** Maximum 6 systems.

- **Licenses**

For both card types, an **Essential Edition** license is required as a pre-requisite. The voicemail server on the card also requires the system to have a **Preferred Edition** license.

- The Unified Communications Module v1 acts as an automatic **Preferred Edition** license for the IP Office system.
- For the Unified Communications Module v2, a separately installed **Preferred Edition** license is required.

- **Maximum per Control Unit:** 1 per control unit.

- **IP500 Trunk Card Support:** ✗

- **! WARNING:**

The Unified Communications Module v1 card is supplied with a removable plastic cover that locates over the external ports (LAN, USB and HDMI) on the faceplate of the card. This cover should always be in place during normal operation of the card. The cover should only be temporarily removed during maintenance actions that require access to the ports and should be replaced when the maintenance is completed.

- **! WARNING: Card Remains Hot After System Shutdown**

When removing an Unified Communications Module from a system, care should be taken not to touch the heat sink on the module. The heat sink remains hot for a long period after system shutdown.

Name	Description	SAP Code
IPO UC MODULE	IP Office Unified Communications Module v1	700501442
IPO UC MODULE V2	IP Office Unified Communications Module v2	700507449

## 12.3.6 Digital Station

This card is used to add digital station (DS) extension ports to an IP500 and IP500 V2 control unit. It provides 8 RJ45 DS extension ports for use with supported [Avaya DS digital telephones](#)<sup>[39]</sup>. A further 4 RJ45 ports are provided for trunk connections when an IP500 trunk card is fitted to this card.

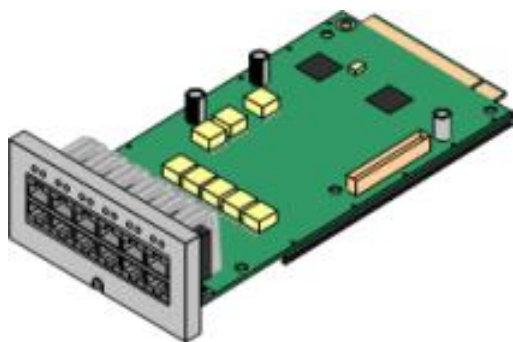

- **Supports**  
Provides 8 [DS](#)<sup>[36b]</sup> ports for [Avaya DS digital telephones](#)<sup>[39]</sup> (except 3800 and 4400 Series).
- **Maximum per Control Unit:** 3 per control unit.
- **IP500 Trunk Card Support:** ✓ 1.

Port Type	Ports	Features
<b>Digit Station</b>	<b>1 to 8</b>	<p>Provides <a href="#">DS</a><sup>[36b]</sup> ports for supported <a href="#">Avaya DS digital telephones</a><sup>[39]</sup> (except 3800 and 4400 Series).</p> <p><b>LEDs</b></p> <ul style="list-style-type: none"> <li>• <b>Green Flashing</b> = Phone detected.</li> <li>• <b>Green On</b> = Phone active.</li> <li>• LED1 is also used for base card status: <ul style="list-style-type: none"> <li>• <b>Red On</b> = Error</li> <li>• <b>Red Flash every 5 seconds</b> = Card okay.</li> <li>• <b>Red Slow Flash</b> = Initializing.</li> <li>• <b>Red Fast Flash</b> = System shutdown.</li> </ul> </li> </ul>
<b>Optional Trunk Card Ports</b>	<b>9 to 12</b>	<p>The card can be fitted with one trunk daughter card of any type. The trunk daughter card then uses ports 9 to 12 on the base card for its trunk connections.</p> <p><b>Port LEDs</b></p> <p>LED use depends on the type of daughter card installed on the base card:</p> <ul style="list-style-type: none"> <li>• LED 9 is also used for daughter card status. <ul style="list-style-type: none"> <li>• <b>Red On</b> = Error</li> <li>• <b>Red Flash every 5 seconds</b> = Card okay.</li> <li>• <b>Red Slow Flash</b> = Initializing.</li> <li>• <b>Red Fast Flash</b> = System shutdown.</li> </ul> </li> </ul> <p><b>Analog Card</b></p> <ul style="list-style-type: none"> <li>• <b>Green on</b> = V1: Card installed. V2: Line connected to the port but idle.</li> <li>• <b>Green flashing</b> = Line in use.</li> </ul> <p><b>PRI Card</b></p> <ul style="list-style-type: none"> <li>• <b>Off</b> = No trunk present.</li> <li>• <b>Green on</b> = Trunk present.</li> <li>• <b>Green flashing</b> = Trunk in use.</li> <li>• <b>Red/Green Fast Flash</b> (port 9) or <b>Green Fast Flash</b> (port 10) = Alarm indication signal (AIS) from the trunk remote end.</li> <li>• <b>Red with Green Blink</b> (port 9) or <b>Green Blink</b> (port 10) = Port in loopback mode (set through IP Office System Monitor).</li> </ul> <p><b>BRI Card</b></p> <ul style="list-style-type: none"> <li>• <b>Off</b> = No trunk present.</li> <li>• <b>Green on</b> = Trunk present.</li> <li>• <b>Green flashing</b> = Trunk in use.</li> </ul>

Name	Description	SAP Code
<b>IPO 500 Extn Card Dgtl Sta 8</b>	IP Office 500 Extension Card Digital Station 8	700417330
<b>IPO IP500 Extn Card Dgtl Sta 8 TAA</b>	" <a href="#">Trade Agreements Act</a> <sup>[38b]</sup> compliant variant.	700501512



### 12.3.7 ETR6 Card

This card is used to add 6 [ETR](#)<sup>[39]</sup> phone extension ports to an IP500 V2 control unit. This card is only supported by IP500 V2 systems running in IP Office Basic Edition - PARTNER® Mode or IP Office Basic Edition (U-Law) modes.

It also includes 2 analog extension ports which are for emergency use only when the card is fitted with an analog trunk daughter card. A further 4 RJ45 ports (9 to 12) are provided for trunk connections when an IP500 trunk daughter card is fitted to this card.

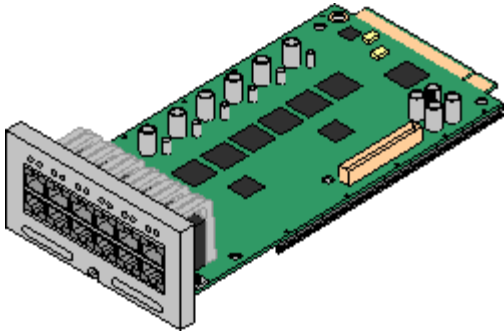

#### • Supports

[ETR](#)<sup>[39]</sup> and analog phones. Each ETR phone can be used for an ETR or analog phone. Support for ETR 34D phone is limited to a maximum of 2 per ETR6 card and 4 in total.

- Paging to external paging equipment is not supported via ETR6 ports. It is supported via POT ports.
- The only analog phones tested by Avaya for IP500 V2 are the Avaya 6200 Series. If other analog phones are used, it is the customer's own responsibility to ensure that those phones work as required.
- This card is only supported by IP500 V2 systems running in IP Office Basic Edition - PARTNER® Mode or IP Office Basic Edition (U-Law) modes. The card is not supported in other systems or if the system is changed to A-Law operation.

#### • Maximum per Control Unit: 3.

#### • IP500 Trunk Card Support: ✓ 1.

The IP500 BRI trunk daughter card is not supported.

Port Type	Ports	Features
ETR	1 to 6	<ul style="list-style-type: none"> <li>• REN 1.</li> <li>• DTMF dialing only.</li> <li>• Message waiting indication 51V stepped.</li> <li>• ICLID mode Bellcore 202.</li> </ul> <p><b>LEDs</b></p> <ul style="list-style-type: none"> <li>• No status LED are used for ETR ports.</li> <li>• LED1 is also used for base card status: <ul style="list-style-type: none"> <li>• <b>Red On</b> = Error</li> <li>• <b>Red Slow Flash</b> = Initializing.</li> <li>• <b>Red Flash every 5 seconds</b> = Card okay.</li> <li>• <b>Red Fast Flash</b> = System shutdown.</li> </ul> </li> </ul>
EF	7 to 8	<ul style="list-style-type: none"> <li>• If fitted with an IP500 Trunk Daughter card, during power failure both these ports are connected to analog trunk port 12.</li> <li>• Supports ICLID modes DTMFA, DTMFC, DTMFD, FSK and UK20.</li> <li>• REN 2 (1 for external bell device).</li> <li>• Off-Hook current: 25mA</li> <li>• Ring Voltage: 40V.</li> <li>• Intended for connection to two-wire analog phones, the ports do not include a ringing capacitor. For connection to 4-wire analog phones, connection should be via a master socket with ringing capacitors. <ul style="list-style-type: none"> <li>• No status LEDs are used for analog phone extensions.</li> </ul> </li> </ul>
Optional Trunk Ports	9 to 12	<p>Depends on the type of trunk daughter card fitted. The ETR6 can be fitted with either a <a href="#">Analog Trunk</a><sup>[21]</sup> card or <a href="#">PRI Trunk</a><sup>[21]</sup> card.</p> <p><b>LEDs</b></p> <p>LED use depends on the type of daughter card installed on the base card:</p> <ul style="list-style-type: none"> <li>• LED 9 is also used for daughter card status. <ul style="list-style-type: none"> <li>• <b>Red On</b> = Error</li> <li>• <b>Red Slow Flash</b> = Initializing.</li> <li>• <b>Red Flash every 5 seconds</b> = Card okay.</li> <li>• <b>Red Fast Flash</b> = System shutdown.</li> </ul> </li> </ul> <p><b>Analog Card</b></p> <ul style="list-style-type: none"> <li>• <b>Green on</b> = V1: Card installed. V2: Line connected to the port but idle.</li> <li>• <b>Green flashing</b> = Line in use.</li> </ul> <p><b>PRI Card</b></p> <ul style="list-style-type: none"> <li>• <b>Off</b> = No trunk present.</li> <li>• <b>Green on</b> = Trunk present.</li> <li>• <b>Green flashing</b> = Trunk in use.</li> <li>• <b>Red/Green Fast Flash</b> (port 9) or <b>Green Fast Flash</b> (port 10) = Alarm indication signal (AIS) from the trunk remote end.</li> <li>• <b>Red with Green Blink</b> (port 9) or <b>Green Blink</b> (port 10) = Port in loopback mode (set through IP Office System Monitor).</li> </ul>

---

Name	Description	SAP Code
IPO IP500 V2 EXTN CARD ETR6	IPO IP500 V2 EXTN CARD ETR6	700476039

### 12.3.8 TCM8 Digital Station

This card is used to add BST RJ45 extension ports to an IP500 V2 control unit. It provides 8 RJ45 extension ports for supported [Avaya BST digital telephones](#)<sup>[39]</sup>. A further 4 RJ45 ports are provided for trunk connections when an IP500 trunk card is fitted to this card.



- **Supports**  
Provides 8 BST ports for supported 4100, 7400, M and T-Series digital stations.
- **Maximum per Control Unit:** 4.
- **IP500 Trunk Card Support:** ✓ 1.

Port Type	Ports	Features
BST	1 to 8	<p><b>LEDs</b></p> <ul style="list-style-type: none"> <li>• <b>Green On</b> = Phone detected.</li> <li>• LED1 is also used for base card status: <ul style="list-style-type: none"> <li>• <b>Red On</b> = Error</li> <li>• <b>Red Slow Flash</b> = Initializing.</li> <li>• <b>Red Flash every 5 seconds</b> = Card okay.</li> <li>• <b>Red Fast Flash</b> = System shutdown.</li> </ul> </li> </ul>
Optional Trunk Card Ports	9 to 12	<p>The card can be fitted with one trunk daughter card of any type. The trunk daughter card then uses ports 9 to 12 on the base card for its trunk connections.</p> <p><b>LEDs</b></p> <p>LED use depends on the type of daughter card installed on the base card:</p> <ul style="list-style-type: none"> <li>• LED 9 is also used for daughter card status. <ul style="list-style-type: none"> <li>• <b>Red On</b> = Error</li> <li>• <b>Red Slow Flash</b> = Initializing.</li> <li>• <b>Red Flash every 5 seconds</b> = Card okay.</li> <li>• <b>Red Fast Flash</b> = System shutdown.</li> </ul> </li> </ul> <p><b>Analog Card</b></p> <ul style="list-style-type: none"> <li>• <b>Green on</b> = V1: Card installed. V2: Line connected to the port but idle.</li> <li>• <b>Green flashing</b> = Line in use.</li> </ul> <p><b>PRI Card</b></p> <ul style="list-style-type: none"> <li>• <b>Off</b> = No trunk present.</li> <li>• <b>Green on</b> = Trunk present.</li> <li>• <b>Green flashing</b> = Trunk in use.</li> <li>• <b>Red/Green Fast Flash</b> (port 9) or <b>Green Fast Flash</b> (port 10) = Alarm indication signal (AIS) from the trunk remote end.</li> <li>• <b>Red with Green Blink</b> (port 9) or <b>Green Blink</b> (port 10) = Port in loopback mode (set through IP Office System Monitor).</li> </ul> <p><b>BRI Card</b></p> <ul style="list-style-type: none"> <li>• <b>Off</b> = No trunk present.</li> <li>• <b>Green on</b> = Trunk present.</li> <li>• <b>Green flashing</b> = Trunk in use.</li> </ul>

Name	Description	SAP Code
IPO 500 TCM 8 Extn Card Assy	IP Office 500 TCM 8	700500758

## 12.3.9 VCM

This type of card is used to add voice compression channels to the control unit. Those channels are used for VoIP calls including IP extensions and or IP trunks.

IP500 V2 control units support up to 148 voice compression channels, using IP500 VCM cards and [IP500 Combination Cards](#)<sup>[203]</sup>.

The cards are available in 32 channel and 64 channel variants. All the card variants have 4 RJ45 ports which are used for trunk connections when an [IP500 trunk daughter card](#)<sup>[214]</sup> is fitted.

- **Avaya IP Endpoint License Support**

For systems running IP Office Release 6.0 or higher, each IP500 VCM 32 or IP500 VCM 64 card installed in the system enables 12 Avaya IP telephones without requiring any specific **Avaya IP Endpoint** licenses being added to the system configuration. This does not apply for IP500 VCM 32 V2 and IP500 VCM 64 V2 cards or for IP500 Combination cards. For further details refer to [Telephone/Endpoint Licenses](#)<sup>[372]</sup>.

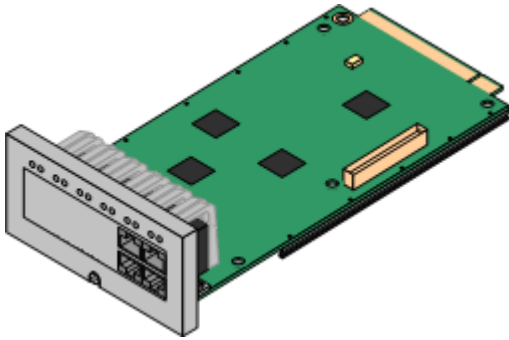

- **Supports**

Codecs G.711, G.729a and G.723 with 64ms echo cancellation. The maximum number of simultaneous channels useable on an IP500 VCM base card is affected by the codec being used. The following table assumes that all calls using the VCM use the same codec.

- G.722 is supported by IP Office Release 8.0 and higher in systems with an IP500 VCM card or an IP500 Combination card.

Codec	IP500 VCM 32 IP500 VCM 32 V2	IP500 VCM 64 IP500 VCM 64 V2
G.711	32	64
G.729a	30	60
G.723	22	44
G.722	30	60

- **Maximum per Control Unit:** 2.
- **IP500 Trunk Card Support:** ✓ 1.

Port Type	Ports	Features
Not present	1 to 8	<p>Not present.</p> <p><b>LEDs</b></p> <ul style="list-style-type: none"> <li>LEDs 1 to 8 are unlabelled. They are used to indicate voice compression channel usage. Each LED lit represents 12.5% of the available voice compression channel capacity in use (total card capacity rather than licensed capacity).</li> <li>LED1 is also used for base card status: <ul style="list-style-type: none"> <li><b>Red On</b> = Error</li> <li><b>Red Flash every 5 seconds</b> = Card okay.</li> <li><b>Red Slow Flash</b> = Initializing.</li> <li><b>Red Fast Flash</b> = System shutdown.</li> </ul> </li> </ul>
Optional Trunk Card Ports	9 to 12	<p>The card can be fitted with one trunk daughter card of any type. The trunk daughter card then uses ports 9 to 12 on the base card for its trunk connections.</p> <p><b>LEDs</b></p> <p>LED use depends on the type of daughter card installed on the base card:</p> <ul style="list-style-type: none"> <li>LED 9 is also used for daughter card status. <ul style="list-style-type: none"> <li><b>Red On</b> = Error</li> <li><b>Red Flash every 5 seconds</b> = Card okay.</li> <li><b>Red Slow Flash</b> = Initializing.</li> <li><b>Red Fast Flash</b> = System shutdown.</li> </ul> </li> </ul> <p><b>Analog Card</b></p> <ul style="list-style-type: none"> <li><b>Green on</b> = V1: Card installed. V2: Line connected to the port but idle.</li> <li><b>Green flashing</b> = Line in use.</li> </ul> <p><b>PRI Card</b></p> <ul style="list-style-type: none"> <li><b>Off</b> = No trunk present.</li> <li><b>Green on</b> = Trunk present.</li> <li><b>Green flashing</b> = Trunk in use.</li> <li><b>Red/Green Fast Flash</b> (port 9) or <b>Green Fast Flash</b> (port 10) = Alarm indication signal (AIS) from the trunk remote end.</li> <li><b>Red with Green Blink</b> (port 9) or <b>Green Blink</b> (port 10) = Port in loopback mode (set through IP Office System Monitor).</li> </ul> <p><b>BRI Card</b></p> <ul style="list-style-type: none"> <li><b>Off</b> = No trunk present.</li> <li><b>Green on</b> = Trunk present.</li> <li><b>Green flashing</b> = Trunk in use.</li> </ul>

	Name	Description	SAP Code
IP500 Voice Compression Modules	IPO IP500 MC VCM 32	IP Office 500 Media Card Voice Coding Module 32	700417389
	IPO IP500 VCM 32 TAA	" <a href="#">Trade Agreements Act</a> <sup>(388)</sup> compliant variant.	700501518
	IPO IP500 MC VCM 64	IP Office 500 Media Card Voice Coding Module 64	700417397
IP500 Voice Compression Modules V2	IPO IP500 MC VCM 32 V2	IP500 Media Card Voice Coding Module 32 V2	700504031
	IPO IP500 VCM 32 TAA V2	" <a href="#">Trade Agreements Act</a> <sup>(388)</sup> compliant variant.	700504033
	IPO IP500 MC VCM 64 V2	IP500 Media Card Voice Coding Module 64 V2	700504032

## 12.4 IP500 Trunk Daughter Cards

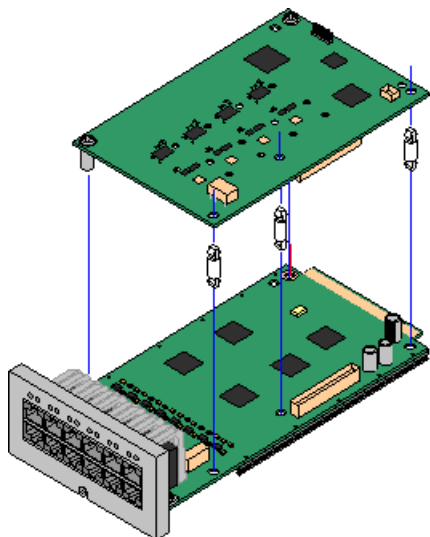

Many [IP500 base cards](#) <sup>[214]</sup> can be fitted with an IP500 trunk daughter cards to support the connection of trunks to the base card.

Each daughter card is supplied with the stand off pillars required for installation and a label to identify the daughter cards presence on the front of the base card after installation.

- IP500 Combination cards are pre-fitted with a trunk daughter card which cannot be removed or changed for another type/capacity trunk daughter card.

### [IP500 Analog Trunk Card/IP500 Analog Trunk Card V2](#) <sup>[215]</sup>

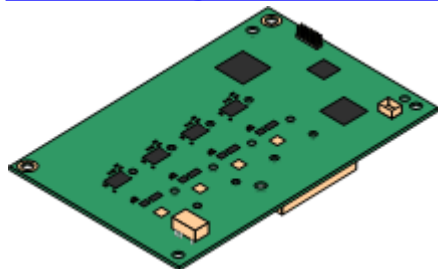

These cards allow the base card to support 4 analog loop-start trunks.

- The analog phone ports do not include a ringing capacitor. Where this is a requirement, connection should be via a Master socket containing ringing capacitors.
- If fitted with an IP500 Analog Trunk daughter card, during power failure phone port 8 is connected to analog trunk port 12.
- **Maximum:** 4 per control unit. The IP500 Analog Trunk Card V2 is only supported in the IP500 V2.

### [IP500 PRI-U Trunk Card](#) <sup>[216]</sup>

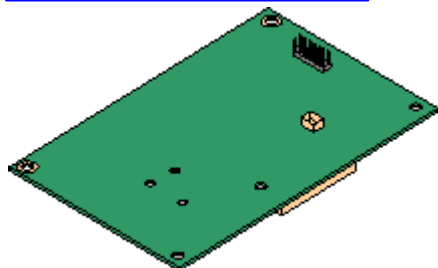

This card allows the base card to support up to 2 PRI trunk connections. The card is available in single and dual port variants. The card can be configured for E1 PRI, T1 robbed bit, T1 PRI or E1R2 PRI trunks. A T1(J) variant for use in Japan is also available.

- **Maximum:** 4 per control unit.
- The IP Office system supports 8 unlicensed B-channels on each IP500 PRI-U port fitted. Additional B-channels, up to the capacity of ports installed and PRI mode selected require [IP500 Universal PRI \(Additional Channels\)](#) <sup>[37]</sup> licenses added to the configuration. These additional channels consume the licenses based on which additional channels are configured as in-service from port 9 of slot 1 upwards. D-channels are not affected by licensing.

### [IP500 BRI Trunk Card](#) <sup>[217]</sup>

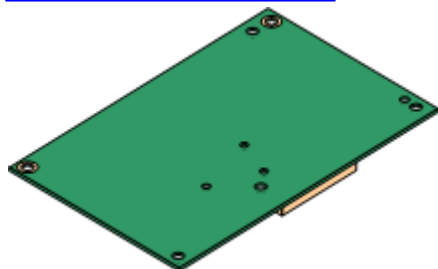

This card allows the base card to support up to 4 BRI trunk connections, each trunk providing 2B+D digital channels. The card is available in 2 port (4 channels) and 4 port (8 channels) variants.

- **Maximum:** 4 per control unit.
- **S-Bus Connection:** The card can be switched from To trunk mode to So mode. This mode requires additional terminating resistors and an ISDN crossover cable connection, see [BRI Port \(So\)](#) <sup>[35]</sup>.
- IP Office Basic Edition - Norstar Mode and IP Office Basic Edition systems are limited to a maximum of 12 BRI channels using BRI Combination and or BRI trunk daughter cards.

## 12.4.1 Analog Trunk Card

These cards can be added to an IP500 base card to provide that card with support for 4 loop-start analog trunks. The newer IP500 Analog Trunk Card V2 version is supported by IP500 V2 systems running IP Office Release 8.1 Feature Pack 1 or higher only.

This card can be fitted to any IP500 base card except the IP500 4-Port Expansion card.

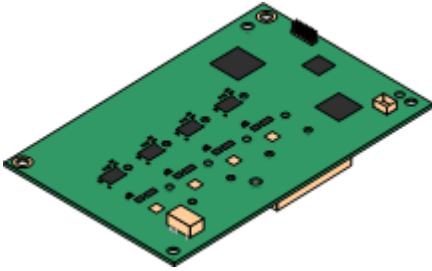

- **Ports/Channels**

4 Loop-start analog trunk ports. Connections via the host IP500 base card.

- DTMF, ICLID and busy tone detection.
- Over-voltage/lightning protection (may still require [additional protection equipment](#)<sup>[36]</sup>).
- DTMF and LD (loop disconnect) dialing.
- Echo cancellation.

- **Echo Cancellation**

The card supported echo cancellation that varies depending on the card type.

- **V1:** Echo cancellation manually selectable to either **8**, **16**, **32**, **64** or **128** milliseconds or **Off**. The default is 16 milliseconds.
- **V2:** Echo cancellation manually selectable to either **On** or **Off**. The default is **On**. The IP500 Analog Trunk Card V2 also supports echo reduction which is set to **On** by default.

- **Service Status/Line Status Indication**

- **V1:** Detection of individual line status for idle lines is not supported. Therefore, the card LEDs and System Status Application simply indicate that the card is installed and when the line is in use.
- **V2:** Automatic detection of line status for idle lines is supported. The card LEDs and System Status Application indicate that the individual line is connected and idle or is in use.

- **Impedance Matching**

- **V1:** For this card only manual impedance matching is useable and only in selected locales.
- **V2:** This card supports automatic impedance matching at system startup and this mode is enabled by default. Manual or no impedance matching can be used if required. Impedance matching is supported in all locales.

- **Voice Activity Detection (VAD)**

Support for ATM4U-V2 cards on IP Office Release 9.1 and higher only. When enabled, allows the support on analog trunks of functions that require call progress indication, for example the use of mobile twinning. The function is not enabled by default.

- **Power Failure Port**

Regardless of the IP500 card hosting it, during power failure pins 4 and 5 of port 12 are connected to pins 7 and 8. In addition, when fitted to an IP500 Analog Phone 8 base card, during power failure extension port 8 is connected to the analog trunk port 12.

- **License:** No license required.

- **Maximum per Control Unit:** 4.

- **IP Office Software Level:**

This depends on the version of the card as follow:

- **V1:** 4.0+.  
New build PCS10 and higher cards are only supported in systems running IP Office Release 6.1(20), 7.0(12) or 8.0 and higher. Refer to IP Office Technical Tip 237.
- **V2:** 8.1 Feature Pack 1+

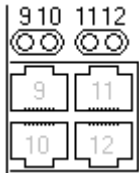

### Daughter Card Ports (9-12)

The LEDs for ports 9 to 12 of the IP500 base card are used as follows:

- **Green on** = V1: Card installed. V2: Line connected to the port but idle.
- **Green flashing** = Line in use.
- LED 9 is also used for daughter card status.
  - **Red On** = Error
  - **Red Slow Flash** = Initializing.
  - **Red Flash every 5 seconds** = Card okay.
  - **Red Fast Flash** = System shutdown.

Name	Description	SAP Code
<b>IPO 500 Trnk Anlg 4 Uni</b>	IP Office 500 Trunk Card Analog 4 Universal	700417405
<b>IPO IP500 Trunk Card Anlg 4 V2</b>	IP Office 500 Trunk Card Analog 4 Universal V2	700503164



## 12.4.2 BRI Trunk Cards

This card can be added to an IP500 base card to provide that card with support for [BRI-To](#)<sup>[358]</sup> trunks. The card is available in 8 channel (4 physical trunks) or 4 channel (2 physical trunks) variants.

This card can be fitted to any IP500 base card except the IP500 4-Port Expansion card.

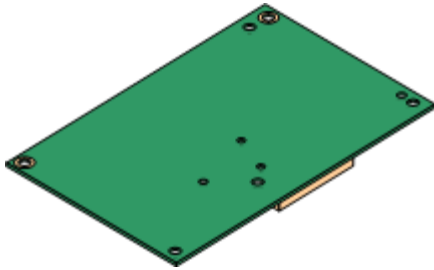

- **Ports/Channels**  
2 or 4 BRI trunk ports. Connections via ports 9 to 12 of the host IP500 base card.
- Each trunk port supports 2B+D channels.
- ETSI or AusTS013 basic rate protocol set through the IP Office configuration.
- **License:** No license required.
- **Maximum per Control Unit:** 4.
  - IP Office Basic Edition - Norstar Mode and IP Office Basic Edition systems are limited to a maximum of 12 BRI channels using BRI Combination and or BRI trunk daughter cards.
- **IP Office Software Level:** 4.0+.
- **S-Bus Connection:** On IP Office 4.2+ systems, the card can be switched from [To](#)<sup>[358]</sup> trunk mode to [So](#)<sup>[357]</sup> mode. This mode requires additional terminating resistors and an ISDN crossover cable connection, see [BRI Port \(So\)](#)<sup>[357]</sup>.
- This card is approved for use in the following countries:

Brazil.	New Zealand.
China.	Russia.
India.	South Africa.
Argentina.	United Arab Emirates (UAE).
Australia.	European Union (EU).

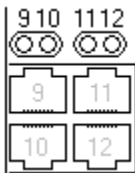

### Daughter Card Ports (9-12)

The LEDs for ports 9 to 12 of the IP500 base card are used as follows:

- **Off** = No trunk present.
- **Green on** = Trunk present.
- **Green flashing** = Trunk in use.
- LED 9 is also used for daughter card status.
  - **Red On** = Error
  - **Red Slow Flash** = Initializing.
  - **Red Flash every 5 seconds** = Card okay.
  - **Red Fast Flash** = System shutdown.

Name	Description	SAP Code
<b>IPO 500 Trnk BRI 4 Uni</b>	IP Office 500 Trunk Card Basic Rate 4 Universal	700417413
<b>IPO IP500 TRNK BRI 4 UNI TAA</b>	" <a href="#">Trade Agreements Act</a> <sup>[388]</sup> compliant variant.	700501515
<b>IPO 500 Trnk BRI 8 Uni</b>	IP Office 500 Trunk Card Basic Rate 8 Universal	700417421
<b>IPO IP500 BRI SO CONVTR CBL</b>	IP500 BRI So Converter Cable	700458649

## 12.4.3 PRI Trunk Cards

This card can be added to an IP500 base card to provide that card with support for PRI trunks. The card is available in single port or dual port variants.

This card can be fitted to any IP500 base card except the IP500 4-Port Expansion card.

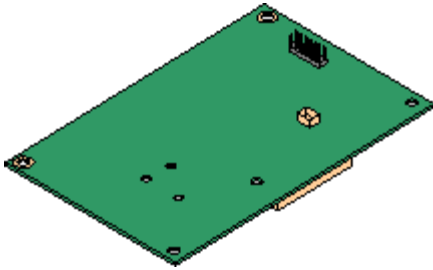

- **Ports/Channels**

1 or 2 [PRI trunk ports](#)<sup>[366]</sup>. Each port supports the following PRI line types. On dual port cards, both ports will be the same line type. The line type selection can be changed using IP Office Manager. The options available depend on the IP Office operation mode and locale.

- E1 PRI (30B+D channels per port).
- E1R2 PRI (30B channels per port).
- T1 robbed bit (24B channels per port) or T1 PRI (23B+D channels per port).
- A T1(J) variant for use in Japan is also available (9.1 Feature Pack and higher).
- The required mode can be selected within IP Office Manager by right-clicking on the line icon and selecting **Change Universal PRI Card Line Type** and then selecting the required line type.
- Physical trunk connection is via ports 9 and 10 of the host IP500 base card.
- Port 11 and 12 can be used as test points for connection of test and monitoring equipment for the adjacent port.

- **Licenses**

The IP Office system supports 8 unlicensed B-channels on each IP500 PRI-U port fitted. Additional B-channels, up to the capacity of ports installed and PRI mode selected require **IP500 Universal PRI (Additional Channels)** licenses added to the configuration. These additional channels consume the licenses based on which additional channels are configured as in-service from port 9 of slot 1 upwards. D-channels are not affected by licensing.

- **Maximum per Control Unit:** 4 per control unit in IP Office standard modes. 1 single port card only in other modes.
- **Software Level:** 4.1+.

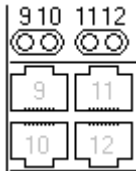

### Daughter Card Ports (9-12)

The LEDs for ports 9 to 12 of the IP500 base card are used as follows:

- **Off** = No trunk present.
- **Green on** = Trunk present.
- **Green flashing** = Trunk in use.
- **Red/Green Fast Flash** (port 9) or **Green Fast Flash** (port 10) = Alarm indication signal (AIS) from the trunk remote end.
- **Red with Green Blink** (port 9) or **Green Blink** (port 10) = Port in loopback mode (set through IP Office System Monitor).
- LED 9 is also used for daughter card status.
  - **Red On** = Error
  - **Red Slow Flash** = Initializing.
  - **Red Flash every 5 seconds** = Card okay.
  - **Red Fast Flash** = System shutdown.

Name	Description	SAP Code
IPO 500 TRNK PRI UNVRSL SNGL	IP Office 500 Trunk Card Primary Rate 1 Universal	700417439
IPO IP500 TRNK PRI UNVRSL SNGL TAA	" <a href="#">Trade Agreements Act</a> <sup>[388]</sup> compliant variant.	700501514
IPO 500 TRNK PRI UNVRSL DUAL	IP Office 500 Trunk Card Primary Rate 2 Universal	700417462
IPO IP500 TRNK PRI UNVSL DUAL TAA	" <a href="#">Trade Agreements Act</a> <sup>[388]</sup> compliant variant.	700501517
IPO IP500 Trunk CARD T1(J) PRI DUAL JAPAN	Dual T1(J) Interface Card	700509377

## 12.5 IP500 External Expansion Modules

The following IP500 external expansion modules are supported by IP Office Release 9.1. Each module uses an external [power supply unit](#)<sup>[30]</sup> supplied with the module. A locale specific [power cord](#)<sup>[31]</sup> for the PSU must be ordered separately.

The external module can be stacked on top of the control unit. They can also be wall or rack mounted using one of the [IP Office mounting kits](#)<sup>[24]</sup>.

- Systems running in IP Office Basic Edition modes support up to 8 external expansion modules so long as the system extensions limit is not exceeded.
- Systems running in IP Office standard modes support 8 external expansion modules or 12 if the control unit is fitted with an IP500 4-Port Expansion Base Card.

- **[IP500 Digital Station Module](#)**<sup>[225]</sup>

Provides, depending on variant, an additional 16 or 30 RJ45 [DS](#)<sup>[360]</sup> ports for supported [Avaya DS digital phones](#)<sup>[39]</sup>.

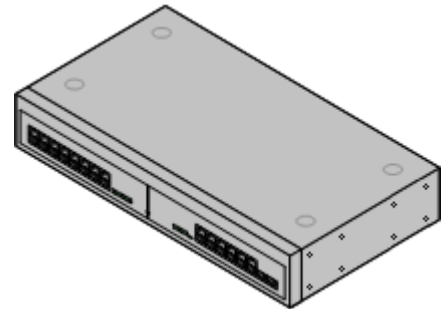

- **[IP500 Digital Station A Module](#)**<sup>[227]</sup>

Provides, depending on variant, RJ21 ports for connection of an additional 16 or 30 [Avaya BST digital phones](#)<sup>[39]</sup>. Supported by IP500 V2 only.

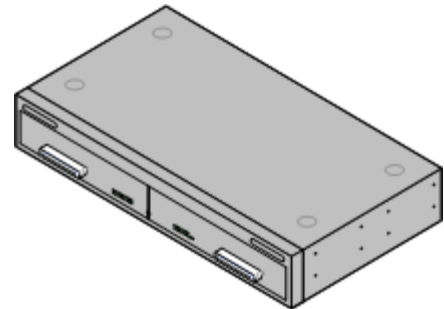

- **[IP500 Digital Station B Module](#)**<sup>[230]</sup>

Provides, depending on variant, an additional 16 or 30 RJ45 ports. These can be used as either [DS](#)<sup>[360]</sup> ports for supported [Avaya DS digital phones](#)<sup>[39]</sup> or [BST](#)<sup>[359]</sup> ports for supported [Avaya BST digital phones](#)<sup>[39]</sup>. However, the module can only support one port type at any time.

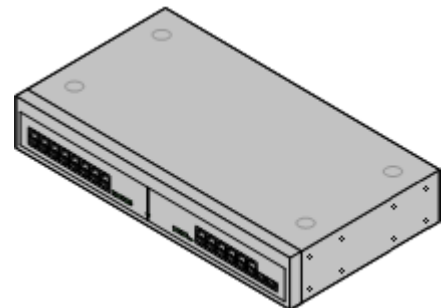

- **[IP500 Phone Module](#)**<sup>[232]</sup>

Provides, depending on variant, an additional 16 or 30 [PHONE](#)<sup>[365]</sup> ports for connecting analog phones.

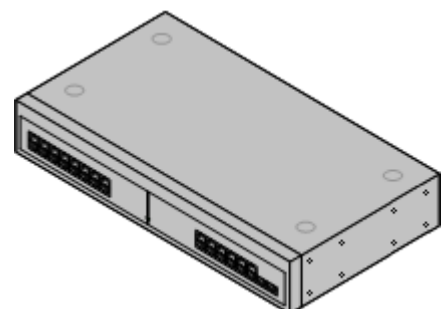

---

- **IP500 BRI So8 Module** <sup>[223]</sup>

Provides 8 ETSI [BRI-So ports](#) <sup>[357]</sup> for the connection of ISDN devices. This unit is not intended to support BRI trunks.

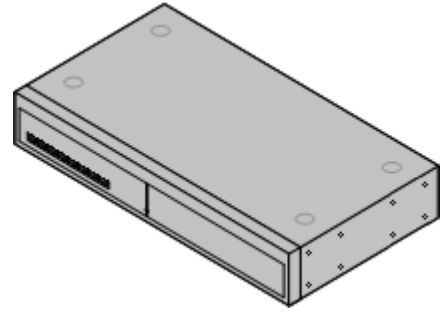

- **IP500 Analog Trunk Module** <sup>[221]</sup>

Provides an additional 16 [ANALOG](#) <sup>[356]</sup> ports for connection of analog trunks. Supports both loop-start and ground-start trunks.

- Use with ground start trunks requires that the trunk module and the IP Office control unit are grounded.
- In IP Office Basic Edition - PARTNER® Mode, IP Office Basic Edition - Norstar Mode and IP Office Basic Editions, only 1 Analog Trunk module is supported.

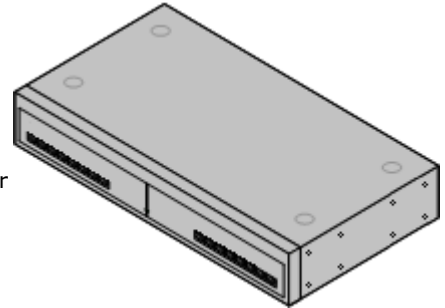

## 12.5.1 Analog Trunk 16

The IP500 Analog Trunk module can be used to add 16 additional analog trunks to an IP Office system. The module supports both loop-start and, with suitable grounding, ground-start trunks.

- In IP Office Basic Edition - PARTNER® Mode, IP Office Basic Edition - Norstar Mode and IP Office Basic Editions, only 1 Analog Trunk module is supported.
- **⚠ WARNING**  
In all IP Office installations, any module being used for analog trunk connections must be connected to a [functional earth](#) <sup>[35]</sup>.
- **⚠ WARNING**  
Within areas of high lightning risk, any module using analog trunk connections must be connected to a [protective ground](#) <sup>[35]</sup> and to [surge protection equipment](#) <sup>[36]</sup>.

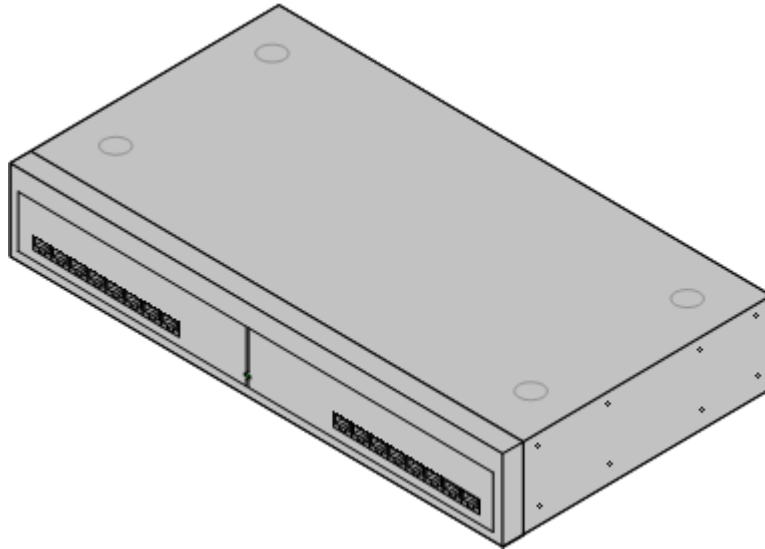

Feature	Details
<b>Locales</b>	This module is currently only supported in North American locales.
<b>Software Level</b>	IP Office core software level 1.0 minimum. Bin file = naatm16.bin.
<b>Included</b>	Power supply unit (see below) and Expansion Interconnect cable.
<b>Power Supply</b>	The module is supplied with a 2-pin, 40W external power supply unit. The PSU has an integral power cord for connection to the module's DC I/P socket. A locale specific <a href="#">IEC60320 C7 power cord</a> <sup>[30]</sup> for the external PSU is required but is not supplied with the module.
<b>Mounting</b>	The module is designed as a free-standing module that can be stacked on or under other IP Office modules. The module can be wall or rack mounted using the <a href="#">IPO IP500 RACK MNTG KIT V3</a> <sup>[24]</sup> .
<b>Dimensions</b>	Width: 445mm/17.5". Depth: 245mm/9.7". Height: 71mm/2.8"/2U.
<b>Weight</b>	Unboxed: 2.9Kg/6.6lbs. Boxed: 4.2Kg/9.4lbs.

### Module Front

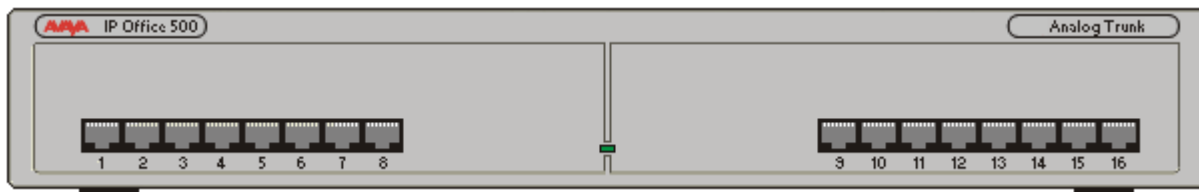

<b>Port LEDs</b>	None
<b>Module Center LED</b>	<p>The center LED on all external expansion modules is used to indicate the overall state of the module as follows:</p> <ul style="list-style-type: none"> <li>• <b>Red flashing</b> = Module starting up/Loading firmware.</li> <li>• <b>Red on</b> = Error.</li> <li>• <b>Green on</b> = Module okay.</li> </ul>

## Module Rear

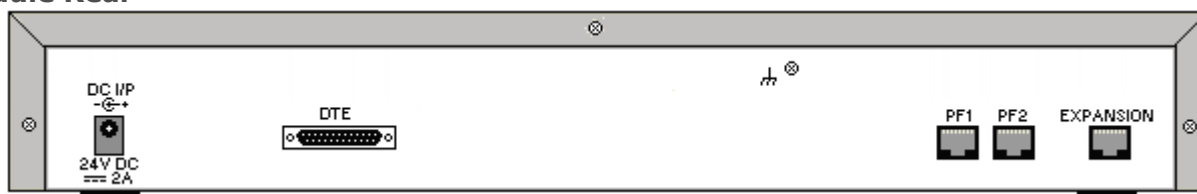

Ports	Description
<b>ANALOG</b> <sup>[356]</sup>	RJ45 socket. Used for connection to analog trunks. Ports can be configured as either loop-start or ground-start trunks through the IP Office configuration. In the event of power failure, Analog ports 1 and 2 are directly connected to analog extension ports PF1 and PF2 respectively. If used the connected phones must be clearly labeled as power failure devices. This is only supported for loop-start analog trunks.
<b>DC I/P</b> <sup>[366]</sup>	DC power input port. Used for connection of the power lead from an Avaya 40W external power supply unit supplied with the expansion module. A locale specific <a href="#">IEC60320 C7 power cord</a> <sup>[30]</sup> for the external PSU is required but is not supplied with the module.
<b>DTE</b> <sup>[367]</sup>	25-Way D-Type socket. For Avaya use only.
<b>EXPANSION</b> <sup>[362]</sup>	RJ45 Socket. Used for direct connection to an Expansion port on an IP Office control unit using the Expansion Interconnect cable supplied with the module.
<b>PF</b> <sup>[364]</sup>	RJ45 socket. Power failure analog extension ports. See Analog section above.
	Ground point. Used for connection of a <a href="#">functional earth</a> <sup>[35]</sup> if required. On older modules where this screw is not present, the top-center cover screw should be used instead. <ul style="list-style-type: none"> <li>• <b>IMPORTANT</b> In all IP Office installations, any module being used for analog trunk connections must be connected to a <a href="#">functional earth</a> <sup>[35]</sup>.</li> <li>• <b>WARNING</b> Within areas of high lightning risk, any module using analog trunk connections must be connected to a <a href="#">protective ground</a> <sup>[35]</sup> and to <a href="#">surge protection equipment</a> <sup>[36]</sup>.</li> </ul>

## Part Codes and Related Equipment

All expansion modules are supplied with a base software level and should be upgraded to match the core software of the control unit in the IP Office system. Expansion modules include an external power supply unit (PSU) and an appropriate interconnect cable. They do not include a locale specific power cord for the external PSU or any phone extension cables.

Item	Variant	Country	SAP Code
<b>IPO IP500 EXP MOD ANLG TRNK 16</b>	<b>America</b>	America	700449473
<b>IPO IP500 EXP MOD ANLG TRNK 16 TAA</b>	" <a href="#">Trade Agreements Act</a> <sup>[388]</sup> compliant variant.	America	700501511
<b>IEC60320 C7 Power Cord</b> 	<b>NEMA1-15</b>	America	700213390
<b>Mounting Kit</b>	<b>IPO IP500 RACK MNTG KIT V3</b>	All	700503160

## 12.5.2 BRI So8

The So8 module can be used to add ETSI BRI S0-interface ports to the IP Office system. These ports can then be used for the connection of ISDN devices.

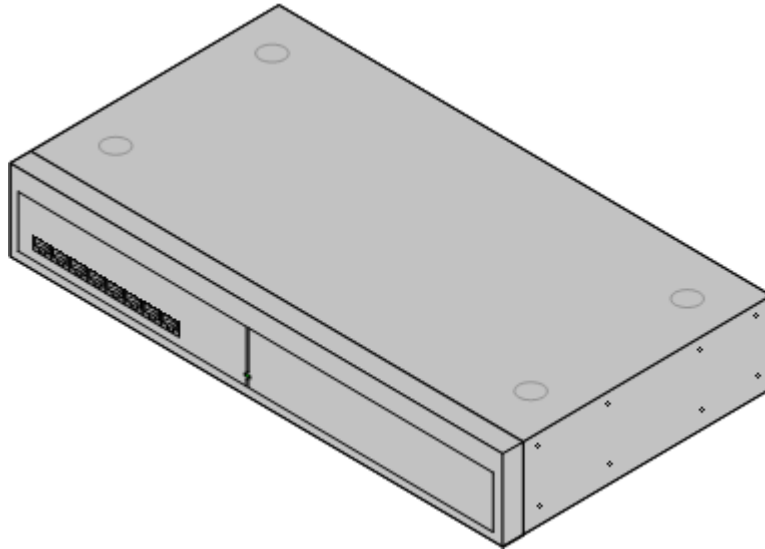

Feature	Details
<b>Locales</b>	Supported in all <a href="#">IP Office locales</a> <sup>[43]</sup> .
<b>Software Level</b>	IP Office core software level 1.0 minimum. Bin file = nas0-16.bin.
<b>Included</b>	Power supply unit (see below) and Expansion Interconnect cable.
<b>Power Supply</b>	The unit is supplied with an earthed 3-Pin, 60W external power supply unit. The PSU has an integral power cord for connection to the unit's DC I/P socket. A locale specific <a href="#">IEC60320 C13 power cord</a> <sup>[30]</sup> for the external PSU is required but is not supplied with the unit.
<b>Mounting</b>	The module is designed as a free-standing module that can be stacked on or under other IP Office modules. The module can be wall or rack mounted using the <a href="#">IPO IP500 RACK MNTG KIT V3</a> <sup>[24]</sup> .
<b>Dimensions</b>	Width: 445mm/17.5". Depth: 245mm/9.7". Height: 71mm/2.8"/2U.
<b>Weight</b>	Unboxed: 2.8Kg/6.3lbs. Boxed: 4.1Kg/9.2lbs.

### Module Front

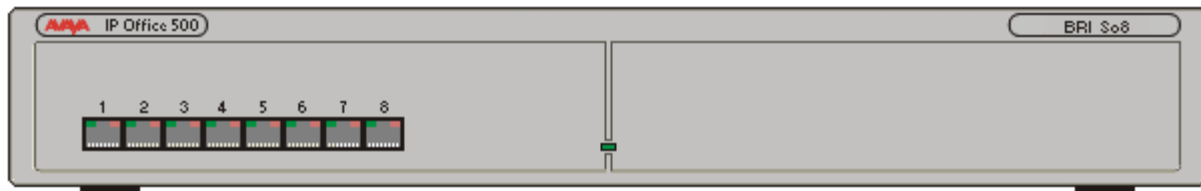

<b>Port LEDs</b>	<ul style="list-style-type: none"> <li>• <b>Green On</b> = Connected.</li> <li>• <b>Green Flashing</b> = Activity.</li> </ul>
<b>Module Center LED</b>	<p>The center LED on all external expansion modules is used to indicate the overall state of the module as follows:</p> <ul style="list-style-type: none"> <li>• <b>Red flashing</b> = Module starting up/Loading firmware.</li> <li>• <b>Red on</b> = Error.</li> <li>• <b>Green on</b> = Module okay.</li> </ul>

## Module Rear

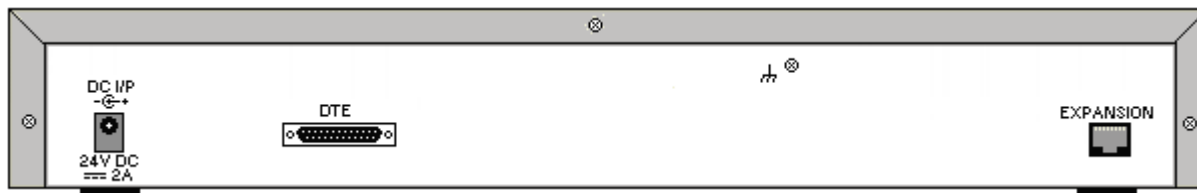

Ports	Description
<a href="#">BRI</a> <sup>[357]</sup>	RJ45 socket. Used for connection of ISDN terminal devices. Note: These ports appear a lines within the IP Office configuration. However they cannot be used for connection to external BRI lines.
<a href="#">DC I/P</a> <sup>[360]</sup>	DC power input port. Used for connection of the power lead from an Avaya 60W external power supply unit supplied with the expansion module. A locale specific <a href="#">IEC60320 C13 power cord</a> <sup>[30]</sup> for the external PSU is required but is not supplied with the module.
<a href="#">DTE</a> <sup>[367]</sup>	25-Way D-Type socket. For Avaya use only.
<a href="#">EXPANSION</a> <sup>[362]</sup>	RJ45 Socket. Used for direct connection to an Expansion port on an IP Office control unit using the Expansion Interconnect cable supplied with the module.
	Function ground point. Used for connection of a <a href="#">protective or functional</a> <sup>[35]</sup> ground if required. On older modules where this screw is not present, the top-center cover screw should be used instead.

## Part Codes and Related Equipment

All expansion modules are supplied with a base software level and should be upgraded to match the core software of the control unit in the IP Office system. Expansion modules include an external power supply unit (PSU) and an appropriate interconnect cable. They do not include a locale specific power cord for the external PSU or any phone extension cables.

Item	Variant	Country	SAP Code
<b>IPO 500 BRI So8</b>		All	700449515
 <b>IEC60320 C13 Power Cord</b>	<b>CEE7/7</b>	Europe	700289762
	<b>BS1363</b>	United Kingdom	700289747
	<b>NEMA5-15P</b>	America	700289770
<b>Mounting Kit</b>	<b>IPO IP500 RACK MNTG KIT V3</b>	All	700503160



### 12.5.3 Digital Station 16/30

IP Office 500 Digital Station modules can be used to add additional [DS ports](#)<sup>[360]</sup> to an IP Office system for support [Avaya DS digital telephones](#)<sup>[39]</sup>. The module is available in 16 and 30 port variants, referred to as the IP500 DS16 and IP500 DS30 respectively. These modules are also known as IP500 DS V2 modules. This module has been superseded by the [IP500 DS16B/30B](#)<sup>[230]</sup>.

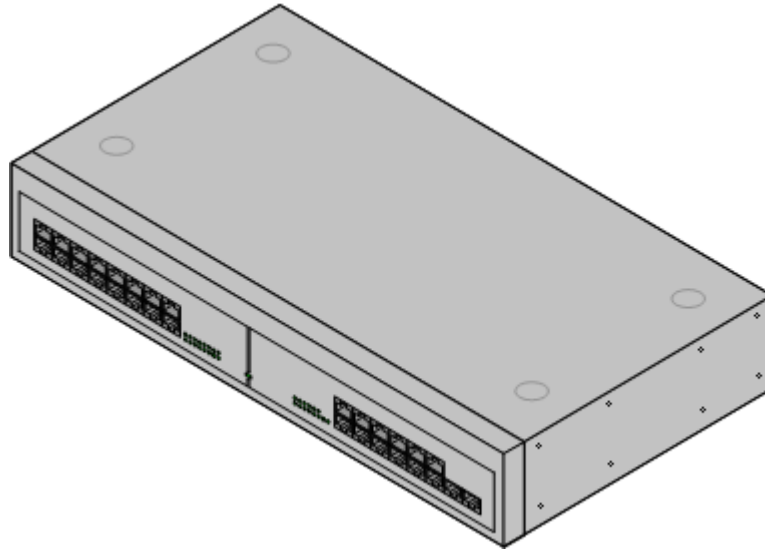

Feature	Details
<b>Locales</b>	Supported in all <a href="#">IP Office locales</a> <sup>[43]</sup> .
<b>Software Level</b>	IP Office core software level 2.1(31) minimum. Bin file = nadcpV2.bin.
<b>Included</b>	Power supply unit (see below) and Expansion Interconnect cable.
<b>Power Supply</b>	The module is supplied with a Earthed 3-Pin, 60W external power supply module. The PSU has an integral power cord for connection to the module's DC I/P socket. A locale specific <a href="#">IEC60320 C13 power cord</a> <sup>[30]</sup> for the external PSU is required but is not supplied with the module.
<b>Mounting</b>	The module is designed as a free-standing module that can be stacked on or under other IP Office modules. The module can be wall or rack mounted using the <a href="#">IPO IP500 RACK MNTG KIT V3</a> <sup>[24]</sup> .
<b>Dimensions</b>	Width: 445mm/17.5". Depth: 245mm/9.7". Height: 71mm/2.8".
<b>Weight</b>	Unboxed: 3.5Kg/7.8lbs. Boxed: 4.8Kg/10.8lbs. (Based on DS30)

#### Module Front

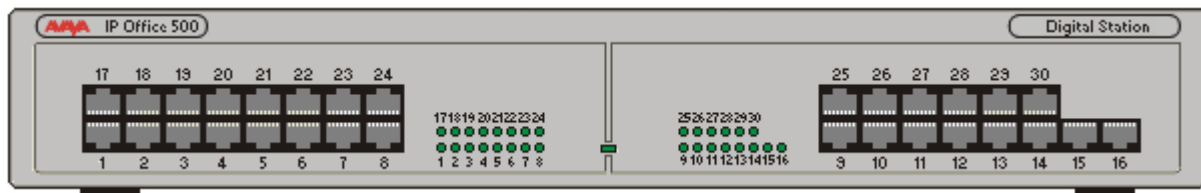

<b>Port LEDs</b>	<ul style="list-style-type: none"> <li>• <b>Green Flashing</b> = Phone detected.</li> <li>• <b>Green On</b> = Phone active.</li> </ul>
<b>Module Center LED</b>	<p>The center LED on all external expansion modules is used to indicate the overall state of the module as follows:</p> <ul style="list-style-type: none"> <li>• <b>Red flashing</b> = Module starting up/Loading firmware.</li> <li>• <b>Red on</b> = Error.</li> <li>• <b>Green on</b> = Module okay.</li> </ul>

## Module Rear

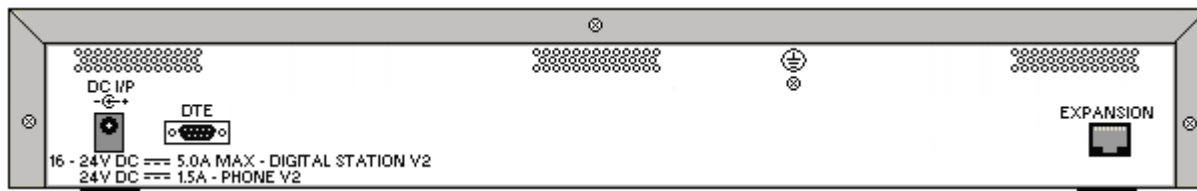

Port	Description
<a href="#">DC I/P</a> <sup>[360]</sup>	DC power input port. Used for connection of the power lead from an Avaya earthed 60W external power supply unit supplied with the expansion module. A locale specific <a href="#">IEC60320 C13 power cord</a> <sup>[30]</sup> for the external PSU is required but is not supplied with the module.
<a href="#">DS</a> <sup>[360]</sup>	RJ45 socket. Digital Station port. Used for connection of IP Office <a href="#">supported DS phones</a> <sup>[39]</sup> . If connected to an <a href="#">out-of-building extension</a> <sup>[36]</sup> , the connection must be made via additional IROB barrier devices in addition to the buildings primary protection. The module must also be connected to a protective ground.
<a href="#">DTE</a> <sup>[367]</sup>	9-Way D-Type socket. For Avaya use only.
<a href="#">EXPANSION</a> <sup>[362]</sup>	RJ45 Socket. Used for direct connection to an Expansion port on an IP Office control unit using the Expansion Interconnect cable supplied with the module.
	Protective Ground point. Use of a protective ground is required for all installations, see <a href="#">Grounding (Earthing)</a> <sup>[90]</sup> . Where the module is connected to analog extensions in another building, an IP Office Phone Barrier Box V2 (101V) is required at both ends, see <a href="#">Lightning Protection/Out-of-Building Connections</a> <sup>[36]</sup> .

## Part Codes and Related Equipment

All expansion modules are supplied with a base software level and should be upgraded to match the core software of the control unit in the IP Office system. Expansion modules include an external power supply unit (PSU) and an appropriate interconnect cable. They do not include a locale specific power cord for the external PSU or any phone extension cables.

Item	Variant	Country	SAP Code
<b>IPO IP500 EXP MOD DGTL STA 16</b>	<b>16 Ports</b>	All	700449499
<b>IPO IP500 EXP MOD DGTL STA 16 TAA</b>	" <a href="#">Trade Agreements Act</a> <sup>[388]</sup> compliant variant.		-
<b>IPO IP500 EXP MOD DGTL STA 30</b>	<b>30 Ports</b>		700426216
 <b>IEC60320 C13 Power Cord</b>	<b>CEE7/7</b>	Europe	700289762
	<b>BS1363</b>	United Kingdom	700289747
	<b>NEMA5-15P</b>	America	700289770
<b>Mounting Kit</b>	<b>IPO IP500 RACK MNTG KIT V3</b>	All	700503160

## 12.5.4 Digital Station 16A/30A

These modules can be used to add additional [BST ports](#)<sup>[359]</sup> for supported [Avaya BST digital telephones](#)<sup>[39]</sup>. The module is available in 16 and 30 port variants, referred to as the IP500 DS16A and IP500 DS30A respectively.

The modules use RJ21 connectors; 1 on the 16 port version, 2 on the 30 port version. For BST connections using RJ45 port, use the [IP500 DS16B/30B modules](#)<sup>[230]</sup>.

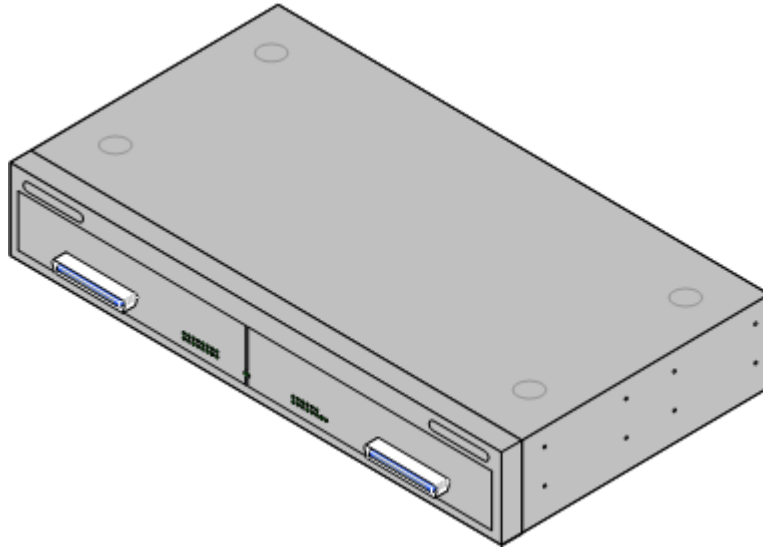

Feature	Details
<b>Locales</b>	Supported in all <a href="#">IP Office locales</a> <sup>[43]</sup> .
<b>Software Level</b>	IP Office Release 7.0 minimum (BST only). Bin file = nadcpav1.bin.
<b>Included</b>	Power supply unit (see below) and Expansion Interconnect cable.
<b>Power Supply</b>	The module is supplied with a Earthed 3-Pin, 60W external power supply module. The PSU has an integral power cord for connection to the module's DC I/P socket. A locale specific <a href="#">IEC60320 C13 power cord</a> <sup>[30]</sup> for the external PSU is required but is not supplied with the module.
<b>Mounting</b>	The module is designed as a free-standing module that can be stacked on or under other IP Office modules. The module can be wall or rack mounted using the <a href="#">IPO IP500 RACK MNTG KIT V3</a> <sup>[24]</sup> .
<b>Dimensions</b>	Width: 445mm/17.5". Depth: 245mm/9.7". Height: 71mm/2.8".
<b>Weight</b>	Unboxed: 3.5Kg/7.8lbs. Boxed: 4.8Kg/10.8lbs. (Based on DS30A RJ21)

### Module Front

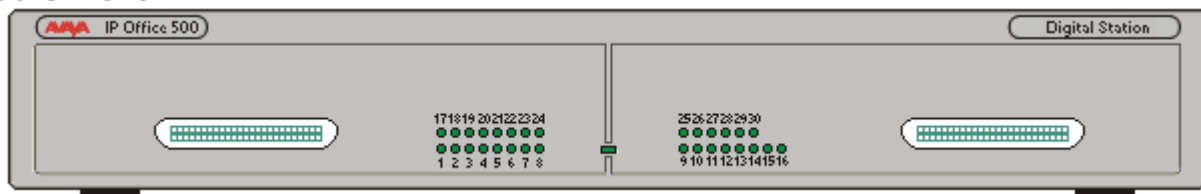

<b>Port LEDs</b>	<ul style="list-style-type: none"> <li>• <b>Green On</b> = Phone detected.</li> </ul>
<b>Module Center LED</b>	<p>The center LED on all external expansion modules is used to indicate the overall state of the module as follows:</p> <ul style="list-style-type: none"> <li>• <b>Red flashing</b> = Module starting up/Loading firmware.</li> <li>• <b>Red on</b> = Error.</li> <li>• <b>Green on</b> = Module okay.</li> <li>• <b>Green flashing</b> = Module starting up/Loading firmware (IP500 DS16A/30A module only).</li> </ul>

## Module Rear

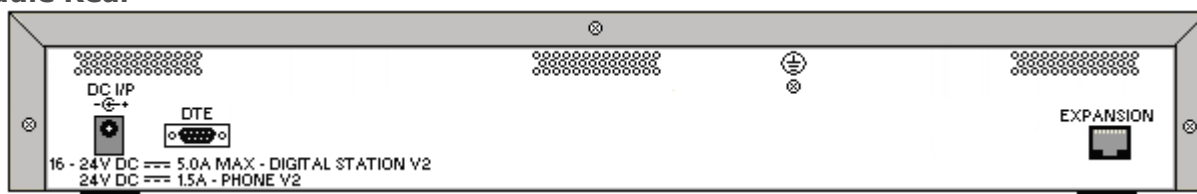

Ports	Description
<a href="#">DC I/P</a> <sup>[360]</sup>	DC power input port. Used for connection of the power lead from an Avaya earthed 60W external power supply unit supplied with the expansion module. A locale specific <a href="#">IEC60320 C13 power cord</a> <sup>[30]</sup> for the external PSU is required but is not supplied with the module.
<a href="#">RJ21</a> <sup>[359]</sup>	For IP Office Release 7.0, the modules support just phones requiring <a href="#">BST ports</a> <sup>[359]</sup> .
<a href="#">DTE</a> <sup>[367]</sup>	9-Way D-Type socket. For Avaya use only.
<a href="#">EXPANSION</a> <sup>[362]</sup>	RJ45 Socket. Used for direct connection to an Expansion port on an IP Office control unit using the Expansion Interconnect cable supplied with the module.
	Protective Ground point. Use of a protective ground is required for all installations, see <a href="#">Grounding (Earthing)</a> <sup>[90]</sup> . Where the module is connected to analog extensions in another building, an IP Office Phone Barrier Box V2 (101V) is required at both ends, see <a href="#">Lightning Protection/Out-of-Building Connections</a> <sup>[36]</sup> .

## Part Codes and Related Equipment

All expansion modules are supplied with a base software level and should be upgraded to match the core software of the control unit in the IP Office system. Expansion modules include an external power supply unit (PSU) and an appropriate interconnect cable. They do not include a locale specific power cord for the external PSU or any phone extension cables.

Item	Variant	Country	SAP Code
<b>IPO 500 Digital Station 16A RJ21 UNIT ASSY</b>	<b>RJ21</b>	All	700500699
<b>IPO 500 Digital Station 30A RJ21 UNIT ASSY</b>	<b>RJ21</b>		700500698
 <b>IEC60320 C13 Power Cord</b>	<b>CEE7/7</b>	Europe	700289762
	<b>BS1363</b>	United Kingdom	700289747
	<b>NEMA5-15P</b>	North America	700289770
<b>Mounting Kit</b>	<b>IPO IP500 RACK MNTG KIT V3</b>	All	700503160

**RJ21 Cable Pin Out**

The following pin-out is used for the RJ21 ports.

**1st RJ21 Connector**

Port		Pin	Wire
<b>1</b>	Tip	26	White/Blue
	Ring	1	Blue/White
<b>2</b>	Tip	27	White/Orange
	Ring	2	Orange/White
<b>3</b>	Tip	28	White/Green
	Ring	3	Green/White
<b>4</b>	Tip	29	White/Brown
	Ring	4	Brown/White
<b>5</b>	Tip	30	White/Slate
	Ring	5	Slate/White
<b>6</b>	Tip	31	Red/Blue
	Ring	6	Blue/Red
<b>7</b>	Tip	32	Red/Orange
	Ring	7	Orange/Red
<b>8</b>	Tip	33	Red/Green
	Ring	8	Green/Red
<b>9</b>	Tip	34	Red/Brown
	Ring	9	Brown/Red
<b>10</b>	Tip	35	Red/Slate
	Ring	10	Slate/Red
<b>11</b>	Tip	36	Black/Blue
	Ring	11	Blue/Black
<b>12</b>	Tip	37	Black/Orange
	Ring	12	Orange/Black
<b>13</b>	Tip	38	Black/Green
	Ring	13	Green/Black
<b>14</b>	Tip	39	Black/Brown
	Ring	14	Brown/Black
<b>15</b>	Tip	40	Black/Slate
	Ring	15	Slate/Black
<b>16</b>	Tip	41	Yellow/Blue
	Ring	16	Blue/Yellow
Not Used		42	Yellow/Orange
		17	Orange/Yellow
		43	Violet/Slate
		08	Slate/Violet

**2nd RJ21 Connector**

Port		Pin	Wire
<b>1</b>	Tip	26	White/Blue
	Ring	1	Blue/White
<b>2</b>	Tip	27	White/Orange
	Ring	2	Orange/White
<b>3</b>	Tip	28	White/Green
	Ring	3	Green/White
<b>4</b>	Tip	29	White/Brown
	Ring	4	Brown/White
<b>5</b>	Tip	30	White/Slate
	Ring	5	Slate/White
<b>6</b>	Tip	31	Red/Blue
	Ring	6	Blue/Red
<b>7</b>	Tip	32	Red/Orange
	Ring	7	Orange/Red
<b>8</b>	Tip	33	Red/Green
	Ring	8	Green/Red
<b>9</b>	Tip	34	Red/Brown
	Ring	9	Brown/Red
<b>10</b>	Tip	35	Red/Slate
	Ring	10	Slate/Red
<b>11</b>	Tip	36	Black/Blue
	Ring	11	Blue/Black
<b>12</b>	Tip	37	Black/Orange
	Ring	12	Orange/Black
<b>13</b>	Tip	38	Black/Green
	Ring	13	Green/Black
<b>14</b>	Tip	39	Black/Brown
	Ring	14	Brown/Black
Not Used		40	Black/Slate
		15	Slate/Black
		41	Yellow/Blue
		16	Blue/Yellow
		42	Yellow/Orange
		17	Orange/Yellow
		43	Violet/Slate
		08	Slate/Violet

## 12.5.5 Digital Station 16B/30B

This type of module can be used to add additional RJ45 ports for digital telephones. Through the system configuration, each module is set to either [DS](#) mode for support [Avaya DS digital telephones](#) or [BST](#) mode ports for supported [Avaya BST digital telephones](#) (DS ports only on IP500 control units). See [DS16B/30B Port Mode Selection](#).

The modules are available in 16 and 30 port variants, referred to as the IP500 DS16B and IP500 DS30B respectively.

- These modules only support the following DS phones: 1400 Series, 2400 Series, 3800 Series, 4400 Series, 5400 Series and 9500 Series.

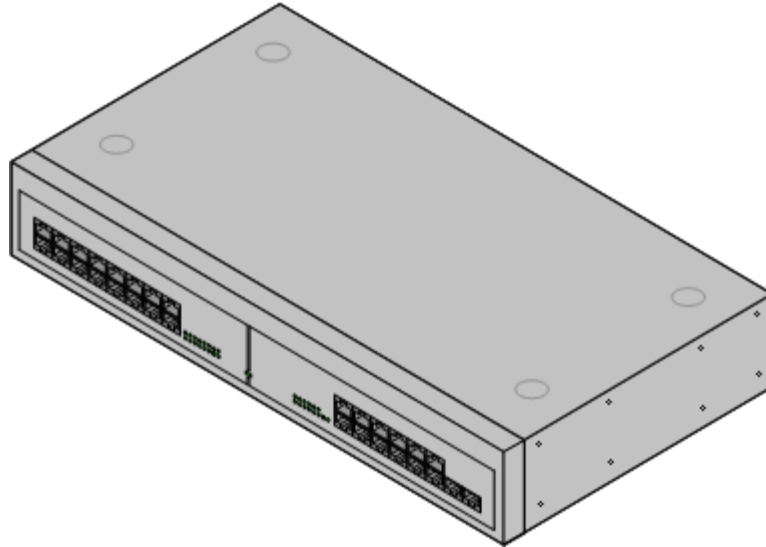

Feature	Details
<b>Locales</b>	Supported in all <a href="#">IP Office locales</a> .
<b>Software Level</b>	IP Office Release 9.0. IP500 (DS only) and IP500 V2 (DS or TCM). For IP Office Release 8.1 Service Pack 9 and higher these modules support DS ports only.
<b>Included</b>	Power supply unit (see below) and Expansion Interconnect cable.
<b>Power Supply</b>	The module is supplied with a Earthed 3-Pin, 60W external power supply module. The PSU has an integral power cord for connection to the module's DC I/P socket. A locale specific <a href="#">IEC60320 C13 power cord</a> for the external PSU is required but is not supplied with the module.
<b>Mounting</b>	The module is designed as a free-standing module that can be stacked on or under other IP Office modules. The module can be wall or rack mounted using the <a href="#">IPO IP500 RACK MNTG KIT V3</a> .
<b>Dimensions</b>	Width: 445mm/17.5". Depth: 245mm/9.7". Height: 71mm/2.8".
<b>Weight</b>	Unboxed: 3.5Kg/7.8lbs. Boxed: 4.8Kg/10.8lbs. (Based on DS30)

### Module Front

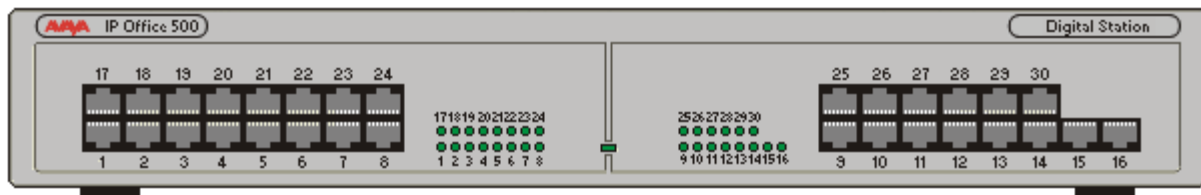

<b>Port LEDs</b>	<ul style="list-style-type: none"> <li>• <b>Green Flashing</b> = Phone detected.</li> <li>• <b>Green On</b> = Phone active.</li> </ul>
<b>Module Center LED</b>	<p>The center LED on all external expansion modules is used to indicate the overall state of the module as follows:</p> <ul style="list-style-type: none"> <li>• <b>Red flashing</b> = Module starting up/Loading firmware.</li> <li>• <b>Red on</b> = Error.</li> <li>• <b>Green on</b> = Module okay.</li> </ul>

## Module Rear

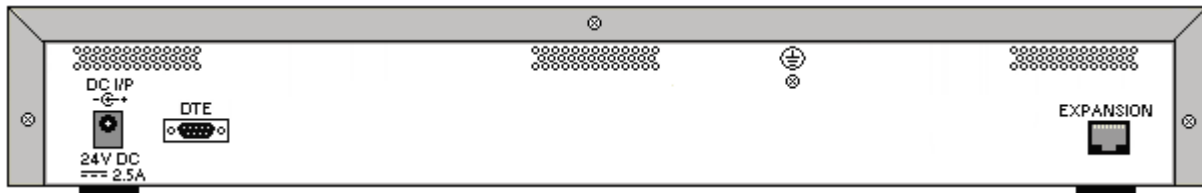

Port	Description
<a href="#">DC I/P</a> <sup>[360]</sup>	DC power input port. Used for connection of the power lead from an Avaya earthed 60W external power supply unit supplied with the expansion module. A locale specific <a href="#">IEC60320 C13 power cord</a> <sup>[30]</sup> for the external PSU is required but is not supplied with the module.
<a href="#">DS</a> <sup>[360]</sup>	RJ45 socket. Digital Station port. Used for connection of IP Office <a href="#">supported DS phones</a> <sup>[39]</sup> . If connected to an <a href="#">out-of-building extension</a> <sup>[36]</sup> , the connection must be made via additional IROB barrier devices in addition to the buildings primary protection. The module must also be connected to a protective ground.
<a href="#">DTE</a> <sup>[367]</sup>	9-Way D-Type socket. For Avaya use only.
<a href="#">EXPANSION</a> <sup>[362]</sup>	RJ45 Socket. Used for direct connection to an Expansion port on an IP Office control unit using the Expansion Interconnect cable supplied with the module.
	Protective Ground point. Use of a protective ground is required for all installations, see <a href="#">Grounding (Earthing)</a> <sup>[90]</sup> . Where the module is connected to analog extensions in another building, an IP Office Phone Barrier Box V2 (101V) is required at both ends, see <a href="#">Lightning Protection/Out-of-Building Connections</a> <sup>[36]</sup> .

## Part Codes and Related Equipment

All expansion modules are supplied with a base software level and should be upgraded to match the core software of the control unit in the IP Office system. Expansion modules include an external power supply unit (PSU) and an appropriate interconnect cable. They do not include a locale specific power cord for the external PSU or any phone extension cables.

Item	Variant	Country	SAP Code
<b>IPO IP500 EXP MOD DGTL STA 16</b>	<b>16 Ports</b>	All	700501585
<b>IPO IP500 EXP MOD DGTL STA 30</b>	<b>30 Ports</b>	All	700501586
 <b>IEC60320 C13 Power Cord</b>	<b>CEE7/7</b>	Europe	700289762
	<b>BS1363</b>	United Kingdom	700289747
	<b>NEMA5-15P</b>	America	700289770
<b>Mounting Kit</b>	<b>IPO IP500 RACK MNTG KIT V3</b>	All	700503160

## 12.5.6 Phone 16/30

IP500 Phone modules can be used to add additional PHONE ports to an IP Office system.

The module is available in 16 and 30 port variants, referred to as the IP500 Phone 16 and IP500 Phone 30 respectively.

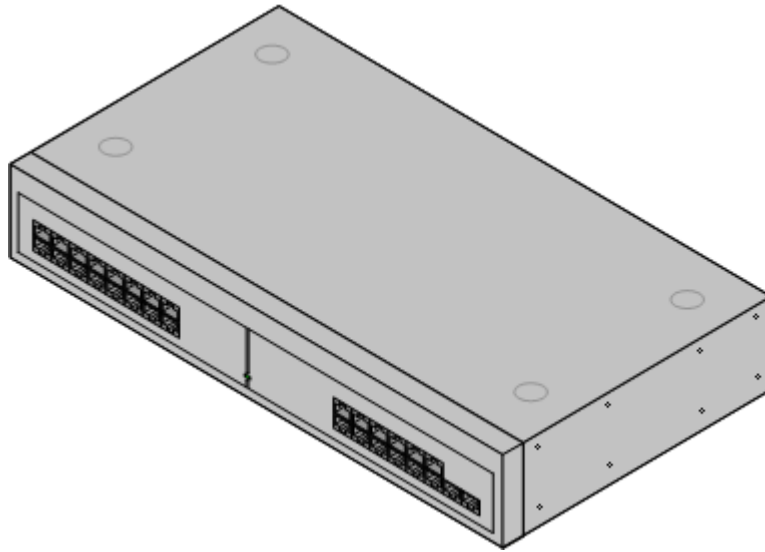

Feature	Details
<b>Locales</b>	Supported in all <a href="#">IP Office locales</a> <sup>[43]</sup> .
<b>Software Level</b>	IP Office core software level 2.1(36) minimum. Bin file = dvpots.bin.
<b>Included</b>	Power supply unit (see below) and Expansion Interconnect cable.
<b>Power Supply</b>	The module is supplied with a Earthed 3-Pin, 60W external power supply unit. The PSU has an integral power cord for connection to the module's DC I/P socket. A locale specific <a href="#">IEC60320 C13 power cord</a> <sup>[30]</sup> for the external PSU is required but is not supplied with the module.
<b>Mounting</b>	The module is designed as a free-standing module that can be stacked on or under other IP Office modules. The module can be wall or rack mounted using the <a href="#">IPO IP500 RACK MNTG KIT V3</a> <sup>[24]</sup> .
<b>Dimensions</b>	Width: 445mm/17.5". Depth: 245mm/9.7". Height: 71mm/2.8".
<b>Weight</b>	Unboxed: 3.1Kg/6.94lbs. Boxed: 4.4Kg/9.7lbs. (Based on Phone 30 V2)

### Module Front

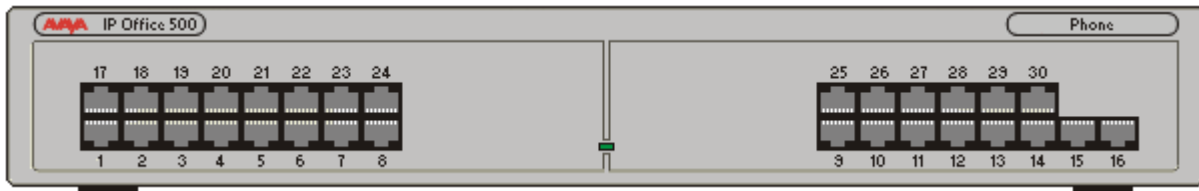

<b>Module Center LED</b>	<p>The center LED on all external expansion modules is used to indicate the overall state of the module as follows:</p> <ul style="list-style-type: none"> <li>• <b>Red flashing</b> = Module starting up/Loading firmware.</li> <li>• <b>Red on</b> = Error.</li> <li>• <b>Green on</b> = Module okay.</li> <li>• <b>Green flashing</b> = Module starting up/Loading firmware (IP500 DS16A/30A module only).</li> </ul>
--------------------------	--



## Module Rear

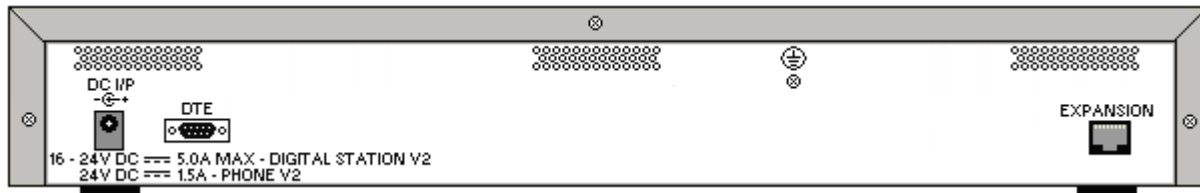

Ports	Description
<a href="#">DC I/P</a> <sup>[366]</sup>	DC power input port. Used for connection of the power lead from an Avaya earthed 60W external power supply unit supplied with the expansion module. A locale specific <a href="#">IEC60320 C13 power cord</a> <sup>[30]</sup> for the external PSU is required but is not supplied with the module.
<a href="#">DTE</a> <sup>[367]</sup>	9-Way D-Type socket. For Avaya use only.
<a href="#">EXPANSION</a> <sup>[362]</sup>	RJ45 Socket. Used for direct connection to an Expansion port on an IP Office control unit using the Expansion Interconnect cable supplied with the module.
<a href="#">PHONE</a> <sup>[365]</sup>	RJ45 socket. Used for connection of analog phones. Intended for two-wire analog phones. For connection to 4-wire analog phones connection should be via a master socket with ringing capacitors. If connected to an <a href="#">out-of-building extension</a> <sup>[368]</sup> , the connection must be made via additional <a href="#">IP Office Barrier Boxes</a> <sup>[174]</sup> in addition to the buildings primary protection. The module must also be connected to a protective ground.
	Protective Ground point. Use of a protective ground is required for all installations, see <a href="#">Grounding (Earthing)</a> <sup>[35]</sup> . Where the module is connected to analog extensions in another building, an IP Office Phone Barrier Box V2 (101V) is required at both ends, see <a href="#">Lightning Protection/Out-of-Building Connections</a> <sup>[36]</sup> .

## Part Codes and Related Equipment

All expansion modules are supplied with a base software level and should be upgraded to match the core software of the control unit in the IP Office system. Expansion modules include an external power supply unit (PSU) and an appropriate interconnect cable. They do not include a locale specific power cord for the external PSU or any phone extension cables.

Item	Variant	Country	SAP Code
<b>IPO IP500 EXP MOD PHONE 16</b>	<b>16 Ports</b>	All	700449507
<b>IPO IP500 EXP MOD PHONE 30</b>	<b>30 Ports</b>	All	700426224
	<b>CEE7/7</b>	Europe	700289762
	<b>BS1363</b>	United Kingdom	700289747
	<b>NEMA5-15P</b>	America	700289770
<b>Mounting Kit</b>	<b>IPO IP500 RACK MNTG KIT V3</b>	All	700503160
<b>IPO PHONE BARRIER BOX (101V) RHS</b>		All	700385495

## 12.6 IP400 Expansion Modules

The following IP400 external expansion modules are supported by IP Office Release 9.1 and can be used with IP500 V2 control units. Each module uses an external [power supply unit](#) <sup>[30]</sup> supplied with the module. A locale specific [power cord](#) <sup>[31]</sup> for the PSU must be ordered separately.

If being rack mounted these units use the IP400 rack mounting kit. If being rack mounted, these units use the IPO IP500 RACK MNTG KIT. They cannot be wall mounted.

- **IP400 Analog Trunk Module (ATM16)** <sup>[23]</sup>  
Provides an additional 16 [ANALOG](#) <sup>[35]</sup> ports for connection of analog trunks. Supports both loop-start and ground-start trunks.
  - Available in a number of variants for different locales.
  - Use with ground start trunks requires that the trunk module and the IP Office control unit are grounded.

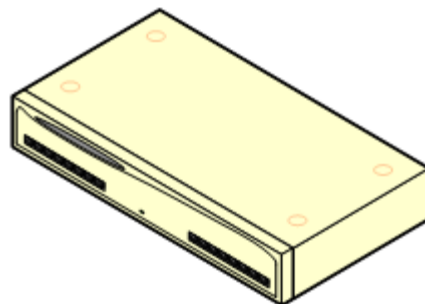

- **IP400 Digital Station Module V2** <sup>[23]</sup>  
Provides, depending on variant, an additional 16 or 30 [DS](#) <sup>[36]</sup> ports for supported [Avaya digital phones](#) <sup>[39]</sup>. Supersedes the previous Digital Station module.

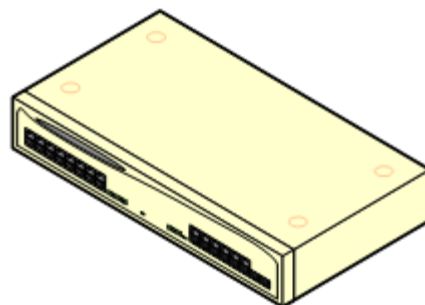

- **IP400 Phone Module V2** <sup>[23]</sup>  
Provides, depending on variant, an additional 8, 16 or 30 [PHONE](#) <sup>[36]</sup> ports for analog phones. Supersedes the previous Phone module. With IP Office 3.1, the Phone V2 supports a wider range of message waiting indication (MWI) options than Phone V1 modules.

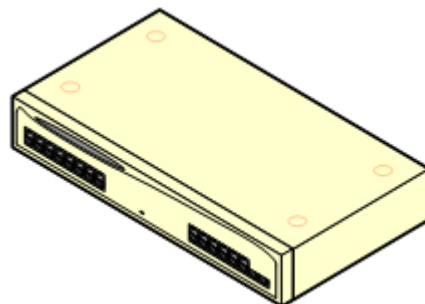

## 12.6.1 Analog Trunk 16

The IP400 Analog Trunk module (also known as the ATM16) is used to add 16 additional analog trunks to an IP Office system. The module supports both loop-start and, with suitable grounding, ground-start trunks.

- ⚠ WARNING**  
 In all IP Office installations, any module being used for analog trunk connections must be connected to a [functional earth](#)<sup>[35]</sup>.
- ⚠ WARNING**  
 Within the Republic of South Africa and in areas of high lightning risk, any module using analog trunk connections must be connected to a [protective ground](#)<sup>[35]</sup> and to [surge protection equipment](#)<sup>[36]</sup>.

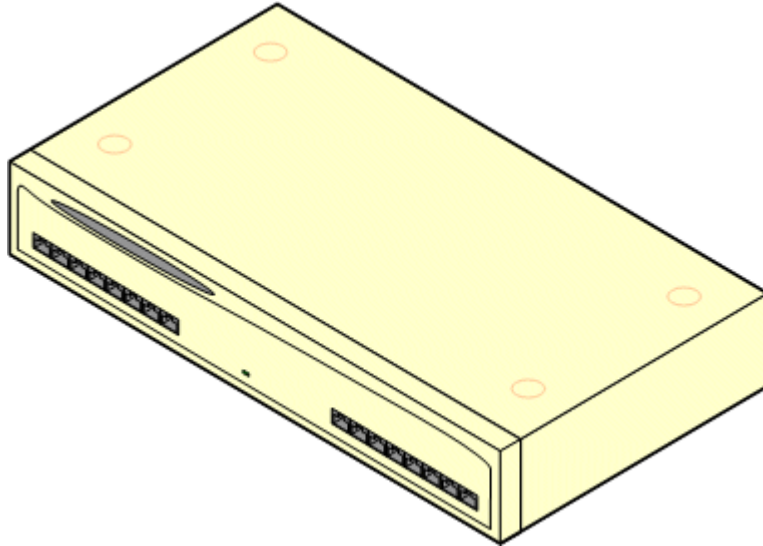

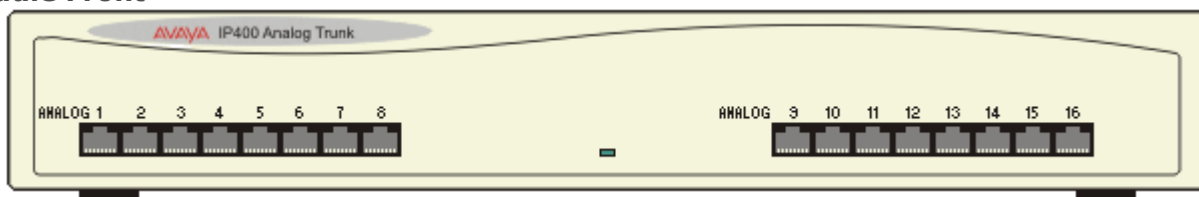

Feature	Details
<b>Locales</b>	Specific variants are provided for different IP Office locales, see below.
<b>Software Level</b>	IP Office core software level 1.0 minimum. Bin file = naatm16.bin.
<b>Included</b>	Power supply unit (see below) and Expansion Interconnect cable.
<b>Power Supply</b>	The module is supplied with a 2-pin, 40W external power supply unit. The PSU has an integral power cord for connection to the module's DC I/P socket. A locale specific <a href="#">IEC60320 C7 power cord</a> <sup>[30]</sup> for the external PSU is required but is not supplied with the module.
<b>Mounting</b>	The module is designed as a free-standing module that can be stacked on or under other IP Office modules. The module can be rack mounted in a 19" rack system using the optional IP400 Rack Mounting Kit.
<b>Dimensions</b>	Width: 445mm/17.5". Depth: 245mm/9.7". Height: 71mm/2.8"/2U.
<b>Weight</b>	Unboxed: 2.9Kg/6.6lbs. Boxed: 4.2Kg/9.4lbs.

### Module Front

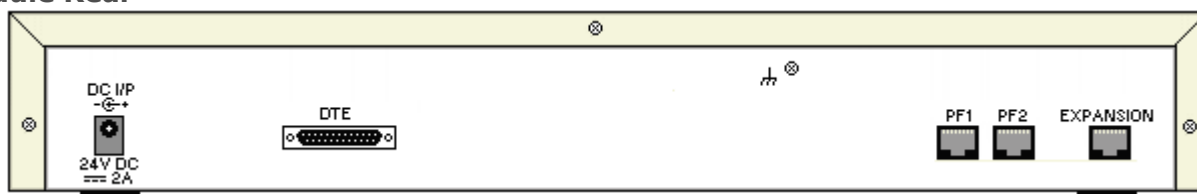

## Module Rear



Ports	Description
<a href="#">ANALOG</a> <sup>[356]</sup>	RJ45 socket. Used for connection to analog trunks. Ports can be configured as either loop-start or ground-start trunks through the IP Office configuration. In the event of power failure, Analog ports 1 and 2 are directly connected to analog extension ports PF1 and PF2 respectively. If used the connected phones must be clearly labeled as power failure devices. This is only supported for loop-start analog trunks.
<a href="#">DC I/P</a> <sup>[360]</sup>	DC power input port. Used for connection of the power lead from an Avaya 40W external power supply unit supplied with the expansion module. A locale specific <a href="#">IEC60320 C7 power cord</a> <sup>[30]</sup> for the external PSU is required but is not supplied with the module.
<a href="#">DTE</a> <sup>[367]</sup>	25-Way D-Type socket. For Avaya use only.
<a href="#">EXPANSION</a> <sup>[362]</sup>	RJ45 Socket. Used for direct connection to an Expansion port on an IP Office control unit using the Expansion Interconnect cable supplied with the module.
<a href="#">PF</a> <sup>[364]</sup>	RJ45 socket. Power failure analog extension ports. See Analog section above.
	Ground point. Used for connection of a <a href="#">functional earth</a> <sup>[35]</sup> if required. On older modules where this screw is not present, the top-center cover screw should be used instead. <ul style="list-style-type: none"> <li>• <b>IMPORTANT</b> In all IP Office installations, any module being used for analog trunk connections must be connected to a <a href="#">functional earth</a> <sup>[35]</sup>.</li> <li>• <b>⚠ WARNING</b> Within the Republic of South Africa and in areas of high lightning risk, any module using analog trunk connections must be connected to a <a href="#">protective ground</a> <sup>[35]</sup> and to <a href="#">surge protection equipment</a> <sup>[36]</sup>.</li> </ul>

## Part Codes and Related Equipment

All expansion modules are supplied with a base software level and should be upgraded to match the core software of the control unit in the IP Office system. Expansion modules include an external power supply unit (PSU) and an appropriate interconnect cable. They do not include a locale specific power cord for the external PSU or any phone extension cables.

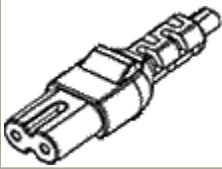
Item	Variant	Country	SAP Code
IP400 Analog Trunk 16	America	America	700211360
	Europe	Europe	700241680
	New Zealand	New Zealand	700241698
 IEC60320 C7 Power Cord	CEE7/16	Europe	700213382
	BS1363	United Kingdom	700213374
	NEMA1-15	America	700213390
	Korea	Korea	700254519
IP400 Rack Mounting Kit		All	700210800

## 12.6.2 Digital Station V2

The IP400 Digital Station V2 (also known as DS V2) is used to add additional DS ports to an IP Office system. The DS V2 is available in 16 and 30 port variants, referred to as DS16 V2 and DS30 V2 respectively.

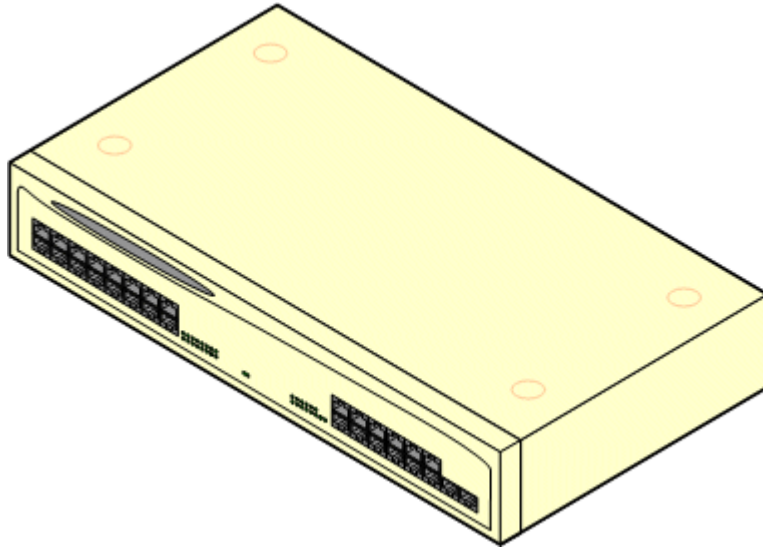

The DS V2 supersedes the original IP400 Digital Station, now referred to as a DS V1. The module version is indicated by labels both the base and the rear of the module.

Feature	Details
<b>Locales</b>	Supported in all <a href="#">IP Office locales</a> <sup>[43]</sup> .
<b>Software Level</b>	IP Office core software level 2.1(31) minimum. Bin file = nadcpV2.bin.
<b>Included</b>	Power supply unit (see below) and Expansion Interconnect cable.
<b>Power Supply</b>	The module is supplied with a Earthed 3-Pin, 60W external power supply module. The PSU has an integral power cord for connection to the module's DC I/P socket. A locale specific <a href="#">IEC60320 C13 power cord</a> <sup>[30]</sup> for the external PSU is required but is not supplied with the module.
<b>Mounting</b>	The module is designed as a free-standing module that can be stacked on or under other IP Office modules. The module can be rack mounted in a 19" rack system using the optional IP400 Rack Mounting Kit.
<b>Dimensions</b>	Width: 445mm/17.5". Depth: 245mm/9.7". Height: 71mm/2.8"/2U.
<b>Weight</b>	Unboxed: 3.5Kg/7.8lbs. Boxed: 4.8Kg/10.8lbs. (Based on DS30 V2)

### Module Front

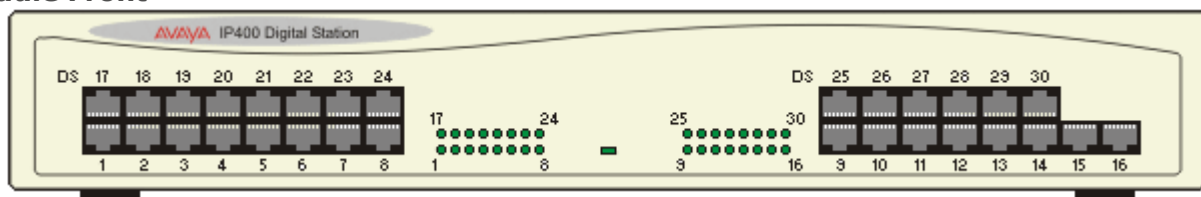

## Module Rear

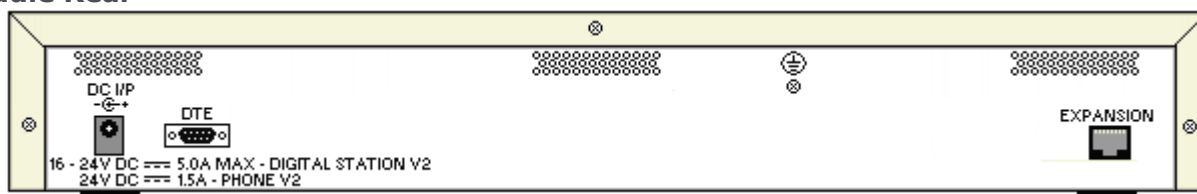

Ports	Description
<a href="#">DC I/P</a> <sup>[360]</sup>	DC power input port. Used for connection of the power lead from an Avaya earthed 60W external power supply unit supplied with the expansion module. A locale specific <a href="#">IEC60320 C13 power cord</a> <sup>[30]</sup> for the external PSU is required but is not supplied with the module.
<a href="#">DS</a> <sup>[360]</sup>	RJ45 socket. Digital Station port. Used for connection of IP Office <a href="#">supported DS phones</a> <sup>[39]</sup> . If connected to an <a href="#">out-of-building extension</a> <sup>[36]</sup> , the connection must be made via additional IROB barrier devices in addition to the buildings primary protection. The module must also be connected to a protective ground.
<a href="#">DTE</a> <sup>[367]</sup>	9-Way D-Type socket. For Avaya use only.
<a href="#">EXPANSION</a> <sup>[362]</sup>	RJ45 Socket. Used for direct connection to an Expansion port on an IP Office control unit using the Expansion Interconnect cable supplied with the module.
	Protective Ground point. Use of a protective ground is required for all installations, see <a href="#">Grounding (Earthing)</a> <sup>[35]</sup> . Where the module is connected to analog extensions in another building, an IP Office Phone Barrier Box V2 (101V) is required at both ends, see <a href="#">Lightning Protection/Out-of-Building Connections</a> <sup>[36]</sup> .

## Part Codes and Related Equipment

All expansion modules are supplied with a base software level and should be upgraded to match the core software of the control unit in the IP Office system. Expansion modules include an external power supply unit (PSU) and an appropriate interconnect cable. They do not include a locale specific power cord for the external PSU or any phone extension cables.

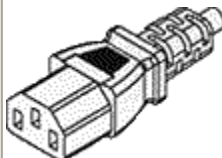
Item	Variant	Country	SAP Code
IP400 Digital Station V2	16 Ports	All	700359839
	30 Ports		700359847
 IEC60320 C13 Power Cord	CEE7/7	Europe	700289762
	BS1363	United Kingdom	700289747
	NEMA5-15P	America	700289770
IP400 Rack Mounting Kit		All	700210800

### 12.6.3 Phone V2

The IP400 Phone V2 module (also known as the Phone V2 module) is used to add additional PHONE ports to an IP Office system. PHONE ports are used for analog phones.

The Phone V2 module is available in 8, 16 and 30 port variants, referred to as the Phone 8, Phone 16 and Phone 30 respectively.

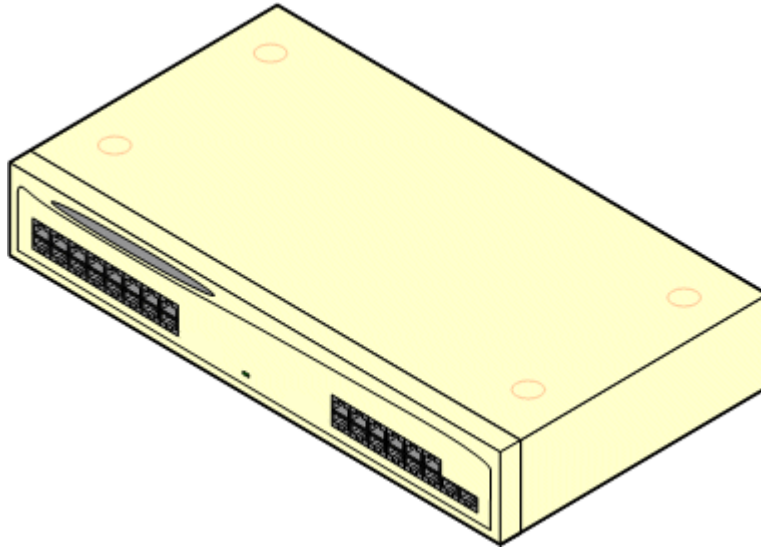

The Phone V2 module supersedes the original IP400 Phone module, now referred to as the Phone V1. The module version is indicated by labels on both the base and the rear of the module. Key changes are:

- The Phone V2 uses an earthed 3-pin 60W external power supply unit.
- With IP Office 3.1, the message waiting indication (MWI) on each port can be configured for **None**, **On**, **51V Stepped**, **81V**, **Line Reversal A** or **Line Reversal B**. **On** uses the default determined by the system locale. Ports on a Phone V2 module can additionally be configured for **101V** operation.
- These ports do not include a ringing capacitor. Therefore for connection to 4-wire analog phones, where this is a requirement (typically the United Kingdom and New Zealand), connection should be via a Master socket containing ringing capacitors.
- The DTE serial port on the rear of the module has been changed to a 9-pin D-type socket.

Feature	Details
<b>Locales</b>	Supported in all IP Office locales.
<b>Software Level</b>	IP Office core software level 2.1(36) minimum. Bin file = dvpots.bin.
<b>Included</b>	Power supply unit (see below) and Expansion Interconnect cable.
<b>Power Supply</b>	The module is supplied with a Earthed 3-Pin, 60W external power supply unit. The PSU has an integral power cord for connection to the module's DC I/P socket. A locale specific <a href="#">IEC60320 C13 power cord</a> <sup>(30)</sup> for the external PSU is required but is not supplied with the module.
<b>Mounting</b>	The module is designed as a free-standing module that can be stacked on or under other IP Office modules. The module can be rack mounted in a 19" rack system using the optional IP400 Rack Mounting Kit.
<b>Dimensions</b>	Width: 445mm/17.5". Depth: 245mm/9.7". Height: 71mm/2.8"/2U.
<b>Weight</b>	Unboxed: 3.1Kg/6.94lbs. Boxed: 4.4Kg/9.7lbs. (Based on Phone 30 V2)

#### Module Front

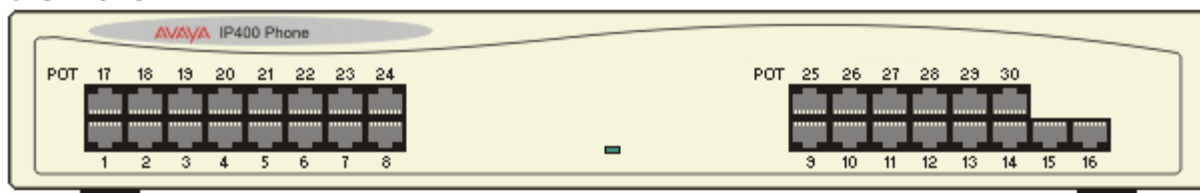

## Module Rear

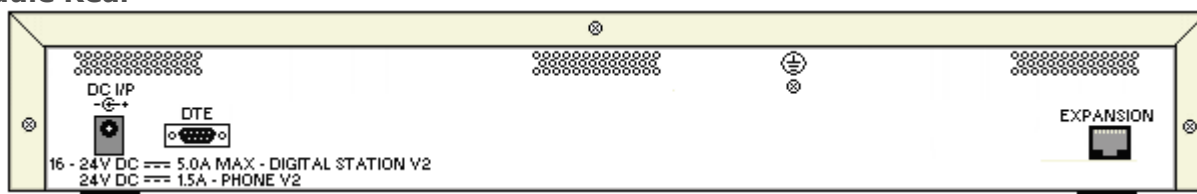

Ports	Description
<a href="#">DC I/P</a> <sup>[366]</sup>	DC power input port. Used for connection of the power lead from an Avaya earthed 60W external power supply unit supplied with the expansion module. A locale specific <a href="#">IEC60320 C13 power cord</a> <sup>[30]</sup> for the external PSU is required but is not supplied with the module.
<a href="#">DTE</a> <sup>[367]</sup>	9-Way D-Type socket. For Avaya use only.
<a href="#">EXPANSION</a> <sup>[362]</sup>	RJ45 Socket. Used for direct connection to an Expansion port on an IP Office control unit using the Expansion Interconnect cable supplied with the module.
<a href="#">PHONE</a> <sup>[365]</sup>	RJ45 socket. Used for connection of analog phones. Intended for two-wire analog phones. For connection to 4-wire analog phones connection should be via a master socket with ringing capacitors. If connected to an <a href="#">out-of-building extension</a> <sup>[368]</sup> , the connection must be made via additional <a href="#">IP Office Barrier Boxes</a> <sup>[174]</sup> in addition to the buildings primary protection. The module must also be connected to a protective ground.
	Protective Ground point. Use of a protective ground is required for all installations, see Grounding (Earthing). Where the module is connected to analog extensions in another building, an IP Office Phone Barrier Box V2 (101V) is required at both ends, see <a href="#">Lightning Protection/Out-of-Building Connections</a> <sup>[369]</sup> .

## Part Codes and Related Equipment

All expansion modules are supplied with a base software level and should be upgraded to match the core software of the control unit in the IP Office system. Expansion modules include an external power supply unit (PSU) and an appropriate interconnect cable. They do not include a locale specific power cord for the external PSU or any phone extension cables.

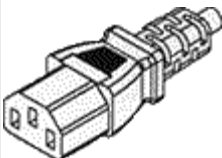
Item	Variant	Country	SAP Code
IP400 Phone V2	8 Ports	All	700359896
	16 Ports		700359904
	30 Ports		700359912
 IEC60320 C13 Power Cord	CEE7/7	Europe	700289762
	BS1363	United Kingdom	700289747
	NEMA5-15P	America	700289770
IP400 Rack Mounting Kit		All	700210800



## 12.7 SD Cards

The serial number of the card fitted to the IP Office control unit is used as the basis for all licenses issued for that IP Office system and is used to regularly re-validate the licenses. If the card is removed, over the next few hours licensed features will stop operating.

## 12.8 Mounting Kits

The following mounting kits are available for use with IP Office systems.

### 12.8.1 IP500 Wall Mounting Kits

IP500 V2 control units and IP500 external expansion modules can be wall or rack mounted. To do this, a wall mounting kit is required in addition to suitable wall fixings.

In addition to the existing [environmental requirements](#)<sup>[53]</sup> for an IP Office system, the following additional requirements apply when wall mounting a unit:

- The wall surface must be vertical, flat and vibration free. Attachment to temporary walls is not supported.
- Only the screws provided with the mounting kit should be used to attach the brackets to the control unit.

The following wall and rack mounting kit is currently available:

- **IPO IP500 RACK MNTG KIT V3** (SAP Code 700503160)

These kits can be used for wall and rack mounting of an IP500 V2 control unit and IP500 external expansion modules. The kits incorporate cable routing at the front and rear of the unit. For wall mounted control units it allows orientation of the control unit base card slots to the left or to the right.

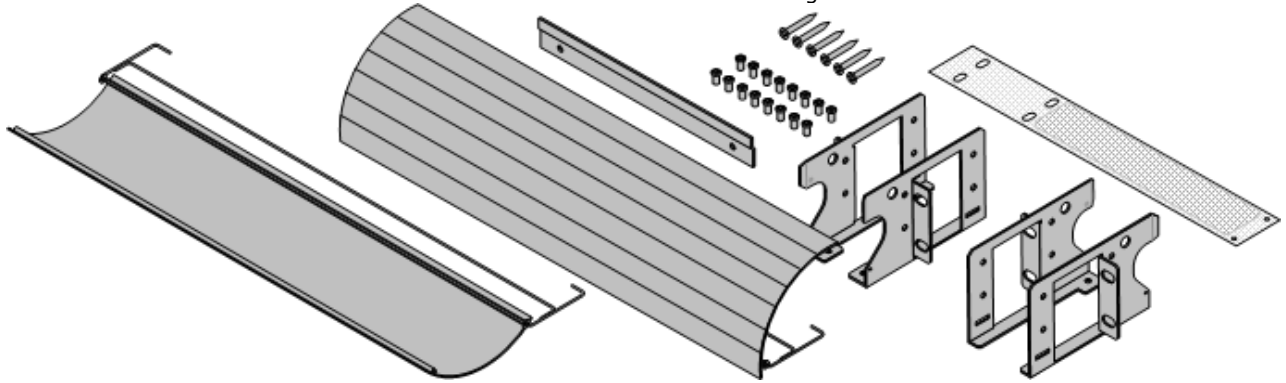

### 12.8.2 Barrier Box Rack Mounting Kit

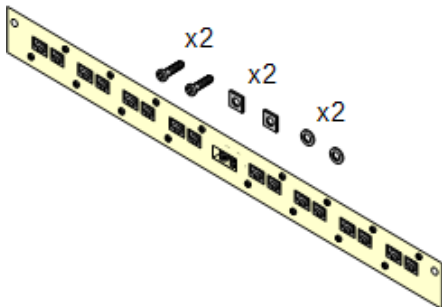

- **Barrier Box Rack Mounting Kit** (SAP 700293905)  
Barrier boxes must be used for [out-of-building analog phone extensions](#)<sup>[36]</sup>. This bracket allows up to 8 IP Office barrier boxes to be rack mounted and simplifies the number of connections to the protective ground point in the rack. This kit must be used when more than 3 barrier boxes are in use and supports a maximum of 16 barrier boxes for a single external expansion module.

---

## 12.9 Phones

IP Office Release 9.1 supports the following phones and phone add-ons. Availability may depend on location and may be subject to local restrictions.

### Enhanced Tip and Ring (ETR Ports)

These phones are only supported on an ETR6 card in a IP500 V2 systems. They are only supported in IP Office Basic Edition - PARTNER® Mode and IP Office Basic Edition systems running a North American locale and U-Law companding.

- **ETR Series:** [ETR6](#)<sup>[310]</sup>, [ETR6D](#)<sup>[310]</sup>, [ETR18](#)<sup>[310]</sup>, [ETR18D](#)<sup>[310]</sup>, [ETR34D](#)<sup>[312]</sup> (*ETR 34D phones are limited to a maximum of 2 per card and 4 in total*)
- **PARTNER DECT:** [3910](#)<sup>[270]</sup>, [3920](#)<sup>[270]</sup>

### Avaya DS Digital Telephones (DS Ports)

These digital stations connect to the IP Office via [DS](#)<sup>[360]</sup> ports. They are supported by all IP Office modes.

- **1400 Series:** [1403](#)<sup>[240]</sup>, [1408](#)<sup>[240]</sup>, [1416](#)<sup>[240]</sup>
- **9500 Series:** [9504](#)<sup>[280]</sup>, [9508](#)<sup>[280]</sup>

The following additional DS port phones are only supported in IP Office standard modes:

- **2400 Series:** [2402](#)<sup>[250]</sup>, [2410](#)<sup>[250]</sup>, [2420](#)<sup>[250]</sup>.
- **3800 Series:** [3810 Wireless phone](#)<sup>[260]</sup> (Only supported on external expansion modules).
- **4400 Series:** [4406D](#)<sup>[270]</sup>, [4412D+](#)<sup>[270]</sup>, [4424D+](#)<sup>[270]</sup> (Only supported on external expansion modules).
- **5400 Series:** [5402](#)<sup>[280]</sup>, [5410](#)<sup>[280]</sup>, [5420](#)<sup>[280]</sup>.
- **T3 Series:** [T3 Compact](#)<sup>[320]</sup>, [T3 Classic](#)<sup>[320]</sup>, [T3 Comfort](#)<sup>[320]</sup>.

### Avaya BST Digital Telephones (BST Ports)

These digital stations connect to the IP500 V2 IP Office system via BST ports.

- **4100 Series:** 4135, 4136, 4145, 4145EX, 4146, 4146EX - Connection to IP Office BST ports via a [Digital Mobility Solution](#)<sup>[330]</sup> system.
- **7400 Series:** 7420, 7430, 7434, 7439, 7440, 7444, 7449 - Connection to IP Office BST ports via a [Digital Mobility Solution](#)<sup>[330]</sup> system.
- **ACU:** [Audio Conferencing Unit](#)<sup>[300]</sup>
- **M-Series:** [M7100](#)<sup>[310]</sup>, [M7100N](#)<sup>[310]</sup>, [M7208](#)<sup>[310]</sup>, [M7208N](#)<sup>[310]</sup>, [M7310](#)<sup>[310]</sup>, [M7310N](#)<sup>[310]</sup>, [M7324](#)<sup>[310]</sup>, [M7324N](#)<sup>[310]</sup>.
- **T-Series:** [T7000](#)<sup>[310]</sup>, [T7100](#)<sup>[310]</sup>, [T7208](#)<sup>[310]</sup>, [T7316](#)<sup>[310]</sup>, [T7316E](#)<sup>[320]</sup>, [T7406](#)<sup>[320]</sup>, [T7406E](#)<sup>[320]</sup>

### Analog Telephones

Analog phones and devices connect to [PHONE](#)<sup>[360]</sup> ports with the IP Office system. However due to the variety of analog phones and device available no guarantee of operation is given. It is the responsibility of the IP Office installer and maintainer to test and verify the operation of proposed analog equipment. Analog message waiting indication (MWI) is only supported with Avaya 6200 Series phones.

- **6200 Series:** 6211, 6219, 6221 (*North America*).
- **B100 Series:** [B149](#)<sup>[300]</sup>, [B159](#)<sup>[300]</sup>, B169.
- **Interquartz Gemini:** 9330-AV, 9335-AV, 9281-AV (*Europe, Middle East, Africa, Asia-Pacific*).

### IP Telephones

IP Phones (SIP and H323) connect to the IP Office system via the RJ45 LAN or WAN. These device require an Avaya IP Endpoint license and voice compression resources. They are not supported in IP Office Basic Edition - PARTNER® Mode, IP Office Basic Edition - Norstar Mode and IP Office Basic Edition mode.

#### H323:

- **1600 Series:** [1603IP/SW](#)<sup>[240]</sup>, [1608](#)<sup>[250]</sup>, [1608-I](#)<sup>[250]</sup>, [1616](#)<sup>[250]</sup>, [1616-I](#)<sup>[250]</sup>
- **3600 Series:** [3616](#)<sup>[250]</sup>, [3620](#)<sup>[250]</sup>, [3626](#)<sup>[260]</sup>, [3641](#)<sup>[260]</sup>, [3645](#)<sup>[260]</sup>
- **3700 Series:** [3701](#)<sup>[260]</sup>, [3711](#)<sup>[260]</sup> - Connection via DECT base stations. [3720](#)<sup>[260]</sup>, [3725](#)<sup>[260]</sup>, [3740](#)<sup>[260]</sup>, [3749](#)<sup>[260]</sup> - Connection via DECT R4 base stations.
- **4600 Series:** [4601](#)<sup>[270]</sup>, [4602](#)<sup>[270]</sup>, [4602SW](#)<sup>[270]</sup>, [4610](#)<sup>[270]</sup>, [4610SW](#)<sup>[270]</sup>, [4620](#)<sup>[270]</sup>, [4620SW](#)<sup>[270]</sup>, [4621SW](#)<sup>[270]</sup>, [4625](#)<sup>[270]</sup>.
- **5600 Series:** [5601](#)<sup>[280]</sup>, [5602](#)<sup>[280]</sup>, [5602SW](#)<sup>[280]</sup>, [5610](#)<sup>[280]</sup>, [5620](#)<sup>[280]</sup>, [5621](#)<sup>[280]</sup>.
- **9600 Series:** [9608](#)<sup>[290]</sup>, [9608G](#)<sup>[290]</sup>, [9611G](#)<sup>[290]</sup>, [9620L](#)<sup>[290]</sup>, [9620C](#)<sup>[290]</sup>, [9621G](#)<sup>[290]</sup>, [9630G](#)<sup>[290]</sup>, [9640](#)<sup>[300]</sup>, [9640G](#)<sup>[300]</sup>, [9641G](#)<sup>[300]</sup>, [9650](#)<sup>[300]</sup>, [9650C](#)<sup>[300]</sup>.
- **T3 IP Series:** [T3 IP Compact](#)<sup>[320]</sup>, [T3 IP Classic](#)<sup>[320]</sup>, [T3 IP Comfort](#)<sup>[320]</sup>.

#### SIP:

- **1000 Series:** [1010](#)<sup>[240]</sup>, [1040](#)<sup>[240]</sup>
- **1100 Series:** [1120E](#)<sup>[240]</sup>, [1140E](#)<sup>[240]</sup>

- **1200 Series:** [1220](#)<sup>[245]</sup>, [1230](#)<sup>[245]</sup>
- **B100 Series:** [B179](#)<sup>[307]</sup>.
- **D100 Series:** These DECT handsets (up to 8) use a base station that connects to the IP Office system using a SIP trunk and appear on the IP Office as SIP extensions.
- **E129:** A simple SIP telephone, the [E129](#)<sup>[309]</sup> support auto-answer, handsfree and headset operation.
- **E169:** A SIP telephone that supports the docking of mobile devices.

---

## 12.9.1 1010/1040

The 1000 Series phones are high-quality SIP video phone devices. The 1010 and 1040 phones are supported. Each consists of a main module to which a range of video camera and microphone/speaker devices can be attached. The main module provides outputs for display of video on HD video compatible devices

- The availability of [VCM \(Voice Compression Module\)](#)<sup>[42]</sup> channels is necessary to support IP telephony. For IP Office 6.0+, these phones require an [Avaya IP Endpoints](#)<sup>[372]</sup> license.



*1010 Main module with camera, microphone and remote control*

## 12.9.2 1120/1140/1220/1230

These Avaya SIP telephones are supported by IP Office Release 6.1 and higher.

- The availability of [VCM \(Voice Compression Module\)](#)<sup>[42]</sup> channels is necessary to support IP telephony. For IP Office 6.0+, these phones require an [Avaya IP Endpoints](#)<sup>[372]</sup> license.



1120 Telephone



1140 Telephone



1120 Telephone

















1140 Telephone

### 12.9.3 1403

This phone is supported with IP Office Release 6.0 and higher.

1603	Feature	1403
	Connects via	DS port.
	IP Office Release	6.0
	Programmable Buttons	✓ 3
	Headset Socket	✗
	Handsfree Speaker/ Microphone	✓/✓
	Message Waiting Lamp	✓
	Display	2 x 16 backlit.
	Supported Add-Ons	None
	Upgradeable Firmware	✓

#### Fixed Telephony Function Keys

✓  SPEAKER	✗  HEADSET	✓  MUTE	✓  VOLUME UP	✗  CONTACTS
✗  MESSAGE	✓  HOLD	✓  TRANSFER	✓  VOLUME DOWN	✗  CALL LOG
✓  DROP	✓  REDIAL	✓  CONFERENCE	✓  MENU	















Variant		SAP Code
1403 Telephone	Black	700469927

## 12.9.4 1408

This phone is supported with IP Office Release 6.0 and higher.

1408	Feature	1408
	Connects via	DS port.
	IP Office Release	6.0+
	Programmable Buttons	✓ 8
	Headset Socket	✓
	Handsfree Speaker/Microphone	✓/✓
	Message Waiting Lamp	✓
	Display	3 x 24 backlit.
	Supported Add-Ons	None.
	Upgradeable Firmware	✓

## Fixed Function Keys

✓  SPEAKER	✓  HEADSET	✓  MUTE	✓  VOLUME UP	✓  CONTACTS
✓  MESSAGE	✓  HOLD	✓  TRANSFER	✓  VOLUME DOWN	✓  CALL LOG
✓  DROP	✓  REDIAL	✓  CONFERENCE	✓  MENU	

Variant		SAP Code
1408 Telephone	Black	700469851

## 12.9.5 1416

This phone is supported with IP Office Release 6.0 and higher. When used with a DBM32 button module, the telephone must be powered from a 1151D1/D2 power supply unit.

1416	Feature	1416
	Connects via	DS port.
	IP Office Release	6.0+
	Programmable Buttons	✓ 16
	Headset Socket	✓
	Handsfree Speaker/ Microphone	✓/✓
	Message Waiting Lamp	✓
	Display	4 x 24 Backlit.
	Supported Add-Ons	<a href="#">DBM32</a> <sup>[329]</sup> x 3.
Upgradeable Firmware	✓	

### Fixed Function Keys

✓  SPEAKER	✓  HEADSET	✓  MUTE	✓  VOLUME UP	✓  CONTACTS
✓  MESSAGE	✓  HOLD	✓  TRANSFER	✓  VOLUME DOWN	✓  CALL LOG
✓  DROP	✓  REDIAL	✓  CONFERENCE	✓  MENU	

Variant		SAP Code
1416 Telephone	Black	700469869
DBM32 Button Module	Black	700469968

















## 12.9.6 1603

This phone is supported with IP Office 4.2 and higher. Support for the 1603SW model was added in IP Office 5.0. Support for the I variants was added in IP Office Release 6.0 and in 5.0 maintenance releases.

- The availability of [VCM \(Voice Compression Module\)](#)<sup>[42]</sup> channels is necessary to support IP telephony. For IP Office 6.0+, these phones require an [Avaya IP Endpoints](#)<sup>[37]</sup> license.

1603	Feature	1603-I	1603SW-I
	<b>Connects via</b>	IP network.	
	<b>IP Office Release</b>	4.2 Q4 2008 +	5.0+
	<b>Programmable Buttons</b>	✓ 3	
	<b>Headset Socket</b>	✗	
	<b>Handsfree Speaker/ Microphone</b>	✓/✓	
	<b>Message Waiting Lamp</b>	✓	
	<b>PoE Class/Typical Idle Power Consumption</b>	Class 2 (4.3W)	Class 2 (4.3W)
	<b>Display</b>	2 x 16 backlit.	
	<b>Supported Add-Ons</b>	None	
	<b>Upgradeable Firmware</b>	✓	✓
<b>PC Pass-Through Port/ with Voice Priority</b>	✗/✗	✓/✓	

### Fixed Telephony Function Keys

✓  SPEAKER	✗  HEADSET	✓  MUTE	✓  VOLUME UP	✗  CONTACTS
✗  MESSAGE	✓  HOLD	✓  TRANSFER	✓  VOLUME DOWN	✗  CALL LOG
✓  DROP	✓  REDIAL	✓  CONFERENCE	✓  MENU	

Material Description	Code
<b>Phones</b> (Ethernet cord sold separately. Local power sold separately. PoE adapter sold separately.)	
1603IP Phone	700415540
1603SW Phone	700458508
1603-I Telephone	700476849
1603SW-I Telephone	700458524
Replacement Wedge Stand	700415615
<b>Accessories</b>	
CAT5 Ethernet Cable (14 ft)	700383326
CAT5 Ethernet Cable (1 ft)	700436710
<b>Power Adapters</b>	
1603 PoE adapter	700415607
Power Adapter for 1600 IP Phones 5V US	700451230
Power Adapter for 1600 IP Phones 5V UK	700451248
Power Adapter for 1600 IP Phones 5V EU	700451255
Power Adapter for 1600 IP Phones 5V ARGENTINA	700451263
Power Adapter for 1600 IP Phones 5V KOREA	700451271

---

<b>Material Description</b>	<b>Code</b>
Power Adapter for 1600 IP Phones 5V CHINA	700451289
Power Adapter for 1600 IP Phones 5V AUSTRALIA	700451297
<b>Labels</b>	
1603 Paper DESI Labels - Pack of 50 Labels (8.5" x 11")	700415706
1603 Paper DESI Labels - Pack of 50 Labels (A4)	700434210

## 12.9.7 1608

This phone is supported with IP Office 4.2 and higher. Support for the I variant was added in IP Office Release 6.0 and in 5.0 maintenance releases.

- The availability of [VCM \(Voice Compression Module\)](#)<sup>[42]</sup> channels is necessary to support IP telephony. For IP Office 6.0+, these phones require an [Avaya IP Endpoints](#)<sup>[37]</sup> license.

1608	Feature	1608
	<b>Connects via</b>	IP network.
	<b>IP Office Release</b>	4.2 Q4 2008 +
	<b>Programmable Buttons</b>	✓ 8
	<b>Headset Socket</b>	✓
	<b>Handsfree Speaker/Microphone</b>	✓/✓
	<b>Message Waiting Lamp</b>	✓
	<b>PoE Class/Typical Idle Power Consumption</b>	Class 2 (4.7W)
	<b>Display</b>	3 x 24 backlit.
	<b>Supported Add-Ons</b>	None.
	<b>Upgradeable Firmware</b>	✓
<b>PC Pass-Through Port/with Voice Priority</b>	✓/✓	

### Fixed Function Keys

✓  SPEAKER	✓  HEADSET	✓  MUTE	✓  VOLUME UP	✓  CONTACTS
✓  MESSAGE	✓  HOLD	✓  TRANSFER	✓  VOLUME DOWN	✓  CALL LOG
✓  DROP	✓  REDIAL	✓  CONFERENCE	✓  MENU	

Material Description	Code
<b>Phones</b> (Ethernet cord sold separately. Local power sold separately. PoE adapter sold separately.)	
1608 IP Phone	700415557
1608-I IP Phone	700458532
Replacement Stand	700415714
Wall Mounting Kit	700415623
<b>Accessories</b>	
CAT5 Ethernet Cable (14 ft)	700383326
CAT5 Ethernet Cable (1 ft)	700436710
1608 Wall Mount Kit (Includes 1 ft Ethernet cable and screws)	700415623
<b>Power Adapters</b>	
Power Adapter for 1600 IP Phones 5V US	700451230
Power Adapter for 1600 IP Phones 5V UK	700451248
Power Adapter for 1600 IP Phones 5V EU	700451255
Power Adapter for 1600 IP Phones 5V ARGENTINA	700451263
Power Adapter for 1600 IP Phones 5V KOREA	700451271
Power Adapter for 1600 IP Phones 5V CHINA	700451289
Power Adapter for 1600 IP Phones 5V AUSTRALIA	700451297
<b>Labels</b>	

<b>Material Description</b>	<b>Code</b>
1608 Paper DESI Labels - Pack of 50 Labels (8.5" x 11")	700415649
1608 Paper DESI Labels - Pack of 50 Labels (A4)	700434228
<b>Headsets</b>	
HIS Headset Cable for 9600 & 1608/1616 IP Phones	700409881
SupraElite Monaural (One Ear) Voice Tube (HIS cable required)	700343718
SupraElite Monaural (One Ear) Noise Cancelling (HIS cable required)	700343726
SupraElite Monaural (Two Ear) Voice Tube (HIS cable required)	700343734
SupraElite Monaural (Two Ear) Noise Cancelling (HIS cable required)	700343742
AWH-55+ Wireless Headset	700428204
AWH-65+ Wireless Headset - UK	700428212
AWH-65+ Wireless Headset - EURO	700428220
AWH75N Executive Wireless Headset NAR	700446313
AWH75N Executive Wireless Headset EU	700446321
AWH75N Executive Wireless Headset UK	700446339
ABT-35+S Headset & Base - NA	700428170
ABT-35+S Headset & Base - EURO	700428196

## 12.9.8 1616

This phone is supported with IP Office 4.2 and higher. Support for the I variant was added in IP Office Release 6.0 and in 5.0 maintenance releases.

- The availability of [VCM \(Voice Compression Module\)](#)<sup>[42]</sup> channels is necessary to support IP telephony. For IP Office 6.0+, these phones require an [Avaya IP Endpoints](#)<sup>[37]</sup> license.

1616	Feature	1616
	<b>Connects via</b>	IP network.
	<b>IP Office Release</b>	4.2 Q4 2008+
	<b>Programmable Buttons</b>	✓ 16
	<b>Headset Socket</b>	✓
	<b>Handsfree Speaker/ Microphone</b>	✓/✓
	<b>Message Waiting Lamp</b>	✓
	<b>PoE Class/Typical Idle Power Consumption</b>	Class 2
	<b>Display</b>	4 x 24 Backlit.
	<b>Supported Add-Ons</b>	<a href="#">BM32</a> <sup>[32]</sup> x 3.
	<b>Upgradeable Firmware</b>	✓
	<b>PC Pass-Through Port/with Voice Priority</b>	✓/✓

### Fixed Function Keys

✓  SPEAKER	✓  HEADSET	✓  MUTE	✓  VOLUME UP	✓  CONTACTS
✓  MESSAGE	✓  HOLD	✓  TRANSFER	✓  VOLUME DOWN	✓  CALL LOG
✓  DROP	✓  REDIAL	✓  CONFERENCE	✓  MENU	

Material Description	Code
<b>Phones</b> (Ethernet cord sold separately. Local power sold separately. PoE adapter sold separately.)	
1616 IP Phone	700450190
1616-I IP Phone	700458540
BM32 Button Module for 1616 (includes cable and bridge)	700415573
Replacement Stand	700415722
<b>Accessories</b>	
CAT5 Ethernet Cable (14 ft)	700383326
CAT5 Ethernet Cable (1 ft)	700436710
1616 Wall Mount Kit (Includes 1 ft Ethernet cable and screws)	700415631
<b>Power Adapters</b>	
Power Adapter for 1600 IP Phones 5V US	700451230
Power Adapter for 1600 IP Phones 5V UK	700451248
Power Adapter for 1600 IP Phones 5V EU	700451255
Power Adapter for 1600 IP Phones 5V ARGENTINA	700451263
Power Adapter for 1600 IP Phones 5V KOREA	700451271
Power Adapter for 1600 IP Phones 5V CHINA	700451289
Power Adapter for 1600 IP Phones 5V AUSTRALIA	700451297
<b>Labels</b>	







<b>Material Description</b>	<b>Code</b>
1616/BM32 Paper DESI Labels - Pack of 50 Labels (8.5" x 11")	700415656
1616/BM32 Paper DESI Labels - Pack of 50 Labels (A4)	700434236
<b>Headsets</b>	
HIS Headset Cable for 9600 & 1608/1616 IP Phones	700409881
SupraElite Monaural (One Ear) Voice Tube (HIS cable required)	700343718
SupraElite Monaural (One Ear) Noise Cancelling (HIS cable required)	700343726
SupraElite Monaural (Two Ear) Voice Tube (HIS cable required)	700343734
SupraElite Monaural (Two Ear) Noise Cancelling (HIS cable required)	700343742
AWH-55+ Wireless Headset	700428204
AWH-65+ Wireless Headset - UK	700428212
AWH-65+ Wireless Headset - EURO	700428220
AWH75N Executive Wireless Headset NAR	700446313
AWH75N Executive Wireless Headset EU	700446321
AWH75N Executive Wireless Headset UK	700446339
ABT-35+S Headset & Base - NA	700428170
ABT-35+S Headset & Base - EURO	700428196

## 12.9.9 2402

In addition to the two physical programmable buttons, the  FEATURE key plus 0-9, \* and # can be used to access an additional 12 programmable slots.

On IP Office, the 2402D display is not used.

2402D	Feature	Detail
	Connects via	DS port.
	IP Office Release	3.0+
	Programmable Buttons	✓ 2   *.
	Headset Socket	✗
	Handsfree Speaker/Microphone	✓/✗
	Message Waiting Lamp	✓
	Display	Not used.
	Supported Add-Ons	None.
	Upgradable Firmware	✓

Standard DCP Phone Keys			
✗  SPEAKER	✗  HEADSET	✓  MUTE	✓  VOLUME UP
✓  MESSAGES	✓  HOLD	✓  TRANSFER	✓  VOLUME DOWN
✓  DROP	✓  REDIAL	✓  CONFERENCE	

Variant	SAP Code	
2402D	Multi-Grey	700381973
Replacement Handset	Dark Grey	700203797
Amplified Handset	Dark Grey	700229735
Noisy Location Handset	Dark Grey	700229743
Push to Talk Handset	Dark Grey	700229727

## 12.9.10 2410

2410D	Feature	2410
	Connects via	DS port.
	IP Office Release	3.0+
	Programmable Buttons	✓ 12. (6 buttons x 2 pages).
	Headset Socket	✓
	Handsfree Speaker/ Microphone	✓/✓
	Message Waiting Lamp	✓
	Display	29 characters x 5 lines. (168 x 80 pixels).
	Supported Add-Ons	None.
	Upgradable Firmware	✓

### Standard DCP Phone Keys

✓  SPEAKER	✓  HEADSET	✓  MUTE	✓  VOLUME UP
✓  MESSAGES	✓  HOLD	✓  TRANSFER	✓  VOLUME DOWN
✓  DROP	✓  REDIAL	✓  CONFERENCE	

Variant		SAP Code
2410	Multi-Grey	700381999
Replacement Handset	Dark Grey	700203797
Amplified Handset	Dark Grey	700229735
Noisy Location Handset	Dark Grey	700229743
Push to Talk Handset	Dark Grey	700229727



## 12.9.11 2420

2420D	Feature	Details
	<b>Connects via</b>	DS port.
	<b>IP Office Release</b>	1.4+
	<b>Programmable Buttons</b>	✓ 24 (8 buttons x 3 pages)
	<b>Headset Socket</b>	✓
	<b>Handsfree Speaker/ Microphone</b>	✓/✓
	<b>Message Waiting Lamp</b>	✓
	<b>Display</b>	29 characters x 7 lines.
	<b>Supported Add-Ons</b>	EU24*, 201B.
	<b>Upgradable Firmware</b>	✓

## Standard DCP Phone Keys

✓  SPEAKER	✓  HEADSET	✓  MUTE	✓  VOLUME UP
✓  MESSAGES	✓  HOLD	✓  TRANSFER	✓  VOLUME DOWN
✓  DROP	✓  REDIAL	✓  CONFERENCE	

Variant		SAP Code
2420	Multi-Grey	700381585
Replacement Handset	Dark Grey	700203797
Amplified Handset	Dark Grey	700229735
Noisy Location Handset	Dark Grey	700229743
Push to Talk Handset	Dark Grey	700229727
201B Recorder Interface Module		700381635
20B Stand		700381650
EU24*	Multi-Grey	700381817
1151D1 Power Supply	With CAT5 cable.	700434897
1151D2 Power Supply with battery backup.	With CAT5 cable.	700434905
1151D1/1151D2 Power Cord	USA	405362641
	Europe	407786623
	Australia/New Zealand	407786631
	India	407790991
	United Kingdom	407786599
	Argentina	408161453

\*When used with an EU24 unit, a 1151 type power supply unit must be used to power the phone.

## 12.9.12 3616

This is an 802.11b WiFi phone. It connects to the IP Office via a wireless access point and Avaya Voice Priority Processor (AVPP).

- The availability of [VCM \(Voice Compression Module\)](#)<sup>[42]</sup> channels is necessary to support IP telephony. For IP Office 6.0+, these phones require an [Avaya IP Endpoints](#)<sup>[37]</sup> license.

3616	Feature	Detail
	<b>Connects via</b>	IP network.
	<b>IP Office Release</b>	2.0+
	<b>Programmable Buttons</b>	✓ 6.
	<b>Headset Socket</b>	✓
	<b>Message Waiting Lamp</b>	✗
	<b>Upgradable Firmware</b>	✗

Variant	SAP Code
3616 Wireless Phone	700413040
Additional battery pack for 3616	700277387
Desktop charger for 3616.	700412901
Clip for 3616	700413057
3616/3626 Configuration Cradle	700375934

### 12.9.13 3620

This is an 802.11b WiFi phone. It connects to the IP Office via a wireless access point and Avaya Voice Priority Processor (AVPP).

The 3620 is similar to the 3616 but has been designed for use in healthcare environments. It is waterproof and has a back lit display.

- The availability of [VCM \(Voice Compression Module\)](#)<sup>[42]</sup> channels is necessary to support IP telephony. For IP Office 6.0+, these phones require an [Avaya IP Endpoints](#)<sup>[372]</sup> license.

3616	Feature	Detail
	<b>Connects via</b>	IP network.
	<b>IP Office Release</b>	3.2+
	<b>Programmable Buttons</b>	✓ 6.
	<b>Headset Socket</b>	✓
	<b>Message Waiting Lamp</b>	✗
	<b>Upgradable Firmware</b>	✗

Variant	SAP Code
3620 Wireless Phone	700413065
Additional battery pack.	700277387
Desktop charger.	700412901
Clip	700413057
Configuration Cradle	700375934

## 12.9.14 3626

This phone is similar to the 3616 in functionality. However the 3626 has a ruggedized construction. This is an 802.11b WiFi phone. It connects to the IP Office via a wireless access point and Avaya Voice Priority Processor (AVPP).

- The availability of [VCM \(Voice Compression Module\)](#)<sup>[42]</sup> channels is necessary to support IP telephony. For IP Office 6.0+, these phones require an [Avaya IP Endpoints](#)<sup>[37]</sup> license.

3626	Feature	Detail
	Connects via	IP network.
	IP Office Release	2.0+
	Programmable Buttons	✓ 6.
	Headset Socket	✓
	Message Waiting Lamp	✗
	Upgradable Firmware	✗

Variant	SAP Code	
3626 Wireless Phone	700413024	
Additional battery pack for 3626	700277395	
Desktop charger for 3626	700412919	
3626 Gang changer	700412927	
Clip for 3626	700413131	
3626 Vinyl case with keypad cover	700412984	
3626 Carry case	Yellow	700289309
3626 Carry case with keypad cover	Black	700289317
	Yellow	700289325
3616/3626 Configuration Cradle	700375934	

## 12.9.15 3641

The Avaya 3641 IP Wireless Telephone is a WiFi telephone that runs using H.323.

- The availability of [VCM \(Voice Compression Module\)](#)<sup>[42]</sup> channels is necessary to support IP telephony. For IP Office 6.0+, these phones require an [Avaya IP Endpoints](#)<sup>[372]</sup> license.



The 3641 supports the following features:

- Lightweight innovative design .
- Simple to use.
- 802.11a, 802.11b and 802.11g standard-compatible.
- Transmission type Direct Sequence Spread Spectrum (DSSS).
- FCC certification Part 15.247.
- Management of telephones via DHCP and TFTP.
- Voice encoding G711.
- Wired Equivalent Privacy (WEP) - 40bit and 128 bit. WPA-PSK, WPA2-PSK.
- 5x16 character alphanumeric, plus status indicators.
- 4 hours talk time and 80 hours standby. Extendable with optional battery packs to 8 hours talk time and 160 hours standby.

---

## 12.9.16 3645

The Avaya 3645 IP Wireless Telephone is a WiFi telephone that runs using H.323.

- The availability of [VCM \(Voice Compression Module\)](#)<sup>[42]</sup> channels is necessary to support IP telephony. For IP Office 6.0+, these phones require an [Avaya IP Endpoints](#)<sup>[372]</sup> license.



The 3645 supports the following features:

- Lightweight innovative design .
- Simple to use.
- 802.11a, 802.11b and 802.11g standard-compatible.
- Transmission type Direct Sequence Spread Spectrum (DSSS).
- FCC certification Part 15.247.
- Management of telephones via DHCP and TFTP.
- Voice encoding G711.
- Wired Equivalent Privacy (WEP) - 40bit and 128 bit. WPA-PSK, WPA2-PSK.
- 5x16 character alphanumeric, plus status indicators.
- 4 hours talk time and 80 hours standby. Extendable with optional battery packs to 8 hours talk time and 160 hours standby.
- Can be enabled for Push-to-talk (walkie-talkie) feature for broadcast between employees.

**12.9.17 3701**

The 3701 is an Avaya DECT handset supported on IP Office when using Avaya IP DECT base stations.

<b>3701</b>	<b>Feature</b>	<b>Detail</b>
	<b>Connects via</b>	IP network
	<b>IP Office Release</b>	3.1+
	<b>Programmable Buttons</b>	✗
	<b>Headset Socket</b>	✗
	<b>Handsfree Speaker/Microphone</b>	✓/✗
	<b>Message Waiting Lamp</b>	✓
	<b>Upgradable Firmware</b>	✓

<b>Variant</b>	<b>SAP Code</b>	
3701	700346802	
Belt Clip	700346885	
Phone Charger	700346828	
Power Adaptor for Charger	European	700346836
	UK	700346844
	Australia	700378318
8-Phone Gang Charger	700346851	
Power Adaptor for Rack Mount Charger	Global	700346869

## 12.9.18 3711

The 3711 is an Avaya DECT handset supported on IP Office when using Avaya IP DECT base stations.

3711	Feature	Detail
	Connects via	IP network
	IP Office Release	3.1+
	Programmable Buttons	✗
	Headset Socket	✓
	Handsfree Speaker/Microphone	✓/✓
	Message Waiting Lamp	✓
	Upgradable Firmware	✓

Variant	SAP Code	
3711	700346810	
Belt Clip	700346885	
Phone Charger	700346828	
Power Adaptor for Charger	European	700346836
	UK	700346844
	Australia	700378318
8-Phone Gang Charger	700346851	
Power Adaptor for Rack Mount Charger	Global	700346869



## 12.9.19 3720

This DECT handset is supported with Avaya DECT R4 on IP Office Release 5 and higher.

- The availability of [VCM \(Voice Compression Module\)](#)<sup>[42]</sup> channels is necessary to support IP telephony. For IP Office 6.0+, these phones require an [Avaya IP Endpoints](#)<sup>[372]</sup> license.



---

## 12.9.20 3725

This DECT handset is supported with Avaya DECT R4 on IP Office Release 5 and higher.

- The availability of [VCM \(Voice Compression Module\)](#)<sup>[42]</sup> channels is necessary to support IP telephony. For IP Office 6.0+, these phones require an [Avaya IP Endpoints](#)<sup>[372]</sup> license.



## 12.9.21 3740

The 3740 is supported with Avaya DECT R4 systems and IP Office Release 7.0 and higher.

- The availability of [VCM \(Voice Compression Module\)](#)<sup>[42]</sup> channels is necessary to support IP telephony. For IP Office 6.0+, these phones require an [Avaya IP Endpoints](#)<sup>[37]</sup> license.



---

## 12.9.22 3749

The 3746 is a ruggedized DECT handset. It is supported with Avaya DECT R4 systems and IP Office Release 7.0 and higher.

- The availability of [VCM \(Voice Compression Module\)](#)<sup>[42]</sup> channels is necessary to support IP telephony. For IP Office 6.0+, these phones require an [Avaya IP Endpoints](#)<sup>[37]</sup> license.



**12.9.23 3810**

The phone uses a wireless 900MHz digital protocol to connect to its base station. The base station connects to an IP Office DS port. The base station also requires a power outlet socket. Additional power outlet sockets are required for the phone charger.

This phone is supported in North America (U-Law) only. Not supported on control unit base cards.

Depending on coverage overlap, between three and five 3810s can be connected to the same IP Office.

3810	Feature	Detail
	<b>Connects via</b>	DS port.
	<b>IP Office Release</b>	2.1+
	<b>Programmable Buttons</b>	✓ 4.
	<b>Headset Socket</b>	✓
	<b>Handsfree Speaker/ Microphone</b>	✓/✓
	<b>Message Waiting Lamp</b>	✓
	<b>Upgradable Firmware</b>	✗

Item	SAP Code
3810 Set - Includes phone, base station, charger, belt clip and power supply units for charger and base station.	700305105

---

### 12.9.24 3910

This single station DECT phone is supported on an IP500 V2 control unit running in Partner Edition mode. The base station uses an ETR port for connection to the IP Office. This phone is no longer available from Avaya and has been superseded by the [3920](#) <sup>[270]</sup>.



### 12.9.25 3920

This single station DECT phone is supported on an IP500 V2 control unit running in Partner Edition mode. The base station uses an ETR port for connection to the IP Office.



## 12.9.26 4406

This phone is supported in North America (U-Law) only. Not supported on control unit base cards.

4406D+	Feature	Detail
	Connects via	DS port.
	IP Office Release	1.0+
	Programmable Buttons	✓ 6 
	Headset Socket	✓
	Handsfree Speaker/Microphone	✓/ ✓
	Message Waiting Lamp	✓
	Display	16 characters x 2 lines.
	Supported Add-Ons	None.
	Upgradable Firmware	✗

## Standard DCP Phone Keys

✓  SPEAKER	✗  HEADSET	✓  MUTE	✓  VOLUME UP
✗  MESSAGES	✓  HOLD	✓  TRANSFER	✓  VOLUME DOWN
✗  DROP	✓  REDIAL	✓  CONFERENCE	











Item	SAP Code
4406D+ (Black)	108199027
4406D+ (White)	108199019
Small 4400 Series Stand (Black)	108541194
Stand 4400 Series Stand (White)	108541202

## 12.9.27 4412

This phone is supported in North America (U-Law) only. Not supported on control unit base cards.

Note: A maximum of twenty-seven of these telephones are supported on the IP500 DS30 expansion modules module at PCS level 5. Earlier expansion modules only support sixteen of these telephones.

4412D+	Feature	Detail
	Connects via	DS port.
	IP Office Release	1.0+
	Programmable Buttons	✓ 24 (12  /12  ).
	Headset Socket	✓
	Handsfree Speaker/ Microphone	✓/✓
	Message Waiting Lamp	✓
	Display	24 characters x 2 lines.
	Supported Add-Ons	<a href="#">4450</a> <sup>[327]</sup> x 2.
	Upgradable Firmware	✗

Standard DCP Phone Keys			
✓  SPEAKER	✗  HEADSET	✓  MUTE	✓  VOLUME UP
✗  MESSAGES	✓  HOLD	✓  TRANSFER	✓  VOLUME DOWN
✗  DROP	✓  REDIAL	✓  CONFERENCE	

Item		SAP Code
4412D+	Black	108199050
	White	108199043
Large 4400 Series Stand for 4412D+/4424D+	Black	108541269
	White	108541277





**12.9.28 4424**

This phone is supported in North America (U-Law) only. Not supported on control unit base cards.

Note: A maximum of twenty-seven of these telephones are supported on the IP500 DS30 expansion modules module at PCS level 5. Earlier expansion modules only support sixteen of these telephones.

4424D+	Feature	Detail
	Connects via	DS ports.
	IP Office Release	1.0+
	Programmable Buttons	✓ 24  .
	Headset Socket	✓
	Handsfree Speaker/Microphone	✓/✓
	Message Waiting Lamp	✓
	Display	24 characters x 2 lines.
	Supported Add-Ons	<a href="#">4450</a>  x 2.
	Upgradeable Firmware	✗

Standard DCP Phone Keys			
✓  SPEAKER	✗  HEADSET	✓  MUTE	✓  VOLUME UP
✗  MESSAGES	✓  HOLD	✓  TRANSFER	✓  VOLUME DOWN
✗  DROP	✓  REDIAL	✓  CONFERENCE	

Item		SAP Code
4424D+	Black	108199084
	White	108199076
Large 4400 Series Stand for 4412D+/4424D+	Black	108541269
	White	108541277
4450 DSS Add-On	Black	108199696
	White	108199407
Small 4400 Series Stand for 4450.	Black	108541194
	White	108541202
Power Supply for 4450		108596412

## 12.9.29 4601

This phone requires a separate power supply, using either a Avaya 1151D1 or 1151D2 power supply unit and power cord or an 802.3af Power over Ethernet (PoE) source. For RoHS compliance the 4601 has been replaced by the 4601+, however the two phones are functionally the same.

- The availability of [VCM \(Voice Compression Module\)](#)<sup>[42]</sup> channels is necessary to support IP telephony. For IP Office 6.0+, these phones require an [Avaya IP Endpoints](#)<sup>[372]</sup> license.

4601+	Feature	Detail
	<b>Connects via</b>	IP Network.
	<b>IP Office Release</b>	3.0+
	<b>Programmable Buttons</b>	✓ 2
	<b>Headset Socket</b>	✗
	<b>Handsfree Speaker/Microphone</b>	✗/✗
	<b>Message Waiting Lamp</b>	✓
	<b>PoE Class/Typical Idle Power Consumption</b>	3.5W (Class 2)
	<b>Display</b>	None.
	<b>Supported Add-Ons</b>	None.
	<b>Upgradeable Firmware</b>	✓
	<b>PC Pass-Through Port/with Voice Priority</b>	✗/✗

### Standard DCP Phone Keys

✗  SPEAKER	✗  HEADSET	✓  MUTE	✓  VOLUME UP
✓  MESSAGES	✓  HOLD	✓  TRANSFER	✓  VOLUME DOWN
✓  DROP	✓  REDIAL	✓  CONFERENCE	

Variant		SAP Code
4601+	Multi-Grey	700381890
1151D1 Power Supply	With CAT5 cable.	700434897
1151D2 Power Supply with battery backup.	With CAT5 cable.	700434905
1151D1/1151D2 Power Cord	USA	405362641
	Europe	407786623
	Australia and New Zealand	407786631
	India	407790991
	United Kingdom	407786599
	Argentina	408161453
Replacement Handset	Dark Grey	700203797
Amplified Handset	Dark Grey	700229735
Noisy Location Handset	Dark Grey	700229743
Push to Talk Handset	Dark Grey	700229727



## 12.9.30 4602



These phones are similar in physical appearance and functions. However the 4602SW+ includes a PC data pass-through port which gives priority to phone traffic. The 4602IP is no longer available from Avaya.

The 4602SW+ is the RoHS compliant replacement for the 4602SW which is no longer available.

This phone requires a separate power supply, using either a Avaya 1151D1 or 1151D2 power supply unit and power cord or a 802.3af Power over Ethernet (PoE) source.

- The availability of [VCM \(Voice Compression Module\)](#)<sup>[42]</sup> channels is necessary to support IP telephony. For IP Office 6.0+, these phones require an [Avaya IP Endpoints](#)<sup>[372]</sup> license.

4602/4602SW	Feature	4602IP	4602SW+
	<b>Connects via</b>	IP network.	
	<b>IP Office Release</b>	1.3+	
	<b>Programmable Buttons</b>	✓ 2   *	
	<b>Headset Socket</b>	✗	
	<b>Handsfree Speaker/Microphone</b>	✓/✗	
	<b>Message Waiting Lamp</b>	✓	
	<b>PoE Class/Typical Idle Power Consumption</b>	3.5W (Class 2)	
	<b>Display</b>	24 characters x 2 lines.	
	<b>Supported Add-Ons</b>	None.	
	<b>Upgradable Firmware</b>	✓	
	<b>PC Pass-Through Port/with Voice Priority</b>	✗/✗	✓/✓

Standard DCP Phone Keys			
✗  SPEAKER	✗  HEADSET	✓  MUTE	✓  VOLUME UP
✓  MESSAGES	✓  HOLD	✓  TRANSFER	✓  VOLUME DOWN
✓  DROP	✓  REDIAL	✓  CONFERENCE	

Variant		SAP Code
4602IP	Multi-Grey	700221260
4602SW+	Multi-Grey	700381916
1151D1 Power Supply	With CAT5 cable.	700434897
1151D2 Power Supply with battery backup.	With CAT5 cable.	700434905
1151D1/1151D2 Power Cord	USA	405362641
	Europe	407786623
	Australia and New Zealand	407786631
	India	407790991
	United Kingdom	407786599
	Argentina	408161453
	Replacement Handset	Dark Grey
Amplified Handset	Dark Grey	700229735
Noisy Location Handset	Dark Grey	700229743
Push to Talk Handset	Dark Grey	700229727

## 12.9.31 4610

This phone requires a separate power supply, using either a Avaya 1151D1 or 1151D2 power supply unit and power cord or a 802.3af Power over Ethernet (PoE) source.

- The availability of [VCM \(Voice Compression Module\)](#)<sup>[42]</sup> channels is necessary to support IP telephony. For IP Office 6.0+, these phones require an [Avaya IP Endpoints](#)<sup>[37]</sup> license.

4610SW	Feature	Detail
	<b>Connects via</b>	IP network.
	<b>IP Office Release</b>	3.0+
	<b>Programmable Buttons</b>	✓ 24 (6 buttons x 4pages).
	<b>Headset Socket</b>	✓
	<b>Handsfree Speaker/Microphone</b>	✓/✓.
	<b>Message Waiting Lamp</b>	✓
	<b>PoE Class/Typical Idle Power Consumption</b>	4.0W (Class 2)
	<b>Display</b>	29 characters x 5 lines (168 x 80 pixels)
	<b>Supported Add-Ons</b>	None.
	<b>Upgradable Firmware</b>	✓
	<b>PC Pass-Through Port/with Voice Priority</b>	✓/✓

Standard DCP Phone Keys			
✓  SPEAKER	✓  HEADSET	✓  MUTE	✓  VOLUME UP
✗  MESSAGES	✓  HOLD	✓  TRANSFER	✓  VOLUME DOWN
✓  DROP	✓  REDIAL	✓  CONFERENCE	

Variant	SAP Code	
4610SW	Multi-Grey	700381957
1151D1 Power Supply	With CAT5 cable.	700434897
1151D2 Power Supply with battery backup.	With CAT5 cable.	700434905
1151D1/1151D2 Power Cord.	USA	405362641
	Europe	407786623
	Australia and New Zealand	407786631
	India	407790991
	United Kingdom	407786599
	Argentina	408161453
Replacement Handset	Dark Grey	700203797
Amplified Handset	Dark Grey	700229735
Noisy Location Handset	Dark Grey	700229743
Push to Talk Handset	Dark Grey	700229727

## 12.9.32 4620







These phones are similar in physical appearance and functions. However the 4620SW's PC data pass-through port gives priority to phone traffic.

This phone requires a separate power supply, using either a Avaya 1151D1 or 1151D2 power supply unit and power cord or a 802.3af Power over Ethernet (PoE) source.

- The availability of [VCM \(Voice Compression Module\)](#)<sup>[42]</sup> channels is necessary to support IP telephony. For IP Office 6.0+, these phones require an [Avaya IP Endpoints](#)<sup>[372]</sup> license.

4620IP/4620SW	Feature	4620IP	4620SW
	<b>Connects via</b>	IP network.	
	<b>IP Office Release</b>	2.0+	
	<b>Programmable Buttons</b>	✓ 24 (12 buttons x 2 pages).	
	<b>Headset Socket</b>	✓	
	<b>Handsfree Speaker/Microphone</b>	✓/✓	
	<b>Message Waiting Lamp</b>	✓	
	<b>PoE Class/Typical Idle Power Consumption</b>	4W (Class 3)	5.9W (Class 3)
	<b>Display</b>	29 characters x 7 lines (168 x 132 pixels)	
	<b>Supported Add-Ons</b>	EU24*, EU24BL*.	
	<b>Upgradeable Firmware</b>	✓	
	<b>PC Pass-Through Port/with Voice Priority</b>	✓/✗	✓/✓

### Standard DCP Phone Keys

✓  SPEAKER	✓  HEADSET	✓  MUTE	✓  VOLUME UP
✗  MESSAGES	✓  HOLD	✓  TRANSFER	✓  VOLUME DOWN
✓  DROP	✓  REDIAL	✓  CONFERENCE	

Variant		SAP Code
4620IP	Multi-Grey	700212186
4620SW	Multi-Grey	700259674
Replacement Handset	Dark Grey	700203797
Amplified Handset	Dark Grey	700229735
Noisy Location Handset	Dark Grey	700229743
Push to Talk Handset	Dark Grey	700229727
EU24	Multi-Grey	700381817
EU24BL	Multi-Grey	700381544
1151D1 Power Supply	With CAT5 cable.	700434897
1151D2 Power Supply with battery backup.	With CAT5 cable.	700434905
1151D1/1151D2 Power Cord	USA	405362641
	Europe	407786623
	Australia/New Zealand	407786631
	India	407790991
	United Kingdom	407786599
	Argentina	408161453

\*When used with an EU24 or EU24BL unit, a 1151 type power supply unit must be used to power the phone.

## 12.9.33 4621

The 4621 is similar in physical appearance and function to the 4620SW. However the 4621SW includes a backlight function for the screen.

This phone requires a separate power supply, using either a Avaya 1151D1 or 1151D2 power supply unit and power cord or a 802.3af Power over Ethernet (PoE) source.

- The availability of [VCM \(Voice Compression Module\)](#)<sup>[42]</sup> channels is necessary to support IP telephony. For IP Office 6.0+, these phones require an [Avaya IP Endpoints](#)<sup>[372]</sup> license.

4621SW	Feature	4621SW
	<b>Connects via</b>	IP network.
	<b>IP Office Release</b>	3.0(577)+
	<b>Programmable Buttons</b>	✓ 24 (12 buttons x 2 pages).
	<b>Headset Socket</b>	✓
	<b>Handsfree Speaker/Microphone</b>	✓/✓
	<b>Message Waiting Lamp</b>	✓
	<b>PoE Class/Typical Idle Power Consumption</b>	5.75W (Class 2)
	<b>Display</b>	29 characters x 7 lines (168 x 132 pixels)
	<b>Supported Add-Ons</b>	EU24*, EU24BL*.
	<b>Upgradeable Firmware</b>	✓
	<b>PC Pass-Through Port/with Voice Priority</b>	✓/✓

Standard DCP Phone Keys			
✓  SPEAKER	✓  HEADSET	✓  MUTE	✓  VOLUME UP
✗  MESSAGES	✓  HOLD	✓  TRANSFER	✓  VOLUME DOWN
✓  DROP	✓  REDIAL	✓  CONFERENCE	

Variant		SAP Code
4621SW	Multi-Grey	700345192
Replacement Handset	Dark Grey	700203797
Amplified Handset	Dark Grey	700229735
Noisy Location Handset	Dark Grey	700229743
Push to Talk Handset	Dark Grey	700229727
EU24*	Multi-Grey	700381817
EU24BL*	Multi-Grey	700381544
1151D1 Power Supply	With CAT5 cable.	700434897
1151D2 Power Supply with battery backup.	With CAT5 cable.	700434905
1151D1/1151D2 Power Cord	USA	405362641
	Europe	407786623
	Australia/New Zealand	407786631
	India	407790991
	United Kingdom	407786599
	Argentina	408161453

\*When used with an EU24 or EU24BL unit, a 1151 type power supply unit must be used to power the phone.

## 12.9.34 4625

The 4625 is similar in physical appearance and function to the 4621SW. However the 4625SW includes a color display.

This phone requires a separate power supply, using either a Avaya 1151D1 or 1151D2 power supply unit and power cord or a 802.3af Power over Ethernet (PoE) source.

- The availability of [VCM \(Voice Compression Module\)](#)<sup>[42]</sup> channels is necessary to support IP telephony. For IP Office 6.0+, these phones require an [Avaya IP Endpoints](#)<sup>[37]</sup> license.

4625SW	Feature	4625SW
	<b>Connects via</b>	IP network.
	<b>IP Office Release</b>	3.2+
	<b>Programmable Buttons</b>	✓ 24 (12 buttons x 2 pages).
	<b>Headset Socket</b>	✓
	<b>Handsfree Speaker/Microphone</b>	✓/✓
	<b>Message Waiting Lamp</b>	✓
	<b>PoE Class/Typical Idle Power Consumption</b>	6.45W (Class 3)
	<b>Display</b>	29 characters x 7 lines (168 x 132 pixels)
	<b>Supported Add-Ons</b>	EU24*, EU24BL*.
	<b>Upgradeable Firmware</b>	✓
<b>PC Pass-Through Port/with Voice Priority</b>	✓/✓	

Standard DCP Phone Keys			
✓  SPEAKER	✓  HEADSET	✓  MUTE	✓  VOLUME UP
✗  MESSAGES	✓  HOLD	✓  TRANSFER	✓  VOLUME DOWN
✓  DROP	✓  REDIAL	✓  CONFERENCE	

Variant		SAP Code
4625SW	Multi-Grey	700381551
Replacement Handset	Dark Grey	700203797
Amplified Handset	Dark Grey	700229735
Noisy Location Handset	Dark Grey	700229743
Push to Talk Handset	Dark Grey	700229727
EU24*	Multi-Grey	700381817
EU24BL*	Multi-Grey	700381544
1151D1 Power Supply	With CAT5 cable.	700434897
1151D2 Power Supply with battery backup.	With CAT5 cable.	700434905
1151D1/1151D2 Power Cord	USA	405362641
	Europe	407786623
	Australia/New Zealand	407786631
	India	407790991
	United Kingdom	407786599
	Argentina	408161453











\*When used with an EU24 or EU24BL unit, a 1151 type power supply unit must be used to power the phone.

## 12.9.35 5402

This phone is similar in physical appearance and functions to the 2402D. However the 5402 phone is only supported on IP Office.

In addition to the two physical programmable buttons, the  FEATURE key plus 0-9, \* and # can be used to access an addition 12 programmable slots.

5402	Feature	Detail
	<b>Connects via</b>	DS port.
	<b>IP Office Release</b>	3.0+.
	<b>Programmable Buttons</b>	✓ 2   *.
	<b>Headset Socket</b>	✗
	<b>Handsfree Speaker/Microphone</b>	✓/✗
	<b>Message Waiting Lamp</b>	✓
	<b>Display</b>	24 characters x 2 lines.
	<b>Supported Add-Ons</b>	None.
	<b>Upgradable Firmware</b>	✓

Standard DCP Phone Keys			
✗  SPEAKER	✗  HEADSET	✓  MUTE	✓  VOLUME UP
✓  MESSAGES	✓  HOLD	✓  TRANSFER	✓  VOLUME DOWN
✓  DROP	✓  REDIAL	✓  CONFERENCE	

Variant		SAP Code
5402	Multi-Grey	700345309
Replacement Handset	Dark Grey	700203797
Amplified Handset	Dark Grey	700229735
Noisy Location Handset	Dark Grey	700229743
Push to Talk Handset	Dark Grey	700229727



## 12.9.36 5410

This phone is similar in physical appearance and functions to the 2410. However the 5410 phone is only supported on IP Office.

5410	Feature	Detail
	Connects via	DS port.
	IP Office Release	3.0+
	Programmable Buttons	✓ 12 (6 buttons x 2 pages).
	Headset Socket	✓
	Handsfree Speaker/ Microphone	✓/✓
	Message Waiting Lamp	✓
	Display	29 characters x 5 lines. (168 x 80 pixels).
	Supported Add-Ons	None.
	Upgradable Firmware	✓











Standard DCP Phone Keys			
✓  SPEAKER	✓  HEADSET	✓  MUTE	✓  VOLUME UP
✓  MESSAGES	✓  HOLD	✓  TRANSFER	✓  VOLUME DOWN
✓  DROP	✓  REDIAL	✓  CONFERENCE	

Variant		SAP Code
5410	Multi-Grey	700345291
5410 (RoHS compliant)	Multi-Grey	700382005
Replacement Handset	Dark Grey	700203797
Amplified Handset	Dark Grey	700229735
Noisy Location Handset	Dark Grey	700229743
Push to Talk Handset	Dark Grey	700229727

## 12.9.37 5420

This phone is similar in physical appearance and functions to the 2420. However the 5420 is only supported on IP Office.

5420D	Feature	Detail
	<b>Connects via</b>	DS port.
	<b>IP Office Release</b>	3.0+
	<b>Programmable Buttons</b>	✓ 24 (8 buttons x 3 pages)
	<b>Headset Socket</b>	✓
	<b>Handsfree Speaker/Microphone</b>	✓/✓
	<b>Message Waiting Lamp</b>	✓
	<b>Display</b>	29 characters x 7 lines.
	<b>Supported Add-Ons</b>	EU24*, 201B.
	<b>Upgradable Firmware</b>	✓

Standard DCP Phone Keys			
✓  SPEAKER	✓  HEADSET	✓  MUTE	✓  VOLUME UP
✓  MESSAGES	✓  HOLD	✓  TRANSFER	✓  VOLUME DOWN
✓  DROP	✓  REDIAL	✓  CONFERENCE	

Variant		SAP Code
5420D	Multi-Grey	700339823
5420D (RoHS compliant)	Multi-Grey	700381627
Replacement Handset	Dark Grey	700203797
Amplified Handset	Dark Grey	700229735
Noisy Location Handset	Dark Grey	700229743
Push to Talk Handset	Dark Grey	700229727
201B Recorder Interface Module		700381635
20B Stand		700381650
EU24*	Multi-Grey	700381817
1151D1 Power Supply	With CAT5 cable.	700434897
1151D2 Power Supply with battery backup.	With CAT5 cable.	700434905
1151D1/1151D2 Power Cord	USA	405362641
	Europe	407786623
	Australia/New Zealand	407786631
	India	407790991
	United Kingdom	407786599
	Argentina	408161453

\*When used with an EU24 unit, a 1151 type power supply unit must be used to power the phone.

## 12.9.38 5601

This phone is similar in physical appearance and functions to the 4601. However the 5601 phone is only supported on IP Office. The 5601+ is the RoHS compliant version that has replaced the previous 5601 IP model but is otherwise the same.

This phone requires a separate power supply, using either a Avaya 1151D1 or 1151D2 power supply unit and power cord or a 802.3af Power over Ethernet (PoE) source.

- The availability of [VCM \(Voice Compression Module\)](#)<sup>[42]</sup> channels is necessary to support IP telephony. For IP Office 6.0+, these phones require an [Avaya IP Endpoints](#)<sup>[372]</sup> license.

5601	Feature	Detail
	<b>Connects via</b>	IP Network.
	<b>IP Office Release</b>	3.0+
	<b>Programmable Buttons</b>	✓ 2
	<b>Headset Socket</b>	✗
	<b>Handsfree Speaker/Microphone</b>	✗/✗
	<b>Message Waiting Lamp</b>	✓
	<b>PoE Class/Typical Idle Power Consumption</b>	3.5W (Class 2)
	<b>Display</b>	None.
	<b>Supported Add-Ons</b>	None.
	<b>Upgradeable Firmware</b>	✓
	<b>PC Pass-Through Port/with Voice Priority</b>	✗/✗

Standard DCP Phone Keys			
✗  SPEAKER	✗  HEADSET	✓  MUTE	✓  VOLUME UP
✓  MESSAGES	✓  HOLD	✓  TRANSFER	✓  VOLUME DOWN
✓  DROP	✓  REDIAL	✓  CONFERENCE	

Variant		SAP Code
5601IP	Multi-Grey	700345366
5601+ (RoHS compliant)	Multi-Grey	700381908
Replacement Handset	Dark Grey	700203797
Amplified Handset	Dark Grey	700229735
Noisy Location Handset	Dark Grey	700229743
Push to Talk Handset	Dark Grey	700229727
1151D1 Power Supply	With CAT5 cable.	700434897
1151D2 Power Supply with battery backup.	With CAT5 cable.	700434905
1151D1/1151D2 Power Cord	USA	405362641
	Europe	407786623
	Australia/New Zealand	407786631
	India	407790991
	United Kingdom	407786599
	Argentina	408161453

## 12.9.39 5602

The 5602IP and 5602SW phones are similar in physical appearance and functions. However the 5602SW includes a PC data pass-through port which gives priority to phone traffic. The 5602IP is no longer available from Avaya. The 5602SW+ is the RoHS compliant version that has replaced the previous 5602SW model but is otherwise the same.

This phone requires a separate power supply, using either a Avaya 1151D1 or 1151D2 power supply unit and power cord or a 802.3af Power over Ethernet (PoE) source.

- The availability of [VCM \(Voice Compression Module\)](#)<sup>[42]</sup> channels is necessary to support IP telephony. For IP Office 6.0+, these phones require an [Avaya IP Endpoints](#)<sup>[372]</sup> license.

5602IP/5602SW	Feature	5602IP	5602SW
	<b>Connects via</b>	IP network.	
	<b>IP Office Release</b>	3.0+	
	<b>Programmable Buttons</b>	✓ 2 ☐    * *	
	<b>Headset Socket</b>	✗	
	<b>Handsfree Speaker/Microphone</b>	✓/✗	
	<b>Message Waiting Lamp</b>	✓	
	<b>PoE Class/Typical Idle Power Consumption</b>	4.1W (Class 2)	
	<b>Display</b>	24 characters x 2 lines.	
	<b>Supported Add-Ons</b>	None.	
	<b>Upgradable Firmware</b>	✓	
	<b>PC Pass-Through Port/with Voice Priority</b>	✗/✗	✓/✓

Standard DCP Phone Keys			
✗  SPEAKER	✗  HEADSET	✓  MUTE	✓  VOLUME UP
✓  MESSAGES	✓  HOLD	✓  TRANSFER	✓  VOLUME DOWN
✓  DROP	✓  REDIAL	✓  CONFERENCE	











Variant		SAP Code
5602IP	Multi-Grey	700345341
5602SW	Multi-Grey	700381825
5602SW+ (RoHS compliant)	Multi-Grey	700381932
Replacement Handset	Dark Grey	700203797
Amplified Handset	Dark Grey	700229735
Noisy Location Handset	Dark Grey	700229743
Push to Talk Handset	Dark Grey	700229727
EU24	Multi-Grey	700381817
EU24BL	Multi-Grey	700381544
1151D1 Power Supply	With CAT5 cable.	700434897
1151D2 Power Supply with battery backup.	With CAT5 cable.	700434905
1151D1/1151D2 Power Cord	USA	405362641
	Europe	407786623
	Australia/New Zealand	407786631
	India	407790991
	United Kingdom	407786599
	Argentina	408161453

## 12.9.40 5610

This phone requires a separate power supply, using either a Avaya 1151D1 or 1151D2 power supply unit and power cord or a 802.3af Power over Ethernet (PoE) source.

- The availability of [VCM \(Voice Compression Module\)](#)<sup>[42]</sup> channels is necessary to support IP telephony. For IP Office 6.0+, these phones require an [Avaya IP Endpoints](#)<sup>[37]</sup> license.

5610	Feature	Detail
	<b>Connects via</b>	IP network.
	<b>IP Office Release</b>	3.0+
	<b>Programmable Buttons</b>	✓ 24 (6 buttons x 4 pages).
	<b>Headset Socket</b>	✓
	<b>Handsfree Speaker/Microphone</b>	✓/✓.
	<b>Message Waiting Lamp</b>	✓
	<b>PoE Class/Typical Idle Power Consumption</b>	5W (Class 2)
	<b>Display</b>	29 characters x 5 lines (168 x 80 pixels)
	<b>Supported Add-Ons</b>	None.
	<b>Upgradable Firmware</b>	✓
<b>PC Pass-Through Port/with Voice Priority</b>	✓/✓	

Standard DCP Phone Keys			
✓  SPEAKER	✓  HEADSET	✓  MUTE	✓  VOLUME UP
✗  MESSAGES	✓  HOLD	✓  TRANSFER	✓  VOLUME DOWN
✓  DROP	✓  REDIAL	✓  CONFERENCE	

Variant		SAP Code
5610SW	Multi-Grey	700345333
5610SW (RoHS compliant)	Multi-Grey	700381965
Replacement Handset	Dark Grey	700203797
Amplified Handset	Dark Grey	700229735
Noisy Location Handset	Dark Grey	700229743
Push to Talk Handset	Dark Grey	700229727
EU24	Multi-Grey	700381817
EU24BL	Multi-Grey	700381544
1151D1 Power Supply	With CAT5 cable.	700434897
1151D2 Power Supply with battery backup.	With CAT5 cable.	700434905
1151D1/1151D2 Power Cord	USA	405362641
	Europe	407786623
	Australia/New Zealand	407786631
	India	407790991
	United Kingdom	407786599
	Argentina	408161453

## 12.9.41 5620

This phone is similar in physical appearance and functions to the 4620SW. It is no longer available from Avaya, having been replaced by the 5621.

This phone requires a separate power supply, using either a Avaya 1151D1 or 1151D2 power supply unit and power cord or a 802.3af Power over Ethernet (PoE) source.

- The availability of [VCM \(Voice Compression Module\)](#)<sup>[42]</sup> channels is necessary to support IP telephony. For IP Office 6.0+, these phones require an [Avaya IP Endpoints](#)<sup>[372]</sup> license.

5620	Feature	5620IP
	<b>Connects via</b>	IP network.
	<b>IP Office Release</b>	3.0+
	<b>Programmable Buttons</b>	✓ 24 (12 buttons x 2 pages).
	<b>Headset Socket</b>	✓
	<b>Handsfree Speaker/Microphone</b>	✓/✓
	<b>Message Waiting Lamp</b>	✓
	<b>PoE Class/Typical Idle Power Consumption</b>	5.9W (Class 3)
	<b>Display</b>	29 characters x 7 lines (168 x 132 pixels)
	<b>Supported Add-Ons</b>	EU24*, EU24BL*.
	<b>Upgradeable Firmware</b>	✓
	<b>PC Pass-Through Port/with Voice Priority</b>	✓/✓

Standard DCP Phone Keys			
✓  SPEAKER	✓  HEADSET	✓  MUTE	✓  VOLUME UP
✗  MESSAGES	✓  HOLD	✓  TRANSFER	✓  VOLUME DOWN
✓  DROP	✓  REDIAL	✓  CONFERENCE	

Variant	SAP Code	
5620IP	Multi-Grey	700339815
Replacement Handset	Dark Grey	700203797
Amplified Handset	Dark Grey	700229735
Noisy Location Handset	Dark Grey	700229743
Push to Talk Handset	Dark Grey	700229727
EU24*	Multi-Grey	700381817
EU24BL*	Multi-Grey	700381544
1151D1 Power Supply	With CAT5 cable.	700434897
1151D2 Power Supply with battery backup.	With CAT5 cable.	700434905
1151D1/1151D2 Power Cord	USA	405362641
	Europe	407786623
	Australia/New Zealand	407786631
	India	407790991
	United Kingdom	407786599
	Argentina	408161453

\*When used with an EU24 or EU24BL unit, a 1151 type power supply unit must be used to power the phone.











## 12.9.42 5621

This phone is similar in physical appearance and functions to the 4621SW.

This phone requires a separate power supply, using either a Avaya 1151D1 or 1151D2 power supply unit and power cord or a 802.3af Power over Ethernet (PoE) source.

- The availability of [VCM \(Voice Compression Module\)](#)<sup>[42]</sup> channels is necessary to support IP telephony. For IP Office 6.0+, these phones require an [Avaya IP Endpoints](#)<sup>[37]</sup> license.

5621	Feature	5620IP
	<b>Connects via</b>	IP network.
	<b>IP Office Release</b>	3.2+
	<b>Programmable Buttons</b>	✓ 24 (12 buttons x 2 pages).
	<b>Headset Socket</b>	✓
	<b>Handsfree Speaker/Microphone</b>	✓/✓
	<b>Message Waiting Lamp</b>	✓
	<b>PoE Class/Typical Idle Power Consumption</b>	5.9W (Class 3)
	<b>Display</b>	29 characters x 7 lines (168 x 132 pixels)
	<b>Supported Add-Ons</b>	EU24*, EU24BL*.
	<b>Upgradeable Firmware</b>	✓
	<b>PC Pass-Through Port/with Voice Priority</b>	✓/✓

Standard DCP Phone Keys			
✓  SPEAKER	✓  HEADSET	✓  MUTE	✓  VOLUME UP
✗  MESSAGES	✓  HOLD	✓  TRANSFER	✓  VOLUME DOWN
✓  DROP	✓  REDIAL	✓  CONFERENCE	

Variant		SAP Code
5621SW	Multi-Grey	700345982
5621SW (RoHS compliant)	Multi-Grey	700385982
Replacement Handset	Dark Grey	700203797
Amplified Handset	Dark Grey	700229735
Noisy Location Handset	Dark Grey	700229743
Push to Talk Handset	Dark Grey	700229727
EU24*	Multi-Grey	700381817
EU24BL*	Multi-Grey	700381544
1151D1 Power Supply	With CAT5 cable.	700434897
1151D2 Power Supply with battery backup.	With CAT5 cable.	700434905
1151D1/1151D2 Power Cord	USA	405362641
	Europe	407786623
	Australia/New Zealand	407786631
	India	407790991
	United Kingdom	407786599
	Argentina	408161453

\*When used with an EU24 or EU24BL unit, a 1151 type power supply unit must be used to power the phone.

---

## 12.9.43 9504

9500 Series phones are supported by IP Office Release 7.0 and higher.

The phones provide 4 physical buttons with red and green LEDs. These can be used for up to 12 programmable features.



Variant		SAP Code
9504 Telephone	Charcoal Grey	700500206
BM12 Button Module	Charcoal Grey	700480643



## 12.9.44 9508

9500 Series phones are supported by IP Office Release 7.0 and higher.

The phones provide 8 physical buttons with red and green LEDs. These can be used for up to 24 programmable features. The phones support the addition of up to 3 BM12 button modules supporting an additional 24 programmable features (using 12 buttons) per module.



Variant		SAP Code
9508 Telephone	Charcoal Grey	700500207
BM12 Button Module	Charcoal Grey	700480643

---

## 12.9.45 9608, 9608G

- This phone is supported by the IP Office Release 8.0 Q1 2012 Service Pack and higher. The voice activated dialing and USB features are not supported.
- The previous restrictions against using the IP Office system as the HTTP file server for this type of phone have been removed.
- GLOBAL models do not include text labels under the buttons.

The phone supports 24 programmable buttons. These can be used for call appearance functions and other IP Office features. The phone is available with or without Gigabit support.

This phone can be used with up to 3 x BM12 or 3 x SBM24 button modules. Each module provides an additional 24 programmable buttons. Attaching button modules requires the phone to be powered as a Class 3 device by setting its power switch to the **H** position. If not being powered by PoE, these telephones use an Avaya Single Port PoE injector (SPPOE-xx).



Variant		SAP Code
9608 Telephone	Charcoal Grey	700480585
9608 IP Deskphone Global	Charcoal Grey	700504844
9608 IP Deskphone <a href="#">TAA</a> <sup>[388]</sup>	Charcoal Grey	700501428
9608 IP Deskphone <a href="#">TAA</a> <sup>[388]</sup> Global	Charcoal Grey	700507947
9608G IP Deskphone Global	Charcoal Grey	700505424
9608G IP Deskphone <a href="#">TAA</a> <sup>[388]</sup> Global	Charcoal Grey	700507946
9600 Gigabit Ethernet Adapter	-	700383771
BM12 Button Module	Charcoal Grey	700480643
9600 Dual Headset Adapter	Charcoal Grey	700503227
PoE Power Injector		SAP Code
Single Port PoE Injector (SPPOE-1A)	-	700500725
" US Power Cord	-	405362641
" European Power Cord	-	407786623
" UK Power Cord	-	407786599
" Australian Power Cord	-	407786631
" Indian Power Cord	-	407790591
" Argentina Power Cord	-	408161453
" Japanese Power Cord	-	700405681
Stands and Wall Mounts		SAP Code
9400/9500/9608/9611/9620 Wall Mount	-	700383375
9621/9630/9640/9641 Wall Mount	-	700383383
9608/9611 Replacement Stand	-	700500726
9621/9630/9640/9641 Stand	-	700416563
BM12 Replacement Stand	-	700500727
SBM24 Replacement Stand	-	700416571
9621/9630/9640/9641 Wedge Stand	-	700383888
Handset and Cables		
9600 Ethernet Cable	3 metres	700383326
9600 Handset	Charcoal Grey	700416548
9600 Amplified Handset	Charcoal Grey	700446370
9600 Handset Cord 9ft	Charcoal Grey	700383318
9600 Handset Cord 25ft	Charcoal Grey	700383821

---

## 12.9.46 9611G

- This phone is supported by the IP Office Release 8.0 Q1 2012 Service Pack and higher. The voice activated dialing and USB features are not supported.
- The previous restrictions against using the IP Office system as the HTTP file server for this type of phone have been removed.
- GLOBAL models do not include text labels under the buttons.

The phone supports 24 programmable buttons. These can be used for call appearance functions and other IP Office features.

This phone can be used with up to 3 x BM12 or 3 x SBM24 button modules. Each module provides an additional 24 programmable buttons. Attaching button modules requires the phone to be powered as a Class 3 device by setting its power switch to the **H** position. If not being powered by PoE, these telephones use an Avaya Single Port PoE injector (SPPOE-xx).



Variant		SAP Code
9611G IP Deskphone	Charcoal Grey	700480593
9611G IP Deskphone Global	Charcoal Grey	700507945
9611G IP Deskphone <a href="#">TAA</a> <sup>[388]</sup>	Charcoal Grey	700501429
9611G IP Deskphone <a href="#">TAA</a> <sup>[388]</sup> Global	Charcoal Grey	700507948
BM12 Button Module	Charcoal Grey	700480643
Dual Headset Adapter	Charcoal Grey	700503227
PoE Power Injector		SAP Code
Single Port PoE Injector (SPPOE-1A)	–	700500725
" US Power Cord	–	405362641
" European Power Cord	–	407786623
" UK Power Cord	–	407786599
" Australian Power Cord	–	407786631
" Indian Power Cord	–	407790591
" Argentina Power Cord	–	408161453
" Japanese Power Cord	–	700405681
Stands and Wall Mounts		SAP Code
9400/9500/9608/9611/9620 Wall Mount	–	700383375
9621/9630/9640/9641 Wall Mount	–	700383383
9608/9611 Replacement Stand	–	700500726
9621/9630/9640/9641 Stand	–	700416563
BM12 Replacement Stand	–	700500727
SBM24 Replacement Stand	–	700416571
9621/9630/9640/9641 Wedge Stand	–	700383888
Handset and Cables		
9600 Ethernet Cable	3 metres	700383326
9600 Handset	Charcoal Grey	700416548
9600 Amplified Handset	Charcoal Grey	700446370
9600 Handset Cord 9ft	Charcoal Grey	700383318
9600 Handset Cord 25ft	Charcoal Grey	700383821

## 12.9.47 9620L, 9620C

These phones are supported on IP500 V2 systems running IP Office Release 6.0 and higher. The phones are supplied with a two-position stand.

- The availability of [VCM \(Voice Compression Module\)](#)<sup>[42]</sup> channels is necessary to support IP telephony. For IP Office 6.0+, these phones require an [Avaya IP Endpoints](#)<sup>[37]</sup> license.
- The voice activated dialing and USB features are not supported.
- For IP Office Release 6.1, these phones are supported running SIP software. When that is the case, the IP Office or IP Office Manager should not be used as the file server for the phone. Avaya SIP phones require an Avaya IP Endpoints license.
- The Class requirement of PoE powered phones may be increased if the phone is used with additional equipment such as a button module.

9620	Feature	9620L	9620C
	<b>Connects via</b>	IP network.	IP network.
	<b>IP Office Release</b>	6.0+	6.0+
	<b>Programmable Buttons</b>	✓ Soft buttons.	✓ Soft buttons.
	<b>Headset Socket</b>	✓	✓
	<b>Handsfree Speaker/ Microphone</b>	✓/✓	✓/✓
	<b>Message Waiting Lamp</b>	✓	✓
	<b>PoE Class/Typical Idle Power Consumption</b>	Class 1	Class 1
	<b>Display</b>	1/4 VGA Greyscale	1/4 VGA Color
	<b>Supported Add-Ons</b>	-	-
	<b>Upgradeable Firmware</b>	✓	✓
<b>PC Pass-Through Port/with Voice Priority</b>	✓/✓	✓/✓	

### Fixed Function Keys

✓  SPEAKER	✓  HEADSET	✓  MUTE	✓  VOLUME UP	✓  CONTACTS
✓  MESSAGE	✗  HOLD	✗  TRANSFER	✓  VOLUME DOWN	✓  CALL LOG
✗  DROP	✗  REDIAL	✗  CONFERENCE	✓  MENU	✗  FORWARD

Functions for fixed functions keys not present are accessible through display menu soft key functions.

Variant		SAP Code
9620L Telephone	Charcoal Grey	700461197
9620C Telephone	Charcoal Grey	700461205
9620L without faceplate	-	700461239
9620C without faceplate	-	700461247
Replacement Stand	Silver	700416555
Wedge Stand	Charcoal Grey	700383870
Wall Mounting Plate	Charcoal Grey	700383375
9600 Gigabit Ethernet Adapter	-	700383771
Bluetooth Adapter	-	700383789
Replacement Handset	Charcoal Grey	700416548
Amplified Speech Handset	Charcoal Grey	700446370
Replacement Handset Cord (9 feet)	Charcoal Grey	700383318
Replacement Handset Cord (25 feet)	Charcoal Grey	700383821
Replacement Line Cord	Charcoal Grey	700383326

---

## 12.9.48 9621G

- This phone is supported by the IP Office Release 8.0 Q1 2012 Service Pack and higher. The voice activated dialing and USB features are not supported.
- The previous restrictions against using the IP Office system as the HTTP file server for this type of phone have been removed.
- GLOBAL models do not include text labels under the buttons.

The phones support 24 programmable buttons which are displayed as touchscreen options. These can be used for call appearance functions and other IP Office features. In addition the phone supports a home screen on which the user can add up to 8 icons for programmable functions in addition to those icons present through installation configuration.

These phones do not support any button modules.





Variant		SAP Code
9621G IP Deskphone	Charcoal Grey	700480601
9621G IP Deskphone Global	Charcoal Grey	700506514
9621G IP Deskphone <a href="#">TAA</a> <sup>[388]</sup>	Charcoal Grey	700500254
9621G IP Deskphone <a href="#">TAA</a> <sup>[388]</sup> Global	Charcoal Grey	700506516
PoE Power Injector		SAP Code
Single Port PoE Injector (SPPOE-1A)	–	700500725
" US Power Cord	–	405362641
" European Power Cord	–	407786623
" UK Power Cord	–	407786599
" Australian Power Cord	–	407786631
" Indian Power Cord	–	407790591
" Argentina Power Cord	–	408161453
" Japanese Power Cord	–	700405681
Stands and Wall Mounts		SAP Code
9400/9500/9608/9611/9620 Wall Mount	–	700383375
9621/9630/9640/9641 Wall Mount	–	700383383
9608/9611 Replacement Stand	–	700500726
9621/9630/9640/9641 Stand	–	700416563
BM12 Replacement Stand	–	700500727
SBM24 Replacement Stand	–	700416571
9621/9630/9640/9641 Wedge Stand	–	700383888
Handset and Cables		
9600 Ethernet Cable	3 metres	700383326
9600 Handset	Charcoal Grey	700416548
9600 Amplified Handset	Charcoal Grey	700446370
9600 Handset Cord 9ft	Charcoal Grey	700383318
9600 Handset Cord 25ft	Charcoal Grey	700383821

## 12.9.49 9630G

These phones are supported on IP500 V2 systems running IP Office Release 6.0 and higher. The phones are supplied with a two-position stand.

- The availability of [VCM \(Voice Compression Module\)](#)<sup>[42]</sup> channels is necessary to support IP telephony. For IP Office 6.0+, these phones require an [Avaya IP Endpoints](#)<sup>[37]</sup> license.
- The voice activated dialing and USB features are not supported.
- For IP Office Release 6.1, these phones are supported running SIP software. When that is the case, the IP Office or IP Office Manager should not be used as the file server for the phone. Avaya SIP phones require an Avaya IP Endpoints license.
- The Class requirement of PoE powered phones may be increased if the phone is used with additional equipment such as a button module.

9630	Feature	9630
	<b>Connects via</b>	IP network.
	<b>IP Office Release</b>	6.0+
	<b>Programmable Buttons</b>	✓
	<b>Headset Socket</b>	✓
	<b>Handsfree Speaker/Microphone</b>	✓/✓
	<b>Message Waiting Lamp</b>	✓
	<b>PoE Class/Typical Idle Power Consumption</b>	Class 2
	<b>Display</b>	1/3 VGA Greyscale
	<b>Supported Add-Ons</b>	<a href="#">SMB24</a> <sup>[33]</sup> x 3.
	<b>Upgradeable Firmware</b>	✓
	<b>PC Pass-Through Port/with Voice Priority</b>	✓/✓

### Fixed Function Keys

✓  SPEAKER	✓  HEADSET	✓  MUTE	✓  VOLUME UP	✓  CONTACTS
✓  MESSAGE	✗  HOLD	✗  TRANSFER	✓  VOLUME DOWN	✓  CALL LOG
✗  DROP	✗  REDIAL	✗  CONFERENCE	✓  MENU	✓  FORWARD

Functions for fixed functions keys not present are accessible through display menu soft key functions.

Variant		SAP Code
9630G Telephone	Charcoal Grey	700405673
9630G without faceplate	-	700408602
SMB24 Button Module	Charcoal Grey	700462518
SMB24 without faceplate	-	700462526
SMB24 Replacement Stand	Silver	700416571
Replacement Stand	Silver	700416563
Wedge Stand	Charcoal Grey	700383888
Wall Mounting Plate	Charcoal Grey	700383383
Gigabit Adapter	-	700383771
Bluetooth Adapter	-	700383789
Replacement Handset	Charcoal Grey	700416548
Amplified Speech Handset	Charcoal Grey	700446370
Replacement Handset Cord (9 feet)	Charcoal Grey	700383318
Replacement Handset Cord (25 feet)	Charcoal Grey	700383821
Replacement Line Cord	Charcoal Grey	700383326

## 12.9.50 9640, 9640G

These phones are supported on IP500 V2 systems running IP Office Release 6.0 and higher. The phones are supplied with a two-position stand.

- The availability of [VCM \(Voice Compression Module\)](#)<sup>[42]</sup> channels is necessary to support IP telephony. For IP Office 6.0+, these phones require an [Avaya IP Endpoints](#)<sup>[37]</sup> license.
- The voice activated dialing and USB features are not supported.
- For IP Office Release 6.1, these phones are supported running SIP software. When that is the case, the IP Office or IP Office Manager should not be used as the file server for the phone. Avaya SIP phones require an Avaya IP Endpoints license.
- The Class requirement of PoE powered phones may be increased if the phone is used with additional equipment such as a button module.

9640	Feature	9640
	<b>Connects via</b>	IP network.
	<b>IP Office Release</b>	6.0+
	<b>Programmable Buttons</b>	✓
	<b>Headset Socket</b>	✓
	<b>Handsfree Speaker/ Microphone</b>	✓/✓
	<b>Message Waiting Lamp</b>	✓
	<b>PoE Class/Typical Idle Power Consumption</b>	Class 2
	<b>Display</b>	1/3 VGA Greyscale
	<b>Supported Add-Ons</b>	<a href="#">SMB24</a> <sup>[33]</sup> x 3.
	<b>Upgradeable Firmware</b>	✓
<b>PC Pass-Through Port/ with Voice Priority</b>	✓/✓	

### Fixed Function Keys

✓  SPEAKER	✓  HEADSET	✓  MUTE	✓  VOLUME UP	✓  CONTACTS
✓  MESSAGE	✗  HOLD	✗  TRANSFER	✓  VOLUME DOWN	✓  CALL LOG
✗  DROP	✗  REDIAL	✗  CONFERENCE	✓  MENU	✓  FORWARD

Functions for fixed functions keys not present are accessible through display menu soft key functions.

Variant		SAP Code
9640 Telephone	Charcoal Grey	700383920
9640G Telephone	Charcoal Grey	700419195
9640 without faceplate	-	700408610
9640G without faceplate	-	700429095
SMB24 Button Module	Charcoal Grey	700462518
SMB24 without faceplate	-	700462526
SMB24 Replacement Stand	Silver	700416571
Replacement Stand	Silver	700416563
Wedge Stand	Charcoal Grey	700383888
Wall Mounting Plate	Charcoal Grey	700383383
9600 Gigabit Ethernet Adapter	-	700383771
Bluetooth Adapter	-	700383789
Replacement Handset	Charcoal Grey	700416548
Amplified Speech Handset	Charcoal Grey	700446370
Replacement Handset Cord (9 feet)	Charcoal Grey	700383318
Replacement Handset Cord (25 feet)	Charcoal Grey	700383821
Replacement Line Cord	Charcoal Grey	700383326

---

## 12.9.51 9641G, 9641GS

- This phone is supported by the IP Office Release 8.0 Q1 2012 Service Pack and higher. The voice activated dialing and USB features are not supported.
- The previous restrictions against using the IP Office system as the HTTP file server for this type of phone have been removed.
- GLOBAL models do not include text labels under the buttons.

The phones support 24 programmable buttons which are displayed as touchscreen options. These can be used for call appearance functions and other IP Office features. In addition the phone supports a home screen on which the user can add up to 8 icons for programmable functions in addition to those icons present through installation configuration.

This phone can be used with up to 3 x BM12 or 3 x SBM24 button modules. Each module provides an additional 24 programmable buttons. Attaching button modules requires the phone to be powered as a Class 3 device by setting its power switch to the **H** position. If not being powered by PoE, these telephones use an Avaya Single Port PoE injector (SPPOE-xx).



Variant		SAP Code
9641G Telephone	Charcoal Grey	700480627
9641G Telephone Global	Charcoal Grey	700506517
9641G Telephone <a href="#">TAA</a> <sup>[388]</sup>	Charcoal Grey	700501431
9641G Telephone <a href="#">TAA</a> <sup>[388]</sup> Global	Charcoal Grey	700506519
9641GS Telephone Global	Charcoal Grey	700505992
9641GS Telephone <a href="#">TAA</a> <sup>[388]</sup> Global	Charcoal Grey	700509409
BM12 Button Module	Charcoal Grey	700480643
Dual Headset Adapter	Charcoal Grey	700503227
PoE Power Injector		SAP Code
Single Port PoE Injector (SPPOE-1A)	–	700500725
" US Power Cord	–	405362641
" European Power Cord	–	407786623
" UK Power Cord	–	407786599
" Australian Power Cord	–	407786631
" Indian Power Cord	–	407790591
" Argentina Power Cord	–	408161453
" Japanese Power Cord	–	700405681
Stands and Wall Mounts		SAP Code
9400/9500/9608/9611/9620 Wall Mount	–	700383375
9621/9630/9640/9641 Wall Mount	–	700383383
9608/9611 Replacement Stand	–	700500726
9621/9630/9640/9641 Stand	–	700416563
BM12 Replacement Stand	–	700500727
SBM24 Replacement Stand	–	700416571
9621/9630/9640/9641 Wedge Stand	–	700383888
Handset and Cables		
9600 Ethernet Cable	3 metres	700383326
9600 Handset	Charcoal Grey	700416548
9600 Amplified Handset	Charcoal Grey	700446370
9600 Handset Cord 9ft	Charcoal Grey	700383318
9600 Handset Cord 25ft	Charcoal Grey	700383821

## 12.9.52 9650, 9650C

These phones are supported on IP500 V2 systems running IP Office Release 6.0 and higher. The phones are supplied with a two-position stand.

- The availability of [VCM \(Voice Compression Module\)](#)<sup>[42]</sup> channels is necessary to support IP telephony. For IP Office 6.0+, these phones require an [Avaya IP Endpoints](#)<sup>[37]</sup> license.
- The voice activated dialing and USB features are not supported.
- For IP Office Release 6.1, these phones are supported running SIP software. When that is the case, the IP Office or IP Office Manager should not be used as the file server for the phone. Avaya SIP phones require an Avaya IP Endpoints license.
- The Class requirement of PoE powered phones may be increased if the phone is used with additional equipment such as a button module.

9650	Feature	9650	9650C
	<b>Connects via</b>	IP network.	IP network.
	<b>IP Office Release</b>	6.0+	6.0+
	<b>Programmable Buttons</b>	✓	✓
	<b>Headset Socket</b>	✓	✓
	<b>Handsfree Speaker/ Microphone</b>	✓/✓	✓/✓
	<b>Message Waiting Lamp</b>	✓	✓
	<b>PoE Class/Typical Idle Power Consumption</b>	Class 2	Class 2
	<b>Display</b>	1/3 VGA Greyscale	1/3 VGA Color
	<b>Supported Add-Ons</b>	<a href="#">SMB24</a> <sup>[33]</sup> x 3.	<a href="#">SMB24</a> <sup>[33]</sup> x 3.
	<b>Upgradeable Firmware</b>	✓	✓
<b>PC Pass-Through Port/ with Voice Priority</b>	✓/✓		

### Fixed Function Keys

✓  SPEAKER	✓  HEADSET	✓  MUTE	✓  VOLUME UP	✓  CONTACTS
✓  MESSAGE	✗  HOLD	✗  TRANSFER	✓  VOLUME DOWN	✓  CALL LOG
✗  DROP	✗  REDIAL	✗  CONFERENCE	✓  MENU	✗  FORWARD

Functions for fixed functions keys not present are accessible through display menu soft key functions.



Variant		SAP Code
<b>9650 Telephone</b>	Charcoal Grey	700383938
<b>9650C Telephone</b>	Charcoal Grey	700461213
<b>9650 without faceplate</b>	-	700408628
<b>9650C without faceplate</b>	-	700462526
<b>SMB24 Button Module</b>	Charcoal Grey	700462518
<b>SMB24 without faceplate</b>	-	700462526
<b>SMB24 Replacement Stand</b>	Silver	700416571
<b>Replacement Stand</b>	Silver	700416563
<b>Wedge Stand</b>	Charcoal Grey	700383888
<b>Wall Mounting Plate</b>	Charcoal Grey	700383383
<b>9600 Gigabit Ethernet Adapter</b>	-	700383771
<b>Bluetooth Adapter</b>	-	700383789
<b>Replacement Handset</b>	Charcoal Grey	700416548
<b>Amplified Speech Handset</b>	Charcoal Grey	700446370
<b>Replacement Handset Cord (9 feet)</b>	Charcoal Grey	700383318
<b>Replacement Handset Cord (25 feet)</b>	Charcoal Grey	700383821
<b>Replacement Line Cord</b>	Charcoal Grey	700383326

---

## 12.9.53 Audio Conferencing Unit

Avaya M and T-Series phones are supported by IP Office Release 7.0 and higher on an IP500 V2. They can be connected to digital station ports provided by an [IP500 TCM8 base card](#)<sup>[21]</sup>, [DS16A/DS30A external expansion module](#)<sup>[22]</sup> or [DS16B/DS30B external expansion module](#)<sup>[23]</sup>.

The Audio Conferencing Unit (ACU) is a multiple microphone desktop conferencing unit. The Audio Conferencing unit only supports the following Feature codes:

- **Speedial: Feature 0**

This feature code can be used to dial a stored number.

- If **Feature 0** is followed by a 3-digit number in the range 000 to 255, the system directory entry with the matching index is dialed.
- If **Feature 0** is followed by \* and a 2-digit number in the range 71 to 94, the personal directory entry with the matching index is dialed.

- **Hold/Switch Calls: Feature 2**

This feature code will hold the current call. If there was already a call on hold, the feature code will switch between calls.

- **Conference: Feature 3**

If the Audio Conferencing Unit has a call connected and another call on hold, using this feature code will conference the unit and those calls.

- **Last Number Redial: Feature 5**

When the phone is idle, this feature code can be used to redial the last number dialed from the Audio Conferencing Unit.

## 12.9.54 B100 Series

This is a series of high quality conference phones intended to support calls with multiple users speaking and listening via the same conference phone. They are supported by IP Office Release 7.0 and higher.

All the models support local call recording onto a SD card of up to 2GB capacity (not SDHC). Additional microphones can be added to each model.



- **B149 Conference Phone**  
Conference phone for personal office use and small and medium sized conference rooms. Connects to the IP500 V2 system using an analog extension port.
- **B159 Conference Phone**  
Conference phone for medium to large sized conference rooms. Connects to the IP500 V2 system using an analog extension port. This model can also be connected to a PC using USB or to a DECT/GSM device.
- **B169 Conference Phone**  
Conference phone for medium to large sized conference rooms. Connects to the IP500 V2 system using an analog extension port. This model can also be connected to a PC using USB or to a DECT/GSM device.
- **B179 Conference Phone**  
Conference phone for medium to large sized conference rooms. Connects as a SIP extension using an Avaya IP Endpoint license.

---

## 12.9.55 D100 Series

The D160 is a DECT mobile telephone handset. It connects to a DECT base station that supports up to 8 D100 series handsets. The base station itself connects to the IP Office using a SIP trunk configured on the IP Office. The base station and phone are supported by IP Office Release 8.1 Feature Pack 1 and higher.

A single base station can support up to eight handsets, with each handset supporting five calls. Each IP Office can support up to four base stations. Each D100 Series handset appears in the IP Office configuration as a SIP extension and requires an **Avaya IP Endpoint** license and available VCM resources.

The D100 SIP DECT Wireless telephone system is approved in the following regions:

- USA
- Canada
- European Union
- Switzerland
- South Africa
- Turkey
- Norway

	SAP Code
<b>D160 Firmware Upgrade Cable</b>	700503106
<b>Power Supply for D100 Repeater and D160 Charging Stand</b>	700503108
<b>D160 Charging Stand (without power supply)</b>	700503109
<b>D160 Battery</b>	700503110
<b>D160 Belt Clip (Package of 5)</b>	700503111

### 12.9.56 E129

The E129 is an Avaya SIP phone. It supports auto-answer, handsfree and headset operation and integration with IP Office voicemail. The phone uses PoE or a separate power supply unit. The phone includes a PC bypass port. Can be wall mounted if required.



---

## 12.9.57 ETR 6, ETR 6D

This phone is supported with IP Office Release 6.0 and higher. It is only supported on an ETR6 card in IP500 V2 systems. They are only supported in IP Office Basic Edition - PARTNER® Mode or IP Office Basic Edition modes running in a North American locale. They are not supported on systems which have their companding mode set to A-Law.

Both 'Refresh' and 'Euro Style' variants of the phones are supported. An additional analog device using the same extension number can be connected via the ETR phone's AUX socket.



## 12.9.58 ETR 18, ETR 18D

This phone is supported with IP Office Release 6.0 and higher. It is only supported on an ETR6 card in IP500 V2 systems. They are only supported in IP Office Basic Edition - PARTNER® Mode or IP Office Basic Edition modes running in a North American locale. They are not supported on systems which have their companding mode set to A-Law.

Both 'Refresh' and 'Euro Style' variants of the phones are supported. An additional analog device using the same extension number can be connected via the ETR phone's AUX socket.



---

## 12.9.59 ETR 34D

This phone is supported with IP Office Release 6.0 and higher. It is only supported on an ETR6 card in IP500 V2 systems. They are only supported in IP Office Basic Edition - PARTNER® Mode or IP Office Basic Edition modes running in a North American locale. They are not supported on systems which have their companding mode set to A-Law.

Both 'Refresh' and 'Euro Style' variants of the phones are supported. An additional analog device using the same extension number can be connected via the ETR phone's AUX socket.

A maximum of 4 ETR 34D phones are supported on a system with a maximum of 2 on any individual ETR6 base card.





### 12.9.60 M7100

Avaya M and T-Series phones are supported by IP Office Release 7.0 and higher on an IP500 V2. They can be connected to digital station ports provided by an [IP500 TCM8 base card](#)<sup>[21†]</sup>, [DS16A/DS30A external expansion module](#)<sup>[22†]</sup> or [DS16B/DS30B external expansion module](#)<sup>[23†]</sup>.



### 12.9.61 M7100N

Avaya M and T-Series phones are supported by IP Office Release 7.0 and higher on an IP500 V2. They can be connected to digital station ports provided by an [IP500 TCM8 base card](#)<sup>[21†]</sup>, [DS16A/DS30A external expansion module](#)<sup>[22†]</sup> or [DS16B/DS30B external expansion module](#)<sup>[23†]</sup>.



---

### 12.9.62 M7208

Avaya M and T-Series phones are supported by IP Office Release 7.0 and higher on an IP500 V2. They can be connected to digital station ports provided by an [IP500 TCM8 base card](#)<sup>[21†]</sup>, [DS16A/DS30A external expansion module](#)<sup>[22†]</sup> or [DS16B/DS30B external expansion module](#)<sup>[23†]</sup>.



### 12.9.63 M7208N

Avaya M and T-Series phones are supported by IP Office Release 7.0 and higher on an IP500 V2. They can be connected to digital station ports provided by an [IP500 TCM8 base card](#)<sup>[21†]</sup>, [DS16A/DS30A external expansion module](#)<sup>[22†]</sup> or [DS16B/DS30B external expansion module](#)<sup>[23†]</sup>.



### 12.9.64 M7310

Avaya M and T-Series phones are supported by IP Office Release 7.0 and higher on an IP500 V2. They can be connected to digital station ports provided by an [IP500 TCM8 base card](#)<sup>[21]</sup>, [DS16A/DS30A external expansion module](#)<sup>[22]</sup> or [DS16B/DS30B external expansion module](#)<sup>[23]</sup>.



### 12.9.65 M7310N

Avaya M and T-Series phones are supported by IP Office Release 7.0 and higher on an IP500 V2. They can be connected to digital station ports provided by an [IP500 TCM8 base card](#)<sup>[21]</sup>, [DS16A/DS30A external expansion module](#)<sup>[22]</sup> or [DS16B/DS30B external expansion module](#)<sup>[23]</sup>.



---

## 12.9.66 M7324

Avaya M and T-Series phones are supported by IP Office Release 7.0 and higher on an IP500 V2. They can be connected to digital station ports provided by an [IP500 TCM8 base card](#)<sup>[21†]</sup>, [DS16A/DS30A external expansion module](#)<sup>[22†]</sup> or [DS16B/DS30B external expansion module](#)<sup>[23†]</sup>.

- Additional buttons can be supported on a M7324 phone through the addition of [KLM button module](#)<sup>[33†]</sup>.



## 12.9.67 M7324N

Avaya M and T-Series phones are supported by IP Office Release 7.0 and higher on an IP500 V2. They can be connected to digital station ports provided by an [IP500 TCM8 base card](#)<sup>[21†]</sup>, [DS16A/DS30A external expansion module](#)<sup>[22†]</sup> or [DS16B/DS30B external expansion module](#)<sup>[23†]</sup>.



### 12.9.68 T7000

Avaya M and T-Series phones are supported by IP Office Release 7.0 and higher on an IP500 V2. They can be connected to digital station ports provided by an [IP500 TCM8 base card](#)<sup>[21†]</sup>, [DS16A/DS30A external expansion module](#)<sup>[22†]</sup> or [DS16B/DS30B external expansion module](#)<sup>[23†]</sup>.

The T7000 telephone is an entry-level digital set for basic low-use office environments. The T7000 is used primarily in the EMEA (not available in North America).



### 12.9.69 T7100

Avaya M and T-Series phones are supported by IP Office Release 7.0 and higher on an IP500 V2. They can be connected to digital station ports provided by an [IP500 TCM8 base card](#)<sup>[21†]</sup>, [DS16A/DS30A external expansion module](#)<sup>[22†]</sup> or [DS16B/DS30B external expansion module](#)<sup>[23†]</sup>.



---

## 12.9.70 T7208

Avaya M and T-Series phones are supported by IP Office Release 7.0 and higher on an IP500 V2. They can be connected to digital station ports provided by an [IP500 TCM8 base card](#)<sup>[21]</sup>, [DS16A/DS30A external expansion module](#)<sup>[22]</sup> or [DS16B/DS30B external expansion module](#)<sup>[23]</sup>.





### 12.9.71 T7316

Avaya M and T-Series phones are supported by IP Office Release 7.0 and higher on an IP500 V2. They can be connected to digital station ports provided by an [IP500 TCM8 base card](#)<sup>[217]</sup>, [DS16A/DS30A external expansion module](#)<sup>[227]</sup> or [DS16B/DS30B external expansion module](#)<sup>[230]</sup>.



---

## 12.9.72 T7316E

Avaya M and T-Series phones are supported by IP Office Release 7.0 and higher on an IP500 V2. They can be connected to digital station ports provided by an [IP500 TCM8 base card](#)<sup>[21]</sup>, [DS16A/DS30A external expansion module](#)<sup>[22]</sup> or [DS16B/DS30B external expansion module](#)<sup>[23]</sup>.

- Additional buttons can be supported on a T7316E phone through the addition of [T7316E KEM](#)<sup>[33]</sup> button modules.





### 12.9.73 T7406, T7406e

Avaya M and T-Series phones are supported by IP Office Release 7.0 and higher on an IP500 V2. They can be connected to digital station ports provided by an [IP500 TCM8 base card](#)<sup>[21]</sup>, [DS16A/DS30A external expansion module](#)<sup>[22]</sup> or [DS16B/DS30B external expansion module](#)<sup>[23]</sup>.

These cordless phones use a base station that can support multiple sets. The T7406E base station supports up to 4 T7406E handsets. The T7406 base station supports up to 3 T7406 handsets. Each supported handset requires a connection from the base station to a BST port on the IP Office system.

Each phone is dedicated to its base station and cannot roam even if multiple base stations are installed.

The T7406E is available in North America, Mexico and Caribbean countries excluding Jamaica and Trinidad. The T7406E replaces the discontinued T7406 cordless telephone.



## 12.9.74 T3 Classic

This phone is supported in Europe only (A-Law only). The T3 Classic has 2 Link ports for optional add-on T3 Headset and or T3 DSS units (up to 2 further T3 DSS units can be chained from the first T3 DSS).

The IP Office supports T3 UPN and IP phones. It does not support T3 IPN phones. Previous restrictions against using T3 phones on systems with other types of digital stations no longer apply.

T3 Classic	Feature	Detail
	<b>Connects via</b>	DS port.
	<b>IP Office Release</b>	3.1+. [Not Small Office Edition]
	<b>Programmable Buttons</b>	✓ 4.
	<b>Headset Socket*</b>	✓
	<b>Handsfree Speaker/Microphone</b>	✓/✓
	<b>Message Waiting Lamp</b>	✓
	<b>Upgradeable Firmware</b>	✗

\*Using optional T3 Headset Link unit.

Variant	Colour	SAP Code
T3 UPN Classic	Black	700380272
	White	700380306
T3 IP Classic	Black	700414733
	White	700414725
T3 DSS Unit	Black	700380322
	White	700380330
T3 DSS Expansion Unit	Black	700380348
	White	700380355
T3 IP Power Supply Unit		700414766
AEI/Headset Link for T3 IP		700414774
Power Supply for T3 IP DSS		700414790
Headset Link for T3 UPN		700380363

## 12.9.75 T3 Comfort

This phone is supported in Europe only (A-Law only). The T3 Classic has 2 Link ports for optional add-on T3 Headset and or T3 DSS units (up to 2 further T3 DSS units can be chained from the first T3 DSS).

The IP Office supports T3 UPN and IP phones. It does not support T3 IPN phones. Previous restrictions against using T3 phones on systems with other types of digital stations no longer apply.

T3 Comfort	Feature	T3 Comfort
	<b>Connects via</b>	DS ports.
	<b>IP Office Release</b>	3.1+ [Not Small Office Edition]
	<b>Programmable Buttons</b>	✓ 10.
	<b>Headset Socket*</b>	✓
	<b>Handsfree Speaker/Microphone</b>	✓/✓
	<b>Message Waiting Lamp</b>	✓
	<b>Upgradeable Firmware</b>	✗

\*Using optional T3 Headset Link unit.

Variant	Colour	SAP Code
T3 UPN Comfort	Black	700380280
	White	700380314
T3 IP Comfort	Black	700414758
	White	700414741
T3 DSS Unit	Black	700380322
	White	700380330
T3 DSS Expansion Unit	Black	700380348
	White	700380355
T3 IP Power Supply Unit		700414766
AEI/Headset Link for T3 IP		700414774
Power Supply for T3 IP DSS		700414790
Headset Link for T3 UPN		700380363

## 12.9.76 T3 Compact

This phone is supported in Europe only (A-Law only). The T3 Classic has 1 Link port for optional add-on T3 Headset or T3 DSS units (up to 2 further T3 DSS units can be chained from the first T3 DSS).

The IP Office supports T3 UPN and IP phones. It does not support T3 IPN phones. Previous restrictions against using T3 phones on systems with other types of digital stations no longer apply.

T3 Compact	Feature	T3 Compact
	<b>Connects via</b>	DS ports.
	<b>IP Office Release</b>	3.1+ [Not Small Office Edition]
	<b>Programmable Buttons</b>	✓ 10.
	<b>Headset Socket</b>	✓
	<b>Handsfree Speaker/Microphone</b>	✓/✓
	<b>Message Waiting Lamp</b>	✓
	<b>Upgradeable Firmware</b>	✗

\*Using optional T3 Headset Link unit.

Variant	Colour	SAP Code
T3 UPN Compact	Black	700380264
	White	700380298
T3 IP Compact	Black	700414717
	White	700414709
T3 DSS Unit	Black	700380322
	White	700380330
T3 DSS Expansion Unit	Black	700380348
	White	700380355
T3 IP Power Supply Unit		700414766
AEI/Headset Link for T3 IP		700414774
Power Supply for T3 IP DSS		700414790
Headset Link for T3 UPN		700380363

## 12.10 Phone Add-Ons

For IP Office Release 5.0 and higher, the maximum combined number of buttons on buttons modules per system is 1024. T3 DSS modules are not included in the combined limits stated above but are limited to 30 T3 DSS modules (1080 buttons).

- **1100 KEM:** +18 (*Max 3 per phone, 56 per system.*)  
Add-on for 1120E and 1140E phones. Each module provides 18 additional programmable buttons.
- **1200 KEM:** +12 (*Max 7 per phone, 85 per system.*)  
Add-on for 1220 and 1230 phones. Each module provides 12 additional programmable buttons.
- **4450**<sup>[327]</sup>: +60 (*Max 2 per phone, 2 per external expansion module or control unit, 8 per system.*)  
Add-on for 4412D+ and 4424D+ phones. Provides an additional 60 programmable buttons with a single lamp - red except for the bottom two rows which are green. Due to the single lamp not recommended for appearance functions as not all button states can be indicated.
- **BM12:** +24 (*Max 3 per phone, 32 per system.*)  
Add-on for [9508](#)<sup>[288]</sup>, [9608](#)<sup>[290]</sup>, [9611](#)<sup>[292]</sup> and [9641](#)<sup>[302]</sup> phones. Provides 12 buttons assignable in 2 pages for 24 features. When used with a 9508, power must be supplied to the phone using an inline power module such as the 1151C or equivalent.
- **BM32**<sup>[328]</sup>: +32 (*Max 3 per phone, 32 per system.*)  
Add-on for the 1616 phones that provides two columns of 16 buttons. Up to 3 BM32 modules are supported with any 1616. However, when used with more than one module the telephone must be powered from a power supply unit rather than PoE.
- **DBM32**<sup>[329]</sup>: +32 (*Max 3 per phone, 32 per system.*)  
Add-on for the 1416 phones that provides two columns of 16 buttons. Up to 3 BM32 modules are supported with any 1416. When used with a DBM32 button module, the telephone must be powered from a power supply unit.
- **EU24**<sup>[330]</sup>: +24 (*Max 1 per phone, 8 per system.*)  
Add-on for the 2420, 4620, 4620SW, 4625, 5420, 5620, 5620SW and 5621. Provides an additional 24 programmable buttons. Button display icons are on two switchable pages with 12 icons on each page.
- **EU24BL**<sup>[331]</sup>: +24 (*Max 1 per phone, 8 per system.*)  
As per the EU24 above but with a backlight function to match the 4621. Not supported on the 2420 and 5420.
- **KLM**<sup>[332]</sup>: +48 (*Max 2 per phone, 21 per system.*)  
Used with [M7324](#)<sup>[316]</sup> phones. Up to 2 buttons modules are supported per phone. Each button module provides 48 programmable buttons.
- **SMB24**<sup>[333]</sup>: +24 (*Max 3 per phone, 42 per system.*)  
Supported with 9630G, 9640, 9640G, 9650 and 9650C telephones. For IP Office Release 9.0, also supported with 9608, 9611G and 9641G.
- **T3 DSS**<sup>[334]</sup>: +36 (*Max 3 per phone, 30 per system.*)  
Up to 3 of these units can be connected to any of the IP Office T3 phones. Each provides an additional 36 programmable buttons. Each button includes a single red status LED. Maximum 3 per phone, 30 per system. Connection of the T3 DSS varies:
  - With non-IP models, the first T3 DSS connects directly to a link port on the phone. No additional power supplies are required.
  - With T3 IP Models, the first T3 DSS connects to a DSS Link Unit fitted to the phone. A power supply is required for the DSS.
- **T7316E KEM**<sup>[335]</sup>: +24 (*Max 9 per phone, 42 per system.*)  
Used with [T7316E](#)<sup>[320]</sup> phones. Each button module provides 24 programmable buttons. Up to 4 buttons modules are supported per phone without additional power supply. Up to 4 buttons modules are supported per phone without additional power supply. From 5 to 9 modules can be supported with additional power. Maximum 9 per phone (4 without additional power).
- **XM24**<sup>[336]</sup>: +24 (*Max 1 per phone, 2 per expansion module or control unit, 21 per system.*)  
Add-on for 6416D and 6424D phones. Provides an additional 24 programmable buttons. Connects direct to phone.

---

## 12.10.1 201B RIM

The 201B Recorder Interface Module (RIM) is supported for use with 2420 and 5420 phones. It provides the phone with a 3.5mm mini-RCA jack socket for connection of recording devices. It also provides two headset sockets which can be used in place of the phones existing headset socket (the phone and the RIM sockets can not be used at the same time).

- The 201B is the RoHS compliant replacement for the 201A. The 20B stand is the RoHS complaint replacement for the 20A stand.

To install the 201B, the phones existing stand must be removed and be replace by a 20B stand (also called the 20B Module Adapter Base). This is an expanded stand that includes two slots, into one of which the 201B can be inserted. However only one 201B is supported per phone.

Use of the 20B and therefore the 201B requires the phone to be powered by a 1151D1 or 1151D2 power supply unit. Full installation instructions are included with the 20B Stand.

Item		SAP Code
201B Recorder Interface Module		700381635
20B Stand		700381650
EU24	Multi-Grey	700381817
1151D1 Power Supply	With CAT5 cable.	700434897
1151D2 Power Supply with battery backup.	With CAT5 cable.	700434905
1151D1/1151D2 Power Cord	USA	405362641
	Europe	407786623
	Australia/New Zealand	407786631
	India	407790991
	United Kingdom	407786599
	Argentina	408161453

## 12.10.2 4450



The maximum number of button module buttons supported, of any type, on a single system is [1024](#)<sup>[325]</sup>.

The DSS4450 works in association with the 4412D and 4424D telephones, each of which can support up to two DSS4450 adjuncts.

Each DSS4450 provides an additional 60 programmable keys with single red lamps except for the bottom two rows which have green lamps. The DSS4450 requires an auxiliary Avaya power supply unit and must be used with the cables supplied.

IP Office supports a maximum 2 x 4450 units on each Digital Station expansion module, including the IP406 V2 control unit. A maximum of 8 x 4450 units total are supported on the whole IP Office system. For additional limitations see [Phone Add-Ons](#)<sup>[325]</sup>.

This phone is not supported on the IP500 DS8 Extension Card. For the IP500 it will work on external Digital Station Expansion Modules.

4450	Feature	Detail
	Connects via	DSS port on phone.
	Supported by	4412D+, 4424D+
	Maximum per phone	2.
	Maximum per DS module/ control unit	2.
	Maximum per IP Office system	8.
	Additional requirements	4450 power supply unit on phone.
	IP Office Release	1.0+
	Programmable Buttons	✓ 60 (50x  / 10x  ).

Item	SAP Code
4450 (Black)	108199696
4450 (White)	108199407
Small 4400 Series Stand (Black)	108541194
Small 4400 Series Stand (White)	108541202
Power Supply for 4450	108596412

---

### 12.10.3 BM32

The maximum number of button module buttons supported, of any type, on a single system is [1024](#)<sup>[325]</sup>.

The BM32 add on provides an additional 32 twin-LED programmable buttons for 1616 phones. The units do not require their own power supply connection as they draw power from the phone to which they are connected.

- Up to 3 units can be connected in a chain from a single 1616.
- To support more than one BM32, the phone must be powered by an individual 1600 Series Power Adapter.
- Up to a maximum of 32 BM32 units on the system. For additional limitations see [Phone Add-Ons](#)<sup>[325]</sup>.

Item	SAP Code
BM32 BUTTON MODULE	700415573
<b>Accessories</b>	
1600 SERIES BM32 CABLE - REPLACEMENT	700415581
1600 SERIES BM32 BOND BRIDGE - REPLACEMENT	700415599
1616/BM32 PLASTIC LABEL COVERS (20) - REPLACEMENT	700415672
1600 SERIES BM32 FLIP STAND - REPLACEMENT	700432800
<b>Paper Labels</b>	
1616/BM32 PAPER DESI LABELS - PACKAGE OF 50 LABELS (8.5" x 11")	700415656
1616/BM32 PAPER DESI LABELS - PACKAGE OF 50 LABELS (A4)	700434236



## 12.10.4 DBM32

The maximum number of button module buttons supported, of any type, on a single system is [1024](#)<sup>[325]</sup>.

The DBM32 add on provides an additional 32 twin-LED programmable buttons for 1416 phones. The units do not require their own power supply connection as they draw power from the phone to which they are connected.

- When used with a DBM32 button module, the telephone must be powered from a 1151D1/D2 power supply unit.
- Up to 3 units can be connected in a chain from a single 1416.
- Up to a maximum of 32 DBM32 units on the system.

Item	SAP Code
DBM32 BUTTON MODULE	700469968
1151D1 Power Supply	700434897
<b>Accessories</b>	
1600 SERIES BM32 CABLE - REPLACEMENT	700415581
1600 SERIES BM32 BOND BRIDGE - REPLACEMENT	700415599
1616/BM32 PLASTIC LABEL COVERS (20) – REPLACEMENT	700415672
1600 SERIES BM32 FLIP STAND - REPLACEMENT	700432800
<b>Paper Labels</b>	
1616/BM32 PAPER DESI LABELS - PACKAGE OF 50 LABELS (8.5" x 11")	700415656
1616/BM32 PAPER DESI LABELS - PACKAGE OF 50 LABELS (A4)	700434236

-  **Note for Australian installations only:**

Installations of the 1416 terminal with an 1151 PSU and DBM32 must be restricted to the same building as the host Gateway. That is, the 1416 – if installed with an 1151 PSU and DBM32 – cannot be connected in a campus environment where the 1416 terminal is installed in a building separate from the building housing the Gateway. This application cannot be used with exposed (out-of-building) wiring.

- For installations in which the 1416 is used without the 1151 PSU and DBM32, campus connections are acceptable: the 1416 can be located in a separate building in these cases.
- This restriction applies to Australian installations only.

## 12.10.5 EU24

The maximum number of button module buttons supported, of any type, on a single system is [1024](#)<sup>[325]</sup>.

Provides an additional 24 programmable buttons. For additional limitations see [Phone Add-Ons](#)<sup>[325]</sup>.

- ⚠ Only the cable supplied with the EU24/EU24BL should for connection to the EU24/EU24BL. This cable should only be connected to the port marked EU24 on suitable phones. Doing otherwise will cause damage to the EU24/EU24BL and the equipment to which it is attached.

EU24	Feature	Detail
	Connects via	EU24 port on phone.
	Supported by	2420, 4620, 4621, 4625, 5420, 5620, 5621.
	Maximum per phone	1.
	Maximum per IP Office	8.
	Additional Requirements	A 1151 Type power supply unit must be used to power the phone.
	IP Office Release	3.0+
	Programmable Buttons	✔ 24.

Item		SAP Code
EU24 1XU-A Expansion Module	Multi-Grey	700381817
1151D1 Power Supply	With CAT5 cable.	700434897
1151D2 Power Supply with battery backup.	With CAT5 cable.	700434905
1151D1/1151D2 Power Cord	USA	405362641
	Europe	407786623
	Australia/New Zealand	407786631
	India	407790991
	United Kingdom	407786599
	Argentina	408161453

## 12.10.6 EU24BL

The maximum number of button module buttons supported, of any type, on a single system is [1024](#)<sup>[325]</sup>.

Provides an additional 24 programmable buttons. The EU24BL is physically similar to the EU24 but includes a backlight function that matches 4621 phone. For additional limitations see [Phone Add-Ons](#)<sup>[325]</sup>.

- ⚠ Only the cable supplied with the EU24/EU24BL should for connection to the EU24/EU24BL. This cable should only be connected to the port marked EU24 on suitable phones. Doing otherwise will cause damage to the EU24/EU24BL and the equipment to which it is attached.

EU24BL	Feature	Detail
	Connects via	EU24 port on phone.
	Supported by	4620, 4621, 4625, 5620, 5621.
	Maximum per phone	1.
	Maximum per IP Office	8.
	Additional requirements	A 1151 Type power supply unit must be used to power the phone.
	IP Office release	3.1+.
	Programmable Buttons	✓ 24.

Item		SAP Code
EU24BL 2XU-A Backlighted Expansion Module	Multi-Grey	700381544
1151D1 Power Supply	With CAT5 cable.	700434897
1151D2 Power Supply with battery backup.	With CAT5 cable.	700434905
1151D1/1151D2 Power Cord	USA	405362641
	Europe	407786623
	Australia/New Zealand	407786631
	India	407790991
	United Kingdom	407786599
	Argentina	408161453

---

## 12.10.7 KLM Module

The maximum number of button module buttons supported, of any type, on a single system is [1024](#)<sup>[325]</sup>.

This type of button module can be used with the [M7324](#)<sup>[316]</sup> phones to provide additional programmable buttons. For IP Office standard modes, up to 2 modules can be attached to each phone. For IP Office Basic Edition modes only 1 module can be attached to each phone. Each module requires its own power supply unit.

<b>+01</b>	<b>+13</b>	<b>+25</b>	<b>+37</b>
<b>+02</b>	<b>+14</b>	<b>+26</b>	<b>+38</b>
<b>+03</b>	<b>+15</b>	<b>+27</b>	<b>+39</b>
<b>+04</b>	<b>+16</b>	<b>+28</b>	<b>+40</b>
<b>+05</b>	<b>+17</b>	<b>+29</b>	<b>+41</b>
<b>+06</b>	<b>+18</b>	<b>+30</b>	<b>+42</b>
<b>+07</b>	<b>+19</b>	<b>+31</b>	<b>+43</b>
<b>+08</b>	<b>+20</b>	<b>+32</b>	<b>+44</b>
<b>+09</b>	<b>+21</b>	<b>+33</b>	<b>+45</b>
<b>+10</b>	<b>+22</b>	<b>+34</b>	<b>+46</b>
<b>+11</b>	<b>+23</b>	<b>+35</b>	<b>+47</b>
<b>+12</b>	<b>+24</b>	<b>+36</b>	<b>+48</b>

## 12.10.8 SMB24

The maximum number of button module buttons supported, of any type, on a single system is [1024](#)<sup>[325]</sup>.

This button module is supported with 9630G, 9640, 9640G, 9650 and 9650C telephones. For IP Office Release 9.0, also supported with 9608, 9611G and 9641G. Up to 3 SMB24 modules can be attached to any one phone. For additional limitations see [Phone Add-Ons](#)<sup>[325]</sup>.

- The Class requirement of PoE powered phones may be increased if the phone is used with additional equipment such as a button module.



Variant		SAP Code
<b>SMB24 Button Module</b>	Charcoal Grey	700462518
<b>SMB24 without faceplate</b>	-	700462526
<b>SMB24 Replacement Stand</b>	Silver	700416571

## 12.10.9 T3 DSS

The maximum number of button module buttons supported, of any type, on a single system is [1024](#)<sup>[325]</sup>.

The T3 DSS provides an additional 36 programmable keys for phones in the supported T3 series. The T3 DSS is moulded and designed to be attached to the associated phone. Signalling is achieved by cable connection to the Link port on the T3 phone. A further two T3 DSS units can be chained from the first T3 DSS. For additional limitations see [Phone Add-Ons](#)<sup>[325]</sup>.

Feature	Detail
Connects via	Link port on phone.
Supported by	T3 Compact, T3 Classic, T3 Comfort
Maximum per phone	3.
Maximum per DS module	-.
Additional requirements	None.
IP Office release	3.1+.
Programmable Buttons	✔ 36.

Item	Colour	SAP Code
T3 DSS Unit	Black	700380322
	White	700380330
T3 DSS Expansion Unit	Black	700380348
	White	700380355

### 12.10.10 T7316e KEM

The maximum number of button module buttons supported, of any type, on a single system is [1024](#)<sup>[325]</sup>.

This type of button module can be used with the [T7316E](#)<sup>[326]</sup> phones to provide 24 additional programmable buttons. For IP Office standard modes, up to 9 modules can be added per phone, though addition power requirements apply if more than 4 modules are used with a phone. For IP Office Basic Edition mode, only 4 modules can be added per phone.



+01	+13
+02	+14
+03	+15
+04	+16
+05	+17
+06	+18
+07	+19
+08	+20
+09	+21
+10	+22
+11	+23
+12	+24

## 12.10.11 XM24

The maximum number of button module buttons supported, of any type, on a single system is [1024](#)<sup>[325]</sup>.

Connects to the XM24 port on the base of 6416 and 6424 phones. Requires the phone to have a separate power supply using an Avaya 1151D1 or 1151D2 power supply unit and a power outlet socket are required. For additional limitations see [Phone Add-Ons](#)<sup>[325]</sup>.

XM24	Feature	XM24
	Connects via	XM24 port on phone.
	Supported by	6416+, 6424+
	Maximum per phone	1.
	Maximum per DS module/control unit	2.
	Maximum per IP Office system	10
	Additional requirements	1151D1 or 1151D2 PSU for phone.
	IP Office Release	1.0+.
	Programmable Buttons	✓ 24.

Item		SAP Code
XM24	Grey	700406523
	White	700406515
XM24 Stand	Grey	108272378
	White	108272386
1151D1 Power Supply.	With CAT5 cable.	700434897
1151D2 Power Supply with battery backup.	With CAT5 cable.	700434905
1151D1/1151D2 Power Cord	USA	405362641
	Europe	407786623
	Australia and New Zealand	407786631
	India	407790991
	United Kingdom	407786599
	Argentina	408161453



## 12.11 Ancillary Systems

### 12.11.1 Digital Mobility Solution

Avaya 4100 Series and 7400 Series phones are supported using a Digital Mobility Solution (DMS). This is a DECT system that can be used to support up to 64 handsets. The DMS connects to the IP500 system using a BST port for each handset.

<b>Digital Mobility 2.4 GHz solution - North America and CALA</b>		
7420 Handset		N7B80BK
7430 Handset		N7B80BLE6
7440 Handset		N7B80BQE6
Digital Mobility Base Station 10	2.4GHz, Compatible with Handset 7430/7440, Repeater 40.	N7B65KPE5
Digital Mobility Repeater 40	2.4GHz, Compatible with Handset 7430/7440, Base station 10.	N7B80AGE5
Digital Mobility External Antenna 51	International.	N7B65KWE5
DMC 080 Digital Mobility Controller	North America.	N7B65KJE5
DMC 320 Digital Mobility Controller	North America.	N7B65KKE5
<b>Digital Mobility 1.9 GHz solution - North America</b>		
7439 Handset	Replaces the 7430 model.	N7B80CLE6
7449 Handset	Replaces the 7430 model.	N7B80CNE6
Digital Mobility Base Station 19	North America.	N7B80CRE6
Digital Mobility Repeater 49	Canada, US.	N7B80CUE6
Digital Mobility External Antenna 51	International.	N7B65KWE5
DMC 080 Digital Mobility Controller	North America.	N7B65KJE5
DMC 320 Digital Mobility Controller	North America.	N7B65KKE5
<b>Digital Mobility 1.8 GHz solution - Europe, Hong Kong, Australia, New Zealand</b>		
4135 Handset	Europe & Hong Kong	N7B80BME6
4145 Handset	Europe & Hong Kong	N7B80BRE6
4145EX Handset KIT - EU	Ruggedized version of 4145 - Europe & Hong Kong	N7B80BWE6
4136 Handset	Australia/New Zealand	N7B80CCE6
4146 Handset	Australia/New Zealand	N7B80CEE6
4146EX Handset	Ruggedized version of 4146 - Australia/New Zealand	N7B80CFE6
Digital Mobility Base Station 15		N7B65KTE5
Digital Mobility Repeater 25		N7B65KUE5
Digital Mobility Repeater 45		N7B80AHE5
Digital Mobility External Antenna 51	International	N7B65KWE5
DMC 081 Digital Mobility Controller	International	N7B80AAE5
DMC 321 Digital Mobility Controller	International	N7B80ABE5
<b>Digital Mobility 1.8 GHz solution - South America</b>		
7434 (South America)		N7B80ACE6
7444 (South America)		N7B80ADE6
Digital Mobility Base Station 14		N7B80AEE6
Digital Mobility Repeater 24		N7B80AFE6
Digital Mobility External Antenna 51	International	N7B65KWE5
DMC 081 Digital Mobility Controller	International	N7B80AAE5
DMC 321 Digital Mobility Controller	International	N7B80ABE5

---

## 12.11.2 DECT R4

Avaya 3720, 3725, 3740 and 3749 phones connect to the DECT base stations in a DECT R4 system. They then connect to the IP Office via the IP network.

Avaya 3701 and 3711 phones are also supported but only as GAP compatible devices.

## 12.12 Applications

This section outlines the requirements for various IP Office applications. These are just outlines, for full details refer to the specific installation manuals for those applications and to the IP Office Technical Bulletins.

- [IP Office Application Server](#) <sup>[346]</sup>
- [ContactStore for IP Office](#) <sup>[346]</sup>
- [one-X Portal for IP Office](#) <sup>[341]</sup>
- [Avaya Communicator](#) <sup>[343]</sup>
- [SoftConsole](#) <sup>[344]</sup>
- [IP Office Video SoftPhone](#) <sup>[344]</sup>
- [TAPI](#) <sup>[347]</sup>
- [Voicemail Pro](#) <sup>[348]</sup>
- [Web Collaboration](#) <sup>[348]</sup>
- [IP Office Manager](#) <sup>[341]</sup>
- [System Monitor](#) <sup>[341]</sup>
- [System Status Application \(SSA\)](#) <sup>[346]</sup>

## 12.12.1 IP Office Application Server

The IP Office Application Server is a single server installation package for the IP Office applications listed below. The DVD installs a CentOS Linux operating system, the IP Office applications and a set of web pages for server management. Note that the installation overwrites any existing operating system and data on the server PC.

- [one-X Portal for IP Office](#)<sup>[34†]</sup>  
User and configuration access is via web browser in the same way as for a Windows server installation of one-X Portal for IP Office.
- [Voicemail Pro](#)<sup>[34†]</sup>  
Configuration access is done using a Windows installation of the Voicemail Pro client software. An installation package for the Voicemail Pro client is included on the IP Office Application Server server.

For Voicemail Pro server running on a Linux based platform, the following features are not supported:

- **VB Scripting**
- **3rd Party Database Integration**
- **VPNM**
- **UMS Web Voicemail**  
(However, access via IMAP and one-X Portal for IP Office are available as alternatives.)

When logged into the voicemail server using the Voicemail Pro client, those features not supported are grayed out or hidden. If those features are present in an imported call flow, they will not function and calls attempting to use those features will be disconnected.

The Voicemail Pro client's backup and restore functions cannot currently be used to move voicemail data between a Linux based server and a Windows based server or vice versa. The client functions for importing and exporting module and the call flow database can be used.

For Small Community Network scenarios where multiple voicemail servers are present, for example distributed and backup server, a mix of Linux based and Windows based servers are allowed.

Details	
<b>DVD</b>	IP Office Application Server Release 9.1 DVD Set (2)
<b>License</b>	✓ - Depends on the IP Office applications selected during installation. The IP Office Application Server server itself does not require any license.

### PC Requirements

For PC requirements refer to the appropriate IP Office installation or implementation manual for the application. For operating system and browser support refer to [Operating System Summary](#)<sup>[35†]</sup>.

## 12.12.2 ContactStore

[Voicemail Pro](#)<sup>[34†]</sup> can be used for manual and automatic call recording. Normally those recordings are placed into the mailbox specified for the user or hunt group whose call is being recorded and are then treated as normal messages. Contact Store allows those recordings to be redirected into a database on the ContactStore PC. This allows recordings to be archived and searched separately from user messages. User access to Contact Store is via web browser. This application requires entry of a license into the IP Office configuration.

- For IP Office Release 6.0 and higher, the supported Windows version of ContactStore for IP Office is 7.8.
- For Linux based voicemail servers, Windows ContactStore is only supported for IP Office Release 8.1 Feature Pack 1 and higher.
- For IP Office Release 9.0 and higher, the Linux based Contact Recorder for IP Office application performs the same functionality.

Details	
<b>DVD</b>	IP Office Release 9.1 User/Admin DVD Set (2) (700506051) (Disk 2)
<b>License</b>	✓ VMPRO Recordings Administrators. See <a href="#">Voicemail Pro Licenses</a> <sup>[37†]</sup> .

### PC Requirements

For PC requirements refer to the appropriate IP Office installation or implementation manual for the application. For operating system and browser support refer to [Operating System Summary](#)<sup>[35†]</sup>.

### 12.12.3 IP Office Manager

This tool is used to access all parts of the IP Office configuration. Different levels of access can be defined to control which parts of the configuration the IP Office Manager user can view and alter. IP Office Manager is also used to upgrade the software files used by an IP Office system. When running is also acts as a TFTP server from which some Avaya phones can request new software.

- **IP Office Manager Version**

It is important to download and install the correct version of the IP Office administration suite including IP Office Manager.

- For system installation, you should use the version of IP Office Manager that matches the IP Office release required on the system. The sets the version of IP Office software loaded when [recreating the System SD card](#)<sup>[75]</sup>.
- For system maintenance, the version of IP Office Manager used sets the version of IP Office software uploaded to a system when [upgrading the system](#)<sup>[164]</sup>.
- For system configuration IP Office Manager is backward compatible. IP Office Manager Version 9.1 is backwards compatible for configuring systems running software from IP Office Release 6.0 upwards. IP Office Manager cannot load the configuration of an IP Office system running a higher version of software.

Details	
<b>DVD</b>	IP Office Release 9.1 User/Admin DVD Set (2) (700506051) (Disk 1)
<b>Languages</b>	English, Brazilian, Chinese (Simplified), Dutch, French, German, Italian, Russian, Spanish (Mexican).
<b>License</b>	✗ No license required.

#### PC Requirements

For PC requirements refer to the appropriate IP Office installation or implementation manual for the application. For operating system and browser support refer to [Operating System Summary](#)<sup>[356]</sup>.

### 12.12.4 Monitor

Monitor (also known as System Monitor) is a tool that can show all activity on the IP Office system in great detail. As a consequence, interpretation of Monitor traces requires a high-level of data and telephony protocol knowledge. However, all IP Office installers and maintainers must understand how to run Monitor when necessary as Avaya may request copies of Monitor traces to resolve support issues.

For IP Office 4.0 and higher, the [System Status Application](#)<sup>[346]</sup> has been added to provide more easily interpreted information than is provided by Monitor.

Details	
<b>DVD</b>	IP Office Release 9.1 User/Admin DVD Set (2) (700506051) (Disk 1)
<b>Languages</b>	English only.
<b>License</b>	✗ No license required.

#### PC Requirements

For PC requirements refer to the appropriate IP Office installation or implementation manual for the application. For operating system and browser support refer to [Operating System Summary](#)<sup>[356]</sup>.

### 12.12.5 one-X Portal for IP Office

This application is installed on a server PC connected to the IP Office. Users can access the one-X portal from their own PC using a web browser. The application allows the user to control their phones, access voicemail messages, call logs and phone directories.

Details	
<b>DVD</b>	IP Office Release 9.1 User/Admin DVD Set (2) (700506051) (Disk 2) or IP Office Application Server Release 9.1 DVD Set (2)
<b>License</b>	✓ See <a href="#">User Licenses</a> <sup>[373]</sup> .
<b>Languages</b>	Brazilian Portuguese, Czech, Dutch, English (UK), English (US), French, German, Italian, Japanese, Korean, Polish, Russian, Swedish, Turkish and Latin Spanish.

The details below are for a Windows based server installation of one-X Portal for IP Office. one-X Portal for IP Office can also be installed as part of a Linux based server installation using the [IP Office Application Server DVD](#)<sup>[346]</sup>. Additional plugins supported for use with one-X Portal for IP Office have their own operating system requirements, refer to the one-X Portal for IP Office documentation for details.

---

## PC Requirements

For PC requirements refer to the appropriate IP Office installation or implementation manual for the application. For operating system and browser support refer to [Operating System Summary](#)<sup>[350]</sup>.

## 12.12.6 Avaya Communicator

Avaya Communicator is a user softphone application which allows the user to make and answer their calls from a range of telephone devices. Avaya Communicator client software is available Windows, iPad and Android devices.

Details	
<b>License</b>	✔ See the table below.
<b>Languages</b>	Dutch, English (UK), English (US), French, Italian, Brazilian Portuguese, Russian and Spanish.

Avaya Communicator is supported on IP Office standard mode systems. The features available to the user depend on how the user is licensed for Avaya Communicator and whether the system also includes [one-X Portal for IP Office](#)<sup>[347]</sup> and [Voicemail Pro](#)<sup>[348]</sup>.

		Avaya Communicator Mode	
		Lite Mode	Advanced Mode
<b>Basic Features</b>		<ul style="list-style-type: none"> <li>• Make calls, hold calls, mute and transfer calls.</li> <li>• System directory.</li> <li>• Local application call log.</li> </ul>	<ul style="list-style-type: none"> <li>• Make calls, hold calls, mute and transfer calls.</li> <li>• System directory.</li> <li>• Local application call log.</li> </ul>
<b>Advanced Features</b> <i>(Require one-X Portal for IP Office and Voicemail Pro)</i>		–	<ul style="list-style-type: none"> <li>• User directories and call logs via one-X Portal for IP Office</li> <li>• Presence (XMPP).</li> <li>• 2-Party Instant Messaging</li> <li>• 2-Party video calls.</li> <li>• Dual extension support.</li> </ul>
<b>User Profile</b>		Any user profile.	<ul style="list-style-type: none"> <li>• <b>Office Worker</b> or</li> <li>• <b>Power User</b>.</li> </ul>
<b>Licenses Required</b>	<b>System License</b>	–	<ul style="list-style-type: none"> <li>• <b>Essential Edition*</b></li> <li>• <b>Preferred Edition</b></li> </ul>
	<b>User Licenses</b>	<ul style="list-style-type: none"> <li>• <b>Avaya Softphone</b> license.</li> </ul>	<ul style="list-style-type: none"> <li>• <b>Office Worker</b> or</li> <li>• <b>Power User</b>.</li> </ul>
<b>System Mode</b>	<b>IP Office Essential Edition</b>	✔ Yes	–
	<b>IP Office Preferred Edition</b>	✔ Yes	✔ Yes
<b>Client Connection</b>		Support for basic mode features is provided directly by the IP Office system.	Support for advanced mode features is provided by the one-X Portal for IP Office and Voicemail Pro applications.

- **Client Software**

The source for the Avaya Communicator client software depends on the user device. However, since Avaya Communicator is supported on a number of Avaya platforms, in all cases the installer must ensure that they obtains a Avaya Communicator client that specifically states IP Office support.

### Windows PC Requirements

For PC requirements refer to the appropriate IP Office installation or implementation manual for the application. For operating system and browser support refer to [Operating System Summary](#)<sup>[350]</sup>.

## 12.12.7 SoftConsole

This is a licensed application. It is intended for telephone system operators or receptionists. It displays details of calls directed to the user and allows them to quickly see the status of the callers required destination and transfer the call. The SoftConsole user is able to access a range of details about the status of users and groups on the IP Office system.

- The IP Office SoftConsole works in conjunction with a physical IP Office extension phone to provide the speech path for calls.
- Up to 4 simultaneous SoftConsole users can be licensed.

Details	
<b>DVD</b>	IP Office Release 9.1 User/Admin DVD Set (2) (700506051) (Disk 1) or Linux server App Center tab.
<b>Languages</b>	Brazilian, Chinese (Simplified), Danish, Dutch, English (UK), English (US), Finnish, French, German, Italian, Korean, Japanese, Latin Spanish, Norwegian, Portuguese, Russian, Spanish and Swedish.
<b>License</b>	✔ Licensed application. See below.

## Licenses

License	Description	RFA Name	SAP
<b>Receptionist</b>	Adds one additional SoftConsole user. A maximum of four SoftConsole user can be licensed.	IPO LIC RECEPTIONIST RFA	171987

## PC Requirements

For PC requirements refer to the appropriate IP Office installation or implementation manual for the application. For operating system and browser support refer to [Operating System Summary](#) <sup>[356]</sup>.

## 12.12.8 IP Office Video SoftPhone

The IP Office Video SoftPhone application is the preferred SIP softphone application for use with IP Office systems. It includes IP Office specific features not available in other non-Avaya SIP softphone applications.

## Support

This IP Office Video SoftPhone Version 3.2 (Windows and Mac) is a legacy version only supported for existing users whose IP Office system has been upgraded to IP Office Release 9.1. For Mac users, this version is not supported on Mac OS X 10.9 (Mavericks).

New MAC users and MAC users wanting to run IP Office Video SoftPhone on Mac OS 10.9 should contact their system administrator regarding installing IP Office Video SoftPhone Version 4.0. New Windows users should be installed with Avaya Communicator.

Details	
<b>DVD</b>	Mac version 4.0 only: IP Office Release 9.1 User/Admin DVD Set (2) (700506051) (Disk 1) or Linux server App Center tab.
<b>License</b>	✔ Use of IP Office Video SoftPhone requires the IP Office system to contain the following licenses: <ul style="list-style-type: none"><li>• <b>System Licenses</b> Non-Server Edition systems must have <b>Essential Edition</b> and <b>Preferred Edition</b> licenses.</li><li>• <b>User Licenses</b> Users can only be enabled for softphone usage by first setting their profile to <b>Power User</b> or <b>Teleworker</b>. These are user modes licensed by the following licenses:<ul style="list-style-type: none"><li>• <b>Power User</b> license.</li><li>• <b>Teleworker</b> license.</li><li>• <b>Upgrade Mobile Worker to Power User</b> and Mobile Worker licenses.</li><li>• <b>Upgrade Office Worker to Power User</b> and Office Worker licenses.</li></ul></li><li>• <b>Application Licenses</b> For IP Office Release 9.1, the softphone applications also uses the following additional licenses:</li></ul>



- **Legacy Softphone**  
Version 3.2 legacy softphones are only supported with a **Legacy Softphone** license. For systems upgraded to IP Office Release 9.1, a **Legacy Softphone** license is automatically created for every existing **Power User, Teleworker, Upgrade Mobile Worker to Power User** and **Upgrade Office Worker to Power User** license.
- **IP Mac Softphone**  
Version 4.0 softphones uses a separate **Mac IP Softphone** license. It can also use **Legacy Softphone** licenses if no further **Mac IP Softphone** licenses are available.

## User PC Requirements

The following are the minimum and recommended requirements for IP Office Video SoftPhone.

Feature	Windows PC	Mac PC
<b>Operating System</b>	<ul style="list-style-type: none"> <li>• <b>Microsoft Windows 7 (32-bit and 64-bit).</b> Windows 7 support is only on Professional, Enterprise and Ultimate versions.</li> </ul>	<ul style="list-style-type: none"> <li>• <b>Version 3.2: Mac OS 10.6 to 10.7 only.</b></li> <li>• <b>Version 4.0: Mac OS 10.8, 10.9 and 10.10.</b></li> </ul>
<b>Processor</b>	<ul style="list-style-type: none"> <li>• <b>Minimum:</b> Pentium 4 2.4 GHz or equivalent. Video Card with DirectX 9.0c support.</li> <li>• <b>Optimal:</b> Intel Core 2 Duo or equivalent. Video Card with DirectX 9.0c support. For HD video, the minimum requirements are Intel Core 2 Duo 2.3 GHz or equivalent, hardware video acceleration, camera, 2GB RAM and DirectX 9.0c support.</li> </ul>	<ul style="list-style-type: none"> <li>• Intel Core i5.</li> </ul>
<b>Memory</b>	<ul style="list-style-type: none"> <li>• <b>Minimum:</b> 1GB RAM.</li> <li>• <b>Optimal:</b> 2GB RAM.</li> </ul>	
<b>Hard Disk Space</b>	<ul style="list-style-type: none"> <li>• 50MB.</li> </ul>	
<b>Sound Card</b>	<ul style="list-style-type: none"> <li>• Full-duplex, 16-bit or use USB headset.</li> </ul>	
<b>Additional</b>	<ul style="list-style-type: none"> <li>• <b>Windows Installation</b> For installation on Windows PCs, access to the following Windows updates, appropriate to the user's version of Windows operating system, is required if not already installed. <ul style="list-style-type: none"> <li>• Microsoft .NET Framework 4.</li> <li>• Microsoft Visual C++ 2008 SP1.</li> <li>• Microsoft KB967634 Hotfix.</li> </ul> </li> </ul>	–

---

## 12.12.9 System Status Application

This tool provides a wide range of information about the current status of an IP Office 4.0 or higher system. Its includes available resources and components within the system. This includes details of current call in progress. Details of the number of alarms are recorded and the time date of the most recent alarms.

When required for diagnostics escalation SSA is able to take a snap shot image of the IP Office system's status including a copy of its current configuration. Use of SSA requires an IP Office service user name and password that has been configured for System Status access in the IP Office's security settings.

- For IP500 V2 systems, SSA is pre-installed on the system's Avaya SD memory card and can be run by browsing to the IP Office system's IP address.

Details	
DVD	IP Office Release 9.1 User/Admin DVD Set (2) (700506051) (Disk 1)
License	✘ No license required.

### PC Requirements

For PC requirements refer to the appropriate IP Office installation or implementation manual for the application. For operating system and browser support refer to [Operating System Summary](#)<sup>[350]</sup>.

## 12.12.10 TAPI

IP Office TAPI is a client PC application that allows TAPI compliant applications to interact with the IP Office. The IP Office TAPI software can be used in one of two modes, depended on whether it is licensed or not. The same software is installed in either case with the licenses, if any, being entered in the IP Office system configuration.

- **1st Party TAPI**

In this unlicensed mode the TAPI software supports control of an individual user's associated extension, allowing a TAPI compliant application to answer (requires a phone that supports handsfree answer) and make calls.

- **3rd Party TAPI**

In this licensed mode, TAPI software can be used to control call function on multiple user extension. This mode is used with CTI Developer applications.

Details	
<b>DVD</b>	IP Office Release 9.1 User/Admin DVD Set (2) (700506051) (Disk 1)
<b>License</b>	✘ Optional. Licenses are required for 3rd party TAPI mode operation. See <a href="#">CTI Licenses</a> <sup>[379]</sup> .

### PC Requirements

For PC requirements refer to the appropriate IP Office installation or implementation manual for the application. For operating system and browser support refer to [Operating System Summary](#)<sup>[350]</sup>.

---

## 12.12.11 Voicemail Pro

This application requires various licenses entered into the IP Office configuration to control the features it offers and the number of simultaneous connections (IP500 = 40 (IP Office 5.0+) or 30 (pre-IP Office 5.0), IP500 V2 = 40). The operation of Voicemail Pro can be customized to provide special services. .

The Voicemail Pro software can be installed as separate Voicemail Pro client and server parts. This allows the remote administration of the Voicemail Pro server from a PC with just the Voicemail Pro client installed. A copy of the client is automatically installed locally with the Voicemail Pro server.

Source	
<b>DVD</b>	IP Office Release 9.1 User/Admin DVD Set (2) (700506051) (Disk 1) or IP Office Application Server Release 9.1 DVD Set (2)
<b>Languages</b>	Chinese (Mandarin and Cantonese), Danish, German, Greek, English (UK), English (US), Spanish, Latin Spanish, Finnish, French, French Canadian, Hungarian, Italian, Korean, Dutch, Norwegian, Polish, Portuguese, Brazilian, Swedish.
<b>License</b>	✔ See <a href="#">Voicemail Pro Licenses</a> <sup>[376]</sup> .

The details below are for a Windows based server installation of Voicemail Pro. Voicemail Pro can also be installed as part of a Linux based server installation using the [IP Office Application Server DVD](#) <sup>[346]</sup>.

The Voicemail Pro server part of the software consists of several components in addition to the core server software, these are:

- **Campaigns**

The Voicemail Pro can be configured to run a campaign. This consists of a series of questions for which the Voicemail Pro records the callers answer or key presses. The resulting recordings can then be played back by users. The web aspect of campaigns allows user to perform this playback and processing of campaign recordings via their web browser. This requires an IIS web server to be run on the same PC as the Voicemail Pro software.

- **Text to Speech (TTS)**

Through adding additional licenses, the Voicemail Pro is able to use the TTS functions of Windows to speak text and numbers to callers in addition to recording prompts. This is intended mainly for scenarios where the Voicemail Pro is obtaining text and number values from a customer database.

- **Unified Messaging Service (UMS)**

Voicemail Pro supports a feature called voicemail email to send messages or message alerts to a user's email mailbox. This however is a one-way process with no link back to the user's voicemail mailbox on whether the email has been read or deleted. UMS allows this to become a two-way process, where users can play voicemail messages through their email mailbox or voicemail mailbox.

### PC Requirements

For PC requirements refer to the appropriate IP Office installation or implementation manual for the application. For operating system and browser support refer to [Operating System Summary](#) <sup>[350]</sup>.

## 12.12.12 Web Collaboration

Web Collaboration is a service supported from IP Office Linux based one-X Portal for IP Office servers (except Unified Communications Module). It works in conjunction with one-X Portal for IP Office and Voicemail Pro.

Web Collaboration provides the user with functions to share documents, applications and their desktop in a web collaboration conference. This runs in parallel with an audio conference hosted by the IP Office system.

- Capacity matches the IP Office audio conferencing capacity.
- Host users must be licensed for one-X Portal for IP Office as an **Office Worker**, **Teleworker** or **Power User** profile plus also a **Web Collaboration** license.
- Hosts can upload documents in PDF, JPEG and PNG formats.
  - 10 documents per user
  - 6MB per document.
- Application and desktop sharing is not supported for MAC PC users.
- Launch from [browser URL](#) <sup>[352]</sup> or directly from Avaya Communicator, one-X Portal and portal Outlook plugin and Call Assistant.
- Languages: English, French, Spanish, German, Italian, Portuguese, Russian, Swedish, Chinese, Japanese, Korean

## 12.12.13 IP Office Ports

Details of the range of ports used by IP Office and IP Office applications are found at <https://support.avaya.com/helpcenter/getGenericDetails?detailId=C201082074362003>.

Most PC firewalls requests the user to allow various exceptions when a newly installed application first runs. However this is not always the case, especially if the firewall is located elsewhere than the user's PC.

## 12.13 Operating System Summary

This sections summarizes the support for IP Office applications by IP Office Release 9.1.

Some specific features of applications may have additional requirements. Those requirements will be details in the specific installation manual for the application. Unless otherwise stated, the operating system is the latest supported version from the operating system developer.

### 12.13.1 Windows Support

The table below list the IP Office applications installable on supported Windows operating system. It does not include [browseable applications](#)<sup>(352)</sup>.

IP Office Application	Windows 7		Windows 8.1		2008/ 2008 R2		2012/ 2012 R2
	32	64	32	64	32	64	64
<b>Server Applications</b>							
ContactStore	-	-	-	-	✓	-	-
one-X Portal for IP Office	-	-	-	-	✓	✓	✓
IP Office Contact Center	-	-	-	-	-	✓	✓
Voicemail Pro Server	✓	✓	✓	✓	✓	✓	✓
... plus UMS	-	-	-	-	✓	✓	✓
... plus campaigns	-	-	-	-	✓	✓	✓
... MAPI service for Linux Voicemail Pro	✓	✓	-	-	✓	✓	✓
<b>User Applications</b>							
one-X Portal plug-in for Outlook	✓	✓	✓	✓	-	-	-
" plug-in for Salesforce	✓	✓	✓	✓	-	-	-
" Call Assistant	✓	✓	✓	✓	-	-	-
" plug-in for MS Lync 2010	✓	✓	✓	✓	-	-	-
" plug-in for MS Lync 2013	✓	✓	✓	✓	-	-	-
Avaya Communicator	✓	✓	✓	✓	-	-	-
SoftConsole	✓	✓	✓	✓	-	-	-
TAPI - 1st Party	✓	✓	✓	✓	✓	✓	✓
TAPI - 3rd Party	✓	✓	✓	✓	✓	✓	✓
Web Conferencing Desktop Sharing	✓	✓	✓	✓	-	-	-
IP Office Video SoftPhone	✓	✓	-	-	-	-	-
<b>Maintainer Applications</b>							
IP Office Manager	✓	✓	✓	✓	✓	✓	✓
System Monitor	✓	✓	✓	✓	✓	✓	✓
System Status Application	✓	✓	✓	✓	✓	✓	✓
Voicemail Pro Client	✓	✓	✓	✓	✓	✓	✓

- Where supported, Windows 7 support is only on Professional, Enterprise and Ultimate versions.

## 12.13.1.1 Outlook Support

Application\Outlook Version	2003	2007	2010	2012
Voicemail Pro IMS	✓	-	-	-
Voicemail Pro UMS/IMAP	✓	✓	✓	✓
TAPI Dialing	✓	✓	✓	✓
one-X Portal for IP Office plug-in for Outlook	-	✓	✓	✓

## 12.13.1.2 Single Windows Server Support

The following scenarios are supported for combining IP Office server applications onto a single server PC. In all cases, the individual requirements of each application as if installed on a separate server still apply. However, depending on the combination of applications, additional restrictions also apply as detailed below.

	Voicemail Pro	one-X Portal for IP Office	Minimum IP Office Release	Minimum PC Specification
1.	16 Ports	-	Release 5.0	As per each application.
2.	8 Ports (4 TTS)	50 Simultaneous users.	Release 6.0	2GHz Dual Core, 4GB RAM, Windows 2008 R2 Server (32 or 64-bit).
3.	16 ports (8 TTS)	150 Simultaneous users.	Release 6.0	2GHz Quad Core, 6GB RAM, Windows 2008 R2 64-bit.

- Voicemail Pro includes UMS, VB Scripting and 3rd party database operation. ContactStore is not supported on a virtual server.
- The supported virtual servers are:
  - **VMWare Server.**
  - **Microsoft Virtual Server 2005 R2.**
  - **Microsoft Server Hyper-V.**
- When used in a virtual server configuration, one-X Portal for IP Office requires a 2GB RAM virtual machine. Voicemail Pro requires a 1GB RAM virtual machine.

## 12.13.2 Mac OS Support

The table below list the IP Office applications installable on supported Mac operating system. It does not include [browseable applications](#)<sup>[352]</sup>.

IP Office Application	10.5	10.6	10.7	10.8	10.9	10.10
	Leopard	Snow Leopard	Lion	Mountain Lion	Mavericks	Yosemite
Web Collaboration Desktop Sharing	-	-	✓	✓	-	-
IP Office Video SoftPhone Version 3.2	-	✓	✓	-	-	-
IP Office Video SoftPhone Version 4.0	-	-	-	✓	✓	✓

## 12.13.3 Linux Support

A number of IP Office server applications (Voicemail Pro, one-X Portal for IP Office, Web Conferencing and Contact Recorder for IP Office) can run on a Linux operating system. However, they are only supported when run on the [IP Office Application Server](#)<sup>[346]</sup> which includes the installation of its own operating system. No IP Office applications are supported on other 3rd-party Linux operating systems.

## 12.13.4 Browser Support

The table below lists the support for IP Office applications which are accessed using a web browser.

Application\Browser	Internet Explorer			Firefox	Google Chrome	Safari 7
	8.0	10.0	11.0			
Voicemail Pro Campaigns	✓	✓	✓	-	-	-
Voicemail Pro UMS	✓	✓	✓	-	-	-
ContactStore	✓	✓	✓	-	-	-
one-X Portal for IP Office <sup>[1]</sup>	✓	✓	✓	✓	✓	✓
" Salesforce plug-in.	✓ <sup>[2]</sup>	✓ <sup>[2]</sup>	-	✓ <sup>[3]</sup>	-	-
IP DECT R4 Admin	✓	✓	✓	✓	✓	✓
D100 DECT Admin	✓	✓	✓	✓	✓	✓
IP Office Web Manager <sup>[4]</sup>						
" on PC	-	✓	✓	✓	✓	-
" on iPad tablet (iOS6)	-	-	-	-	✓	✓
" on Android tablet (KitKat 4.4)	-	-	-	-	✓	-

### Notes:

- one-X Portal for IP Office browsing is not supported from Windows server operating systems.
- The version of IE must match the operating system. For example 32-bit browser on a 32-bit OS.
- Firefox Version 16.
- Some IP Office Web Manager features are only supported on Windows PC operating systems: Backup, restore, upgrade, launch System Status Application/Voicemail Pro/IP Office Manager, file management.



## 12.14 Physical Ports

The following port types are found on the IP Office control unit and external expansion modules:

- **ANALOG** <sup>[358]</sup>  
Used for the connection of external analog trunks.
- **AUDIO** <sup>[358]</sup>  
Used for input of an external music on hold source.
- **BRI** <sup>[358]</sup>  
Used for connection of BRI trunks (Quad BRI trunk card). In IP Office standard modes they can also be used for ISDN terminals devices (So8 module).
- **BST (RJ21)** <sup>[359]</sup> and **BST (RJ45)** <sup>[359]</sup>  
Connections for M-Series and T-Series phones supported by IP Office. Also for Digital Mobility Solution system supporting 4100 Series and 7400 Series phones. See supported [Avaya BST digital phones](#) <sup>[39]</sup>.
- **DC I/P** <sup>[360]</sup>  
Power input from external power supply unit.
- **DS** <sup>[360]</sup>  
Connection of Avaya digital station phones supported by IP Office.
- **RS232/DTE** <sup>[367]</sup>  
Used for control unit maintenance under Avaya guidance. On expansion modules not used.
- **EF** <sup>[361]</sup>  
Emergency power failure ports found on the ETR6 base card.
- **ETR** <sup>[361]</sup>  
Only supported on IP500 V2 control unit running in IP Office Basic Edition - PARTNER® Mode or IP Office Basic Editions.
- **EXPANSION** <sup>[362]</sup>  
Used for interconnection of external expansions modules and control units.
- **EXT O/P** <sup>[178]</sup>  
Used to control external relay systems. The port provides two switchable (on, off and pulse) controls.
-   
Used for connection of functional or protective ground if required.
- **LAN** <sup>[363]</sup>  
10/100Mbps Ethernet LAN ports.
- **PF** <sup>[364]</sup>  
Analog power fails ports.
- **PHONE** <sup>[365]</sup> (**POT**) <sup>[365]</sup>  
Analog phone extension ports. On older units these ports are labeled as POT ports.
- **PRI** <sup>[366]</sup>  
PRI trunk ports.

## 12.14.1 Cables

The IP Office systems are designed primarily for use within an RJ45 structured cabling system using CAT3 unshielded twisted-pair (UTP) cabling and RJ45 sockets.

A structured cabling system is one where cables are run from a central RJ45 patch panel in the communications/data room to individual RJ45 sockets at user locations. All wires in each cable between the patch panel and the desk socket are connected straight through. This arrangement allows devices connected at the patch panel to be swapped to match the type of device that needs to be connected at the user socket. For example, making one user socket a phone port and another user socket a computer LAN port, without requiring any rewiring of the cables between the patch panel and the user location.

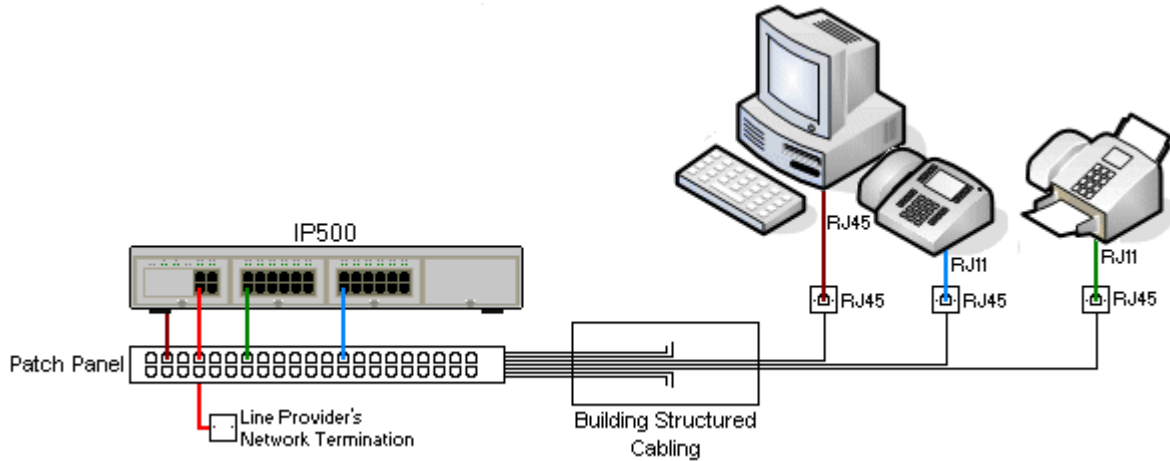

- **Traditional IDC Punchdown Wiring Installations**

Where necessary, the far end RJ45 plug can be stripped from IP Office cables and wired into traditional wiring systems using punch-block connectors. This type of installation should be performed by an experienced wiring technician.

- **Trunk Connections**

The majority of IP Office trunk ports use RJ45 connectors for acceptance of an RJ45-to-RJ45 cable. However, connection at the line provider's end may require use of a different plug type in order to match the line providers equipment.

- **RJ11 Phone Connectors**

Many phones use RJ11 sockets and are supplied with RJ11-to-RJ11 cables. RJ11 plugs can be inserted into RJ45 sockets and in many case the connection will work. However this is not recommended or supported as the connection lock is not truly positive and may become disconnected. An [RJ45-to-RJ11 cable](#)<sup>[36]</sup> is available for these connections.

## Standard IP Office Cables

The following are Avaya standard cables available for use with IP Office systems. The maximum length is applicable if the standard Avaya cable is replaced with an alternate cable.

Cable	Description	SAP Code	Standard Length	Maximum Length
<a href="#">9-Way DTE Cable</a> <sup>[367]</sup>	Connects to control unit RS232 DTE port. 9-Way D-type plug to 9-way D-type socket.	-	2m/6'6".	2m/6'6".
<a href="#">Structured Cabling DS Line Cable</a> <sup>[366]</sup>	Connects from RJ45 sockets to RJ11 socketed DS and analog phones.	TT700047871	4m/13'2".	See table below.
<a href="#">BRI/PRI Trunk Cable</a> <sup>[358]</sup>	Connects BRI/PRI trunk ports to the line provider's network termination point. RJ45 to RJ45. Red.	700213440	3m/9'10".	-
<a href="#">Expansion Interconnect Cable</a> <sup>[362]</sup>	Connects the control unit to expansion modules. RJ45 to RJ45. Blue. May be replaced by a yellow interconnect cable (2m (6'6") - 700472871) supplied with the <a href="#">IP500 4-Port Expansion</a> <sup>[20]</sup> card when using that card.	700213457	1m/3'3".	1m/3'3".
<a href="#">LAN Cable</a> <sup>[363]</sup>	Connects from IP Office LAN ports to IP devices. RJ45 to RJ45. Grey.	700213481	3m/9'10".	100m/328'.

The table below details the maximum total cable distances for DS and analog extensions using different cable thicknesses. Cabling should be Category-1 unshielded twisted pair cable or better.

Telephone	Unshielded Twisted-Pair (UTP) - 50nf/Km		
	AWG22 (0.65mm)	AWG24 (0.5mm)	AWG26 (0.4mm)
<b>1400 Series</b>	1200m/3937'.	1000m/3280'.	670m/2200'.
<b>2400/5400 Series</b>	1200m/3937'.	1000m/3280'.	670m/2200'.
<b>4406D Phone</b>	1000m/3280'.	1000m/3280'.	400m/1310'.
<b>4412D Phone</b>	1000m/3280'.	700m/2295'.	400m/1310'.
<b>4424D</b>	500m/1640'.	500m/1640'.	400m/1310'.
<b>9500 Series</b>	1200m/3937'.	1000m/3280'.	670m/2200'.
<b>T3 Series</b>	1000m/3280'.	1000m/3280'.	400m/1310'.
<b>BST</b>	580m/1900'.	365m/1200'.	228m/750'.
<b>Analog Phones</b>	1000m/3280'.	1000m/ 3280'.	400m/1640'.
<b>ETR Phones</b>	305m/1000'.	305m/1000'.	122m/400'.

## 12.14.2 ANALOG Port

These ports are analog trunk ports. IP500 analog trunk cards only support loop-start trunks. The [ATM16 Analog Trunk](#) module supports both loop-start and ground-start trunks, switchable within the IP Office configuration.

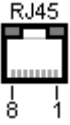
ANALOG	Pin	Description
	1	Not used.
	2	Not used.
	3	Not used.
	4	Ring.
	5	Tip.
	6	Not used.
	7	Not used.
	8	Not used.

- **Off-Hook Current:** 25mA.

- **⚠ IMPORTANT**

In all IP Office installations, any module being used for analog trunk connections must be connected to a [functional earth](#).

- **⚠ WARNING**

Within the Republic of South Africa and in areas of high lightning risk, any module using analog trunk connections must be connected to a [protective ground](#) and to [surge protection equipment](#).

## 12.14.3 AUDIO Port

This port is found on the rear of all IP Office control units. It is used for the input of an external music-on-hold sound source. Note that if the IP Office has loaded an internal music-on-hold sound file, any input from this socket is ignored.

The port is a 3.5mm stereo jack socket suitable for use with the most standard audio leads and connection to the 'headphone' output socket of most audio systems.

The use of a 'headphone' socket allows simple volume adjustment. Connection via a 'Line Out' socket may require additional equipment in order to adjust the volume level.

Pin No.	Description
Common	● Common
Left	◀ Audio In - Left Channel.
Right	◀ Audio In - Right - Channel.

- Input impedance: 10k /channel. Maximum a.c. signal – 200mV rms.

## 12.14.4 BRI Port (So)

The BRI ports found on the front of the So8 module are BRI So interface ports for connect to ISDN terminal devices. For IP Office 4.2+, IP500 BRI trunk daughter cards can be switched from To to So mode.

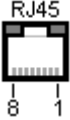
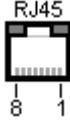
IP Office			Wire	ISDN Terminal	
RJ45	Pin	BRI		PIN	RJ45
	1	-	White/Orange	1	
	2	-	Orange/White	2	
	3	← Rx-A	White/Green	3	
	4	→ Tx-B	Blue/White	4	
	5	→ Tx-A	White/Blue	5	
	6	← Rx-B	Green/White	6	
	7	-	White/Brown	7	
	8	-	Brown/White	8	

### • Terminating Resistors

100ohm Terminating resistors are required across the transmit and receive wire pairs at each end of the S-bus.

- The IP Office So8 module BRI ports include integral 100ohm terminating resistors.
- For IP Office 4.2+, individual ports of an IP500 BRI daughter card can be switched to So mode. This is done by setting the **Line Sub-Type** to **S-Bus** in the IP Office configuration. In this case terminating resistors must be added at the IP Office end in addition to those at the other end of the S-bus connection.
  - Addition of the necessary termination at the IP Office end can be done using an IP500 BRI So Converter Cable (700458649). This short (25cm/10") cable includes both the necessary terminating resistors and the cable cross-over.
- Many ISDN terminal devices includes terminating resistors. If this is not the case, 100ohm (+/-5%) resistors must be connected across the receive wire pair and the transmit wire pair in the junction box immediately before the last ISDN terminal on the S-bus.

## 12.14.5 BRI Port (To)

These ports are BRI To interface ports for connection to external BRI trunk services. Note that BRI ports found on the IP500 So8 module are BRI-S interface ports for connect to ISDN terminal devices, see [BRI Port \(So\)](#) <sup>[35]</sup>.

### PRI/BRI Trunk Cable

This cable is used to connect from IP Office BRI/PRI trunk ports to the line providers network termination equipment. If that equipment does not use RJ45 sockets, the cable may need to be stripped and rewired or an alternate cable used. The appropriate signal pin-outs and wire colours are detailed below.

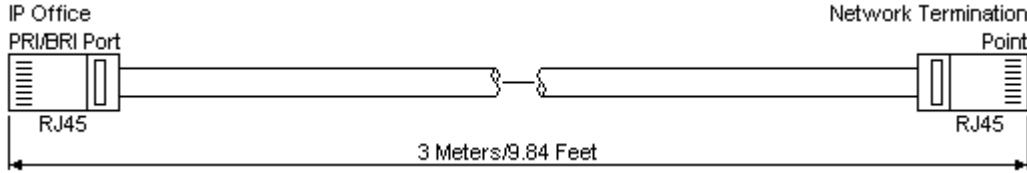

IP Office				Wire	Network Termination	
BRI	RJ45	BRI	PRI		PIN	RJ45
	1	-	← Rx-A	White/Orange	1	
	2	-	← Rx-B	Orange/White	2	
	3	→ Tx-A	-	White/Green	3	
	4	← Rx-A	→ Tx-A	Blue/White	4	
	5	← Rx-B	→ Tx-B	White/Blue	5	
	6	→ Tx-B	-	Green/White	6	
	7	-	-	White/Brown	7	
	8	-	-	Brown/White	8	

- Supply: BRI/PRI trunks cards are not supplied with these cables.
- Cable Color: Red.
- SAP Code: 700213440.
- Standard Length: 3m/9'10".
- Maximum Length: 5m/16'5".
- Though not used pins 7 and 8 are through connected for ease of construction.

### 12.14.6 BST Port (RJ21)

These ports are found on [IP500 Digital Station 16A/30A](#)<sup>[227]</sup> external expansion modules. They are supported by IP500 V2 systems running IP Office Release 7.0 and higher. See supported [Avaya BST digital telephones](#)<sup>[39]</sup>.

#### 1st RJ21 Connector

Port		Pin	Wire
1	Tip	26	White/Blue
	Ring	1	Blue/White
2	Tip	27	White/Orange
	Ring	2	Orange/White
3	Tip	28	White/Green
	Ring	3	Green/White
4	Tip	29	White/Brown
	Ring	4	Brown/White
5	Tip	30	White/Slate
	Ring	5	Slate/White
6	Tip	31	Red/Blue
	Ring	6	Blue/Red
7	Tip	32	Red/Orange
	Ring	7	Orange/Red
8	Tip	33	Red/Green
	Ring	8	Green/Red
9	Tip	34	Red/Brown
	Ring	9	Brown/Red
10	Tip	35	Red/Slate
	Ring	10	Slate/Red
11	Tip	36	Black/Blue
	Ring	11	Blue/Black
12	Tip	37	Black/Orange
	Ring	12	Orange/Black
13	Tip	38	Black/Green
	Ring	13	Green/Black
14	Tip	39	Black/Brown
	Ring	14	Brown/Black
15	Tip	40	Black/Slate
	Ring	15	Slate/Black
16	Tip	41	Yellow/Blue
	Ring	16	Blue/Yellow
Not Used		42	Yellow/Orange
		17	Orange/Yellow
		43	Violet/Slate
		08	Slate/Violet

#### 2nd RJ21 Connector

Port		Pin	Wire
1	Tip	26	White/Blue
	Ring	1	Blue/White
2	Tip	27	White/Orange
	Ring	2	Orange/White
3	Tip	28	White/Green
	Ring	3	Green/White
4	Tip	29	White/Brown
	Ring	4	Brown/White
5	Tip	30	White/Slate
	Ring	5	Slate/White
6	Tip	31	Red/Blue
	Ring	6	Blue/Red
7	Tip	32	Red/Orange
	Ring	7	Orange/Red
8	Tip	33	Red/Green
	Ring	8	Green/Red
9	Tip	34	Red/Brown
	Ring	9	Brown/Red
10	Tip	35	Red/Slate
	Ring	10	Slate/Red
11	Tip	36	Black/Blue
	Ring	11	Blue/Black
12	Tip	37	Black/Orange
	Ring	12	Orange/Black
13	Tip	38	Black/Green
	Ring	13	Green/Black
14	Tip	39	Black/Brown
	Ring	14	Brown/Black
Not Used		40	Black/Slate
		15	Slate/Black
		41	Yellow/Blue
		16	Blue/Yellow
		42	Yellow/Orange
		17	Orange/Yellow
		43	Violet/Slate
		08	Slate/Violet

### 12.14.7 BST Port (RJ45)

These ports are found on the [IP500 Digital Station 16B/30B expansion modules](#)<sup>[236]</sup>. They are supported by IP500 V2 systems running IP Office Release 9.0 and higher. See supported [Avaya BST digital phones](#)<sup>[39]</sup>.

## 12.14.8 DC I/P Port

Found on all IP Office control units and expansion modules. Used for connection from the external [power supply unit](#)<sup>[30]</sup> supplied with the control unit or module.

- No other type of power supply unit should be used with the module or module unless specifically indicated by Avaya.
- Power cords must not be attached to the building surface or run through walls, ceilings, floors and similar openings.

## 12.14.9 DS Ports (RJ45)

These ports are used for connection from an RJ45 structured cabling system to digital station phones supported by the IP Office. DS ports are provided by [IP500 Digital Station Cards](#)<sup>[208]</sup>, [IP500 ATM Combination Cards](#)<sup>[203]</sup>, [IP500 BRI Combination Cards](#)<sup>[208]</sup> and [IP500 Digital Station](#)<sup>[228]</sup> external expansion modules.

Though the RJ11 to RJ11 cables supplied with some phones can be plugged directly into RJ45 ports including those on IP Office modules, this is not recommended as the connection lock is not positive and may become disconnected.



DS ports on Digital Station expansion modules can be connected to [out-of-building extensions](#)<sup>[36]</sup>. If this is the case, connection must be made via suitable protective devices at each end and via each building primary protection. In addition, the Digital Station module must be connected to a protective ground.

### Structured Cabling Line Cord

This is an RJ45 to RJ11 cable suitable for connection from a structured cabling system RJ45 port to a DS phone. It can also be used for two-wire analog phone extensions.

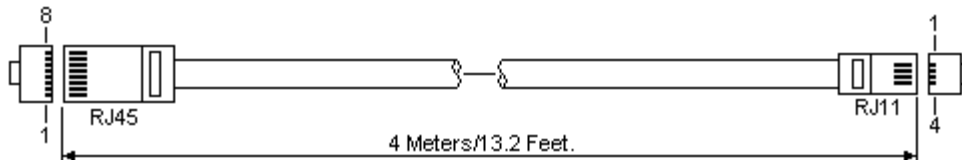
This cable is not suitable for connection from an Avaya 1151D1/B2 power supply unit to a DS phone with a 4450, EU24 or XM24 add-on module. In those cases the cables supplied with the power supply unit and the add-on module should be used.

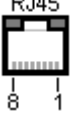

IP Office			Phone	
DS Port	Pin	Description	Pin	Port
	1	Not used.	-	
	2	Not used.	1	
	3	Not used.	2	
	4	Signal 1.	3	
	5	Signal 2.	4	
	6	Not used.	5	
	7	Not used.	6	
	8	Not used.	-	

- SAP Code: T700047871.



### **12.14.10 EF Port**

These ports are found on the ETR6 base card. They are analog trunk ports that are only useable when the card is fitted with an IP500 analog trunk daughter card. When in power fail, the EF ports are connected to trunk port 12.

### **12.14.11 ETR Port**

ETR (Enhanced Tip and Ring) ports are provided by the ETR6 base card. They can be used for the connection of DTMF analog phone devices and Avaya ETR phones.

- Paging to external paging equipment is not supported via ETR6 ports. It is supported via POT ports.

## 12.14.12 EXPANSION Port

This type of port is found on the rear of IP Office control units and external expansion modules. It is used for connecting the external expansion modules to their parent IP Office control unit.

The connection between these ports should only be done using an Avaya Expansion Interconnect Cable. No other cable type should be used.

- Each external expansion module is supplied with a blue 1 meter (3'3") expansion interconnect cable. This cable must be used when connecting to expansion ports on the rear of a control unit.
- When connecting to expansion ports on an IP500 4-Port Expansion card, a yellow 2 meter (6'6") expansion interconnect cable can be used in place of the standard blue cable. 4 Yellow cables are supplied with the IP500 4-Port Expansion card.

### Expansion Interconnect Cable

The Expansion Interconnect cable is used to link expansion ports between the IP Office control unit and external expansion modules.

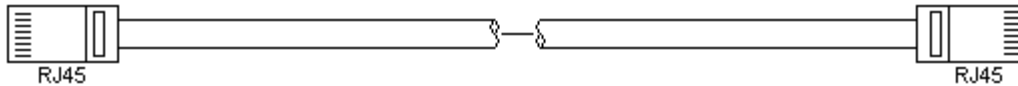

- Supply: One cable is normally supplied with each external expansion module.
- SAP Code: 1m (3'3") Blue cable - 700213457, 2m (6'6") Yellow cable - 700472871.

## 12.14.13 EXT O/P Port

These ports are found on the rear of all IP Office control units. They are used for connection to external switching relays. The port uses a standard 3.5mm stereo jack plug for connection.

The IP Office is able to open (high resistance), close (low resistance) or pulse (close for 5 seconds and then open) two switches within the port. Either switch can be operated separately. These switches are intended for activation of external relays in systems such as door opening systems.

### CAUTION:

In installations where this port is connected to a device external to the building, connection must be via a ITW Linx MDS2 Surge Protector and a protective ground connection must be provided on the IP Office control unit. When using the MDS2 on the Ext O/P port, use only the Line 1 and Equipment 1 jacks, do not use the Line 2 or Equipment 2 jacks.

EXT O/P	Pin	Description
	1	Switch 1.
	2	Switch 2.
	3	0 Volts (Ground/Chassis)

- Switching Capacity: 0.7A.
- Maximum Voltage: 55V d.c.
- On state resistance: 0.7 ohms.
- Short circuit current: 1A.
- Reverse circuit current capacity: 1.4A.
- Ensure that pins 1 and 2 are always at a positive voltage with respect to pin 3.

3.5mm stereo audio jack plugs are frequently sold as pre-wired sealed modules. It may be necessary to use a multi-meter to determine the wiring connections from an available plug. Typically 3 (common to both relays) is the cable screen.

### 12.14.14 LAN Port

These ports are found on IP Office control units. They are used for connection to IP LANs and IP devices.

All IP Office LAN ports are 10/100Mbps auto-sensing. Operation varies as follows:

- **IP Office 500 / IP500 V2**

The ports are full-duplex 10/100Mbps auto-sensing, MDI crossover ports. They form a managed layer 3 Ethernet switch. The WAN port is not supported on systems running in IP Office Basic Edition - PARTNER® Mode, IP Office Basic Edition - Norstar Mode or IP Office Basic Editions.



The LEDs are used as follows:

- Green: On = connected, Flashing = Activity.
- Yellow: On = 100Mbps, Off = 10Mbps.

#### LAN Cables

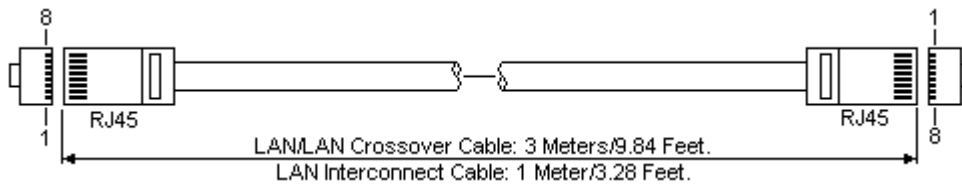
These are CAT5 UTP cables for connection of various IP devices within the IP Office system.



IP Office							
LAN	Pin	MDIX (Normal)	MDI (Crossover)	Wire	Standard/ Interconnect	Crossover	
	1	← Rx-A.	→ Tx-A.	White/Orange	1	3	
	2	← Rx-B.	→ Tx-B.	Orange/White	2	6	
	3	→ Tx-A.	← Rx-A.	White/Green	3	1	
	4	Not used.	Not used.	Blue/White	4	4	
	5	Not used.	Not used.	White/Blue	5	5	
	6	→ Tx-B.	← Rx-B.	Green/White	6	2	
	7	Not used.	Not used.	White/Brown	7	7	
	8	Not used.	Not used.	Brown/White	8	8	

- **SAP Code:**

- **LAN Cable - GREY: 700213481.**  
Standard straight LAN cable.
- **LAN Crossover Cable - Black: 700213473.**  
LAN crossover cable.

## 12.14.15 PF Port

These ports are found on the rear of the [Analog Trunk 16 expansion module](#)<sup>[22]</sup>. They are analog extension ports that can be used in conjunction with analog loop-start trunks during power failure to the IP Office system. See also [Emergency and Power Failure Ports](#)<sup>[49]</sup>.

Any phones connected to these ports should be clearly labeled as power fail extensions in accordance with the appropriate national and local regulatory requirements.

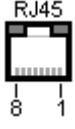
PF	Pin	Description
 A diagram of an RJ45 port with pins 1 through 8 labeled. Pin 1 is on the right and pin 8 is on the left.	1	Not used.
	2	Pin 2 is internally connected to pin 5 via a ringer capacitor.
	3	Not used.
	4	Ring.
	5	Tip.
	6	Pin 6 is internally connected to pin 5 via a ringer capacitor.
	7	Not used.
	8	Not used.

- Minimum Wire Size: AWG 26.
- Maximum Cable Length:
  - AWG26: 500m / 1640'.
  - AWG24, AWG22: 1000m / 3280'.

### 12.14.16 PHONE (POT) Port

These ports are analog extension ports. On older IP Office units these ports were labeled as POT ports rather than PHONE ports.

PHONE ports on Phone V1/V2 expansion modules can be connected to [out-of-building extensions](#)<sup>[36]</sup>. If this is the case, connection must be made via suitable protective devices (IP Office Barrier Box) at each end and via each building primary protection. In addition the Phone module must be connected to a protective ground.

PHONE ports on IP Office control units must not be connected to out-of-building extensions.

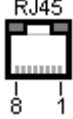
PHONE	Pin	Description
	1	Not used.
	2	Not used.
	3	Not used.
	4	Ring.
	5	Tip.
	6	Not used.
	7	Not used.
	8	Not used.



- REN: 2
- Off-Hook Current: 25mA.
- Ring Voltage:
  - IP500 V2 Control Unit, IP500 Phone Modules: 49V rms.
- Minimum Wire Size: AWG 26.
- Maximum Cable Length:
  - AWG26: 0.5km / 1640 feet.
  - AWG24, AWG22: 1km / 3280 feet.

These ports do not include a ringing capacitor. Therefore, for connection to 4-wire analog phones where this is a requirement (typically the United Kingdom and New Zealand), connection should be via a Master socket containing ringing capacitors.

#### Structured Cabling Line Cord

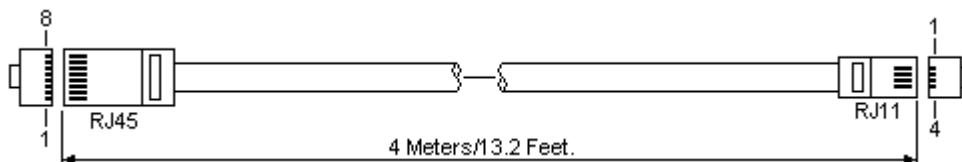
This is an RJ45 to RJ11 cable suitable for connection from a structured cabling system RJ45 port to a DS phone. It can also be used for two-wire analog phone extensions.



IP Office		Phone		
DS Port	Pin	Description	Pin	Port
	1	Not used.	-	
	2	Not used.	1	
	3	Not used.	2	
	4	Signal 1.	3	
	5	Signal 2.	4	
	6	Not used.	5	
	7	Not used.	6	
	8	Not used.	-	

## 12.14.17 PRI Port

These ports are used for connection to PRI trunk services including E1, T1 and E1-R2.

### PRI Trunk Cable

This cable is used to connect from IP Office PRI trunk ports to the line providers network termination equipment. If that equipment does not use RJ45 sockets, the cable may need to be stripped and rewired or an alternate cable used. The appropriate signal pin-outs and wire colours are detailed below.

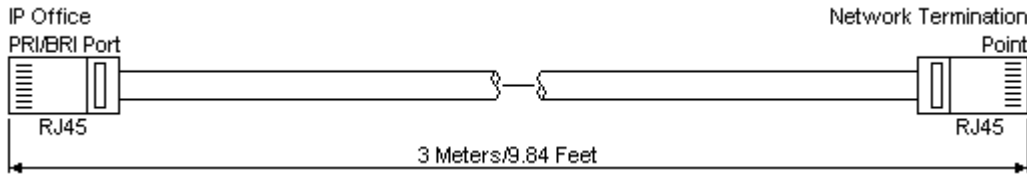

IP Office		Wire	Network Termination	
RJ45	PRI		PIN	RJ45
	1	← Rx-A	White/Orange	1
	2	← Rx-B	Orange/White	2
	3	-	White/Green	3
	4	→ Tx-A	Blue/White	4
	5	→ Tx-B	White/Blue	5
	6	-	Green/White	6
	7	-	White/Brown	7
	8	-	Brown/White	8

- Supply: PRI trunks cards are not supplied with these cables.
- Cable Color: Red.
- SAP Code: 700213440.
- Standard Length: 3m/9'10".

## 12.14.18 RS232 Port (DTE)

These ports are found on the rear of all IP Office control units and external expansion modules. The similar ports on external expansion modules are only used by Avaya.

The RS232 DTE ports can be used for a number of [system maintenance processes](#)<sup>[185]</sup>. An asynchronous terminal program such as HyperTerminal is also required. Configure this for operation via a PC serial port, as follows:

<b>Bits per second</b>	38,400	<b>Parity</b>	None	<b>Flow Control</b>	None
<b>Data bits</b>	8	<b>Stop Bits</b>	1	<b>Settings   Emulation</b>	TTY

### DTE Cables

These cables are used for system maintenance and diagnostics under Avaya guidance. They can also be used for connection of RS232 serial terminal adaptor equipment to the IP Office control unit. The cable required depends on the IP Office control unit. This cable is a "Straight through DB9 female to DB9 male serial cable".

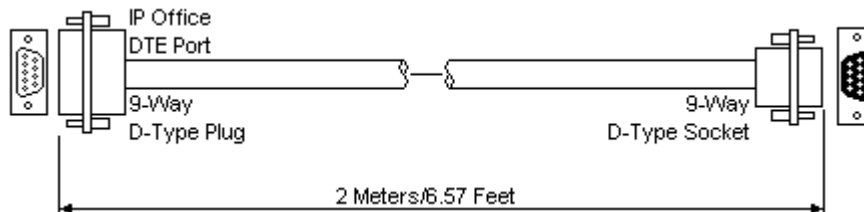

IP Office 9-Way RS232 DTE Port	Signal	PC/Terminal Adaptor
3	← Receive data	3
2	→ Transmit Data	2
7	← RTS (Request To Send)	7
8	→ CTS (Clear To Send)	8
6	→ DSR (Data Set Ready)	6
5	● Ground	5
1	→ DCD (Data Carrier Detect)	1
4	← DTR (Data Terminal Ready)	4
9	→ RI (Ring Indicator)	9

---

## 12.15 Licences

This section covers current licenses used IP500 V2 IP Office systems. It does not include details of license use other types of IP Office systems such as Server Edition.

Various IP Office features and applications require entry of [licenses](#)<sup>[368]</sup> into the system's configuration. The licenses are unique 32-character codes based on the feature being activated and the serial number of the [System SD](#)<sup>[196]</sup> card installed with the IP Office system. The serial number is printed on the System SD card and prefixed **FK**. It can also be viewed in the system configuration using IP Office Manager.

When a license is entered into the IP Office configuration, the following information is shown.

- **Status**

The status, which is **Unknown** until the configuration file is sent back to the IP Office system.

- **Unknown**

This status is shown for licenses that have just been added to the configuration shown in IP Office Manager. Once the configuration has been sent back to the IP Office and then reloaded, the status will change to one of those below.

- **Valid**

The features licensed can be configured and used.

- **Invalid**

The license was not recognized. It did not match the serial number of the System SD card.

- **Dormant**

The license is valid but is conditional on some other pre-requisite that is not currently meet.

- **Obsolete**

The license is valid but is one no longer used by the level of software running on the system.

- **Expired**

The license has passed its expiry date.

- **License**

The name of the licensed feature. This may differ from the ordered RFA name.

- **Instances**

Depending on the license, this may be the number of ports enabled or number of simultaneous users of the licensed feature. Sometime the number of instances is specified in the license name.

- **Expires**

Most purchased licenses have no expiry setting. For some features, trial licenses may be available which will have an expiry date.



## 12.15.1 System Edition Licenses

These license are used to set what range of features the IP Office system supports.

- **Essential Edition :**

The system requires this license to run in IP Office Essential Edition mode. It is also a pre-requisite to the **Preferred Edition** license. This license is not required for systems running IP Office Basic Edition - PARTNER® Mode, IP Office Basic Edition - Norstar Mode or IP Office Basic Edition modes.

- **Essential Edition Additional Voicemail Ports :**

For IP500 V2 only. Unlicensed, the Embedded Voicemail provided by the system supports 2 simultaneous connections and 15 hours of storage. This can be expanded up to 6 channels by the addition of licenses, each of which enables an additional two channels. For IP Office Release 7.0+ each license also enables an additional 5 hours of storage.

- **Preferred Edition (Voicemail Pro) :**

This license enables support for Voicemail Pro as the IP Office's voicemail server with 4 voicemail ports. The **Preferred Edition** license allows the voicemail server to provide the services listed below. For IP Office Release 8.0 and higher, an **Essential Edition** license is a pre-requisite for this license on IP500 V2 systems.

- Mailboxes for all users and hunt groups.
- Announcements for users and hunt groups.
- Customizable call flows.
- Call recording to mailboxes.
- Campaigns.
- TTS email reading for users licensed to **Mobile Worker** or **Power User** profiles. Also requires TTS licenses.
- Use of **Conference Meet Me** functions.
- Database access (*Windows based Voicemail Pro only*)
- Visual basic scripting (*Windows based Voicemail Pro only*)

1. For IP Office Release 8.0 and higher, a **Preferred Edition** [system license](#)<sup>[369]</sup> is a pre-requisite for any user profile licenses.

- In a Small Community Network, the **Preferred Edition** license of the central system is automatically shared with other systems in the network, enabling user profile licenses on those other systems. However, each system supporting a Voicemail Pro server still requires its own **Preferred Edition** license for Voicemail Pro operation.

2. For a IP500 V2 system fitted with an Unified Communications Module, the presence of the card acts as an automatic **Preferred Edition** license.

- **Branch System**

This license enables support for enterprise branch features. These relate to an IP Office system being used as a branch site switch in an Avaya Aura network. Additional **SM Trunk** licenses are required for the SM lines configured between the branch and the Avaya Aura.

---

## 12.15.2 Upgrade Licenses

Existing IP Office systems being upgraded to IP Office Release 6.0 or higher may require a software upgrade license.

- **! Warning: Upgrade License Requirements**

On a new system, when the first call is made, the software level being run is written into the control unit's permanent memory. Any subsequent upgrade to a higher release may require a software upgrade licence. Systems upgraded without the appropriate upgrade license display "*No license available*" on some phones and will not allow any telephony functions.

- **! Note: Server Edition Systems**

IP500 V2 control units configured as IP500 V2 Expansion System systems are upgraded through the Server Edition web management menus. Refer to the Server Edition documentation.

- **Software Upgrade**

Existing IP Office systems being upgraded to IP Office Release 6.0 or higher require an upgrade license suitable for the target software level.

- IP Office Basic Edition mode systems are automatically configured with either 48 or 100 users and so cannot use a **Small System Upgrade License**.
- Pre-IP Office Release 8.0 IP500 V2 systems being upgraded to IP Office Release 8.0 or higher also require a **Essential Edition**<sup>[369]</sup> system license in order to operate. A virtual Essential Edition license is automatically added to the system configuration in response to the addition of a valid upgrade license.

- **Small System Upgrade License:**

This license can be used to upgrade systems with up to 32 users and no external expansion modules.

- **Large System Upgrade License:**

This license can be used to upgrade system with more than 32 users or with external expansion modules.

## 12.15.3 Trunk Licensing

The following trunks licenses can be used by a IP500 V2 system.

- **IP500 Universal PRI (Additional channels)**

These licenses are used to enable additional B-channels above the basic 8 on an IP500 PRI-U card. The IP500 PRI-U card supports E1, T1 and E1-R2 PRI modes. The IP Office system supports 8 unlicensed B-channels on each IP500 PRI-U port fitted. Additional B-channels, up to the capacity of ports installed and PRI mode selected require licenses. These additional channels consume licenses based on which additional channels are configured as in-service from port 9 of slot 1 upwards. D-channels are not affected by licensing. The license is available in 2, 8 and 22 channel variants which can be combined for the total number of channels required.

- **SIP Trunk Channels**

These licenses are used to configure the maximum number of simultaneous SIP trunk calls supported. The licenses are consumed by calls in progress on a SIP channel. For SIP support the system also requires [VCM resources](#)<sup>[212]</sup>. The license is available in 1, 5, 10 and 20 channel variants which can be combined for the total number of channels required.

- **IP500 Voice Networking**

These licenses enable support for SCN, QSIG and H323 IP trunks. For voice networking support, the system also requires [VCM resources](#)<sup>[212]</sup>.

- **SM Trunk Channels**

These licenses are used to enabled SM lines for connection to an Avaya Aura network. The IP Office system also requires a **Branch System** license.

---

## 12.15.4 Telephone/Endpoint Licenses

The use of H323 and SIP phones with IP Office Release 6.0+ is controlled by the following licenses. Different licenses are used for Avaya IP phones, non-Avaya phones (including non-Avaya softphones) and Avaya softphones.

On IP500 V2 systems, by default these licenses are consumed by each IP phone that registers with the IP Office in the order that the phones register. The license is released if the phone unregisters. However, on Server Edition systems, these licenses are consumed by each configured IP extension whether registered or not. It is possible to reserve a license for a particular extension in order to ensure that phone always obtain a license first if available. This is done through the **Reserve Avaya IP Endpoint Licence** or **Reserve 3rd Party IP Endpoint Licence** setting of the IP extension record in the system configuration.

-  **Warning**

Avaya IP phones without a license are still able to register but are limited to making emergency calls only (Dial Emergency short code calls). The associated user is treated as if logged off and the phone may display "No license available" and "Emergency Calls Only". If a license becomes available, it is assigned to any unlicensed DECT handsets first and then to any other unlicensed Avaya IP phone in the order that the phones registered.

- **Avaya IP Endpoints License**

These licenses are used to license additional Avaya IP phones. This includes all 1600, 4600, 5600, 9600, IP DECT, DECT R4, T3 IP, Spectralink and VPN phones supported by IP Office Release 6.0. The license is available in 1, 5 and 20 phone variants which can be combined for the total number of telephones required.

- The system automatically licenses 12 Avaya IP phones for each IP500 VCM 32 and or IP500 VCM 64 card installed in the system without requiring additional licenses to be added to the configuration. This does not apply for IP500 VCM 32 V2 and IP500 VCM 64 V2 cards or IP500 Combination cards.
- Additional Avaya IP phones are licensed either by the addition of **Avaya IP Endpoints** licenses above or the conversion of legacy **IP500 VCM Channels** licenses to **Channel Migration** licenses (see below).
- For existing IP500 systems upgraded to Release 6.0 or higher, existing VCM channels and IP500 VCM Channels license are treated as follows:
  - For each IP500 VCM 32 and IP500 VCM 64 card installed in the system, the 4 unlicensed VCM channels previously provided by each card are converted to allow unlicensed support of 12 Avaya IP phones. This does not apply for IP500 VCM 32 V2 and IP500 VCM 64 V2 cards and IP500 Combination cards.
  - For each legacy **IP500 VCM Channels** license, the license are converted **Channel Migration** licenses supporting 3 Avaya IP phones. See the Channel Migration license below.
- The number of channels provided by an IP500 VCM 32 or IP500 VCM 64 card, up to a maximum of 32 or 64 respectively, depends on the actual codecs being used. Refer to [IP500 VCM](#) <sup>[212]</sup>.

- **3rd Party IP Endpoints License**

These licenses are used for support of non-Avaya IP phones including SIP extensions. The available license are used in order of phone registration. If no licenses are available the phone is not able to register. This license was previously called the **IP End-points** license. The license is available in 1, 5 and 20 phone variants which can be combined for the total number of telephones required.

- **IP Mac Softphone**

This license is used for the Mac IP Office Video SoftPhone Version 4.0. The user must also be enabled by [user licenses](#) <sup>[373]</sup> as a **Power User** or **Teleworker** user. The Mac IP Office Video SoftPhone Version 4.0 can also use legacy softphone licenses, see below.

## Legacy Endpoint Licenses

- **Legacy Softphone**





For systems upgraded to IP Office Release 9.1, a Legacy Softphone license is created for each **Power User**, **Teleworker**, **Upgrade Mobile Worker to Power User** and **Upgrade Office Worker to Power User** license in the system. This license is used for legacy Version 3.2 softphones. It can also be used for Version 4.0 softphones if no further **IP Mac Softphone** licenses are available.

- **Channel Migration**

These licenses were previously called IP500 VCM Channels. In pre-IP Office Release 6.0 systems, these license were used to enable additional VCM channels on IP500 VCM 32 and IP500 VCM 64 cards. For IP Office Release 6.0 these license are no longer required. Any present in the configuration of systems upgraded to IP Office Release 6.0 are renamed Channel Migration. Each Channel Migration license instance enables support for 3 Avaya IP phones.

## 12.15.5 User Licenses

The features available to a basic user can be enhanced by the addition of 'User Profile' licenses. Once these licenses are present in the system configuration, the profiles can be applied to selected users through the User | User | Profile setting in the system configuration.

	 Basic User	 Office Worker	 Teleworker	 Mobile Worker	 Power User
<b>one-X Portal Services</b>	✓*	✓	✓	–	✓
<b>" Telecommuter options</b>	✓*	–	✓	–	✓
<b>UMS Web Services</b>	✓*	✓	✓	–	✓
<b>Mobility Features</b> [2]	✓*	–	–	✓	✓
<b>TTS for Email Reading</b>	–	–	–	✓	✓
<b>Remote Worker</b> [3]	–	–	✓	–	✓
<b>Avaya Communicator</b> [4]	–	✓	–	–	✓
<b>IP Office Video SoftPhone</b> [6]	–	–	✓	–	✓
<b>Web Collaboration</b> [7]	–	✓	✓	–	✓

- \* These features are supported for **Basic User** users on upgraded systems with the appropriate pre-IP Office 6.0 legacy licenses.
- For IP Office Release 8.0 and higher, a **Preferred Edition system license** [369] is a pre-requisite for any user profile licenses.
    - In a Small Community Network, the **Preferred Edition** license of the central system is automatically shared with other systems in the network, enabling user profile licenses on those other systems. However, each system supporting a Voicemail Pro server still requires its own **Preferred Edition** license for Voicemail Pro operation.
  - For IP Office Release 8.0, the mobility features are enabled for all users by the **Essential Edition** system license.
  - IP Office Release 8.0 supports users using remote H323 extensions. supports users using remote H323 extensions. Up to 4 Basic users are supported on remote extensions on system without needing to be licensed, ie. not configured and licensed for a user profile. Additional remote users are supported if licensed and configured for either a **Teleworker** or **Power User** user profile.
  - Supported for advanced Avaya Communicator usage if one-X Portal for IP Office and Voicemail Pro applications are also installed. If otherwise, only basic Avaya Communicator usage is supported.
  - TTS for Email Reading also requires the voicemail system to be licensed for the number of simultaneous TTS session required.
  - For IP Office Release 9.1, IP Office Video SoftPhone also requires a specific **Legacy Softphone** or **IP Mac Softphone** license for the application, see [Telephone/Endpoint Licenses](#) [372].
  - Also requires a **Web Collaboration** license.

### Licenses

- **Teleworker Profile License**  
These licenses set the number of users who can have their profile set as **Teleworker**. For user with this optional, additional settings are enabled in the configuration for the following services: one-X Portal for IP Office with Telecommuter option and UMS Web Services. A **Preferred Edition system license** [369] is a pre-requisite. This license is available in 1, 5 and 20 user variants which can be combined for the total number of users needing to be licensed.
- **Mobile Worker Profile License**  
These licenses set the number of users who can have their profile set as **Mobile Worker**. For user with this optional, additional settings are enabled in the configuration for the following services: Mobility Features and TTS for Email Reading. For IP Office Release 8.0 and higher, all mobility features are enabled for all users by the **Essential Edition** license. This license is available in 1, 5 and 20 user variants which can be combined for the total number of users needing to be licensed.
- **Office Worker Profile License**  
These licenses set the number of users who can have their profile set as **Office Worker**. For user with this optional, additional settings are enabled in the configuration for the following services: one-X Portal for IP Office (no telecommuter features) and UMS Web Services. If no Office Worker Profile licenses are present, existing legacy Phone Manager Pro (per seat) licenses can be used to enable users for the Office Worker profile but without Avaya Communicator. A **Preferred Edition system license** [369] is a pre-requisite. This license is available in 1, 5 and 20 user variants which can be combined for the total number of users needing to be licensed.

---

- **Power User Profile License**

These licenses set the number of users who can have their profile set as **Power User**. For user with this optional, the same additional services as for Teleworker and Mobile Worker are enabled for the user. A **Preferred Edition system license** <sup>(369)</sup> is a pre-requisite. This license is available in 1, 5 and 20 user variants which can be combined for the total number of users needing to be licensed.

- **User Profile Upgrade Licenses**

These licenses can be used to upgrade existing user profile licenses. A **Preferred Edition system license** <sup>(369)</sup> is a pre-requisite. This license is available in 1 and 5 user variants which can be combined for the total number of users needing to be licensed.

## Other User Licenses

In addition to the user profile licenses above, the following individual user licenses are available:

- **Receptionist:**

This license is used to enable support for the IP Office SoftConsole application. This license can only be used by users set to **Receptionist** in the IP Office configuration. A maximum of 4 receptionist are supported. This license was previously called **SoftConsole**.

- For IP Office Release 6.0 and 6.1, an instance of this license is consumed by each user configured as a **Receptionist**. If the user hot desks to another IP Office system in an SCN, their license entitlement is retained, ie. the remote system does not require a **Receptionist** license.
- For IP Office Release 7.0+, instances of this license are only consumed when the user is using the IP Office SoftConsole application. If the user hot desks to another IP Office system in an SCN, that system requires an available license in its configuration.

- **Avaya Softphone:**

This license can be used to enable support for basic Avaya Communicator usage on IP500 V2 systems when either one-X Portal for IP Office or Voicemail Pro is not available. The license can be used with any user profile including **Basic User**. This license is not used for the IP Office Video SoftPhone application.

- **Web Collaboration**

This license can be used to enable support for the [Web Collaboration application](#)<sup>[348]</sup>. One license instance is required for each user configured for web collaboration. Supported with users licensed as **Office Worker**, **Teleworker** or **Power User**.

---

## 12.15.6 Voicemail Pro Licenses

For IP Office Release 6.0 and higher, support for Voicemail Pro is enable by the addition of the following licenses.

- **Preferred Edition (Voicemail Pro) :**

This license enables support for Voicemail Pro as the IP Office's voicemail server with 4 voicemail ports. The **Preferred Edition** license allows the voicemail server to provide the services listed below. For IP Office Release 8.0 and higher, an **Essential Edition** license is a pre-requisite for this license on IP500 V2 systems.

- Mailboxes for all users and hunt groups.
- Announcements for users and hunt groups.
- Customizable call flows.
- Call recording to mailboxes.
- Campaigns.
- TTS email reading for users licensed to **Mobile Worker** or **Power User** profiles. Also requires TTS licenses.
- Use of **Conference Meet Me** functions.
- Database access (*Windows based Voicemail Pro only*)
- Visual basic scripting (*Windows based Voicemail Pro only*)

1. For IP Office Release 8.0 and higher, a **Preferred Edition [system license](#)** <sup>[369]</sup> is a pre-requisite for any user profile licenses.

- In a Small Community Network, the **Preferred Edition** license of the central system is automatically shared with other systems in the network, enabling user profile licenses on those other systems. However, each system supporting a Voicemail Pro server still requires its own **Preferred Edition** license for Voicemail Pro operation.

2. For a IP500 V2 system fitted with an Unified Communications Module, the presence of the card acts as an automatic **Preferred Edition** license.

- **Preferred Edition Additional Voicemail Ports**

The required license for Voicemail Pro server support (Preferred Edition (Voicemail Pro)) also enables 4 voicemail ports. These licenses can be used to add additional voicemail ports up to the maximum capacity of the IP Office system (IP500 V2 = 40). This license was previously called **Additional Voicemail Pro (ports)**. These licenses are available in 2, 4, 8 and 16 port variants which can be combined for the total number of ports required.

- **VMPro Recordings Administrators :**

To support ContactStore in a Small Community Network, IP Offices other than the central IP Office require either their own license.

- **VMPro Networked Messaging :**

Enables VPNM (Voicemail Pro Networked Messaging) functionality within Voicemail Pro. This allows message exchange with remote Voicemail Pro systems and Avaya Interchange systems.

- **VMPro TTS (Generic) :**

This legacy license enables the use of text to speech facilities using third party TTS software with Voicemail Pro on a Windows server. One license per simultaneous instance of TTS usage. Note that the IP Office Advance Edition license also enables 8 ports of generic TTS but useable with Speak Text actions only.

- **VMPro TTS (ScanSoft) :**

This legacy license enables the use of text to speech facilities using Avaya supplied TTS software with Voicemail Pro on a Windows server. One license per simultaneous instance of TTS usage.

- **VMPro TTS Professional :**

This license enables the use of text to speech facilities provided by Voicemail Pro on a Linux based server. One license per simultaneous instance of TTS usage.

- **UMS Web Services**

These licenses are used to enable UMS voicemail services support for users set to the **Basic User** profile. Other users are enabled for UMS through their licensed user profile. These licenses are also used to license hunt groups for UMS voicemail services. Each license enables 1 user.



## Legacy Voicemail Licenses

The following legacy licenses are still supported by IP Office Release 6.0 and higher.

- **UMS Web Services**

These licenses are used to enable UMS voicemail services support for users set to the **Basic User** profile. Other users are enabled for UMS through their licensed user profile. These licenses are also used to license hunt groups for UMS voicemail services. Each license enables 1 user.

---

## 12.15.7 Trial Licenses

The following trial licenses can be requested. Each is valid for 60 days from the date of issue and can only be issued once for a particular System SD card serial number. Apart from that restriction, the trial licenses work the same as full licenses.

- **Essential Edition**
- **Preferred Edition**
- **Power User (5 Users)**
- **Teleworker (5 Users)**
- **Mobile Worker (5 Users)**
- **Office Worker (5 Users)**
- **Customer Service Agent**
- **Customer Service Supervisor**
- **Avaya IP Endpoints License (5 Extensions)**
- **3rd Party IP Endpoints (5 Extensions)**
- **Receptionist (1 User)**
- **VMPro Networked Messaging**
- **VMPro TTS (ScanSoft)**
- **VM Pro TTS (Generic)**
- **VMPro TTS Professional (Linux)**
- **Audix Voicemail**
- **IPSec Tunneling**
- **SIP Trunk Channels**
- **IP500 Voice Networking**
- **CTI Link Pro**

- \* All new IP500 V2 systems are supplied with these indicated licenses, which are valid for 90-days from the first call on the system.

## 12.15.8 CTI Licenses

- **CTI Link Pro :**  
Enables CTI Link Pro functionality (TAPI Link Pro and DEVLink Pro).
- **Wave User :**  
Allows streaming of WAV files, using TAPILink Pro, for 3rd party voice applications. This is a per user license. Note that TAPI WAV calls use system data channels taken from the same pools as used for voicemail ports. The maximum number of simultaneous TAPI WAV user calls and voicemail users is determined by the IP Office control unit type; IP500 V2 =40.

## 12.15.9 Other Licenses

- **Audix Voicemail :**  
Enables IP Office to use a remote Intuity Audix or Modular Messaging system for voicemail rather than requiring a local voicemail server.
- **IPSec Tunneling :**  
Enables the IP Office to initiate and terminate IPSec and L2TP tunnels.
- **Avaya Contact Center Select**  
This license is required for the support of Avaya Contact Center Select with IP Office Release 9.1.

## Legacy Licenses

The following licenses are no longer available from Avaya but are still supported for systems upgraded to IP Office 9.1:

- **Mobility Features**  
These legacy licenses were used to enable mobility features, for example mobile twinning or mobile call control, for users set to the **Basic User** profile. For IP Office Release 8.0 and higher, the mobile twinning mobility feature is automatically enabled for all users. This license was available in 1, 5 and 20 user variants which can be combined for the total number of users enabled.
- **one-X Portal for IP Office**  
These legacy licenses were used to enable one-X Portal for IP Office support for users set to the **Basic User** profile. The licenses were purchased as part of the IP Office 5 Power User license packages.
- **UMS Web Services**  
These licenses are used to enable UMS voicemail services support for users set to the **Basic User** profile. Other users are enabled for UMS through their licensed user profile. These licenses are also used to license hunt groups for UMS voicemail services. Each license enables 1 user.
- **Advanced Edition:**  
This legacy license is only supported for existing systems upgraded to IP Office Release 9.1. The **Essential Edition** and **Preferred Edition** licenses are a pre-requisite for this license. It enables the additional features listed below. Other features previously enabled by this license are now enabled by the **Preferred Edition** license.
  - Voicemail Pro call recording to ContactStore.<sup>[3]</sup>
  - Voicemail Pro call flow generic TTS (8 ports).<sup>[1][2]</sup>
    1. Only supported on Windows based Voicemail Pro servers.
    2. Provides up to 8 ports of generic TTS for use with Speak Text actions within Voicemail Pro call flows. Not used for user TTS email reading. Not supported for Linux based voicemail servers.
    3. Note: In a Small Community Network using centralized voicemail, this license only enables ContactStore support for the central IP Office. Remote IP Offices in the network require their own **Advanced Edition** license or a **VMPRO Recordings Administrator** licenses.

## 12.16 Hardware/Software Compatibility

This page summarizes the hardware and software components supported on different releases of IP Office core software.

- [Controls Units](#) <sup>[386]</sup>
- [External Expansion Modules](#) <sup>[387]</sup>
- [Base and Trunk Cards](#) <sup>[382]</sup>
- [Phones](#) <sup>[383]</sup>
- [Applications](#) <sup>[387]</sup>

### Control Units

Control Unit	Material Code	4.0	4.1	4.2	5.0	6.0	6.1	7.0	8.0	8.1	9.0	9.1
<b>Small Office Edition</b>	-	✓	✓	✓	-	-	-	-	-	-	-	-
<b>IP403</b>	700350382	-	-	-	-	-	-	-	-	-	-	-
<b>IP406 V1</b>	700210776	-	-	-	-	-	-	-	-	-	-	-
<b>IP406 V2</b>	700359946	✓ <sup>[1]</sup>	✓ <sup>[1]</sup>	✓ <sup>[1]</sup>	✓ <sup>[1]</sup>	✓ <sup>[1]</sup>		-	-	-	-	-
<b>IP412</b>	700350408	✓	✓	✓	✓	✓	✓	-	-	-	-	-
<b>IP500 (version 1)</b>	700417207	✓	✓	✓	✓	✓	✓	✓	✓	✓	✓	-
<b>IP500 V2</b>	700476005	-	-	-	-	✓	✓	✓	✓	✓	✓	✓
<b>R220/R620 Server Edition</b>	302788/ 306961	-	-	-	-	-	-	-	-	-	✓	✓
<b>R220 UC APP/FT</b>	302786/ 302787	-	-	-	-	-	-	-	-	✓ <sup>[2]</sup>	✓ <sup>[2]</sup>	✓
<b>DL120 UC APP/FT</b>	269810/ 270391	-	-	-	-	-	-	-	-	✓ <sup>[2]</sup>	✓ <sup>[2]</sup>	-
<b>DL360/DL120/R210 Server Edition</b>	270393/ 270395/ 303788	-	-	-	-	-	-	-	-	✓	✓	-

1. For an IP406 V2 control unit to run IP Office Release 4.0 or higher software up to IP Office Release 6.1, the control unit must be PCS 8 or higher.

2. Requires reimaging the server: Ensure the capacities are within the server capabilities for the application.

## External Expansion Modules

Module	Material Code	4.0	4.1	4.2	5.0	6.0	6.1	7.0	8.0	8.1	9.0	9.1
IP400 ATM16	700211360	✓	✓	✓	✓	✓	✓	✓	✓	✓	✓	✓ <sup>[6]</sup>
IP400 DS16	700184807	✓	✓	✓	✓	✓	✓	✓	✓	✓	✓	–
IP400 DS30	700184880	✓	✓	✓	✓	✓	✓	✓	✓	✓	✓	–
IP400 DS16 V2	700359839	✓	✓	✓	✓	✓	✓	✓	✓	✓	✓	✓ <sup>[6]</sup>
IP400 DS30 V2 <sup>[4]</sup>	700359847	✓	✓	✓	✓	✓	✓	✓	✓	✓	✓	✓ <sup>[6]</sup>
IP400 Phone 8	700184773	✓	✓	✓	✓	✓	✓	✓	✓	✓	✓	–
IP400 Phone 16	700184781	✓	✓	✓	✓	✓	✓	✓	✓	✓	✓	–
IP400 Phone 30	700184799	✓	✓	✓	✓	✓	✓	✓	✓	✓	✓	–
IP400 Phone 8	700359896	✓	✓	✓	✓	✓	✓	✓	✓	✓	✓	–
IP400 Phone 16 V2	700359904	✓	✓	✓	✓	✓	✓	✓	✓	✓	✓	✓ <sup>[6]</sup>
IP400 Phone 30 V2	700359912	✓	✓	✓	✓	✓	✓	✓	✓	✓	✓	✓ <sup>[6]</sup>
IP400 So8	700185077	✓	✓	✓	✓	✓	✓	✓	✓	✓	✓	–
IP400 WAN3 <sup>[1]</sup>	–	–	–	–	–	–	–	–	–	–	–	–
IP400 WAN3 10/100 <sup>[1]</sup>	700262009	✓	✓	✓	✓	✓	✓	–	–	–	–	–
IP500 ATM16 <sup>[2]</sup>	700449473	✓	✓	✓	✓	✓	✓	✓	✓	✓	✓	✓
IP500 So8	700449515	✓	✓	✓	✓	✓	✓	✓	✓	✓	✓	✓
IP500 DS16	700449499	✓	✓	✓	✓	✓	✓	✓	✓	✓	✓	✓
IP500 DS30	700426216	✓	✓	✓	✓	✓	✓	✓	✓	✓	✓	✓
IP500 DS16A (RJ21) <sup>[6]</sup>	700500699	–	–	–	–	–	–	✓	✓	✓	✓	✓
IP500 DS30A (RJ21) <sup>[6]</sup>	700500698	–	–	–	–	–	–	✓	✓	✓	✓	✓
IP500 DS16B <sup>[5]</sup>	700501585	–	–	–	–	–	–	–	–	✓	✓	✓
IP500 DS30B <sup>[5]</sup>	700501586	–	–	–	–	–	–	–	–	✓	✓	✓
IP500 Phone 16 V2	700449507	✓	✓	✓	✓	✓	✓	✓	✓	✓	✓	✓
IP500 Phone 30 V2	700426224	✓	✓	✓	✓	✓	✓	✓	✓	✓	✓	✓

1. Not supported on IP500 and IP500 V2 systems.

2. North America only, unless accepted in targeted country.

3. IP500 V2 systems only.

4. A maximum of sixteen 4424D telephones are supported on an IP400 DS30 V2 unless PCS05 or higher. PCS05 and higher units can support up to twenty-seven 4424D telephones.

5. IP500 (DS only) and IP500 V2 (DS or TCM). For IP Office Release 8.1 Service Pack 9 and higher these modules support DS ports only.

6. These IP400 variants are still supported on IP Office Release 9.1.

## Base and Cards

Base Cards	Material Code	4.0	4.1	4.2	5.0	6.0	6.1	7.0	8.0	8.1	9.0	9.1
IP500 Phone 2	700431778	✓	✓	✓	✓	✓	✓	✓	✓	✓	✓	✓
IP500 Phone 8	700417231	✓	✓	✓	✓	✓	✓	✓	✓	✓	✓	✓
IP500 Digital Station 8	700417330	✓	✓	✓	✓	✓	✓	✓	✓	✓	✓	✓
IP500 Card Carrier	700417215	✓	✓	✓	✓	✓	✓	✓	✓	✓	✓	-
IP500 VCM 32	700417389	✓	✓	✓	✓	✓	✓	✓	✓	✓	✓	✓
IP500 VCM 64	700417397	✓	✓	✓	✓	✓	✓	✓	✓	✓	✓	✓
IP500 VCM 32 V2	700504031	-	-	-	-	-	-	-	-	✓	✓	✓
IP500 VCM 64 V2	700504031	-	-	-	-	-	-	-	-	✓	✓	✓
IP500 4-Port Expansion	-	-	-	-	✓	✓	✓	✓	✓	✓	✓	✓
IP500 ETR6 <sup>[1][2]</sup>	700476039	-	-	-	-	✓	✓	✓	✓	✓	✓	✓
IP500 ATM4 Combo Card <sup>[1]</sup>	700476013	-	-	-	-	✓	✓	✓	✓	✓	✓	✓
" PCS04 <sup>[388]</sup> and higher <sup>[5]</sup>	700476013	-	-	-	-	-	✓	✓	✓	✓	✓	✓
IP500 ATM4 Combo Card V2 <sup>[1]</sup>	700504556	-	-	-	-	-	-	-	-	✓	✓	✓
IP500 BRI Combo Card BRI <sup>[1]</sup>	700476021	-	-	-	-	✓	✓	✓	✓	✓	✓	✓
IP500 TCM 8 <sup>[1]</sup>	700500758	-	-	-	-	-	-	✓	✓	✓	✓	✓
Unified Communications Module v1 <sup>[1]</sup>	700501442	-	-	-	-	-	-	-	✓	✓	✓	✓
Unified Communications Module v2 <sup>[1]</sup>	700507449	-	-	-	-	-	-	-	-	-	-	✓

Trunk Cards	Material Code	4.0	4.1	4.2	5.0	6.0	6.1	7.0	8.0	8.1	9.0	9.1
IP500 Alog Trunk Card	700417405	✓	✓	✓	✓	✓	✓	✓	✓	✓	✓	✓
" PCS10 <sup>[388]</sup> and higher <sup>[4]</sup>	700417405	-	-	-	-	-	✓	✓	✓	✓	✓	✓
IP500 Alog Trunk Card V2 <sup>[1]</sup>	700503164	-	-	-	-	-	-	-	-	✓ <sup>[3]</sup>	✓	✓
IP500 BRI 4 Trunk Card	700417413	✓	✓	✓	✓	✓	✓	✓	✓	✓	✓	✓
IP500 BRI 8 Trunk Card	700417421	✓	✓	✓	✓	✓	✓	✓	✓	✓	✓	✓
IP500 PRI-1U	700417439	-	✓	✓	✓	✓	✓	✓	✓	✓	✓	✓
IP500 PRI-2U	700417462	-	✓	✓	✓	✓	✓	✓	✓	✓	✓	✓
IP500 T1(J) PRI Dual	700509377	-	-	-	-	-	-	-	-	-	-	✓

1. IP500 V2 systems only.
2. Only supported in IP Office Basic Edition - PARTNER® Mode or IP Office Basic Edition (U-Law) modes running in a North American locale.
3. Supported for 8.1 Feature Pack 1 and higher.
4. These cards are support by IP Office Release 4.0 and higher. However, PCS10 and higher cards are only supported in systems running IP Office Release 6.1(20), 7.0(12) or 8.0 and higher. Refer to IP Office Technical Tip 237.
5. These cards are supported by IP Office Release 6.0 and higher. However, PCS04 and higher cards are only supported in systems running IP Office Release 6.1(20), 7.0(12) or 8.0 and higher. Refer to IP Office Technical Tip 237.

## Phones

## 1000 Series

Phone	4.0	4.1	4.2	5.0	6.0	6.1	7.0	8.0	8.1	9.0	9.1
1010	-	-	-	-	-	✓	✓	✓	✓	✓	✓
1040	-	-	-	-	-	✓	✓	✓	✓	✓	✓

## 1100/1200 Series

Phone	4.0	4.1	4.2	5.0	6.0	6.1	7.0	8.0	8.1	9.0	9.1
1120E	-	-	-	-	-	✓	✓	✓	✓	✓	✓
1140E	-	-	-	-	-	✓	✓	✓	✓	✓	✓
1220	-	-	-	-	-	✓	✓	✓	✓	✓	✓
1230	-	-	-	-	-	✓	✓	✓	✓	✓	✓

## 1400 Series

Phone	4.0	4.1	4.2	5.0	6.0	6.1	7.0	8.0	8.1	9.0	9.1
1403	-	-	-	-	✓	✓	✓	✓	✓	✓	✓
1408	-	-	-	-	✓	✓	✓	✓	✓	✓	✓
1416	-	-	-	-	✓	✓	✓	✓	✓	✓	✓

## 1600 Series

Phone	4.0	4.1	4.2	5.0	6.0	6.1	7.0	8.0	8.1	9.0	9.1
1603 <sup>[1]</sup>	-	-	✓	✓	✓	✓	✓	✓	✓	✓	✓
1603-I	-	-	-	-	✓	✓	✓	✓	✓	✓	✓
1603SW	-	-	-	✓	✓	✓	✓	✓	✓	✓	✓
1603SW-I	-	-	-	-	✓	✓	✓	✓	✓	✓	✓
1608 <sup>[1]</sup>	-	-	✓	✓	✓	✓	✓	✓	✓	✓	✓
1608-I	-	-	-	-	✓	✓	✓	✓	✓	✓	✓
1616 <sup>[1]</sup>	-	-	✓	✓	✓	✓	✓	✓	✓	✓	✓
1616-I	-	-	-	-	✓	✓	✓	✓	✓	✓	✓

1. 4.2 Q4 '08+.

## 20 Series

Phone	4.0	4.1	4.2	5.0	6.0	6.1	7.0	8.0	8.1	9.0	9.1
2010	-	-	-	-	-	-	-	-	-	-	-
2030	-	-	-	-	-	-	-	-	-	-	-
2050	-	-	-	-	-	-	-	-	-	-	-
20CC	-	-	-	-	-	-	-	-	-	-	-
20DT	✓	✓	✓	-	-	-	-	-	-	-	-

## 2400 Series

Phone	4.0	4.1	4.2	5.0	6.0	6.1	7.0	8.0	8.1	9.0	9.1
2402D	✓	✓	✓	✓	✓	✓	✓	✓	✓	✓	✓
2410D	✓	✓	✓	✓	✓	✓	✓	✓	✓	✓	✓
2420	✓	✓	✓	✓	✓	✓	✓	✓	✓	✓	✓

## 3600 Series

Phone	4.0	4.1	4.2	5.0	6.0	6.1	7.0	8.0	8.1	9.0	9.1
3616	✓	✓	✓	✓	✓	✓	✓	✓	✓	✓	✓
3620	✓	✓	✓	✓	✓	✓	✓	✓	✓	✓	✓
3626	✓	✓	✓	✓	✓	✓	✓	✓	✓	✓	✓
3641	✓	✓	✓	✓	✓	✓	✓	✓	✓	✓	✓
3645	✓	✓	✓	✓	✓	✓	✓	✓	✓	✓	✓

## 3700 Series

Phone	4.0	4.1	4.2	5.0	6.0	6.1	7.0	8.0	8.1	9.0	9.1
3701	✓	✓	✓	✓	✓	✓	✓	✓	✓	✓	✓

Phone	4.0	4.1	4.2	5.0	6.0	6.1	7.0	8.0	8.1	9.0	9.1
3711	✓	✓	✓	✓	✓	✓	✓	✓	✓	✓	✓
3720	-	-	-	✓	✓	✓	✓	✓	✓	✓	✓
3725	-	-	-	✓	✓	✓	✓	✓	✓	✓	✓
3740	-	-	-	-	-	-	✓	✓	✓	✓	✓
3749	-	-	-	-	-	-	✓	✓	✓	✓	✓

### 3800/3900 Series

Phone	4.0	4.1	4.2	5.0	6.0	6.1	7.0	8.0	8.1	9.0	9.1
3810	✓	✓	✓	✓	✓	✓	✓	✓	✓	✓	✓
3910	-	-	-	-	✓	✓	✓	✓	✓	✓	✓
3920	-	-	-	-	✓	✓	✓	✓	✓	✓	✓

### 4100 Series

Phone	4.0	4.1	4.2	5.0	6.0	6.1	7.0	8.0	8.1	9.0	9.1
4135	-	-	-	-	-	-	✓	✓	✓	✓	✓
4136	-	-	-	-	-	-	✓	✓	✓	✓	✓
4145	-	-	-	-	-	-	✓	✓	✓	✓	✓
4145EX	-	-	-	-	-	-	✓	✓	✓	✓	✓
4146	-	-	-	-	-	-	✓	✓	✓	✓	✓
4146EX	-	-	-	-	-	-	✓	✓	✓	✓	✓

### 4400 Series

Phone	4.0	4.1	4.2	5.0	6.0	6.1	7.0	8.0	8.1	9.0	9.1
4406D	✓	✓	✓	✓	✓	✓	✓	✓	✓	✓	✓
4412D	✓	✓	✓	✓	✓	✓	✓	✓	✓	✓	✓
4424D	✓	✓	✓	✓	✓	✓	✓	✓	✓	✓	✓

### 4600 Series

Phone	4.0	4.1	4.2	5.0	6.0	6.1	7.0	8.0	8.1	9.0	9.1
4601	✓	✓	✓	✓	✓	✓	✓	✓	✓	✓	✓
4602IP	✓	✓	✓	✓	✓	✓	✓	✓	✓	✓	✓
4602SW	✓	✓	✓	✓	✓	✓	✓	✓	✓	✓	✓
4606	-	-	-	-	-	-	-	-	-	-	-
4610SW	✓	✓	✓	✓	✓	✓	✓	✓	✓	✓	✓
4612	-	-	-	-	-	-	-	-	-	-	-
4620	✓	✓	✓	✓	✓	✓	✓	✓	✓	✓	✓
4621	✓	✓	✓	✓	✓	✓	✓	✓	✓	✓	✓
4624	-	-	-	-	-	-	-	-	-	-	-
4625	✓	✓	✓	✓	✓	✓	✓	✓	✓	✓	✓

### 5400 Series

Phone	4.0	4.1	4.2	5.0	6.0	6.1	7.0	8.0	8.1	9.0	9.1
5402	✓	✓	✓	✓	✓	✓	✓	✓	✓	✓	✓
5410	✓	✓	✓	✓	✓	✓	✓	✓	✓	✓	✓
5420	✓	✓	✓	✓	✓	✓	✓	✓	✓	✓	✓

### 5600 Series

Phone	4.0	4.1	4.2	5.0	6.0	6.1	7.0	8.0	8.1	9.0	9.1
5601	✓	✓	✓	✓	✓	✓	✓	✓	✓	✓	✓
5602IP	✓	✓	✓	✓	✓	✓	✓	✓	✓	✓	✓
5602SW	✓	✓	✓	✓	✓	✓	✓	✓	✓	✓	✓
5610SW	✓	✓	✓	✓	✓	✓	✓	✓	✓	✓	✓
5620	✓	✓	✓	✓	✓	✓	✓	✓	✓	✓	✓
5621	✓	✓	✓	✓	✓	✓	✓	✓	✓	✓	✓



**7400 Series**

Phone	4.0	4.1	4.2	5.0	6.0	6.1	7.0	8.0	8.1	9.0	9.1
7420	-	-	-	-	-	-	✓	✓	✓	✓	✓
7430	-	-	-	-	-	-	✓	✓	✓	✓	✓
7434	-	-	-	-	-	-	✓	✓	✓	✓	✓
7439	-	-	-	-	-	-	✓	✓	✓	✓	✓
7440	-	-	-	-	-	-	✓	✓	✓	✓	✓
7444	-	-	-	-	-	-	✓	✓	✓	✓	✓
7449	-	-	-	-	-	-	✓	✓	✓	✓	✓

**9500 Series**

Phone	4.0	4.1	4.2	5.0	6.0	6.1	7.0	8.0	8.1	9.0	9.1
9504	-	-	-	-	-	-	✓	✓	✓	✓	✓
9508	-	-	-	-	-	-	✓	✓	✓	✓	✓

**9600 Series**

Phone	4.0	4.1	4.2	5.0	6.0	6.1	7.0	8.0	8.1	9.0	9.1
9608/9608G	-	-	-	-	-	-	-	✓	✓	✓	✓
9611G	-	-	-	-	-	-	-	✓	✓	✓	✓
9620L	-	-	-	-	✓	✓	✓	✓	✓	✓	✓
9620C	-	-	-	-	✓	✓	✓	✓	✓	✓	✓
9621G	-	-	-	-	-	-	-	✓	✓	✓	✓
9630G	-	-	-	-	✓	✓	✓	✓	✓	✓	✓
9640	-	-	-	-	✓	✓	✓	✓	✓	✓	✓
9640G	-	-	-	-	✓	✓	✓	✓	✓	✓	✓
9641G	-	-	-	-	-	-	-	✓	✓	✓	✓
9650	-	-	-	-	✓	✓	✓	✓	✓	✓	✓
9650C	-	-	-	-	✓	✓	✓	✓	✓	✓	✓

1. Release 8.0 2012 Q1 service pack and higher.

**B100 Series**

Phone	4.0	4.1	4.2	5.0	6.0	6.1	7.0	8.0	8.1	9.0	9.1
B149	-	-	-	-	-	✓	✓	✓	✓	✓	✓
B159	-	-	-	-	-	✓	✓	✓	✓	✓	✓
B169	-	-	-	-	-	✓	✓	✓	✓	✓	✓
B179	-	-	-	-	-	-	✓	✓	✓	✓	✓

**D100 Series**

Phone	4.0	4.1	4.2	5.0	6.0	6.1	7.0	8.0	8.1	9.0	9.1
D160	-	-	-	-	-	-	-	-	✓ <sup>[1]</sup>	✓	✓

1. Supported for 8.1 Feature Pack 1 and higher.

**ETR Series**

Phone	4.0	4.1	4.2	5.0	6.0	6.1	7.0	8.0	8.1	9.0	9.1
ETR6	-	-	-	-	✓	✓	✓	✓	✓	✓	✓
ETR6D	-	-	-	-	✓	✓	✓	✓	✓	✓	✓
ERT18	-	-	-	-	✓	✓	✓	✓	✓	✓	✓
ETR18D	-	-	-	-	✓	✓	✓	✓	✓	✓	✓
ETR34	-	-	-	-	✓	✓	✓	✓	✓	✓	✓
ETR34D	-	-	-	-	✓	✓	✓	✓	✓	✓	✓

**E-Series**

Phone	4.0	4.1	4.2	5.0	6.0	6.1	7.0	8.0	8.1	9.0	9.1
E129	-	-	-	-	-	-	-	-	-	✓	✓
E169	-	-	-	-	-	-	-	-	-	✓	✓

**M-Series**

Phone	4.0	4.1	4.2	5.0	6.0	6.1	7.0	8.0	8.1	9.0	9.1
M7100	-	-	-	-	-	-	✓	✓	✓	✓	✓
M7100N	-	-	-	-	-	-	✓	✓	✓	✓	✓
M7208	-	-	-	-	-	-	✓	✓	✓	✓	✓
M7208N	-	-	-	-	-	-	✓	✓	✓	✓	✓
M7310	-	-	-	-	-	-	✓	✓	✓	✓	✓
M7310N	-	-	-	-	-	-	✓	✓	✓	✓	✓
M7324	-	-	-	-	-	-	✓	✓	✓	✓	✓
M7324N	-	-	-	-	-	-	✓	✓	✓	✓	✓

#### T-Series

Phone	4.0	4.1	4.2	5.0	6.0	6.1	7.0	8.0	8.1	9.0	9.1
T7000	-	-	-	-	-	-	✓	✓	✓	✓	✓
T7100	-	-	-	-	-	-	✓	✓	✓	✓	✓
T7208	-	-	-	-	-	-	✓	✓	✓	✓	✓
T7316	-	-	-	-	-	-	✓	✓	✓	✓	✓
T7316E	-	-	-	-	-	-	✓	✓	✓	✓	✓
T7406	-	-	-	-	-	-	✓	✓	✓	✓	✓
T7406E	-	-	-	-	-	-	✓	✓	✓	✓	✓
ACU	-	-	-	-	-	-	✓	✓	✓	✓	✓

#### T3/T3IP Series

Phone	4.0	4.1	4.2	5.0	6.0	6.1	7.0	8.0	8.1	9.0	9.1
T3 Compact	✓	✓	✓	✓	✓	✓	✓	✓	✓	✓	✓
T3 Classic	✓	✓	✓	✓	✓	✓	✓	✓	✓	✓	✓
T3 Comfort	✓	✓	✓	✓	✓	✓	✓	✓	✓	✓	✓
T3 IP Compact	✓	✓	✓	✓	✓	✓	✓	✓	✓	✓	✓
T3 IP Classic	✓	✓	✓	✓	✓	✓	✓	✓	✓	✓	✓
T3 IP Comfort	✓	✓	✓	✓	✓	✓	✓	✓	✓	✓	✓

## IP Office Applications

Application	4.0	4.1	4.2	5.0	6.0	6.1	7.0	8.0	8.1	9.0	9.1
Call Detail Records (CDR)	✓	✓	✓	-	-	-	-	-	-	-	-
Conferencing Center	✓	✓	✓	✓	-	-	-	-	-	-	-
Compact Business Center	✓	✓	-	-	-	-	-	-	-	-	-
Contact Recorder	-	-	-	-	-	-	-	-	✓	✓	✓
ContactStore	✓	✓	✓	✓	✓	✓	✓	✓	✓	✓	✓
Customer Call Reporter	-	-	✓	✓	✓	✓	✓	✓	✓	✓	-
Compact Contact Center	✓	✓	✓	✓	-	-	-	-	-	-	-
Data Migration Manager	-	-	-	-	-	-	✓	✓	✓	✓	-
Delta Server	✓	✓	✓	✓	-	-	-	-	-	-	-
Avaya Communicator	-	-	-	-	-	-	-	-	✓	✓	✓
IP Office Contact Center	-	-	-	-	-	-	-	-	-	✓	✓
Manager	✓	✓	✓	✓	✓	✓	✓	✓	✓	✓	✓
MS-CRM	✓	✓	✓	✓	-	-	-	-	-	-	-
Phone Manager	✓	✓	✓	✓	✓	✓	✓	✓	✓	-	-
" Pro	✓	✓	✓	✓	✓	✓	✓	✓	✓	-	-
" Pro Softphone	✓	✓	✓	✓	✓	✓	✓	✓	✓	-	-
one-X Mobile Preferred	-	-	-	-	-	-	-	✓	✓	✓	✓
one-X Portal	-	-	-	✓	✓	✓	✓	✓	✓	✓	✓
" Call Assistant	-	-	-	-	-	✓	✓	✓	✓	✓	✓
" Lync plug-in	-	-	-	-	-	-	-	-	✓	✓	✓
" Outlook plug-in	-	-	-	-	-	-	-	✓	✓	✓	✓
" Salesforce plug-in	-	-	-	-	-	-	-	✓	✓	✓	✓
Outbound Call Express	-	-	-	-	-	-	-	-	✓	✓	✓
SoftConsole	✓	✓	✓	✓	✓	✓	✓	✓	✓	✓	✓
System Status Application	✓	✓	✓	✓	✓	✓	✓	✓	✓	✓	✓
System Monitor	✓	✓	✓	✓	✓	✓	✓	✓	✓	✓	✓
TAPI Link Lite	✓	✓	✓	✓	✓	✓	✓	✓	✓	✓	✓
TAPI Link Pro	✓	✓	✓	✓	✓	✓	✓	✓	✓	✓	✓
Integrated Messaging	✓	✓	✓	✓	✓	✓	✓	✓	✓	✓	✓
Video Softphone (Mac)	-	-	-	-	-	-	-	✓	✓	✓	✓
" (Windows)	-	-	-	-	✓	✓	✓	✓	✓	✓	✓
Voicemail Lite	✓	✓	✓	-	-	-	-	-	-	-	-
Voicemail Pro	✓	✓	✓	✓	✓	✓	✓	✓	✓	✓	✓
Web Conferencing	-	-	-	-	-	-	-	-	-	-	✓

## 12.17 Hardware PCS Levels

Each item of IP Office hardware has a Product Change Status (PCS) level. This is usually included on the label on the hardware prefix with **PCS**.

The PCS level is increased each time a significant change is made to the components of that piece of hardware. For example the PCS level may be increased when a component is replaced by one from a different supplier.

Normally changes to a PCS level are not important and items of the same hardware but with different PCS levels are still identical in operation and can be interchanged. However, there are some exceptions as listed below.

### PCS Level Restrictions

- **IP500 Analog Trunk Card V1**

These cards are supported by IP Office Release 4.0 and higher. However, PCS10 and higher cards are only supported in systems running IP Office Release 6.1(20), 7.0(12) or 8.0 and higher. Refer to IP Office Technical Tip 237.

- **IP500 ATM4 Combination Card V1**

These cards are supported by IP Office Release 6.0 and higher. However, PCS04 and higher cards are only supported in systems running IP Office Release 6.1(20), 7.0(12) or 8.0 and higher. Refer to IP Office Technical Tip 237.

- **IP500 V2 Control Unit**

To support IP Office Release 9.1 or higher, PCS 14 or lower units must first install Release 8.1(65) (or higher 8.1) or any Release 9.0 and then upgrade to Release 9.1 or higher. Care should be taken to ensure that no calls are made before the final upgrade, otherwise the system will require upgrade license.

## 12.18 TAA

Those items labeled as TAA are compliant with the requirements of the Trade Agreements Act which is a pre-requisite for federal purchases in the United States of America. Unless otherwise stated, the TAA variants of equipment are physically and functionally the same as the non-TAA variants.

		SAP Code
<b>Control Unit</b>	<a href="#">IPO IP500 V2 CNTRL UNIT TAA</a> <sup>[190]</sup>	700501510
<b>Base Cards</b>	<a href="#">IPO IP500 EXTN CARD DGTL STA 8 TAA</a> <sup>[200]</sup>	700501512
	<a href="#">IPO IP500 V2 COMB CARD ATM TAA</a> <sup>[200]</sup>	700501513
	<a href="#">IPO IP500 VCM 32 TAA</a> <sup>[212]</sup>	700501518
	<a href="#">IPO IP500 VCM 32 TAA V2</a> <sup>[212]</sup>	700504033
<b>Trunk Daughter Cards</b>	<a href="#">IPO IP500 TRNK BRI 4 UNI TAA</a> <sup>[217]</sup>	700501515
	<a href="#">IPO IP500 TRNK PRI UNVRSL SNGL TAA</a> <sup>[218]</sup>	700501514
	<a href="#">IPO IP500 TRNK PRI UNVRSL DUAL TAA</a> <sup>[218]</sup>	700501517
<b>External Expansion Modules</b>	<a href="#">IPO IP500 EXP MOD ANLG TRNK 16 TAA</a> <sup>[221]</sup>	700501511
	<a href="#">IPO IP500 EXP MOD DGTL STA 16 TAA</a> <sup>[220]</sup>	700501516
<b>Telephones</b>	<a href="#">9608 IP Deskphone TAA Global</a> <sup>[290]</sup>	700501428, 700507947
	<a href="#">9608G IP Deskphone TAA Global</a> <sup>[290]</sup>	700507946
	<a href="#">9611G IP Deskphone TAA Global</a> <sup>[292]</sup>	700501429, 700507948
	<a href="#">9621G IP Deskphone TAA Global</a> <sup>[290]</sup>	700500254, 700506516
	<a href="#">9641G IP Deskphone TAA Global</a> <sup>[302]</sup>	700501431, 700506519

# Chapter 13.

# Safety Statements

---

## 13. Safety Statements

The Avaya IP500 Office modules are intended to be installed by 'Service Personnel' and it is the responsibility of the Service Personnel to ensure that all subsidiary interconnected equipment is wired correctly and also meet the safety requirements of IEC60950 or UL60950 where applicable.



- The CE mark affixed to this equipment means that the module complies with the 1999/5/EC (R&TTE), 89/336/EEC (EMC) and 72/23EEC (LVD) Directives.
- The Declarations of Conformity (DoC) for the IP500 products are available on the IP Office Application DVD.
-  This warning symbol is found on the base of IP500 modules.
- Refer to [Trunk Interface Modules](#)<sup>[39†]</sup> for information concerning which Trunk Interface module variants are fitted in which country.

In Finland, Norway and Sweden a protective earthing conductor must be attached to the protective earth point on the rear of the IP500 V2 control unit. See [Grounding](#)<sup>[90†]</sup> for more information. In addition the Server must be located in a restricted access location where equipotential bonding has been applied, for example, in a telecommunication centre.

### 13.1 Lightning Protection/Hazard Symbols

#### Lightning protectors

The buildings lightning protectors must be verified as follow:

1. Check the lightning protectors, at the trunk cable entry point to the building housing the Avaya IP Office, paying special attention to the lightning protection grounding. Report any problems, in writing, to the telephone company.
2. Equipment that is designed to be connected using internal wiring is typically not lightning protected. Hence, Avaya IP Office extension cabling must not leave the building. For installations where telephones and/or other standard (tip/ring) devices are installed in another building then lightning protection is required (see [Out of Building Telephone Installations](#)<sup>[38†]</sup>).



#### Hazard Symbol

The shock hazard symbol is intended to alert personnel to electrical hazard or equipment damage. The following precautions must also be observed when installing telephone equipment:

1. Never install telephone wiring during a lightning storm.
2. Never install telephone jacks in wet locations unless the jack is specifically designed for wet locations.
3. Never touch uninsulated telephone wires or terminals unless the telephone line has been disconnected at the network interface.
4. Always use caution when working with telephone lines.

## 13.2 Trunk Interface Modules

To ensure the validation of the approvals, only the following types of trunk interface cards must be fitted in the following IP Office control units.

USA/Canada						
Product	Quad BRI	PRI E1		PRI T1		Analog Trunk Card
		Single	Dual	Single	Dual	
IP500 V2	✗	✗	✗	✓	✓	✓
IP500	✗	✗	✗	✓	✓	✓

Rest of World						
Product	Quad BRI	PRI E1/E1R2		PRI T1		Analog Trunk Card
		Single	Dual	Single	Dual	
IP500 V2	✓	✓	✓	✗	✗	✓
IP500	✓	✓	✓	✗	✗	✓

### Notes

- E1R2 trunks are only supported in CALA and Korea.

## 13.3 Further Information and Product Updates

Further information, including Product and Reference Manual updates, can be obtained from Avaya Dealers and Distributors or from Avaya's web site: <http://www.avaya.com>.

This guide is also available from the Avaya's support web site: <http://support.avaya.com>.

### Support Telephone Numbers

For initial help and support, contact your distributor/supplier. The following contact points are for Avaya authorized partners.

- In the USA only  
Avaya provides a toll-tree Customer Helpline 24 hours a day:
  - Name: Avaya Technical Support Organization (TSO)
  - Customer Helpline: 1 800 628-2888
  - Address: 8744 Lucent Blvd., Highlands Ranch, Colorado, 80129 USA
  - URL: <http://support.avaya.com>  
If you need assistance when installing, programming, or using your system, call the Helpline or your Avaya representative. Consultation charges may apply.
- Outside the USA  
If you need assistance when installing, programming, or using your system, contact your Avaya representative.
  - URL: <http://support.avaya.com>

## 13.4 Port Safety Classification

The Avaya IP Office systems have the following ports which are classified as follows:

Port Name	Port Description	Port Classification
<b>PRI port</b>	PRI ISDN connection (NET)	TNV (Operating within the limits of SELV)
<b>BRI ports</b>	BRI ISDN connection (NET)	TNV (Operating within the limits of SELV)
<b>Analog ports</b>	Two wire analog trunk	TNV3
<b>Power fail ports</b>	Two wire analog trunk	TNV3
<b>RS232 DTE port</b>	Async Data connection.	SELV
<b>Analog Telephone Ports</b>	Telephone Extension ports	TNV2
<b>Digital Telephone Ports</b>	Telephone Extension ports	SELV
<b>LAN ports</b>	10/100 BaseT attachment to LAN.	SELV
<b>Expansion ports</b>	Expansion Module connector.	SELV
<b>Audio port</b>	Connector for Music on Hold.	SELV
<b>External Control port</b>	Connector for Controlling Ancillary circuits.	SELV
<b>DC Input port</b>	Connector for DC input power.	SELV

Interconnection circuits shall be selected to provide continued conformance with the requirements of EN 609050:1992/A3:1995 clause 2.3 for SELV circuits and with the requirements of clause 6 for TNV circuits, after connections between equipment.



## 13.5 EMC Directive

889/336/ EEC (EMC Directive) CISPR 22:1993 including A1 + A2, AS/NZ 3548:1995 (ROW)

-  **WARNING**

This is a class A product. In a domestic environment this product may cause radio interference in which case the user may be required to take adequate measures.

### Federal Communications Commission (FCC)

This equipment has been tested and found to comply with the limits for a Class A digital device, pursuant to Part 15 of the FCC Rules. These limits are designed to provide reasonable protection against harmful interference when the equipment is operated in a commercial environment. This equipment generates, uses, and can radiate radio frequency energy and, if not installed and used in accordance with the instruction manual, may cause harmful interference to radio communications. Operation of this equipment in a residential area is likely to cause harmful interference, in which case the user will be required to correct the interference at his or her own expense.

### Canadian Department of Communications (DOC)

"NOTICE: This equipment meets the applicable Industry Canada Terminal Equipment Technical Specifications. This is confirmed by the registration number. The abbreviation, IC, before the registration number signifies that registration was performed based on a Declaration of Conformity indicating that Industry Canada technical specifications were met. It does not imply that Industry Canada approved the equipment."

### EMC Caution for China

## 警示

注意：此为A级产品，在生活环境中，该产品可能会造成无线电干扰。在这种情况下，可能需要用户对其干扰采取切实可行的措施。仅适用于商业或工业环境。

---

## 13.6 Regulatory Instructions for Use

### 13.6.1 Australia

#### Connection

Connection of IP Office products must be via a Line Isolation Module with a telecommunications compliance label.

#### **BRI Interface**

During the configuration, ensure "000" emergency number is not barred, by performing the following:

- Short Code: 000
- Telephone No: 000;
- Function: DialEmergency

Connections to TS013, the following Bearer Capabilities shall not be used:

- 7kHz Audio, Video, Restricted Digital Information.

If unknown type of number is used in calling party number, the network will use the default CLI.

The system must be configured for Point to Multi point connection to comply with Austel requirements for connecting to TS013 circuits.

As the IP Office does not support emergency dialing after loss of power, the following warning notice should be recognized:

- **WARNING**  
This equipment will be inoperable when mains power fails.

#### PRI Interface

During the configuration, ensure "000" emergency number is not barred, by performing the following:

- Short Code: 000
- Telephone No: 000;
- Function: DialEmergency

- **WARNING**  
This equipment will be inoperable during mains power failure.

### 13.6.2 Canada

This equipment meets the applicable Industry Canada Terminal Equipment Technical Specifications. This is confirmed by the registration number. The abbreviation, IC, before the registration number signifies that registration was performed based on a Declaration of Conformity indicating that Industry Canada technical specifications were met.

It does not imply that Industry Canada approved the equipment.

"NOTICE: The Ringer Equivalence Number (REN) for this terminal equipment is 1. The REN assigned to each terminal equipment provides an indication of the maximum number of terminals allowed to be connected to a telephone interface. The termination on an interface may consist of any combination of devices subject only to the requirement that the sum of the Ringer Equivalence Numbers of all the devices does not exceed five."

## 13.6.3 China



700433220

February 2007

Copyright© 2007, Avaya Inc. All Rights Reserved

**所有在中华人民共和国境内进口或销售的电子信息产品必须附上本文件**  
**Include this document with all Electronic Information Products imported or sold in the People's Republic of China**

部件名称 (Part Name)	有毒有害物质或元素 (Hazardous Substance)					
	铅 (Pb)	汞 (Hg)	镉 (Cd)	六价铬 (Cr <sup>6+</sup> )	多溴联苯 (PBB)	多溴二苯醚 (PBDE)
金属部件 (Metal Parts)	×	○	○	○	○	○
电路模块 (Circuit Modules)	×	○	○	○	○	○
电缆及电缆组件 (Cables & Cable Assemblies)	×	○	○	○	○	○
塑料和聚合物部件 (Plastic and Polymeric parts)	○	○	○	○	○	○
电路开关/断路器 (Circuit Switch/Breakers)	○	○	○	○	○	○
电源组件 (Power Assemblies)	×	○	○	○	○	○
显示器 (LCD, Monitor)	○	○	○	○	○	○
玻璃 (Glass)	○	○	○	○	○	○

○：表示该有毒有害物质在该部件所有均质材料中的含量均在 SJ/T 11363 2006 标准规定的限量要求以下。  
Indicates that the concentration of the hazardous substance in all homogeneous materials in the parts is below the relevant threshold of the SJ/T 11363 2006 standard.

×：表示该有毒有害物质至少在该部件的某一均质材料中的含量超出 SJ/T 11363 2006 标准规定的限量要求。  
Indicates that the concentration of the hazardous substance of at least one of all homogeneous materials in the parts is above the relevant threshold of the SJ/T 11363 2006 standard.

本表显示，所附的亚美亚电子信息产品中，从生产日期起，可能包含这些物质。注意：所附产品可能包含或不包含以上所列的某些组件。

This table shows where these substances may be found in Avaya's electronic information products, as of the date of manufacture of the enclosed product. Note that some of the component types listed above may or may not be a part of the enclosed product.

除非有另外特别的标注,此标志将作为所附产品及零部件的环保使用期标志. 某些产品会有一个不同的环保使用期(例如,电话机)并贴在其产品上.此环保使用期限只适用于产品在产品手册中所规定的条件下使用



The Environmentally Friendly Use Period (EFUP) for all enclosed products and their parts are per the symbol shown here, unless otherwise marked. Certain products have a different EFUP (for example, telephones) and so are marked to reflect such. The Environmentally Friendly Use Period is valid only when the product is operated under the conditions defined in the product manual.

## 13.6.4 Japan

The power cord set included in the shipment or associated with the product is meant to be used with the said product only. Do not use the cord set for any other purpose. Any non-recommended usage could lead to hazardous incidents like fire disaster, electric shock, and faulty operation.

本製品に同梱または付属している電源コードセットは、本製品専用です。本製品以外の製品ならびに他の用途で使用しないでください。火災、感電、故障の原因となります

### If this is a Class A device:

This is a Class A product based on the standard of the Voluntary Control Council for Interference by Information Technology Equipment (VCCI). If this equipment is used in a domestic environment, radio disturbance may occur, in which case, the user may be required to take corrective actions.

この装置は、情報処理装置等電波障害自主規制協議会（VCCI）の基準に基づいてクラスA情報技術装置です。この装置を家庭環境で使用すると電波妨害を引き起こすことがあります。この場合には使用者が適切な対策を講ずるよう要求されることがあります

### If this is a Class B device:

This is a Class B product based on the standard of the Voluntary Control Council for Interference from Information Technology Equipment (VCCI). If this is used near a radio or television receiver in a domestic environment, it may cause radio interference. Install and use the equipment according to the instruction manual.

この装置は、情報処理装置等電波障害自主規制協議会（VCCI）の基準に基づいてクラスB情報技術装置です。この装置は、家庭環境で使用することを目的としていますが、この装置がラジオやテレビジョン受信機に近接して使用されると、受信障害を引き起こすことがあります。取扱説明書に従って正しい取り扱いをして下さい

## 13.6.5 European Union

1. 999 and 112 calls must not be barred. Doing so will invalidate the approval.
2. All connections at the MDF shall be identifiable by suitable labeling.
3. The CE mark displayed on IP Office equipment indicates the systems compliance with the EMC, LVD, and R&TTE Directives and common technical regulations for Primary Rate and Basic Rate ISDN.
4. All ports for the connection of other non-telecommunications apparatus have a Safety Extra Low Voltage (SELV) safety status.



### European Union Declarations of Conformity

Avaya Inc. declares that the equipment specified in this document bearing the "CE" (Conformité Européenne) mark conforms to the European Union Radio and Telecommunications Terminal Equipment Directive (1999/5/EC), including the Electromagnetic Compatibility Directive (2004/108/EC) and Low Voltage Directive (2006/95/EC).

Copies of these Declarations of Conformity (DoCs) can be obtained by contacting your local sales representative and are available on the following Web site: <http://support.avaya.com/DoC>.



### European Union Battery Directive

Avaya Inc. supports European Union Battery Directive 2006/66/EC. Certain Avaya Inc. products contain lithium batteries. These batteries are not customer or field replaceable parts. Do not disassemble. Batteries may pose a hazard if mishandled.

### **13.6.6 New Zealand**

The grant of a Telepermit for any item of terminal equipment indicates only that Telecom has accepted that the item complies with minimum conditions for connection to its network. It indicates no endorsement of the product by Telecom, nor does it provide any sort of warranty. Above all, it provides no assurance that any item will work correctly in all respects with another item of Telepermitted equipment of a different make or model, nor does it imply that any product is compatible with all of Telecom's network services.

### 13.6.7 FCC Notification

This equipment complies with Part 68 of the FCC rules and the requirements adopted by the Administrative Council on Terminal Attachments (ACTA). On the rear of this equipment is a label that contains, among other information, a product identifier in the format US:AAAEQ##TXXX. If requested, this number must be provided to the telephone company.

The REN is used to determine the quantity of devices that may be connected to the telephone line. Excessive RENs on the telephone line may result in devices not ringing in response to an incoming call. In most, but not all areas, the sum of RENs should not exceed 5.0. To be certain of the number of devices that may be connected to a line, as determined by the total RENs, contact the local telephone company. For products approved after July 23, 2001, the REN for this product is part of the product identifier that has the format US:AAAEQ##TXXX. The digits represented by ## are the REN without a decimal point (for example, 03 is a REN of 0.3). For earlier products, the REN is separately shown on the label.

### Means of Connection

Connection of this equipment to the telephone network is shown in the following table.

Port	FIC	SOC	USOC Jack	REN
IP500 PRI 1U, IP500 PRI2U	04DU9.BN, 04DU9.DN, 04DU9.IKN, 04DU9.ISN	6.0Y	RJ48C	NA
IP500 ATM4U	OL13A, OL13B, OL13C, 02AC2, 02LA2, 02LB2, 02LC2, 02LR2, 02LS2	9.0Y	RJ45S	0.1B
IP500 ATM16	OL13A, OL13B, OL13C, 02AC2, 02GS2, 02LA2, 02LB2, 02LC2, 02LR2, 02LF2 02GS2, 02LS2	9.0Y	RJ45S	0.1B

If this equipment causes harm to the telephone network, the telephone company will notify you in advance that temporary discontinuance of service may be required. But if advance notice is not practical, the telephone company will notify the customer as soon as possible. Also, you will be advised of your right to file a complaint with the FCC if you believe it is necessary.

The telephone company may make changes in its facilities, equipment, operations or procedures that could affect the operation of the equipment. If this happens, the telephone company will provide advance notice in order for you to make necessary modifications to maintain uninterrupted service.

If trouble is experienced with this equipment, for repair or warranty information, please contact the Technical Service Center at 1-800-242- 2121 or contact your local Avaya representative. If the equipment is causing harm to the telephone network, the telephone company may request that you disconnect the equipment until the problem is resolved.

A plug and jack used to connect this equipment to the premises wiring and telephone network must comply with the applicable FCC Part 68 rules and requirements adopted by the ACTA.

Connection to party line service is subject to state tariffs. Contact the state public utility commission, public service commission or corporation commission for information.

### **Equipment With Direct Inward Dialing (“DID”):**

Allowing this equipment to be operated in such a manner as to not provide proper answer supervision is a violation of Part 68 of the FCC’s rules.

Proper Answer Supervision is when:

A. This equipment returns answer supervision to the public switched telephone network (PSTN) when DID calls are:

- answered by the called station,
- answered by the attendant,
- routed to a recorded announcement that can be administered by the customer premises equipment (CPE) user.
- Routed to a dial prompt

B. This equipment returns answer supervision signals on all (DID) calls forwarded back to the PSTN.

Permissible exceptions are:

- A call is unanswered.
- A busy tone is received.
- A reorder tone is received.

Avaya attests that this registered equipment is capable of providing users access to interstate providers of operator services through the use of access codes. Modification of this equipment by call aggregators to block access dialing codes is a violation of the Telephone Operator Consumers Act of 1990.

### **Automatic Dialers:**

When programming emergency numbers and (or) making test calls to emergency numbers:

1. Remain on the line and briefly explain to the dispatcher the reason for the call.
2. Perform such activities in the off-peak hours, such as early morning or late evenings.

### **Toll Restriction and Least Cost Routing Equipment:**

The software contained in this equipment to allow user access to the network must be upgraded to recognize newly established network area codes and exchange codes as they are placed into service.

Failure to upgrade the premises systems or peripheral equipment to recognize the new codes as they are established will restrict the customer and the customer’s employees from gaining access to the network and to these codes.

### **FCC Part 68 Supplier’s Declarations of Conformity**

Avaya Inc. in the United States of America hereby certifies that the equipment described in this document and bearing a TIA TSB-168 label identification number complies with the FCC’s Rules and Regulations 47 CFR Part 68, and the Administrative Council on Terminal Attachments (ACTA) adopted technical criteria.

Avaya further asserts that Avaya handset-equipped terminal equipment described in this document complies with Paragraph 68.316 of the FCC Rules and Regulations defining Hearing Aid Compatibility and is deemed compatible with hearing aids.

---

## 13.6.8 Compliance with FCC Rules

### Transmit and Receive Gain Settings for PRI/T1 and Analog Ports

The Gain settings are password controlled for use by qualified installation personnel only and must not be made available to the end user. The default gain settings of 0dB ensures compliance with FCC part 68 section 68.308(b)(5) and TIA/EIA-IS-968 Section 4.5.2.5. "Through transmission amplification from ports for the connection of separately registered equipment or from other network connection ports". Gain setting adjustment by unqualified personnel may result in violation of the FCC rules. Qualified personnel may adjust gain settings above these levels only where:

1. Measurement is made to ensure that the power levels sent to line at each network interface connected does not exceed the maximum levels specified in FCC part 68 section 68.308(b) and TIA/EIA-IS-968 Section 4.5 for that specific interface type.
2. Where gain adjustment away from the default values are made, precautions should be taken to ensure that the connection of terminal equipment is controlled by qualified installation personnel.
3. To conform with the Receive Objective Loudness Rating at distances greater than 2.7km from the central office, on analog trunks a receive gain of 1.5dB must be set.



# Chapter 14.

## Document History

## 14. Document History

Date	Issue	Change Summary
31st October 2014	30b	<ul style="list-style-type: none"> <li>Updated for IP Office Release 9.1.</li> </ul>
13th November 2014	30c	<ul style="list-style-type: none"> <li>Updated default password change screen.</li> </ul>
26th November 2014	30d	<ul style="list-style-type: none"> <li>First external published version.</li> </ul>
7th January 2015	30e	<ul style="list-style-type: none"> <li>Reinstated the control units section of the <a href="#">Hardware/Software Compatibility</a><sup>[386]</sup> section.</li> </ul>
16th January 2015	30f	<ul style="list-style-type: none"> <li>Incorrect MT700, etc references corrected.</li> </ul>
27th January 2015	30g	<ul style="list-style-type: none"> <li>Update to hardware compatibility to clarify DS16B/30B support in 8.0/8.1 service packs.</li> </ul>
10th April 2015	30h	<ul style="list-style-type: none"> <li>Minor correct to BRI combo card description (repeated sentence removed).</li> <li>Part number details for Japanese Dual PRI card added.</li> <li>Statement that ContactStore not supported on virtual server added.</li> </ul>
16th April 2015	30i	<ul style="list-style-type: none"> <li>Corrected appearance of old name for Avaya Communicator.</li> </ul>
18th May 2015	30j	<ul style="list-style-type: none"> <li>Update that 96X1 series phones also support SBM24 button modules. [83673] [83673]</li> </ul>
29th July 2015	30k	<ul style="list-style-type: none"> <li>Correction. Planned support for DS16B/DS30B was not implemented for 8.0. [81164]</li> </ul>
12th August 2015	30l	<ul style="list-style-type: none"> <li>Clarification of addition power supply requirement necessary for DBM32 module with 1416 telephone.</li> </ul>
20th August 2015	30m	<ul style="list-style-type: none"> <li>Clarification on 1616 button module support.</li> </ul>
8th September 2015	30n	<ul style="list-style-type: none"> <li>Minor text layout changes for BM32 topic.</li> <li>Correction of <a href="#">SD card SAP codes</a><sup>[196]</sup>.</li> </ul>
8th September 2015	30o	<ul style="list-style-type: none"> <li>Update that 9.1 IP Office Manager <a href="#">backwards compatible</a><sup>[34]</sup> is now only supported to IP Office Release 6.0.</li> </ul>
8th October 2015	30p	<ul style="list-style-type: none"> <li>Clarification of that Combo card trunk cards cannot be changed or swapped.</li> </ul>
16th October 2015	30q	<ul style="list-style-type: none"> <li>Tidying up of the flow of installation topics.</li> </ul>
21st October 2015	30r	<ul style="list-style-type: none"> <li>Replace ITW Linx towerMAX SCL/8 references with ITW Linx MDS2.</li> </ul>
22nd October 2015	30s	<ul style="list-style-type: none"> <li>Clarification that Phone Manager Pro legacy licenses allow Office Worker but without Communicator. [102107]</li> </ul>
6th November 2015	30u	<ul style="list-style-type: none"> <li>Updates to 9600 Series phone order codes.</li> </ul>
21st December 2015	30v	<ul style="list-style-type: none"> <li>Clarification to Web Collaboration licensing.</li> </ul>
12th January 2016	30w	<ul style="list-style-type: none"> <li>Removed statements implying virtual server support for ContactStore.</li> </ul>
25th January 2016	30x	<ul style="list-style-type: none"> <li>Link between Manager installation section and supported Windows versions section.</li> </ul>
26th January 2016	30y	<ul style="list-style-type: none"> <li>Clarification of Manager versions.</li> </ul>

# Index

## A

### Add-Ons

- 201B Recorder 326
- 4450 Features 327
- EU24 Features 330
- EU24BL Features 331
- Programmable Buttons 327, 330, 331, 334, 336
- T3 DSS Features 334
- XM24 Features 336

### Analog

- Phone Barrier Boxes 174
- Phone Region Availability 39, 242
- Port 353, 356

### Application

- Call Center 47
- Call Logging 47
- CD/DVD 44
- ContactStore 340
- CTI 47
- Maintenance 45
- Manager 341
- Monitor 341
- SoftConsole 344
- System Status Application 346
- TAPI 347
- User 46
- Voicemail 46
- VoiceMail Pro 348

### Assessments

- Network 41
- VoIP 41

### Audio

- Codec Conversion 42
- Port 353

### Audio Port 356

## B

### Backup

- SD Card 129

### Barrier Boxes

- Analog Phone 174
- Rack Mounting 175

### Base Card

- Analog Phone 21, 198
- Digital Station 21, 198
- Legacy Card Carrier 21, 198
- VCM 21, 198

### BRI

- (So) Port 357
- (Trunk) Port 358
- Port 353

## C

### Cable

- Access Requirements 54
- Clearance Requirements 54

### Cables

- Maximum Cable Distances 33, 354
- Standard IP Office 33, 354

### Cabling

- Lightening Protection 36, 172

### Call Logging Application 47

### Call Status

- Application 45

### Cards

IP500 Analog Phone Base 202

IP500 Digital Station Base 208

IP500 VCM 212

Castle Rock 180

### Channels

Compression 42

Clock 108

### Compact Business Center

Application 47

### Compact Contact Center

Application 47

### Compression Channels 42

### Conference Center

Application 46

### Configuration

Create New 76

Erase 154

### Connections

Grounding 35

Out of Building 36, 172

### ContactStore

Application 46

Components 340

License Requirements 340

PC Requirements 340

### Control Unit

IP406 V2 18

IP412 18

IP500 System Unit 18

Rack Mounting 37

SOE 18

Wall Mounting 37

### Copy

SD Card 133, 134

### Country

Languages 43

Supported Locales 43

### Create Configuration 76

## D

### Daughter Cards

Analog Trunk 24, 215

BRI Trunk 24, 217

PRI Trunk 218

PRI-U Trunk 24

Trunk 24

### DC I/P

Port 353

### DCI I/P Port 360

### DECT

Handset 263, 264

Phone 39, 242

Region Availability 39, 242

### DevLink Application 47

### DS

IROB 173

Phone 39, 173, 242

Port 353, 360

Region Availability 39, 242

### DTE Port 185

Cable requirement 367

RS232 367

Settings 367

## E

### Embedded Voicemail

Application 46

---

EMC Cautions  
 Canadian Department of Communications 393  
 EMC Caution for China 393  
 Federal Communications Commission 393

Envirmental Requirements 53

Expansion  
 Port 353

Expansion Modules  
 IP400 Analog Trunk 16 235  
 IP400 Digital Station V2 237  
 IP400 Phone V2 239  
 IP500 Analog Trunk 16 221  
 IP500 BRI So8 223  
 IP500 Digital Station 25, 225  
 IP500 Phone 25, 232  
 IPO 500 Analog Trunk 25  
 IPO 500 BRI So8 25

Expansion Port 362

EXT O/P  
 Port 353

EXT O/P Port 176, 362

Extension Numbers  
 Swapping 171

External Expansion Modules 25

**F**

Faulty Units 12

FCC Rules 400

Feature Key Server  
 Application 45

Feature Keys  
 Parallel 38  
 Serial 38  
 Smart Card 38  
 USB 38

Features  
 2402D Phone 255  
 2410D Phone 256  
 2420 Phone 257  
 3616 Phone 258  
 3620 Phone 259  
 3626 Phone 260  
 3641 Phone 261, 263  
 3645 Phone 262  
 3711 Phone 264  
 3810 Phone 269  
 4406D+ Phone 271  
 4412D+ Phone 272  
 4424D+ Phone 273  
 4601 Phone 274  
 4602IP Phone 275  
 4602SW Phone 275  
 4610SW Phone 276  
 4620IP Phone 277  
 4620SW Phone 277  
 4621SW Phone 278  
 4625SW Phone 279  
 5202D Phone 280  
 5220D Phone 282  
 5410 Phone 281  
 5601 Phone 283  
 5602IP Phone 284  
 5602SW Phone 284  
 5610SW Phone 285  
 5620 Phone 286  
 5621 Phone 287  
 T3 Classic 322  
 T3 Comfort 323  
 T3 Compact 324

Firewall Exceptiong 348

**G**

General Information  
 Training Courses 48  
 Web Sites 48

Grounding Control Units 35

**H**

H323  
 Phones 39, 242  
 Region Availability 39, 242

Hazard Symbols 390

Hazardous Substances 12

Homologation Statement 390

HP OpenView 180

**I**

IP Office Operation in  
 Australia 394  
 Canada 394  
 China 395  
 European Union 396  
 New Zealand 397  
 USA 398

IP500  
 Analog Phone Base Card 21, 198  
 Analog Trunk Daughter Card 24  
 BRI Trunk Daughter Card 24  
 Digital Station Base Card 21, 198  
 Legacy Card Carrier Base Card 21, 198  
 PRI-U Trunk Daughter Card 24  
 Reset Button 184  
 Trunk Daughter Card 24  
 VCM Base Card 21, 198

IP500 Installation  
 Admin Applications 66  
 Card 80  
 Check Card LED 93  
 Connect Manager 68  
 Documentation 60  
 Grounding 90  
 Rack Mounting 87  
 Start Manager 69  
 Tools 59  
 Unpacking 61

**L**

LAN  
 Port 353

LAN Port 363

Licences  
 ContactStore 340  
 Manager 341  
 Monitor 341  
 SoftConsole 344  
 Syatem Status Application 346  
 TAPI 347  
 VoiceMail Pro 348

Licenses  
 PC-Base 38  
 PC-Less 38

Lightening Portection 390

Lightening Protection 36, 172

**M**

Maintenance

- Maintenance
  - Applications 45
- Manager
  - Application 45
  - Clock Quality 108
  - Components 341
  - License Requirements 341
  - PC Requirements 341
  - Prefix Dialing 110
  - Trunks 106
  - Upgrade Software 164
- Memory card
  - Removal 122
- Module
  - Polycom Video 178
- Modules
  - Trunk Interface 391
- Monitor
  - Application 45
  - Components 341
  - License Requirements 341
  - PC Requirements 341
  - Protocols 348
- MS-CRM
  - Application 46
- N**
- Network Assessments 41
- New Configuration 76
- O**
- Out of Building
  - Connections 36, 172
- P**
- Parallel Feature Key 38
- PC-Base Licensing 38
- PC-Less Licensing 38
- PF
  - Port 353
- PF Port 364
- Phone (POT)
  - Port 353
- Phone (POT) Port 365
- Phone 2000 Series
  - 2402D 255
  - 2410D 256
  - 2420 257
- Phone 3000 Series
  - 3616 258
  - 3620 259
  - 3626 260
  - 3641 261
  - 3645 262
  - 3701 263
  - 3711 264
  - 3810 269
  - DECT Handset 263, 264
  - WiFi 258, 259, 260, 261, 262
  - Wireless 269
- Phone 4000 Series
  - 4406D+ 271
  - 4412D+ 272
  - 4424D+ 273
  - 4601 274
  - 4602IP 275
  - 4602SW 275
  - 4610SW 276
  - 4620 277
  - 4620SW 277
  - 4621SW 278
  - 4625SW 279
- Phone 5000 Series
  - 5402D 280
  - 5410 281
  - 5420D 282
  - 5601 283
  - 5602IP 284
  - 5602SW 284
  - 5610SW 285
  - 5620 286
  - 5621 287
- Phone T3 Series
  - Classic 322
  - Comfort 323
  - Compact 324
- Polycom Video Module 178
- Port
  - Analog 353, 356
  - Assigned 348
  - Audio 353, 356
  - BRI 353
  - BRI (So) 357
  - BRI (Trunk) 358
  - DC I/P 353
  - DCI I/P 360
  - Door 176
  - DS 353, 360
  - Expansion 353, 362
  - EXT O/P 176, 353, 362
  - IP Office 348
  - LAN 353, 363
  - PF 353, 364
  - Phone (POT) 353, 365
  - PRI 353, 366
  - RS232/DTE 353
  - RS323 DTE 367
  - Safety Classification 392
  - USB 353
  - Used 348
  - WAN 353
- Power Supplies
  - 1151C1 30
  - 1151C2 30
  - Cords 31
  - Type 40w PSU 30
  - Type 45W Earthed PSU 30
  - Type 60W Earthed PSU 30
  - Uninterrupted Power Supply 32
- PRI
  - Port 353
- PRI Port 366
- Programmable Buttons 327, 330, 331, 334, 336
- Protocols 348
- R**
- Rack Mounting Control Units 37
- Recorder Interface 326
- Region Availability
  - Analog Phone 39, 242
  - DECT Phone 39, 242
  - DS Phone 39, 242
  - H323 Phone 39, 242
- Remove
  - SD Card 122

Requirements	
Cable Access	54
Cable Clearance	54
Environmental	53
Space	54
Wall Mounting	53
Restore	
SD Card	130
RoHS	12
RS232/DTE	
Port	353
<b>S</b>	
Safety Statement	390
SAP Codes	
201B Recorder	326
2402D Phone	255
2410D Phone	256
2420D Phone	257
3616 Phone	258
3620 Phone	259
3626 Phone	260
3641 Phone	263
3711 Phone	264
3810 Phone	269
4406D+ Phone	271
4412D+ Phone	272
4424D+ Phone	273
4450 Programmable Buttons	327
4601 Phone	274
4602IP Phone	275
4602SW Phone	275
4610SW Phone	276
4620IP Phone	277
4620SW Phone	277
4621SW Phone	278
4625SW Phone	279
5402D Phone	280
5410 Phone	281
5420D Phone	282
5601 Phone	283
5602IP Phone	284
5602SW Phone	284
5610SW Phone	285
5620 Phone	286
5621 Phone	287
EU24 Programmable Buttons	330
EU24BL Programmable Buttons	331
T3 Classic	322
T3 Comfort	323
T3 Compact	324
T3 DSS Programmable Buttons	334
XM24 Programmable Buttons	336
SD Card	
Backup	129
Copy	133, 134
Removal	122
Restore	130
Security Settings	
Default	157
Serial Feature Key	38
Smart card Feature Key	38
SNMP	180
Enabling	183
Installation	181
Port	183
respond	183
Trap Sending	183
SNMP MIBs	
Application	45
So8	
Example ISDN Terminal	177
Example Video Conference	178
SoftConsole	
Application	46
Components	344
License Requirements	344
PC Requirements	344
Software	
Erase Core Software	186
Space Requirements	54
Statement	
Homologation	390
Safety	390
Supported	
Language	43
Locales	43
System Status	
Application	45
System Status Application	
Components	346
License Requirements	346
PC Requirements	346
<b>T</b>	
TAPI	
Components	347
License Requirements	347
PC Requirements	347
WAV Driver Application	47
TAPILink Lite	
Application	46
TAPILink Pro Application	47
Training Courses	48
Trunk Interface Modules	391
<b>U</b>	
USB	
Feature Key	38
Port	353
<b>V</b>	
Voice Compression Channels	42
VoiceMail Lite	
Application	46
VoiceMail Pro	
Application	46
Components	348
License Requirements	348
PC Requirements	348
VoIP Assessments	41
<b>W</b>	
Wall Mounting Control Units	37
Wall Mounting Requirements	53
WAN	
Port	353
Waterproof Phone	259
Web Sites	48
WiFi Phone	258, 259, 260, 261, 262
Wireless Phone	269



