



IP Office 7.0

**IP Office Essential Edition - Quick
Version Installation**

Notices

While reasonable efforts have been made to ensure that the information in this document is complete and accurate at the time of printing, Avaya assumes no liability for any errors. Avaya reserves the right to make changes and corrections to the information in this document without the obligation to notify any person or organization of such changes.

Documentation disclaimer

Avaya shall not be responsible for any modifications, additions, or deletions to the original published version of this documentation unless such modifications, additions, or deletions were performed by Avaya.

End User agree to indemnify and hold harmless Avaya, Avaya's agents, servants and employees against all claims, lawsuits, demands and judgments arising out of, or in connection with, subsequent modifications, additions or deletions to this documentation, to the extent made by End User.

Link disclaimer

Avaya is not responsible for the contents or reliability of any linked Web sites referenced within this site or documentation(s) provided by Avaya. Avaya is not responsible for the accuracy of any information, statement or content provided on these sites and does not necessarily endorse the products, services, or information described or offered within them. Avaya does not guarantee that these links will work all the time and has no control over the availability of the linked pages.

Warranty

Avaya provides a limited warranty on this product. Refer to your sales agreement to establish the terms of the limited warranty. In addition, Avaya's standard warranty language, as well as information regarding support for this product, while under warranty, is available to Avaya customers and other parties through the Avaya Support Web site: <http://www.avaya.com/support>. Please note that if you acquired the product from an authorized Avaya reseller outside of the United States and Canada, the warranty is provided to you by said Avaya reseller and not by Avaya.

Licenses

THE SOFTWARE LICENSE TERMS AVAILABLE ON THE AVAYA WEBSITE, [HTTP://SUPPORT.AVAYA.COM/LICENSEINFO/](http://support.avaya.com/licenseinfo/) ARE APPLICABLE TO ANYONE WHO DOWNLOADS, USES AND/OR INSTALLS AVAYA SOFTWARE, PURCHASED FROM AVAYA INC., ANY AVAYA AFFILIATE, OR AN AUTHORIZED AVAYA RESELLER (AS APPLICABLE) UNDER A COMMERCIAL AGREEMENT WITH AVAYA OR AN AUTHORIZED AVAYA RESELLER. UNLESS OTHERWISE AGREED TO BY AVAYA IN WRITING, AVAYA DOES NOT EXTEND THIS LICENSE IF THE SOFTWARE WAS OBTAINED FROM ANYONE OTHER THAN AVAYA, AN AVAYA AFFILIATE OR AN AVAYA AUTHORIZED RESELLER, AND AVAYA RESERVES THE RIGHT TO TAKE LEGAL ACTION AGAINST YOU AND ANYONE ELSE USING OR SELLING THE SOFTWARE WITHOUT A LICENSE. BY INSTALLING, DOWNLOADING OR USING THE SOFTWARE, OR AUTHORIZING OTHERS TO DO SO, YOU, ON BEHALF OF YOURSELF AND THE ENTITY FOR WHOM YOU ARE INSTALLING, DOWNLOADING OR USING THE SOFTWARE (HEREINAFTER REFERRED TO INTERCHANGEABLY AS "YOU" AND "END USER"), AGREE TO THESE TERMS AND CONDITIONS AND CREATE A BINDING CONTRACT BETWEEN YOU AND AVAYA INC. OR THE APPLICABLE AVAYA AFFILIATE ("AVAYA").

Avaya grants End User a license within the scope of the license types described below. The applicable number of licenses and units of capacity for which the license is granted will be one (1), unless a different number of licenses or units of capacity is specified in the Documentation or other materials available to End User. "Designated Processor" means a single stand-alone computing device. "Server" means a Designated Processor that hosts a software application to be accessed by multiple users. "Software" means the computer programs in object code, originally licensed by Avaya and ultimately utilized by End User, whether as stand-alone products or pre-installed on Hardware. "Hardware" means the standard hardware originally sold by Avaya and ultimately utilized by End User.

License types

Designated System(s) License (DS). End User may install and use each copy of the Software on only one Designated Processor, unless a different number of Designated Processors is indicated in the Documentation or other materials available to End User. Avaya may require the Designated Processor(s) to be identified by type, serial number, feature key, location or other specific designation, or to be provided by End User to Avaya through electronic means established by Avaya specifically for this purpose.

Copyright

Except where expressly stated otherwise, no use should be made of materials on this site, the Documentation(s) and Product(s) provided by Avaya. All content on this site, the documentation(s) and the product(s) provided by Avaya including the selection, arrangement and design of the content is owned either by Avaya or its licensors and is protected by copyright and other intellectual property laws including the sui generis rights relating to the protection of databases. You may not modify, copy, reproduce, republish, upload, post, transmit or distribute in any way any content, in whole or in part, including any code and software. Unauthorized reproduction, transmission, dissemination, storage, and or use without the express written consent of Avaya can be a criminal, as well as a civil, offense under the applicable law.

Third Party Components

Certain software programs or portions thereof included in the Product may contain software distributed under third party agreements ("Third Party Components"), which may contain terms that expand or limit rights to use certain portions of the Product ("Third Party Terms"). Information regarding distributed Linux OS source code (for those Products that have distributed the Linux OS source code), and identifying the copyright holders of the Third Party Components and the Third Party Terms that apply to them is available on the Avaya Support Web site: <http://support.avaya.com/Copyright>.

Preventing toll fraud

"Toll fraud" is the unauthorized use of your telecommunications system by an unauthorized party (for example, a person who is not a corporate employee, agent, subcontractor, or is not working on your company's behalf). Be aware that there can be a risk of toll fraud associated with your system and that, if toll fraud occurs, it can result in substantial additional charges for your telecommunications services.

Avaya fraud intervention

If you suspect that you are being victimized by toll fraud and you need technical assistance or support, call Technical Service Center Toll Fraud Intervention Hotline at +1-800-643-2353 for the United States and Canada. For additional support telephone numbers, see the Avaya Support Web site: <http://support.avaya.com>. Suspected security vulnerabilities with Avaya products should be reported to Avaya by sending mail to: securityalerts@avaya.com.

Trademarks

Avaya and Aura are trademarks of Avaya, Inc. The trademarks, logos and service marks ("Marks") displayed in this site, the documentation(s) and product(s) provided by Avaya are the registered or unregistered Marks of Avaya, its affiliates, or other third parties. Users are not permitted to use such Marks without prior written consent from Avaya or such third party which may own the Mark. Nothing contained in this site, the documentation(s) and product(s) should be construed as granting, by implication, estoppel, or otherwise, any license or right in and to the Marks without the express written permission of Avaya or the applicable third party. Avaya is a registered trademark of Avaya Inc. All non-Avaya trademarks are the property of their respective owners.

Downloading documents

For the most current versions of documentation, see the Avaya Support Web site: <http://www.avaya.com/support>

Contact Avaya Support

Avaya provides a telephone number for you to use to report problems or to ask questions about your product. The support telephone number is 1-800-242-2121 in the United States. For additional support telephone numbers, see the Avaya Web site: <http://www.avaya.com/support>

Contents

1. System Overview

1.1 IP Office Modes.....	9
1.1.1 Hardware Support Summary.....	11
1.1.2 Feature Support Summary.....	12
1.2 IP500v2 System Components.....	13
1.3 Control Unit Cards.....	15
1.3.1 IP500 Base Cards.....	15
1.3.2 IP500 Trunk Cards.....	17
1.4 External Expansion Modules.....	18
1.4.1 IP500 External Expansion Modules.....	19
1.5 Power Supplies and Cables.....	20
1.5.1 Power Supplies.....	20
1.5.2 Power Supply Cords.....	21
1.5.3 Power Supply Backup.....	22
1.5.4 Cabling and Cables.....	23
1.5.5 Grounding.....	25
1.5.6 Lightning Protection/Out-of-Building Connections.....	26
1.6 Wall and Rack Mounting.....	27
1.7 Feature Keys and Licenses.....	29
1.8 IP Office Phones.....	30
1.9 SIP Trunks.....	31
1.10 Supported Country Locales.....	32
1.11 IP Office Software Applications.....	33
1.12 Training.....	35
1.13 Web Sites.....	35
1.14 Emergency and Power Failure Ports.....	36

2. Installation Requirements

2.1 Environmental Requirements.....	38
2.2 Space Requirements.....	39
2.2.1 IP500 and IP500v2 Control Units.....	40
2.2.2 External Expansion Modules.....	40
2.2.3 Wall Mounting.....	41
2.2.4 Rack Space Requirements.....	43

3. IP Office Administration Software

3.1 Installing the Admin Applications.....	47
3.2 Installer PC Connection.....	49
3.3 Starting Manager.....	50
3.4 Starting System Status.....	51
3.5 Starting Monitor.....	52
3.6 Phone Based Administration.....	52

4. IP500v2 Installation

4.1 Tools and Equipment Required.....	55
4.2 Documentation.....	56
4.3 Unpacking.....	57
4.4 SD Card Preparation.....	58
4.4.1 Upgrade the Card Firmware.....	58
4.4.2 Adding a Pre-Built Configuration File.....	58
4.4.3 Creating a Configuration File.....	60
4.4.4 Adding a License File.....	61
4.4.5 Adding Music on Hold Files.....	61
4.5 IP500 Card Installation.....	62
4.5.1 IP500 Daughter Card Preparation.....	63

4.5.2 IP500 Card Insertion.....	64
4.6 Wall Mounting.....	65
4.6.1 Wall Mounting Kit V2.....	66
4.6.2 Wall Mounting Kit V1.....	68
4.7 Rack Mounting.....	69
4.8 Connecting External Expansion Modules.....	71
4.9 Grounding.....	73
4.10 Network Connection.....	74
4.11 Starting the System.....	75
4.11.1 Checking the LEDs.....	76
4.12 Changing the System to Standard Mode.....	77
4.13 Connecting Phones.....	78

5. Initial Configuration

5.1 Setting the System Locale.....	81
5.2 Select Key System or PBX System Mode.....	82
5.3 Changing the IP Address Settings.....	83
5.4 Changing the Default Passwords.....	84
5.5 Extension Numbering.....	85
5.6 Entering Licenses.....	86

6. Additional Processes

6.1 Switching Off an IP Office System.....	91
6.2 Rebooting an IP Office System.....	92
6.3 Memory Card Removal.....	93
6.4 Changing Components.....	95
6.5 Upgrading the IP Office Software.....	97
6.5.1 Using the Upgrade Wizard.....	98
6.5.2 Using an SD Card.....	100
6.6 Out of Building Telephone Installations.....	101
6.6.1 DS Phones.....	102
6.6.2 Analog Phone Barrier Box.....	103
6.6.3 Rack Mounting Barrier Boxes.....	104
6.7 Using the External Output Port.....	105
6.7.1 Port Connection.....	105
6.8 Reset Button.....	106
6.9 AUX Button.....	106
6.10 DTE Port Maintenance.....	107
6.10.1 DTE Port Settings.....	107
6.10.2 Erasing the Configuration.....	108
6.10.3 Defaulting Security Settings.....	110
6.10.4 Erasing the Operational Firmware.....	111

7. SD Card Management

7.1 Booting from the SD Cards.....	117
7.2 Creating an IP Office SD Card.....	119
7.3 Viewing the Card Contents.....	120
7.4 Backing Up the System SD Card.....	121
7.4.1 Backing Up the Primary Folder.....	121
7.4.2 Restore from the Backup Folder.....	122
7.4.3 Backing Up to the Optional Card.....	123
7.4.4 Restoring from the Optional Card.....	124
7.5 Upgrading Card Software.....	126
7.5.1 Upgrading Remotely Using Manager.....	127
7.5.2 Upgrading the SD Card Locally.....	127
7.5.3 Upgrading Using an Optional SD Card.....	128
7.6 Removing SD Cards.....	129
7.6.1 Card Shutdown.....	129
7.6.2 Card Startup.....	130

7.6.3 System Shutdown.....	131	8.8.3 T7316e KEM.....	186
8. System Components		8.9 Ancillary Systems.....	187
8.1 IP500v2 Control Unit.....	135	8.9.1 Digital Mobility Solution.....	187
8.2 IP500 Base Cards.....	137	8.10 Applications.....	188
8.2.1 Analog Phone.....	139	8.10.1 Manager.....	188
8.2.2 ATM Combination Card.....	140	8.10.2 Monitor.....	189
8.2.3 BRI Combination Card.....	141	8.10.3 System Status Application (SSA).....	190
8.2.4 Digital Station.....	142	8.10.4 TAPI.....	191
8.2.5 ETR6 Card.....	143	8.10.5 IP Office Ports.....	192
8.2.6 TCM8 Digital Station.....	144	8.11 Physical Ports.....	195
8.3 IP500 Trunk Daughter Cards.....	145	8.11.1 Cables.....	196
8.3.1 Analog Trunk Card.....	146	8.11.2 ANALOG Port.....	198
8.3.2 BRI Trunk Cards.....	147	8.11.3 AUDIO Port.....	198
8.3.3 PRI Trunk Cards.....	148	8.11.4 BRI Port (To).....	199
8.4 IP500 Expansion Modules.....	149	8.11.5 DC I/P Port.....	200
8.4.1 Analog Trunk 16.....	150	8.11.6 DS Ports.....	200
8.4.2 Digital Station.....	152	8.11.7 EF Port.....	201
8.4.3 Digital Station A.....	154	8.11.8 RS232 DTE Port.....	201
8.4.4 Phone.....	157	8.11.9 ETR Port.....	202
8.5 Feature Keys.....	159	8.11.10 EXPANSION Port.....	203
8.5.1 IP500v2 System SD Cards.....	159	8.11.11 EXT O/P Port.....	203
8.6 Mounting Kits.....	161	8.11.12 LAN Port.....	204
8.6.1 IP500 Wall Mounting Kits.....	161	8.11.13 PF Port.....	205
8.6.2 IP500 Rack Mounting Kit.....	162	8.11.14 PHONE (POT) Port.....	206
8.6.3 IP400 Rack Mounting Kit.....	162	8.11.15 PRI Port.....	207
8.6.4 Barrier Box Rack Mounting Kit.....	162	8.11.16 TCM Port (RJ21).....	208
8.7 Phones.....	163	8.11.17 TCM Port (RJ45).....	209
8.7.1 1403.....	164	8.12 Licences.....	210
8.7.2 1408.....	165	8.12.1 System Edition Licenses.....	211
8.7.3 1416.....	166	8.12.2 Trunk Licensing.....	212
8.7.4 3910.....	167	8.12.3 User Licenses.....	212
8.7.5 3920.....	167	8.12.4 Trial Licenses.....	213
8.7.6 9404.....	168	9. Safety Statements	
8.7.7 9408.....	168	9.1 Lithium Batteries.....	216
8.7.8 9504.....	169	9.2 Lightning Protection/Hazard Symbols.....	216
8.7.9 9508.....	169	9.3 Trunk Interface Modules.....	217
8.7.10 Audio Conferencing Unit.....	170	9.4 Further Information and Product Updates.....	218
8.7.11 ETR 6, ETR 6D.....	171	9.5 Port Safety Classification.....	218
8.7.12 ETR 18, ETR 18D.....	172	9.6 EMC Directive.....	219
8.7.13 ETR 34D.....	173	9.7 Regulatory Instructions for Use.....	220
8.7.14 M7100.....	174	9.7.1 Australia.....	220
8.7.15 M7100N.....	174	9.7.2 Canada.....	220
8.7.16 M7208.....	175	9.7.3 China.....	221
8.7.17 M7208N.....	175	9.7.4 European Union.....	222
8.7.18 M7310.....	176	9.7.5 New Zealand.....	222
8.7.19 M7310N.....	176	9.7.6 FCC Notification.....	223
8.7.20 M7324.....	177	9.7.7 Compliance with FCC Rules.....	225
8.7.21 M7324N.....	177	Index.....	227
8.7.22 T7000.....	178		
8.7.23 T7100.....	178		
8.7.24 T7208.....	179		
8.7.25 T7316.....	180		
8.7.26 T7316E.....	181		
8.7.27 T7406, T7406e.....	182		
8.8 Phone Add-Ons.....	183		
8.8.1 DBM32.....	184		
8.8.2 KLM Module.....	185		

Chapter 1.

System Overview

1. System Overview

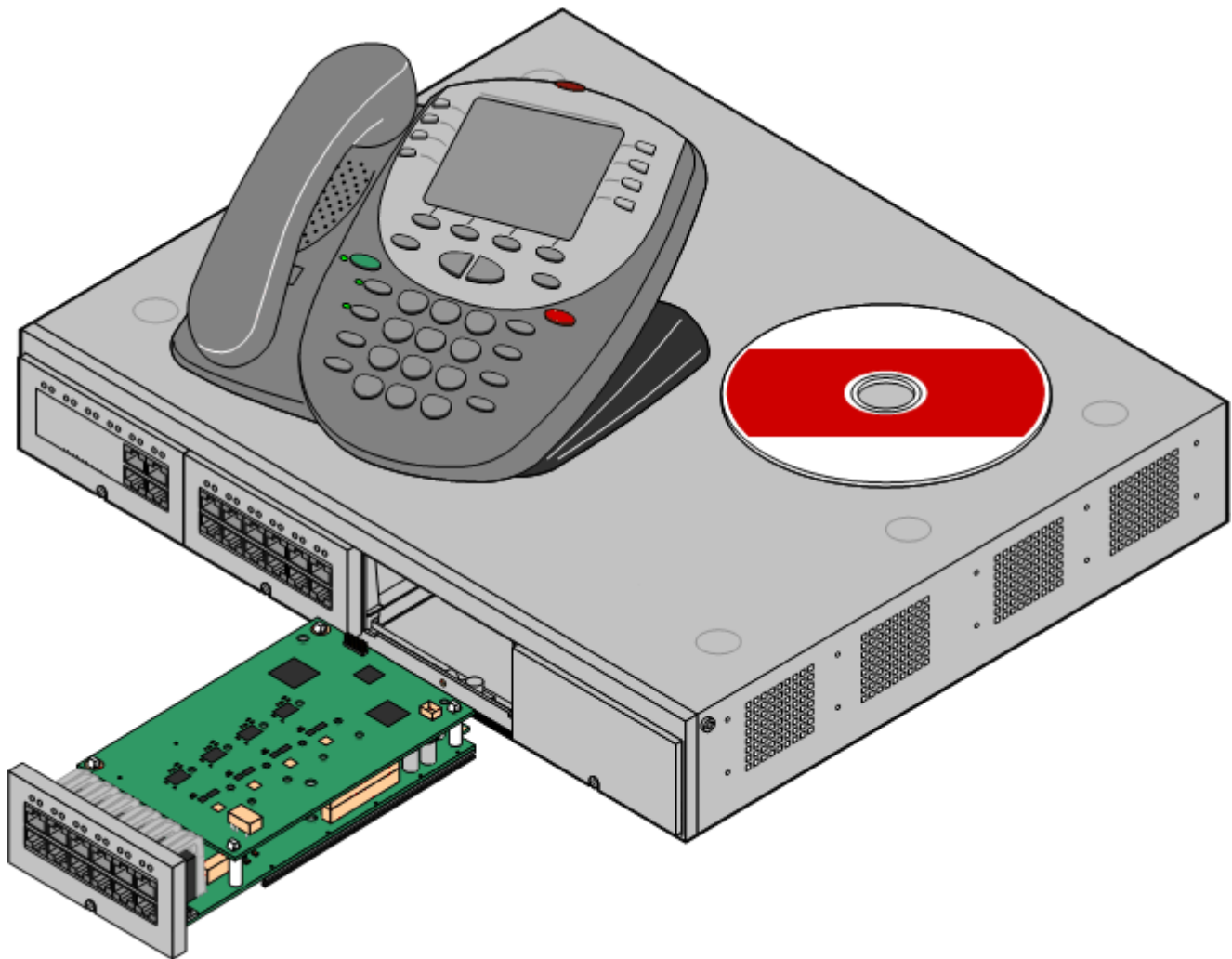

This documentation is intended to assist with the installation of the core components of an Avaya IP Office Essential Edition - Quick Version mode telephone system. It describes those components and factors that should be considered for an installation.



- The IP Office is a converged voice and data communications system. It should therefore only be installed by persons with telephony experience.
- Installers must be trained on IP Office systems. Through its [Avaya University](#) (AU), Avaya provides a range of training courses including specific IP Office implementation and installation training. It also provides certification schemes for installers to achieve various levels of IP Office accreditation.
- It is the installer's responsibility to ensure that all installation work is done in accordance with local and national regulations and requirements. It is also their responsibility to accurately establish the customer's requirements before installation and to ensure that the installation meets those requirements.
- You should read and understand this documentation before installation. You should also obtain and read the Avaya Technical Bulletins relevant to recent IP Office software and hardware releases to ensure that you are familiar with any changes to the IP Office equipment and software.

Additional Documentation

The following components of IP Office are outside the range of a basic IP Office installation. They are covered by separate installation and configuration documentation. If those components are to be part of the IP Office system installation, that documentation should be obtained, read and understood prior to the installation.

- *IP Office Product Description*
Covers the features provided by IP Office 7.0 - IP Office Essential Edition - Quick Version.
- *IP Office Essential Edition - Quick Version Installation Manual*
Covers the equipment supported and the installation of that equipment.
- *IP Office Essential Edition - Quick Version Manager*
Covers the system programming that can be performed using the IP Office Manager application.
- *IP Office Essential Edition - Quick Version Phone Based Administration Manual*
Covers the range of system programming that can be performed from the first two extensions in the system.
-  IP Office Technical Bulletins
Ensure that you have obtained and read the IP Office Technical Bulletin relating to the IP Office software release which you are installing. This bulletin will contain important information that may not have been included in this manual. IP Office Technical Bulletins are available from the [Avaya support](http://support.avaya.com) website (<http://support.avaya.com>).
-  Upgrade Licenses
Some upgrades may require entry of upgrade licenses.

Equipment Availability

SAP codes and details of specific items within this documentation are for reference only. Items available in any specific locale should be confirmed against the local Avaya IP Office price list for that locale. The local price list may also include additional items relative to the installation requirements of that locale.

This documentation covers the equipment supported by IP Office Release 6. That includes equipment supported but no longer available as new from Avaya.

Repair

IP Office systems do not contain any user serviceable or repairable components. If a faulty unit is suspected the whole unit should be replace.

- IP400 control units should only be opened where indicated for the installation of IP400 cards.
- IP500 control units should not be opened under any circumstances.

RoHS

RoHS is a European Union directive for the Removal of Certain Hazardous Substances from Electrical and Electronic Equipment. Similar legislation has been or is being introduced in a number of other countries. Avaya has decided to make its global product range compliant with the requirements of RoHS.

The actions taken vary

- In some cases equipment has been discontinued and is no longer available from Avaya.
- In some cases new manufactured stock has been made RoHS compliant and keeps its existing SAP code.
- In other cases the equipment has been replaced by a new RoHS compliant alternative with new SAP codes.
- The SAP codes within this document are for RoHS compliant equipment unless otherwise stated.

1.1 IP Office Modes

IP Office systems based on the IP500v2 control unit can run in a number of modes:

- IP Office Standard Version
- IP Office Essential Edition - Quick Version
- IP Office Essential Edition - Norstar Version
- IP Office Essential Edition - PARTNER® Version
- Avaya Branch Gateway
This is a special mode used for B5800 control units and is not covered by this documentation. Refer to the separate Avaya Branch Gateway documentation.

IP500 control units only run in IP Office Standard Version mode. The default mode used for IP500v2 systems is determined by the System SD card present when the system is first installed.

- IP Office U-Law
A system fitted with this type of card will default to U-Law telephony. For pre-IP Office Release 7.0 software, the system will default to IP Office standard mode. For IP Office Release 7.0+, the system will default to IP Office Essential Edition - Quick Version mode *Key System* operation. Intended for North American locales.
- IP Office A-Law
A system fitted with this type of card will default to A-Law telephony. For pre-IP Office Release 7.0 software, the system will default to IP Office standard mode. For IP Office Release 7.0+, the system will default to IP Office Essential Edition - Quick Version mode *PBX System* operation. Intended for locales outside North America.
- IP Office Partner Version
A system fitted with this type of card will default to U-Law telephony and IP Office Essential Edition - PARTNER® Version mode *Key System* operation. Supported only in North American locales.
- IP Office Norstar Version
A system fitted with this type of card will default to A-Law telephony and IP Office Essential Edition - Norstar Version mode *Key System* operation. Supported only in Middle East and North African locales.

Overall Capacity

		IP Office Essential Edition - PARTNER® Version	IP Office Essential Edition - Norstar Version	IP Office Essential Edition - Quick Version	IP Office Standard Version
Extensions	Maximum Extensions	100 ^[1]	100 ^[1]	100 ^[1]	384
Trunks	Maximum Trunks	64	62	64	^[5]
	- Maximum Analog Trunks	32	32	32	208
	- Maximum BRI Channels ^[3]	–	12	12	32
	- Maximum PRI Channels ^[4]	24	30	30	120
	- Maximum SIP Channels ^[2]	20	20	20	^[5]
	- Maximum H323 IP Channels	–	–	–	^[5]

1. 100 Extension in 3-digit extension numbering mode only. 48 extensions in 2-digit extension numbering mode.

- In non-IP Office Standard Version mode the system assumes that the base control unit is always fully populated with up to 24 extensions, either real or phantom or a mix, to which it assigns extension numbers in sequence. It does this before assigning extension numbers to any real extensions on attached external expansion modules up to the system extension limit. If the system extension limit has not been exceeded, any remaining extension numbers are assigned to additional phantom extensions.
2. Non-IP Office Standard Version mode systems support 3 SIP channels without licenses. Additional channels up to the limit require licenses. IP Office Standard Version mode systems require licenses for all channels. In all modes, voice compression hardware resources are also required for SIP support.
 3. Non-IP Office Standard Version mode systems do not support both BRI and PRI trunks in the same system. IP Office Standard Version mode systems support both BRI and PRI trunks in the same system.
 4. Non-IP Office Standard Version mode systems are restricted to 12 BRI channels regardless of the BRI hardware installed.
 5. Capacity is dependent on licenses, voice compression resources and available bandwidth.



•

1.1.1 Hardware Support Summary

Note that even where indicated as supported, the availability and support of equipment may still be subject to local restrictions.

		IP Office Essential Edition - PARTNER® Version	IP Office Essential Edition - Norstar Version	IP Office Essential Edition - Quick Version	IP Office Standard Version
Control Unit	IP500v2 Control Unit	✓	✓	✓	✓
	IP500 Control Unit	–	–	–	✓
IP500 Base Cards	IP500 Digital Station Card	✓ 4	✓ 4	✓ 4	✓ 3
	IP500 Analog Phone 2/8 Cards	✓ 4	✓ 4	✓ 4	✓ 4
	IP500 TCM8 Card ^[1]	✓ 4	✓ 4	✓ 4	✓ 4
	IP500 VCM 32/64 Base Cards	–	–	–	✓ 2
	IP500 Legacy Card Carrier	–	–	–	✓
	IP500 4-Port Expansion Card	–	–	–	✓ 1
	IP500 BRI Combination Card ^[1]	–	✓ 2	✓ 2	✓
	IP500 ATM Combination Card ^[1]	✓ 2	✓ 2	✓ 2	✓ 2
	IP500 ETR6 Card ^[1]	✓ 3	–	✓ 3	–
IP500 Trunk Daughter Cards	Analog Trunk Card	✓	✓	✓	✓
	BRI Trunk Cards ^[5]	–	✓	✓	✓
	PRI Trunk Card ^[6]	✓ 1	✓ 1	✓ 1	✓ 4
External Expansion Modules	Number of Modules ^[3]	8	8	8	12
	Digital Station 16/30	✓	✓	✓	✓
	Digital Station 16A/30A	✓	✓	✓	✓
	Phone 8/16/30	✓	✓	✓	✓
	Analog Trunk 16 ^[4]	–	–	✓	✓
	BRI So8	–	–	–	✓
Telephone Types	ETR Phones (<i>ETR ports</i>)	✓	–	✓	–
	BST Phones (<i>TCM ports</i>)	✓	✓	✓	✓
	DS Phones (<i>DS ports</i>)	✓	✓	✓	✓
	H323 IP Phones (<i>LAN</i>)	–	–	–	✓
	SIP IP Phones (<i>LAN</i>)	–	–	–	✓
	DECT R4 (<i>LAN</i>)	–	–	–	✓
	DECT DMS (<i>TCM ports</i>)	✓	✓	✓	✓
Voicemail	Embedded Voicemail	✓	✓	✓	✓
	Voicemail Pro	–	–	–	✓

1. Not supported by IP500 control units. Support by IP500v2 Control units only.
2. Only 2 combinations cards are supported in a control unit, regardless of type.
3. External expansion modules can be added so long as the overall limit for extensions and trunks is not exceeded. On non-IP Office Standard Version mode systems, only a maximum of one Analog Trunk 16 module is supported.
4. The IP500 Analog Trunk 16 external expansion module is only supported on systems in North American locales.
5. A mix of BRI and PRI trunks is not supported by IP Office Essential Edition - Norstar Version and IP Office Essential Edition - Quick Version.
6. IP Office Essential Edition - PARTNER® Version, IP Office Essential Edition - Norstar Version and IP Office Essential Edition - Quick Version only support a single-port PRI card.

1.1.2 Feature Support Summary

		IP Office Essential Edition - PARTNER® Version	IP Office Essential Edition - Norstar Version	IP Office Essential Edition - Quick Version	IP Office Standard Version
Administration	Phone Based Administration	✓	✓	✓	–
	Manager - Simplified View	✓	✓	✓	–
	Manager - Advanced View	–	–	–	✓
IP Office Applications	Customer Call Reporter	–	–	–	✓
	IP Office Manager	✓	✓	✓	✓
	Monitor (System Monitor)	✓	✓	✓	✓
	one-X Portal for IP Office	–	–	–	✓
	Phone Manager	–	–	–	✓
	SoftConsole	–	–	–	✓
	System Status Application	✓	✓	✓	✓
	TAPI (1st Party)	✓	✓	✓	✓
	TAPI (3rd Party)	–	–	–	✓
Voicemail Pro	–	–	–	✓	
Locales		Canada, Mexico, United States	Bahrain, Egypt, Kuwait, Morocco, Oman, Pakistan, Qatar, Saudi Arabia, South Africa, Turkey, United Arab Emirates	Argentina, Australia, Bahrain, Belgium, Brazil, Canada, Chile, China, Colombia, Denmark, Egypt, Finland, France, Germany, Greece, Hong Kong, Hungary, Iceland, India, Italy, Korea, Kuwait, Mexico, Morocco, Netherlands, New Zealand, Norway, Oman, Pakistan, Peru, Poland, Portugal, Qatar, Russia, Saudi Arabia, Singapore, South Africa, Spain, Sweden, Switzerland, Taiwan, Turkey, United Arab Emirates, United Kingdom, United States, Venezuela.	
Voicemail Languages	Embedded Voicemail	Arabic, Chinese-Mandarin, Chinese-Cantonese, Danish, Dutch, English-UK, English-US, Finnish, French, French-Canadian, German, Italian, Korean, Norwegian, Portuguese, Portuguese Brazilian, Russian, Swedish, Spanish, Spanish-Latin, Spanish-Argentinean.			
	Voicemail Pro	–	–	–	As above plus: Hungarian, Greek, Polish. Minus: Arabic.
Default Configuration Access	User Name	Administrator	Administrator	Administrator	Administrator
	Password	password	password	password	Administrator
Default Upgrade	Password	password	password	password	password

1.2 IP500v2 System Components

The following are the typical components of an IP Office system based on an IP500v2 control unit.

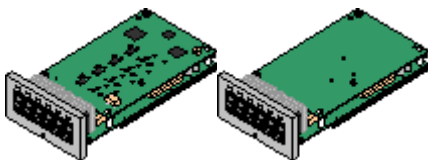
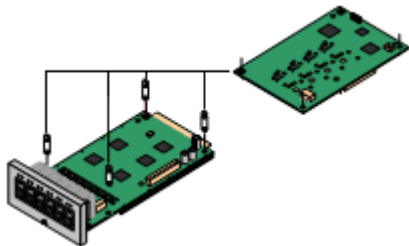
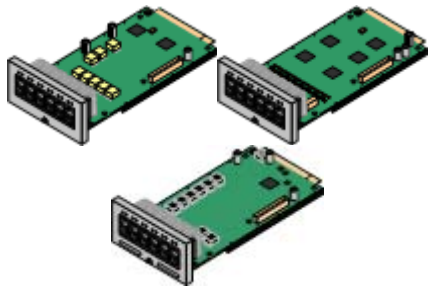
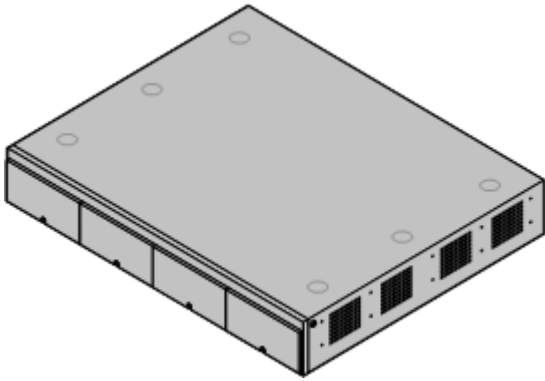

VK00nDd15SDvXoxkw9cR9x_jOXr_AWz9

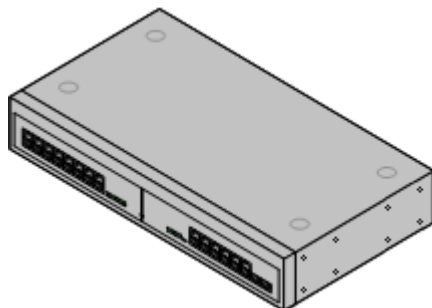

- [IP Office IP500v2 System Unit](#) ^[13b]
The control unit holds the main configuration and performs the routing and switching for telephone calls and data traffic. Each control unit includes 4 slots for optional base cards to support trunk and phone extension ports.
-  [Avaya SD Card](#) ^[29]
This uniquely numbered dongle is used to validate license keys entered into the system's configuration to enable features. A dongle is mandatory for correct system operation even if no licensed features are being used. IP500v2 control units use an Avaya SD card which is slotted into the rear of the control unit. This card also provides embedded voicemail support and storage for system software files.
- [IP500 Base Cards](#) ^[15]
The IP500v2 control unit has slots for up to 4 IP500 base cards. These can be used to add ports for analog extensions, digital extensions, voice compression channels and other resources.
 - [IP500 Digital Station Base Card](#) ^[142]
 - [IP500 Analog Phone Base Card](#) ^[139]
 - [IP500 TCM8 Base Card](#) ^[144]
 - [IP500 ETR6 Base Card](#) ^[143]
- [IP500 Trunk Daughter Cards](#) ^[17]
Many of the IP500 base cards can be fitted with an IP500 daughter card in order to support various types of trunk connections.
 - [IP500 Analog Trunk Card](#) ^[146]
 - [IP500 BRI Trunk Card](#) ^[147]
 - [IP500 PRI Trunk Card](#) ^[148]
- [IP500 Combination Cards](#) ^[15]
These card are pre-paired base and daughter cards. They provide 6 digital station ports, 2 analog phone ports, 10 voice compression channels and either 4 analog trunk ports or 4 BRI channels (2 ports). The trunk daughter card cannot be removed or replaced with another type.
- [License Keys](#) ^[213]
Various IP Office features and applications require a license key to be entered into the system's configuration. Each key is a 32-character text string unique to the feature being activated and the serial number of the Feature Key dongle installed in the system.
- [IP500 External Expansion Modules](#) ^[18]
Additional ports can be added using a number of IP500 external expansion modules.
 - Systems running in IP Office Essential Edition - Quick Version mode support up to 8 external expansion modules so long as the system extensions limit is not exceeded.
- [Power Supplies](#) ^[20]
The IP500 control unit has an internal power supply unit. Each external expansion module is supplied with an external power supply unit. Additional power supply units may also be required for IP phones and some phone add-ons.

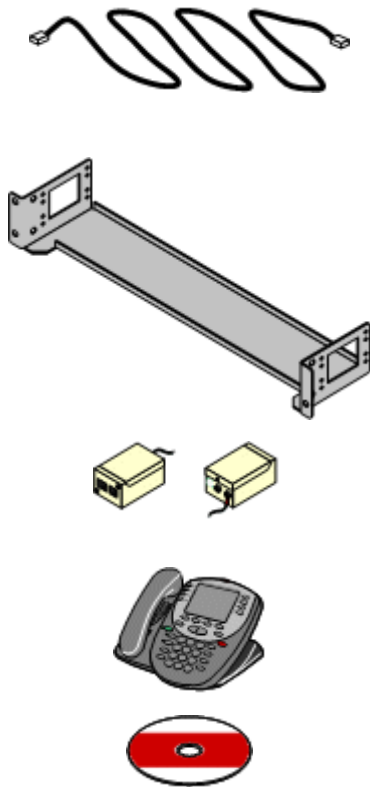

- [Power Cords](#)^[21]
Depending on the locale, different power cords need to be ordered for each control unit, external expansion module and any phones or devices using external power supply units.
- [Cables](#)^[23]
The IP Office is designed primarily for connection to a structured cabling system using CAT3 UTP cabling. This approach allows telephone and data traffic to share the same wiring infrastructure and simplifies equipment moves.
- [Mounting Kits](#)^[27]
The control unit can be used free-standing, with external expansion modules stacked above it. With optional rack mounting kits, the control unit and external expansion modules can also be rack mounted. Alternatively with an optional wall mounting kit the IP500 control unit can be wall mounted. IP500 external expansion modules can also be wall mounted.
- [Surge Protectors and Barrier Boxes](#)^[26]
Where the installation includes extensions in other buildings additional protective equipment is required. This equipment may also be required in areas where the lightning risk is high.
- [Phones](#)^[30]
IP Office systems support a variety of Avaya digital and IP phones plus analog phones.
- Application DVDs
The IP Office applications can be ordered on a number of DVDs. In addition they can be downloaded from the IP Office section of the [Avaya support](http://support.avaya.com) web site (<http://support.avaya.com>).

1.3 Control Unit Cards

1.3.1 IP500 Base Cards

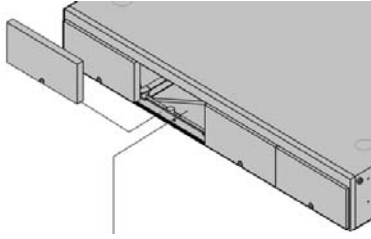

The IP500 and IP500v2 control units have 4 slots for the insertion of IP500 base cards. The slots are numbered 1 to 4 from left to right. Normally they can be used in any order, however if the capacity for a particular type of card is exceeded, the card in the rightmost slot will be disabled.

Each base card includes an integral front panel with ports for cable connections. Typically the first 8 ports on the left are for connection of extension devices. The 4 ports on the left are used for connection of trunks if a [trunk daughter card](#) is added to the base card.

[IP500 Digital Station Base Card](#)

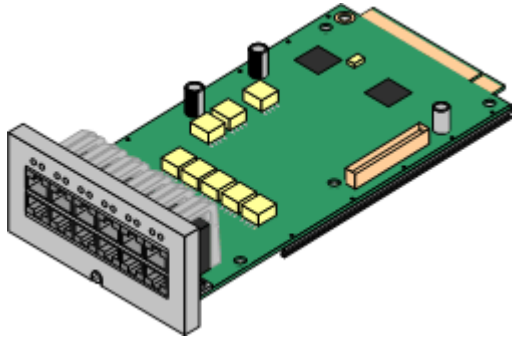

This card provides 8 DS (digital station) ports for the connection of Avaya digital phones.

- The card can be fitted with an [IP500 trunk daughter card](#) which uses the base card ports for trunk connection.
- Maximum: 4 per control unit.
 - Connections for 4100, 7400, M-Series and T-Series phones use the IP500 TCM8 Digital Station card.

[IP500 Analog Phone Base Card](#)

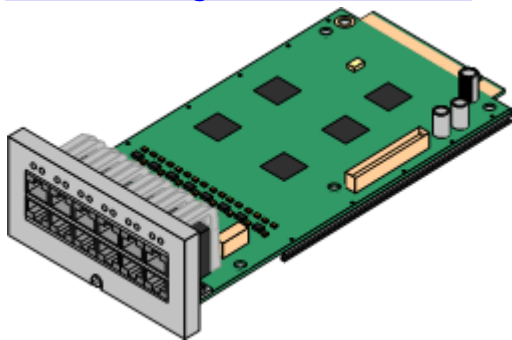

The card is available in two variants, supporting either 2 or 8 analog phone ports.

- The card can be fitted with an [IP500 trunk daughter card](#) which uses the base card ports for trunk connection.
- Maximum: 4 per control unit.
 - The analog phone ports do not include a ringing capacitor. Where this is a requirement, connection should be via a Master socket containing ringing capacitors.
 - If fitted with an IP500 Analog Trunk daughter card, during power failure phone port 8 is connected to analog trunk port 12.

[IP500 TCM8 Digital Station Card](#)

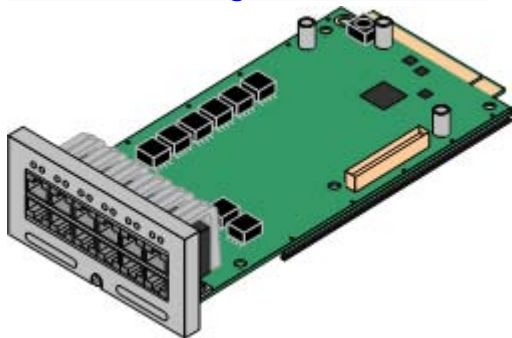

This card provides 8 TCM (digital station) ports for the connection of Avaya 4100, 7400, M-Series and T-Series phones.

- The card can be fitted with an [IP500 trunk daughter card](#) which uses the base card ports for trunk connection.
- Maximum: 4 per control unit per IP500v2 control unit.

[IP500 BRI Combination Card](#)

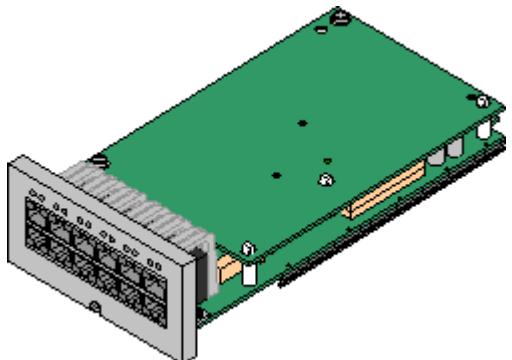

This card provides 6 digital station ports (1-6), 2 analog extension ports (7-8) and 2 BRI trunk ports (9-10, 4 channels). The card also includes 10 voice compression channels.

- This card has a pre-installed [IP500 BRI trunk daughter card](#).
- Maximum: 2 combination cards per IP500v2 control unit, regardless of type.
 - IP Office Essential Edition - Quick Version mode systems are limited to a maximum of 12 BRI channels.

[IP500 ATM Combination Card](#) ¹⁴⁰

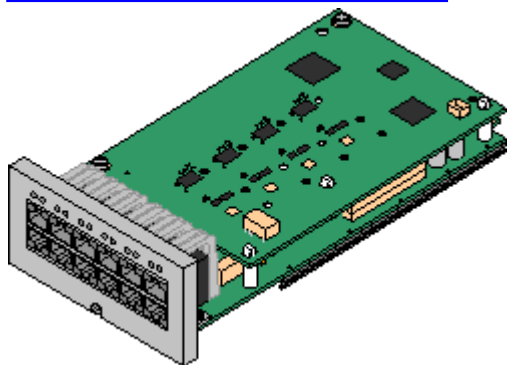

This card provides 6 digital station ports (1-6), 2 analog extension ports (7-8) and 4 analog trunk ports (9-12). The card also includes 10 voice compression channels.

- This card has a pre-installed [IP500 analog trunk daughter card](#) ¹⁷.
- Maximum: 2 combination cards per IP500v2 control unit, regardless of type.
 - The analog phone ports do not include a ringing capacitor. Where this is a requirement, connection should be via a Master socket containing ringing capacitors.
 - If fitted with an IP500 Analog Trunk daughter card, during power failure phone port 8 is connected to analog trunk port 12.

[IP500 ETR6 Base Card](#) ¹⁴³

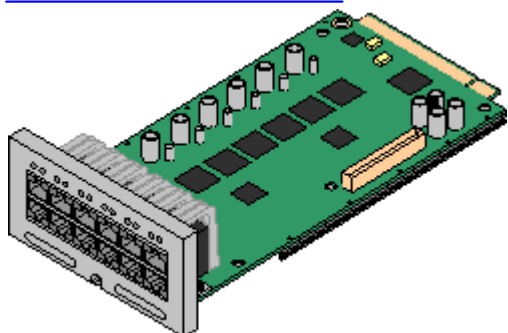

This card is only supported in an IP500v2 control unit running in IP Office Essential Edition - PARTNER® Version or IP Office Essential Edition - Quick Version mode.

It provides 6 ETR ports for connection of ETR phones. 2 Analog extension ports are also provided for emergency use only with an analog trunk card.

- The card can be fitted with an IP500 trunk daughter card which uses the base card ports for trunk connection.
- Maximum: 3 per IP500v2 control unit.
- The analog phone ports do not include a ringing capacitor. Where this is a requirement, connection should be via a Master socket containing ringing capacitors.
- If fitted with an IP500 Analog Trunk daughter card, during power failure phone ports 7 and 8 are connected to analog trunk port 12. However during normal operation analog phone ports 7 and 8 are not useable.

1.3.2 IP500 Trunk Cards

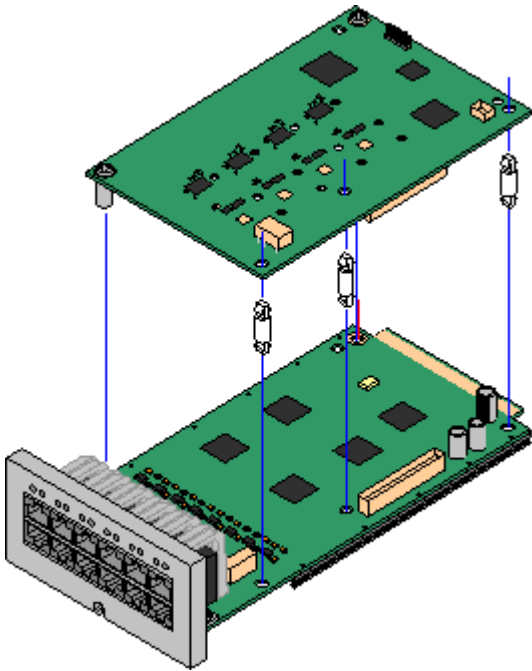

Most [IP500 base cards](#)^[15] can be fitted with an IP500 trunk daughter cards to support the connection of trunks to the base card.

Each daughter card is supplied with the stand off pillars required for installation and a label to identify the daughter cards presence on the front of the base card after installation.

- IP500 Combination cards are pre-fitted with a trunk daughter card which cannot be removed or changed for another type of trunk daughter card.

[IP500 Analog Trunk Daughter Card](#)^[146]

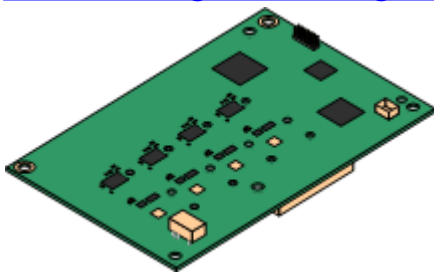

This card allows the base card to support 4 analog loop-start trunks.

- The analog phone ports do not include a ringing capacitor. Where this is a requirement, connection should be via a Master socket containing ringing capacitors.
- If fitted with an IP500 Analog Trunk daughter card, during power failure phone port 8 is connected to analog trunk port 12.
- Maximum: 4 per control unit.

[IP500 PRI-U Trunk Daughter Card](#)^[148]

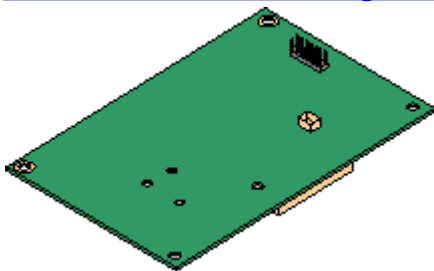

This card allows the base card to support up to 2 PRI trunk connections. The card is available in single and dual port variants. The card can be configured for E1 PRI, T1 robbed bit, T1 PRI or E1R2 PRI trunks.

- Maximum: 1 single port card per control unit.
- The IP Office system supports 8 unlicensed B-channels on each IP500 PRI-U port fitted. Additional B-channels, up to the capacity of ports installed and PRI mode selected require [IP500 Universal PRI \(Additional Channels\)](#)^[21] licenses added to the configuration. These additional channels consume the licenses based on which additional channels are configured as in-service from port 9 of slot 1 upwards. D-channels are not affected by licensing.

[IP500 BRI Trunk Daughter Card](#)^[147]

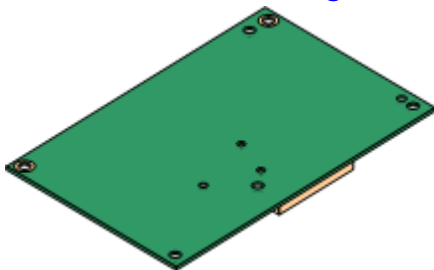

This card allows the base card to support up to 4 BRI trunk connections, each trunk providing 2B+D digital channels. The card is available in 2 port (4 channels) and 4 port (8 channels) variants.

- Maximum: 4 per control unit.
- IP Office Essential Edition - Quick Version mode systems are limited to a maximum of 12 BRI channels.

1.4 External Expansion Modules

These modules can be used to add additional ports to an IP Office systems. The number of external expansion modules supported depends on the control unit type. Each module uses an external [power supply unit](#) [20] supplied with the module. A locale specific [power cord](#) [21] for the PSU must be ordered separately.

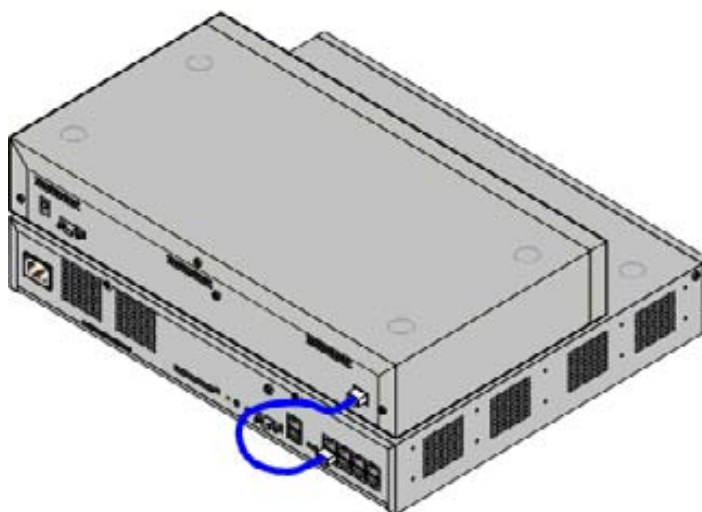

IP500 System with External Expansion Module

- Systems running in IP Office Essential Edition - Quick Version mode support up to 8 external expansion modules so long as the system extensions limit is not exceeded.
- Each external expansion module is supplied with a blue 1 meter (3'3") expansion interconnect cable. This cable must be used when connecting to expansion ports on the rear of a control unit.

IP500 External Expansion Modules

Expansion modules include an external power supply unit (PSU) and a 1m blue interconnect cable. They do not include a locale specific power cord for the external PSU or any phone extension cables.

Variant	Country	SAP Code
Digital Station		
I PO 500 Digital Station 16	All	700449499
I PO 500 Digital Station 30	All	700426216
I PO 500 Digital Station 16A	All	700500699
I PO 500 Digital Station 30A	All	700500698
Analog Phone		
I PO 500 Phone 16	All	700449507
I PO 500 Phone 30	All	700426224
Others		
I PO 500 Analog Trunk 16	North America	700449473

1.4.1 IP500 External Expansion Modules

The following IP500 external expansion modules are supported by IP Office Release 7.0. Each module uses an external [power supply unit](#) [20] supplied with the module. A locale specific [power cord](#) [21] for the PSU must be ordered separately.

If being rack mounted, these units use the IP500 rack mounting kit. They can be wall mounted using the new wall mounting kit V2.

- Systems running in IP Office Essential Edition - Quick Version mode support up to 8 external expansion modules so long as the system extensions limit is not exceeded.
- [IP500 Digital Station Module](#) [152]
Provides, depending on variant, an additional 16 or 30 [DS](#) [200] ports for supported [Avaya DS digital phones](#) [30].

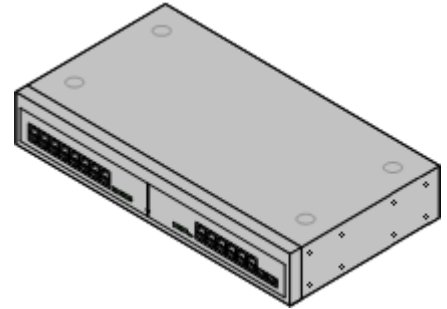

- [IP500 Digital Station A Module](#) [154]
Provides, depending on variant, an additional 16 or 30 [TCM](#) [200] ports for supported [Avaya TCM digital phones](#) [30]. Supported by IP500v2 only.

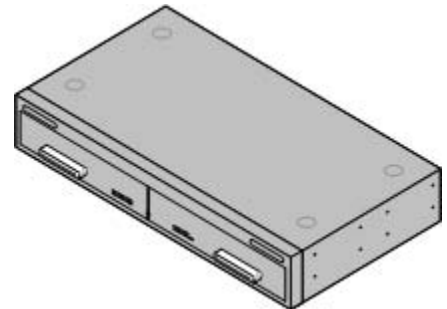

- [IP500 Phone Module](#) [157]
Provides, depending on variant, an additional 16 or 30 [PHONE](#) [200] ports for analog phones.

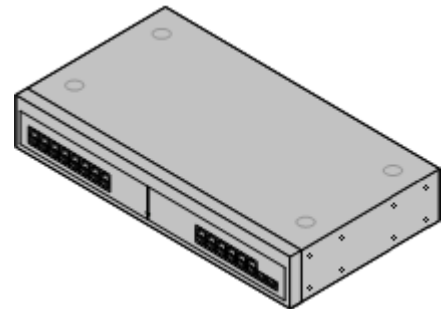

1.5 Power Supplies and Cables

All IP Office control units and external expansion modules either have an internal power supply unit or are supplied with an external power supply unit.

1.5.1 Power Supplies

The IP500 and IP500v2 control units have an internal power supply unit and so only require a suitable [locale specific power cord](#) and a power outlet that includes a switch. Note that if the power cord includes an earth lead, the power outlet must be connected to a protective earth.

External expansion modules are all supplied with an external power supply unit (PSU). These PSUs include an integral 1.5 meter lead for connection to the control unit or expansion module. A [power cord](#) for connection from the PSU to the power outlet is not included as this varies by locale. The appropriate power cord must be ordered separately or sourced locally.

Additional power supply units are required for 4450, EU24, XM24 and T3 DSS add-on modules and may also be required for Avaya IP phones.

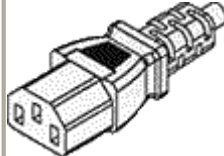

Area	Type	Used on:	Connector Type
IP Office Control Units and External Expansion Modules	40W PSU	Analog, Digital Station V1, Phone V1.	IEC60320 C7 
	60W Earthed PSU	IP400 Digital Station V2, IP400 Phone V2, IP400 So8, IP500 Phone 30, IP500 Digital Station 30, IP500 Digital Station 16A, IP500 Digital Station 30A.	IEC60320 C13 

1.5.2 Power Supply Cords

Each control unit and expansion module requires a switched power outlet socket rated at 110-240V ac, 50-60Hz. Connection from that power outlet socket requires an appropriate locale specific power cord which is not supplied with the unit and must be ordered separately. Note that if the power cord includes an earth lead, the power outlet must be connected to a protective earth.

Power cords must not be attached to the building surface or run through walls, ceilings, floors and similar openings. Installation measures must be taken to prevent physical damage to the power supply cord, including proper routing of the power supply cord and provision of a socket outlet near the fixed equipment or positioning of the equipment near a socket outlet.

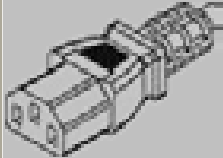
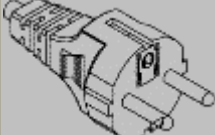
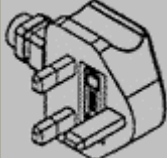
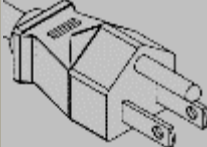
For locales not detailed below an appropriate power cord must be obtained locally.

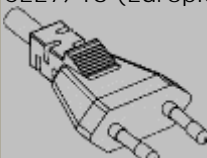
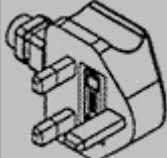
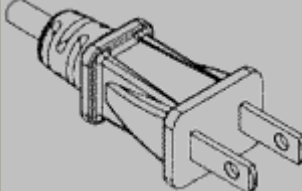
Power Cord Type	Power Outlet Plug Type	Locales	SAP Codes
Earthed Power Cords (IEC60320 C13)  Control Units <ul style="list-style-type: none"> • IP500v2. • IP500. IP400 External Expansion Modules <ul style="list-style-type: none"> • Digital Station V2. • Phone V2. IP500 External Expansion Modules <ul style="list-style-type: none"> • BRI So8. • Digital Station 16/30. • Phone 16/30. 	CEE7/7 (Schuko) 	Europe and South Africa.	700289762
	BS1363 	Czech Republic, Ireland, United Kingdom.	700289747
	NEMA5-15P / CS22.2 No. 42 	North, Central and South America.	700289770
Unearthed Power Cord (IEC60320 C7)  IP400 External Expansion Modules <ul style="list-style-type: none"> • Analog. • Digital Station V1. • Phone V1. IP500 External Expansion Modules <ul style="list-style-type: none"> • Analog Trunk 16. 	CEE7/16 (Europlug) 	Europe and South Africa.	700213382
	BS1363 	Czech Republic, Ireland, United Kingdom.	700213374
	NEMA1-15 	North, Central and South America.	700213390
		Korea.	700254519

*Older units were supplied with a 40W unearthed PSU and required an IEC60320 C7 power cord.

1.5.3 Power Supply Backup

The use of an Uninterrupted Power Supply (UPS) with any telephone system is strongly recommended. Even at sites that rarely lose electrical power, that power may occasionally have to be switched off for maintenance of other equipment. In addition, most UPSs also provide an element of power conditioning, reducing spikes and surges.

The capacity of UPS systems and the total equipment load the UPS is expected to support are usually quoted in VA. Where equipment load is quoted in Watts, multiply by 1.4 to get the VA load.

The calculation of how much UPS capacity is required depends on several choices.

- What equipment to place on the UPS?
Remember to include server PCs such as the voicemail. It is recommended that the total load on a new UPS is never greater than 75% capacity, thus allowing for future equipment.
- How many minutes of UPS support is required?
Actual UPS runtime is variable, it depends on what percentage of the UPSs capacity the total equipment load represents. For example, a 1000VA capacity UPS may only support a 1000VA (100%) load for 5 minutes. This relationship is not linear, the same UPS would support a 500VA (50%) load for 16 minutes. Therefore the lower the percentage of capacity used, the increasingly longer the UPS runtime, typically up to 8 hours maximum. Remember also that for most UPS's the ratio of discharge to full recharge time is 1:10.
- How many output sockets does the UPS provide?
Multiple UPS units may be required to ensure that every item of supported equipment has its own supply socket.

The web site <http://www.avayaups.com> provides a calculator into which you can enter the equipment you want supported on a UPS. It will then display various UPS options. The site uses VA values for typical IP Office systems. However, if more specific values are required for a particular system, the table below can be used to enter values.

Typical IP Office System	VA	Typical IP Office System	VA
IP500v2 System	230		
Individual Equipment	VA	Individual Equipment	VA
Analog 16 Module	88	Phone 30 Module	42
Digital Station 16 Module	34	Typical Server PC	600
Digital Station 30 Module	42	Typical Desktop PC	400
Phone 8 Module	17	Mid Span PSU - 6 ports	150
Phone 16 Module	23	Mid Span PSU - 12/24 ports	300

- The 1151D2 power supply unit for Avaya H.323 IP phones includes a backup battery. This typically provides 15 minutes backup at maximum load (20 Watts) and up to 8 hours at light load (2 Watts).

1.5.4 Cabling and Cables

The IP Office systems are designed primarily for use within an RJ45 structured cabling system using CAT3 unshielded twisted-pair (UTP) cabling and RJ45 sockets.

A structured cabling system is one where cables are run from a central RJ45 patch panel in the communications/data room to individual RJ45 sockets at user locations. All wires in each cable between the patch panel and the desk socket are connected straight through. This arrangement allows devices connected at the patch panel to be swapped to match the type of device that needs to be connected at the user socket. For example, making one user socket a phone port and another user socket a computer LAN port, without requiring any rewiring of the cables between the patch panel and the user location.

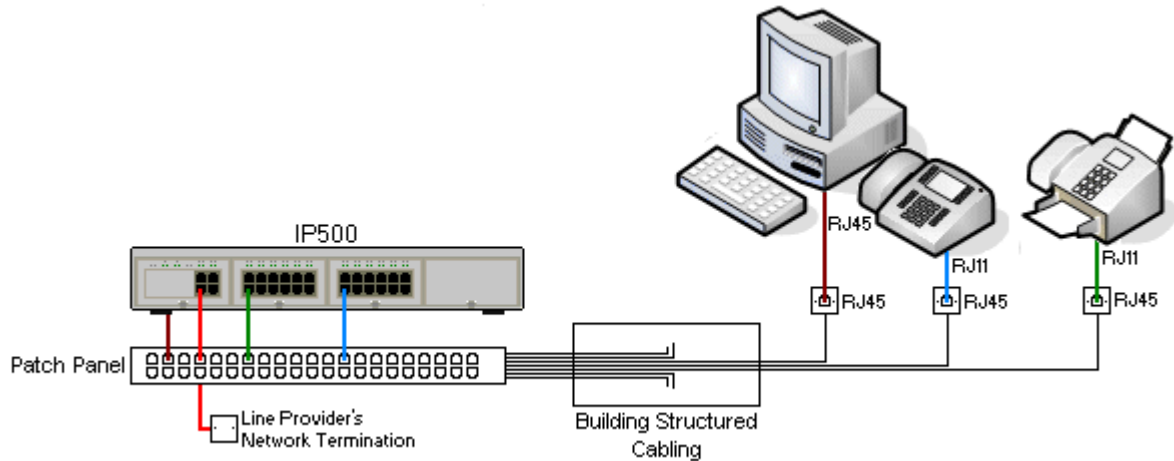

- **Traditional IDC Punchdown Wiring Installations**
Where necessary, the far end RJ45 plug can be stripped from IP Office cables and wired into traditional wiring systems using punch-block connectors. This type of installation should be performed by an experienced wiring technician.
- **Trunk Connections**
The majority of IP Office trunk ports use RJ45 connectors for acceptance of an RJ45-to-RJ45 cable. However, connection at the line provider's end may require use of a different plug type in order to match the line providers equipment.
- **RJ11 Phone Connectors**
Many phones use RJ11 sockets and are supplied with RJ11-to-RJ11 cables. RJ11 plugs can be inserted into RJ45 sockets and in many case the connection will work. However this is not recommended or supported as the connection lock is not truly positive and may become disconnected. An [RJ45-to-RJ11 cable](#)^[200] is available for these connections.

Standard IP Office Cables

The following are Avaya standard cables available for use with IP Office systems. The maximum length is applicable if the standard Avaya cable is replaced with an alternate cable.

Cable	Description	SAP Code	Standard Length	Maximum Length
9-Way DTE Cable ⁽¹⁰⁷⁾	Connects to control unit RS232 DTE port. 9-Way D-type plug to 9-way D-type socket.	–	2m/6'6".	2m/6'6".
Structured Cabling DS Line Cable ⁽²⁰⁶⁾	Connects from RJ45 sockets to RJ11 socketed DS and analog phones.	TT700047871	4m/13'2".	See table below.
BRI/PRI Trunk Cable ⁽¹⁹⁹⁾	Connects BRI/PRI trunk ports to the line provider's network termination point. RJ45 to RJ45. Red.	700213440	3m/9'10".	–
Expansion Interconnect Cable ⁽²⁰³⁾	Connects the control unit to expansion modules. RJ45 to RJ45. Blue.	700213457	1m/3'3".	1m/3'3".
LAN Cable ⁽²⁰⁴⁾	Connects from IP Office LAN ports to IP devices. RJ45 to RJ45. Grey.	700213481	3m/9'10".	100m/328'.

The table below details the maximum total cable distances for DS and analog extensions using different cable types.

Telephone	Unshielded Twisted-Pair (UTP) - 50nf/Km			CW1308
	AWG22 (0.65mm)	AWG24 (0.5mm)	AWG26 (0.4mm)	
1400 Series	1200m/3937'.	1000m/3280'.	670m/2200'.	400m/1310'.
9400/9500 Series	1200m/3937'.	1000m/3280'.	670m/2200'.	400m/1310'.
TCM (without power booster)	–	305m/1000'	–	–
" (with power booster)	–	790m/2600'	–	–
Analog Phones	1000m/3280'.	1000m/ 3280'.	400m/1640'.	800m/2620'.
ETR Phones	305m/1000'.	305m/1000'.	122m/400'.	122m/400'.



1.5.5 Grounding

All IP Office control units and external expansion modules must be connected to a functional ground. Where the unit is connected to a power outlet using a power cord with an earth lead, the power outlet must be connected to a protective earth.

Use of ground connections reduces the likelihood of problems in most telephony and data systems. This is especially important in buildings where multiple items of equipment are interconnected using long cable runs, for example phone and data networks.

In some cases, such as ground start trunks, in addition to being a protective measure, this is a functional requirement for the equipment to operate. In other cases it may be a locale regulatory requirement and or a necessary protective step, for example areas of high lightning risk.

-  **WARNING**
During installation do not assume that ground points are correctly connected to ground. Test ground points before relying on them to ground connected equipment.

The ground point on IP Office control units and external expansion modules are marked with a  or  symbol. Ground connections to these points should use a 14 AWG solid wire with either a green sleeve for a functional ground or green and yellow sleeve for a protective ground.

- **Additional protective equipment**
In addition to grounding, additional protective equipment will be required in the following situations. Refer to "[Out of Building Telephone Installations](#)"^[26].
 - On any Digital Station or Phones external expansion module connected to an extension located in another building.
 - In the Republic of South Africa, on all Analog Trunk external expansion modules (ATM16) and on any control units containing an analog trunk cards (ATM4/ATM4U).

1.5.6 Lightning Protection/Out-of-Building Connections

The following are the only supported scenarios in which wired extensions and devices outside the main building can be connected to the IP Office system. In these scenarios, additional protection, in the form of protective grounding and surge protectors, must be fitted.

-  **WARNING**
 The fitting of additional protection does not remove the risk of damage. It merely reduces the chances of damage.

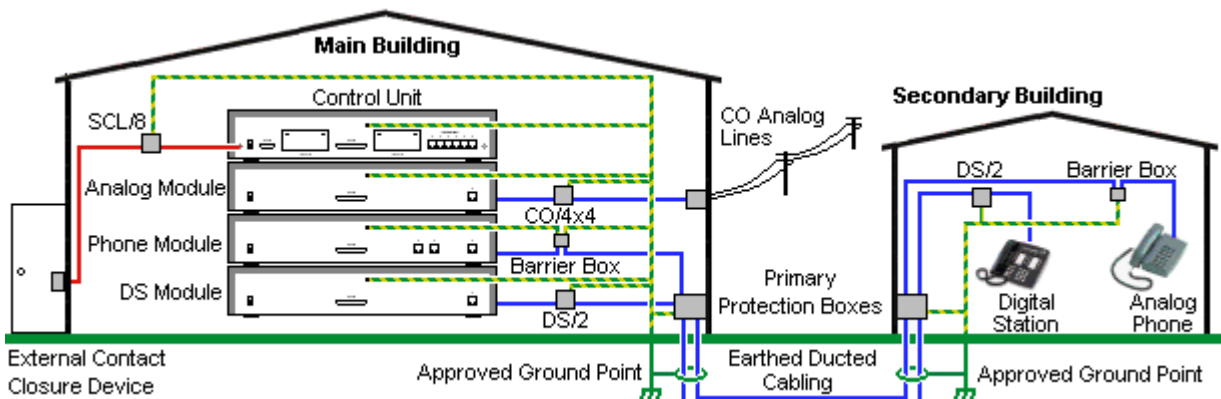

- Cables of different types, for example trunk lines, phone extensions, ground and power connections, should be kept separate.
- All cabling between buildings should be enclosed in grounded ducting. Ideally this ducting should be buried.
- A Primary Protection Box must be provided at the point where the cables enter the building. This should be three point protection (tip, ring and ground). Typically this would be gas tube protection provided by the local telephone company. The ground wire must be thick enough to handle all the lines being affected by indirect strike at the same time.

Connection Type	Protection Device Type	Requirement
Analog Phone Extensions Phones External expansion module (POT ^[206] or PHONE ^[206]) ports only.	IP Office Barrier Box ^[109] Supports a single connection. Maximum of 16 on any expansion module.	<ul style="list-style-type: none"> Connection from the expansion module to the phone must be via a surge protector at each end and via the primary protection point in each building. The IP Office expansion module and control unit and IROB devices must be connected to the protective ground point in their building.
DS Phone Extensions External expansion module DS ^[206] ports only.	ITWLinx towerMAX DS/2 ^[102] Supports up to 4 connections. (This device was previously referred to as the Avaya 146E).	<ul style="list-style-type: none"> The between building connection must be via earthed ducting, preferable underground. The cable must not be exposed externally at any point.
TCM Phone Extensions	None	Currently not supported.
Analog Trunks	ITWLinx towerMAX CO/4x4 ^[102] Supports up to 4 two-wire lines. (This device was previously referred to as the Avaya 146C).	<p>For installations in the Republic of South Africa, the fitting of surge protection on analog trunks is a requirement.</p> <p>For other locations where the risk of lightning strikes is felt to be high, additional protection of incoming analog trunks is recommended.</p>
External Output Switch	ITWLinx towerMAX SCL/8 (This device was previously referred to as the Avaya 146G)	Connections from an IP Office Ext O/P port to an external relay device must be via a surge protector.

The towerMAX range of devices are supplied by ITWLinx (<http://www.itwlinx.com>).

1.6 Wall and Rack Mounting

All the IP Office control units are designed to be free-standing. On systems with external expansion modules, the control unit and modules are intended to be stacked.

Using additional option mounting kits, some systems can be wall or rack mounted.

Control/Expansion Unit	Wall Mount	Rack Mount
IP500 Control Unit	✓	✓
IP500v2 Control Unit	✓	✓
IP500 External Expansion Modules	✓	✓
IP400 External Expansion Modules	–	✓

Wall Mounting

IP500, IP500v2 control units and IP500 external expansion modules can be wall mounted. To do this, a wall mounting kit is required in addition to suitable wall fixings. Wall mounting is not supported for IP400 external expansion modules.

In addition to the existing [environmental requirements](#) ^[38] for an IP Office system, the following additional requirements apply when wall mounting a unit:

- The wall surface must be vertical, flat and vibration free. Attachment to temporary walls is not supported.
- Only the screws provided with the mounting kit should be used to attach the brackets to the control unit.

The following wall mounting kits exist.

- IP500 Wall Mounting Kit V2 (*SAP Code 700500923*)
This kit can be used for wall mounting an IP500 or IP500 v2 control unit and IP500 external expansion modules. This kit incorporates cable routing at the front and rear of the unit. For control units it allows orientation of the control unit base card slots to the left or to the right.

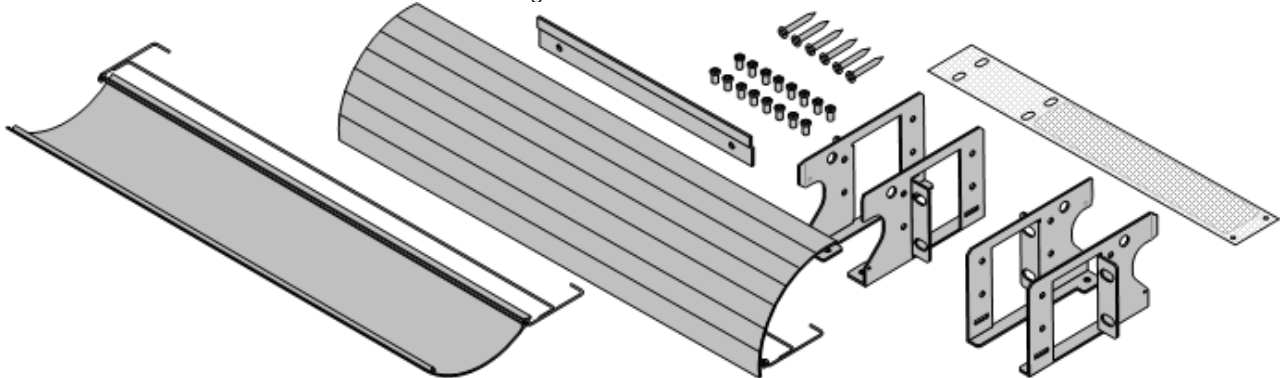

- IP500 Wall Mounting Kit (*SAP Code 700430150*)
This old design of wall mounting kit can be used for wall mounting an IP500 or IP500v2 control units only. It does not provide any cable routing and requires the control unit to be mounted with the base card slots to the right only.

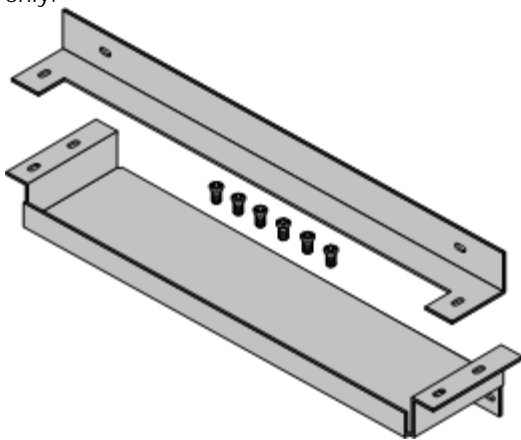

Rack Mounting

All IP Office control units and external expansion modules can be rack mounted into standard 19" rack systems. Each unit requires a 2U slot space within the rack. Rack mounting requires an IP400 or IP500 rack mounting kit for each control unit and external expansion module.

Where IP Office systems are being rack mounted, the effect of conditions within the rack cabinet must be considered. For example the rack temperature may be above the room temperature and airflow within the rack will be restricted. The [environmental requirements](#)^[38] for the individual IP Office units are still applicable inside the rack cabinet.

IP500 Rack Mounting Kit

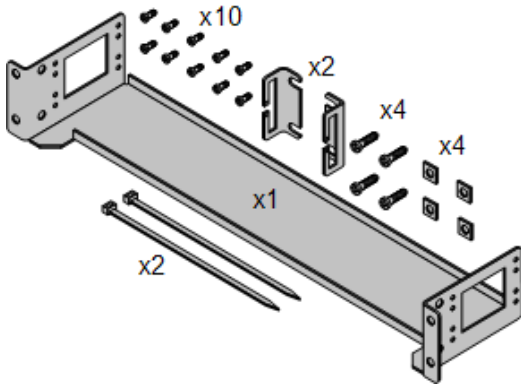

- IP500 Rack Mounting Kit (*SAP 700429202*)
This kit contains all the components required for the rack mounting of a single IP500v2 control unit, IP500 control unit or IP500 external expansion module. This includes screws for fixing of the brackets to the module, bolts for securing the module in the rack and cable tidy brackets.

IP400 Rack Mounting Kit

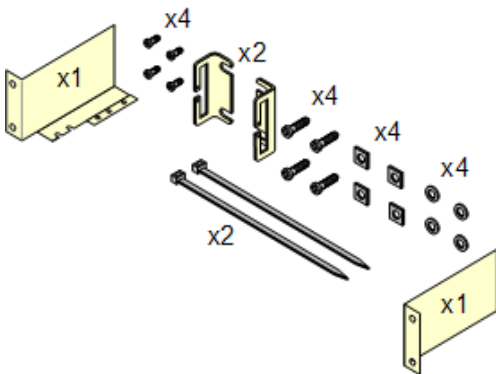

- IP400 Rack Mounting Kit (*SAP 700210800*)
This kit contains all the components required for the rack mounting of a single control unit or expansion module. This includes screws for fixing of the brackets to the module and bolts for securing the module in the rack.

Barrier Box Rack Mounting Kit

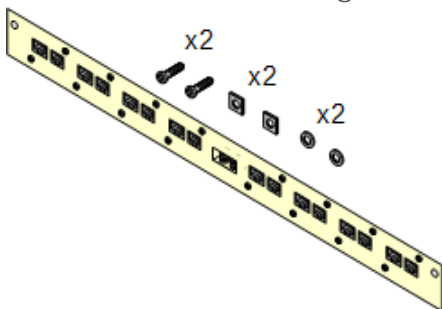

- Barrier Box Rack Mounting Kit (*SAP 700293905*)
Barrier boxes must be used for [out-of-building analog phone extensions](#)^[26]. This bracket allows up to 8 IP Office barrier boxes to be rack mounted and simplifies the number of connections to the protective ground point in the rack. This kit must be used when more than 3 barrier boxes are in use and supports a maximum of 16 barrier boxes for a single external expansion module.

1.7 Feature Keys and Licenses

A feature key is required for licensed features.



- [IP500v2 Avaya SD Card](#) ^[159]

Inserts into the System slot on the rear of an IP500v2 control unit. This card is required even if not using any IP Office licenses.

Various IP Office features and applications require entry of license keys into the system's configuration. The license keys are unique 32-character codes based on the feature being activated and the serial number of the [feature key dongle](#) ^[159] installed with the IP Office system.

The serial number is printed on the feature key dongle and prefixed with FK. It can also be viewed in the system configuration using IP Office Manager.

- For IP500v2 systems, the feature key dongle takes the form of an SD card inserted into the control unit. The card is a mandatory item for these systems even if they use no licensed features.

When a license key is entered into the IP Office configuration, the following information is shown.

- **Status**
The status, which is Unknown until the configuration file is sent back to the IP Office system.
 - *Unknown*
This status is shown for licenses that have just been added to the configuration shown in IP Office Manager. Once the configuration has been sent back to the IP Office and then reloaded, the status will change to one of those below.
 - *Valid*
The features licensed can be configured and used.
 - *Invalid*
The license was not recognized. It did not match the serial number of the Feature Key.
 - *Dormant*
The license is valid but is conditional on some other pre-requisite licenses.
 - *Obsolete*
The license is valid but is one no longer used by the level of software running on the IP Office system.
 - *Expired*
The license has gone past its expiry date.
- **License**
The name of the licensed feature. This may differ from the ordered RFA name.
- **Instances**
Depending on the license, this may be the number of ports enabled or number of simultaneous users of the licensed feature. Sometime the number of instances is specified in the license name.
- **Expires**
Most purchased licenses have no expiry setting. For some features, trial licenses may be available which will have an expiry date.

1.8 IP Office Phones

IP Office Release 7.0 supports the following phones and phone add-ons. Availability may depend on location and may be subject to local restrictions.

Enhanced Tip and Ring (ETR Port)

These phones are only supported on an ETR6 card in a IP500v2 systems. The following are supported in IP Office Essential Edition - Quick Version mode.

- ETR Series: [ETR6](#)^[171], [ETR6D](#)^[171], [ETR18](#)^[172], [ETR18D](#)^[172], [ETR34D](#)^[173] (*ETR 34D phones limited to a maximum of 2 per card and 4 in total*)
- PARTNER DECT: [3910](#)^[167], [3920](#)^[167]

Digital Station (DS Port)

These digital stations connect to the IP Office via [DS](#)^[206] ports. The following are supported in IP Office Essential Edition - Quick Version mode.

- 1400 Series: [1403](#)^[164], [1408](#)^[165], [1416](#)^[166]
- 9400 Series: [9404](#)^[168], [9408](#)^[168]
- 9500 Series: [9504](#)^[169], [9508](#)^[169]

Digital Station (TCM Port)

These digital stations connect to the IP500v2 IP Office system via [TCM](#)^[209] ports. The following are supported in IP Office Essential Edition - Quick Version mode.

- 4100 Series: 4135, 4136, 4145, 4145EX, 4146, 4146EX - Connection to IP Office TCM ports via a [Digital Mobility Solution](#)^[187] system.
- 7400 Series: 7420, 7430, 7434, 7439, 7440, 7444, 7449 - Connection to IP Office TCM ports via a [Digital Mobility Solution](#)^[187] system.
- ACU: [Audio Conferencing Unit](#)^[170]
- M-Series: [MT7100](#)^[174], [MT7100N](#)^[174], [MT7208](#)^[175], [MT7208N](#)^[175], [M7310](#)^[176], [M7310N](#)^[176], [M7324](#)^[177], [M7324N](#)^[177]
- T-Series: [T7000](#)^[178], [T7100](#)^[178], [T7208](#)^[179], [T7316](#)^[180], [T7316E](#)^[181], [T7406](#)^[182], [T7406E](#)^[182]

Analog Telephones

Analog phones and devices connect to [PHONE](#)^[208] ports with the IP Office system. However due to the variety of analog phones and device available no guarantee of operation is given. It is the responsibility of the IP Office installer and maintainer to test and verify the operation of proposed analog equipment.

- 6200 Series: 6211, 6219, 6221 (*North America*).
- Interquartz Gemini: 9330-AV, 9335-AV, 9281-AV (*Europe, Middle East, Africa, Asia-Pacific*).

1.9 SIP Trunks

The IP Office Essential Edition - Quick Version mode can support SIP trunks through its LAN connection. These are configured using IP Office Manager, they cannot be managed through phone based administration.

In order to support SIP trunks, the system must include the following resources:

- **SIP Trunk Licenses**
These licenses are used to configure the number of simultaneous SIP trunk calls supported, up to a maximum of 20. A IP Office Essential Edition - Quick Version mode system supports 3 channels without licenses.
- **Voice Compression Channels**
These are required to convert between the audio compression methods used for IP telephony and those used for analog and digital trunks. Each IP500 Combination card (up to 2) installed in the system provides 10 voice compression channels for the system. One voice compression channel is used for each SIP call.

1.10 Supported Country Locales

When a new or defaulted system's configuration is first opened in Manager, the value set in the Locale field should always be checked and changed if necessary. The system's Locale sets factors such as the default ringing patterns and caller display settings. The locale also controls the language that a voicemail server will use for prompts.

The locales supported in IP Office Essential Edition - Quick Version mode are:

- *Argentina*
- *Australia*
- *Bahrain*
- *Belgium*
- *Brazil*
- *Canada*
- *Chile*
- *China*
- *Colombia*
- *Denmark*
- *Egypt*
- *Finland*
- *France*
- *Germany*
- *Greece*
- *Hong Kong*
- *Hungary*
- *Iceland*
- *India*
- *Italy*
- *Korea*
- *Kuwait*
- *Mexico*
- *Morocco*
- *Netherlands*
- *New Zealand*
- *Norway*
- *Oman*
- *Pakistan*
- *Peru*
- *Poland*
- *Portugal*
- *Qatar*
- *Russia*
- *Saudi Arabia*
- *Singapore*
- *South Africa*
- *Spain*
- *Sweden*
- *Switzerland*
- *Taiwan*
- *Turkey*
- *United Arab Emirates*
- *United Kingdom*
- *United States*
- *Venezuela*

1.11 IP Office Software Applications

The IP Office applications are available on a number of DVDs. These can be ordered at a nominal cost to cover order processing and delivery. Separate installation packages for IP Office applications can also be downloaded from the Avaya support website at <http://support.avaya.com>.

Title	Discs	Description	SAP Code
IP Office Release 7.0 Admin and User DVD Set	2	<p>These DVDs contain installation packages for all the main IP Office administration and user applications. They also contain documentation for IP Office.</p> <ul style="list-style-type: none"> DVD 1: Contains the IP Office Administrator Applications suite, IP Office Documentation, IP Office User Applications, IP Office Voicemail Pro. DVD 2: Contains the Customer Call Reporter, ContactStore for IP Office and one-X Portal for IP Office applications. 	700500928

It is acceptable to make copies of the Avaya IP Office DVDs listed above. However the content must remain intact, unaltered and without change or addition. Avaya does not accept any liability and responsibility for damage or problems arising from the use of such copies.

Programming Applications

The following applications are used to program and maintain an IP Office system. Typically they run on a PC connected to the IP Office system via its LAN interface. These applications are all provided on the IP Office Administrator Applications DVD and don't require any licenses.

Due to the nature of the applications, if installed on a PC at the customer site, this should be a secure PC or the PC of a trusted user. If a voicemail server PC is also being installed with the IP Office system, the same PC can be used for the programming and maintenance applications.

For maintainers, these applications can also be run remotely if a route for data connections to the customer's IP Office exists from the maintainer's location.

- [IP Office Manager](#)^[188]
This tool is used to access all parts of the IP Office configuration. Different levels of access can be defined to control which parts of the configuration the Manager user can view and alter. Manager is also used to upgrade the software files used by an IP Office system.
- [System Status Application](#)^[190]
This application can be used to inspect the current status of IP Office lines and extensions and to view records of recent alarms and events. It runs as a Java application.
- [Monitor \(SysMon\)](#)^[189]
Monitor is a tool that can show a trace of all activity on the IP Office system in detail. As a consequence, interpretation of Monitor traces requires a high-level of data and telephony protocol knowledge. Despite that however, all IP Office installers and maintainers need to understand how to run Monitor when necessary as Avaya may request copies of Monitor traces to resolve support issues.

User Applications

For systems running in IP Office Essential Edition - Quick Version mode, the following is supported:

- [TAPILink Lite](#)⁽¹⁹⁾

The Microsoft Telephony Application Program Interface (TAPI) allows TAPI compliant applications to interact with IP Office phones by installing an IP Office TAPI driver. TAPILink Lite does not require any licenses entered into the IP Office system's configuration. It allows TAPI compliant applications such as Outlook to make and answer calls. The speech part of the calls is still via the user's physical phone.

Voicemail Applications

The IP Office supports a range of applications for the recording and playing of voicemail messages.

- Embedded Voicemail

This application is supported on all IP Office Release 6 systems. Embedded Voicemail supports basic voicemail mailbox operation, simple auto-attendants and hunt group announcements. For IP500 and IP500v2 controls units, embedded voicemail is provided by the Avaya SD card fitted by default.

Call Logging Applications

A wide range of 3rd -party applications exist to provide call logging and accounting for telephone systems. To support these the IP Office provides an SMDR output.

- SMDR Output

For IP Office Release 5.0 and higher, the IP Office control unit directly output SMDR records to a specified IP address.

1.12 Training

Avaya University provides a wide range of training courses for IP Office and its associated applications. This includes courses necessary for IP Office resellers to become Avaya Authorized Channel Partners and for individuals to achieve IP Office certification.

Details of courses can be found on the Avaya University web site (<http://www.avaya-learning.com>). The site can be used to check course availability and to book course. It also includes on-line courses and on-line course assessments. The site requires users to setup a user name and password in order to track their personal training record.

1.13 Web Sites

Information to support the IP Office can be found on a number of web sites.

- [Avaya](http://www.avaya.com) (<http://www.avaya.com>)
The official web site for Avaya. The front page also provides access to individual Avaya web sites for different countries.
- [Avaya Enterprise Portal](http://partner.avaya.com) (<http://partner.avaya.com>)
This is the official web site for all Avaya Business Partners. The site requires registration for a user name and password. Once accessed, the site portal can be individually customized for what products and information types you wish to see and to be notified about by email.
- [Avaya Support](http://support.avaya.com) (<http://support.avaya.com>)
Contains documentation and other support materials for Avaya products including IP Office. Copies of the IP Office CD images are available from this site and updated core software .bin files.
- [Avaya IP Office Knowledge Base](http://marketingtools.avaya.com/knowledgebase) (<http://marketingtools.avaya.com/knowledgebase>)
Access to an on-line regularly updated version of the IP Office Knowledge Base.
- [Avaya University](http://www.avaya-learning.com) (<http://www.avaya-learning.com>)
This site provides access to the full range of Avaya training courses. That includes both on-line courses, course assessments and access to details of classroom based courses. The site requires users to register in order to provide the user with access to details of their training record.
- [Avaya Community](http://www.aucommunity.com) (<http://www.aucommunity.com>)
This is the official discussion forum for Avaya product users. However it does not include any separate area for discussion of IP Office issues.
- Other Non-Avaya Web Sites
A number of third-party web forums exist that discuss IP Office. These can act as useful source of information about how the IP Office is used. Some of these forums require you to be a member and to register. These are not official Avaya forums and their content is not monitored or sanctioned by Avaya.
 - [Tek-Tips](http://www.tek-tips.com) (<http://www.tek-tips.com>)
 - [IP Office Info](http://www.ipofficeinfo.com) (<http://www.ipofficeinfo.com>)
 - [Yahoo Groups](http://groups.yahoo.com/group/ipoffice) (<http://groups.yahoo.com/group/ipoffice>)
 - [PBX Tech](http://www.pbxtech.info/forumdisplay.php?f=8) (<http://www.pbxtech.info/forumdisplay.php?f=8>)

1.14 Emergency and Power Failure Ports

IP Office systems can provide 2 types of analog extension power failure ports. These are:

Type	Description	Provided By:
Switching Power Failure Ports	<p>During normal IP Office operation these ports can be used for normal analog phone connection.</p> <p>During power failure the port is directly connected to an analog trunk port.</p>	<ul style="list-style-type: none"> IP500 Analog Phone 8 Card When an IP500 Analog Phone 8 base card is fitted with an IP500 Analog Trunk daughter card, during power failure extension port 8 is connected to analog trunk port 12. IP500 ATM Combination Card On this card, during power failure, extension port 8 is connected to analog trunk port 12.
Emergency Only Power Failure Ports	<p>During normal IP Office operation these ports cannot be used.</p> <p>During power failure the port is directly connected to an analog trunk port.</p>	<ul style="list-style-type: none"> IP500 Analog Trunk Daughter Card Regardless of the IP500 card hosting it, during power failure pins 4 and 5 of port 12 are connected to pins 7 and 8. IP400 ATM16 External Expansion Module This external expansion module has two ports, PF1 and PF2, on its rear. During power fail conditions, PF1 is internally connected to ANALOG port 1 on the module, PF2 is internally connected to ANALOG port 2 on the same module. IP500 ETR6 Card On this card, during normal operation extension ports 7 and 8 are not useable. However, if the card is fitted with an IP500 Analog Trunk daughter card, during power failure extension ports 7 and 8 are connected to analog trunk port 12.

In all cases these only work with loop-start analog trunks. Any phones connected to these ports should be clearly labeled as power fail extensions in accordance with the appropriate national and local regulatory requirements.

Chapter 2.

Installation Requirements

2. Installation Requirements

2.1 Environmental Requirements

The planned location must meet the following requirements. If being installed into a rack system, these are requirements for within the rack:

1. Temperature: 0°C to 40°C / 32°F to 104°F.
2. Humidity: 10% to 95% non-condensing.
3. Check there are no flammable materials in the area.
4. Check there is no possibility of flooding.
5. Check that no other machinery or equipment needs to be moved first.
6. Check that it is not an excessively dusty atmosphere.
7. Check that the area is unlikely to suffer rapid changes in temperature and humidity.
8. Check for the proximity of strong magnetic fields, sources of radio frequency and other electrical interference.
9. Check there are no corrosive chemicals or gasses.
10. Check there is no excessive vibration or potential of excessive vibration, especially of any mounting surface.
11. Check that where telephones are installed in another building, that the appropriate protectors and protective grounds are fitted (see [Out of Building Telephone Installation](#)^[26]).
12. Check there is suitable lighting for installation, system programming and future maintenance.
13. Check that there is sufficient working space for installation and future maintenance.
14. Ensure that likely activities near the system will not cause any problems, e.g. access to and maintenance of any other equipment in the area.
15. Where ventilation holes are present on any of the IP Office units, those holes should not be covered or blocked.
16. The surface must be flat horizontal for free-standing or rack mounted installations.

Wall Mounting

In addition to the requirements above, the following are applicable to IP Office units that support wall mounting.

1. Units must only be mounted onto permanent wall surfaces.
2. The surface must be vertical and flat.
3. Orientation of the unit must be as shown in the section on [IP500 Wall Mounting](#)^[65].
4. The appropriate Avaya wall mounting kits must be used.

IMPORTANT SAFETY INSTRUCTIONS

When using your telephone equipment, basic safety precautions should always be followed to reduce the risk of fire, electric shock and injury to persons, including the following:

1. Do not use this product near water, for example, near a bath tub, wash bowl, kitchen sink or laundry tub, in a wet basement or near a swimming pool.
2. Avoid using a telephone (other than a cordless type) during an electrical storm. There may be a remote risk of electric shock from lightning.
3. Do not use the telephone to report a gas leak in the vicinity of the leak.
4. Use only the power cord and batteries indicated in this manual.

2.2 Space Requirements

IP Office control units and modules are designed to be installed either in a free-standing stack or into a 19" rack system. Rack installation requires a [rack mounting kit](#)²⁷ for each control unit and expansion module.

- **Cable Clearance**
Clearance must be provided at the front and rear of all modules for cable access and feature key dongle connection.
 - On IP400 systems, allow a minimum clearance of 75mm (3 inches).
 - On IP500 and IP500v2 systems allow a minimum clearance of 90mm (3.5 inches).
- **Additional Clearance**
Care should be taken to ensure that the positioning of the modules does not interrupt air flow and other factors that may affect [environmental requirements](#)³⁸. This is especially important on IP500 and IP500v2 control units which have ventilation slots at the side.
- **Cable Access**
Power cords must not be attached to the building surface or run through walls, ceilings, floors and similar openings. Installation measures must be taken to prevent physical damage to the power supply cord, including proper routing of the power supply cord and provision of a socket outlet near the fixed equipment or positioning of the equipment near a socket outlet.

2.2.1 IP500 and IP500v2 Control Units

The ventilation slots on the rear and sides should not be covered or blocked.

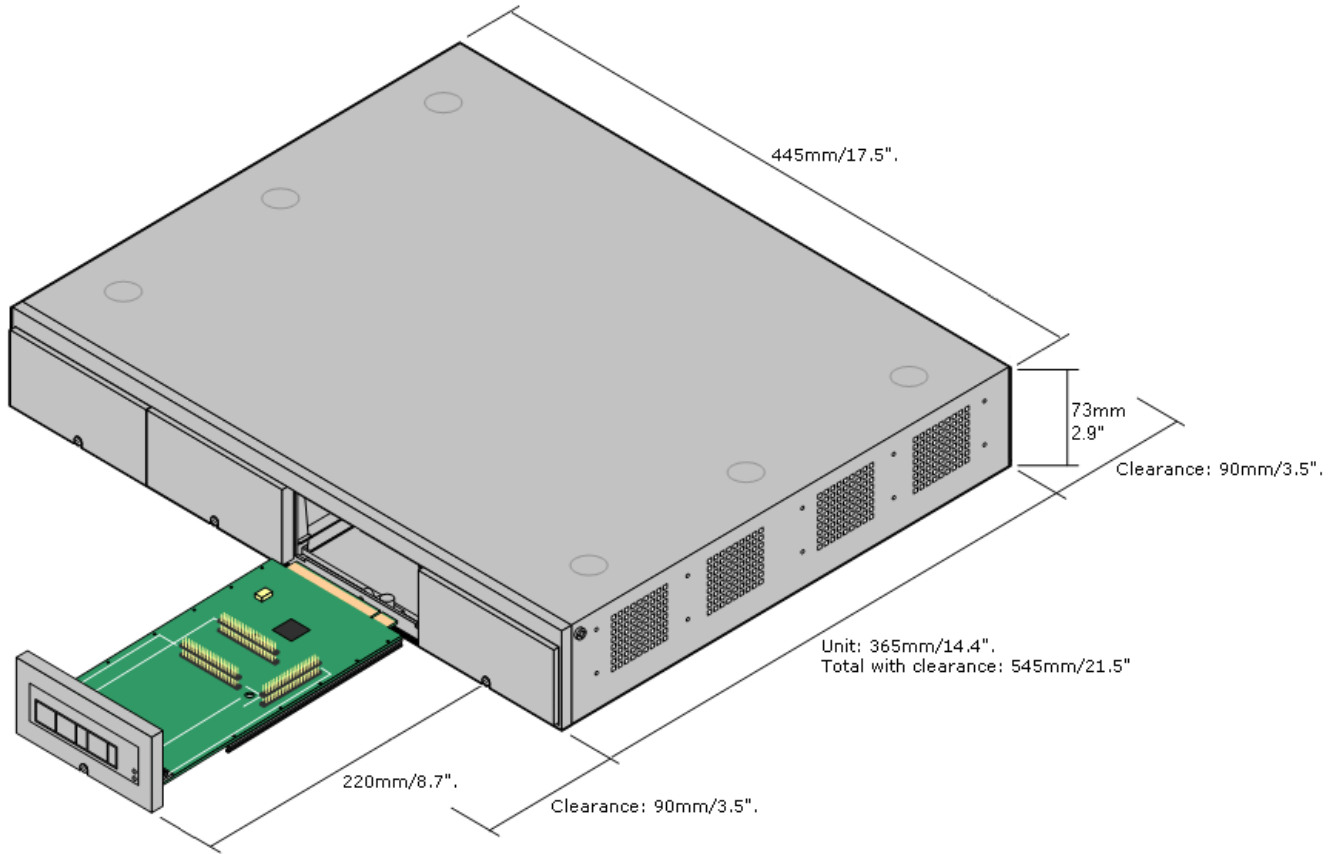

2.2.2 External Expansion Modules

The dimensions below are applicable to all IP Office external expansion modules.

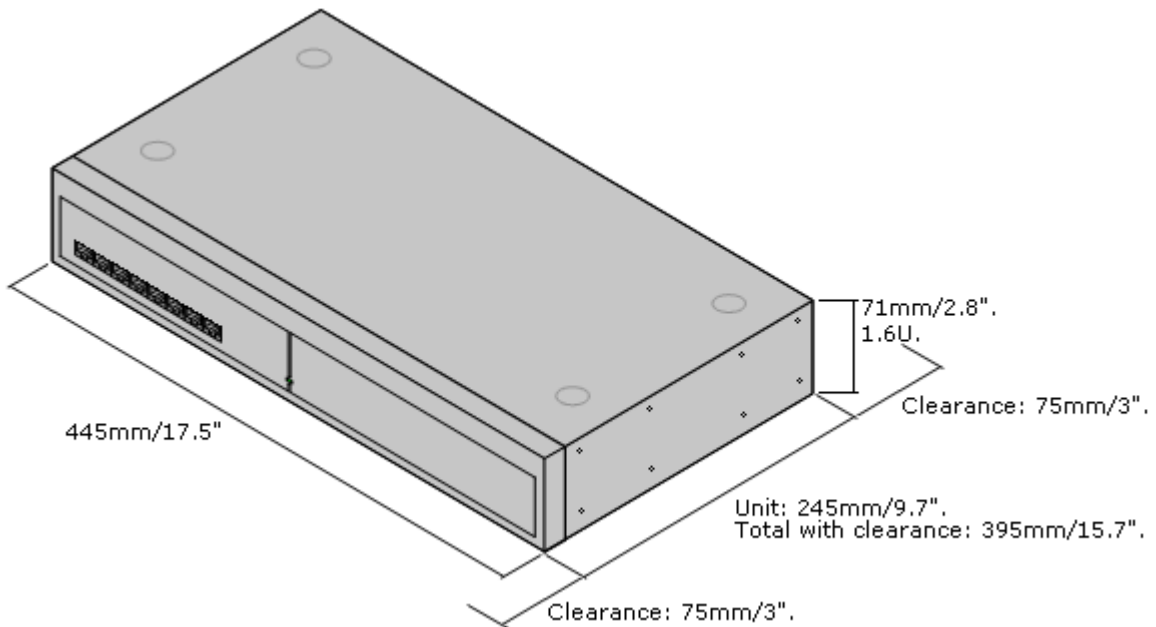

2.2.3 Wall Mounting

IP500, IP500v2 control units and IP500 external expansion modules can be wall mounted. To do this, a wall mounting kit is required in addition to suitable wall fixings. Wall mounting is not supported for IP400 external expansion modules.

In addition to the existing [environmental requirements](#) ³⁸ for an IP Office system, the following additional requirements apply when wall mounting a unit:

- The wall surface must be vertical, flat and vibration free. Attachment to temporary walls is not supported.
- Only the screws provided with the mounting kit should be used to attach the brackets to the control unit.

The following wall mounting kits exist.

- IP500 Wall Mounting Kit V2 (*SAP Code 700500923*)
This kit can be used for wall mounting an IP500 or IP500 v2 control unit and IP500 external expansion modules. This kit incorporates cable routing at the front and rear of the unit. For control units it allows orientation of the control unit base card slots to the left or to the right.

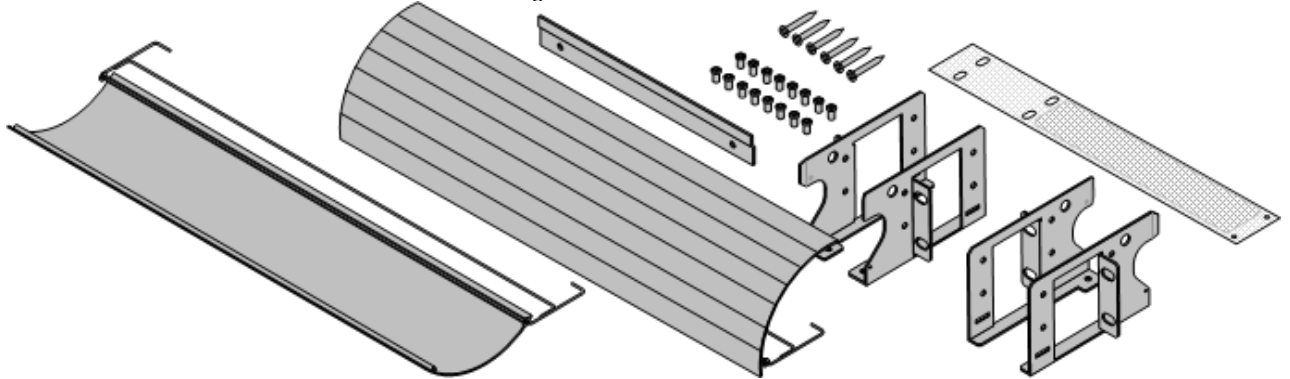

- IP500 Wall Mounting Kit (*SAP Code 700430150*)
This old design of wall mounting kit can be used for wall mounting an IP500 or IP500v2 control units only. It does not provide any cable routing and requires the control unit to be mounted with the base card slots to the right only.

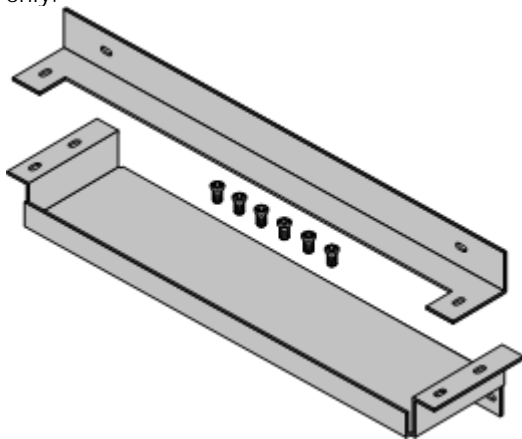

Wall Mounting Kit V2

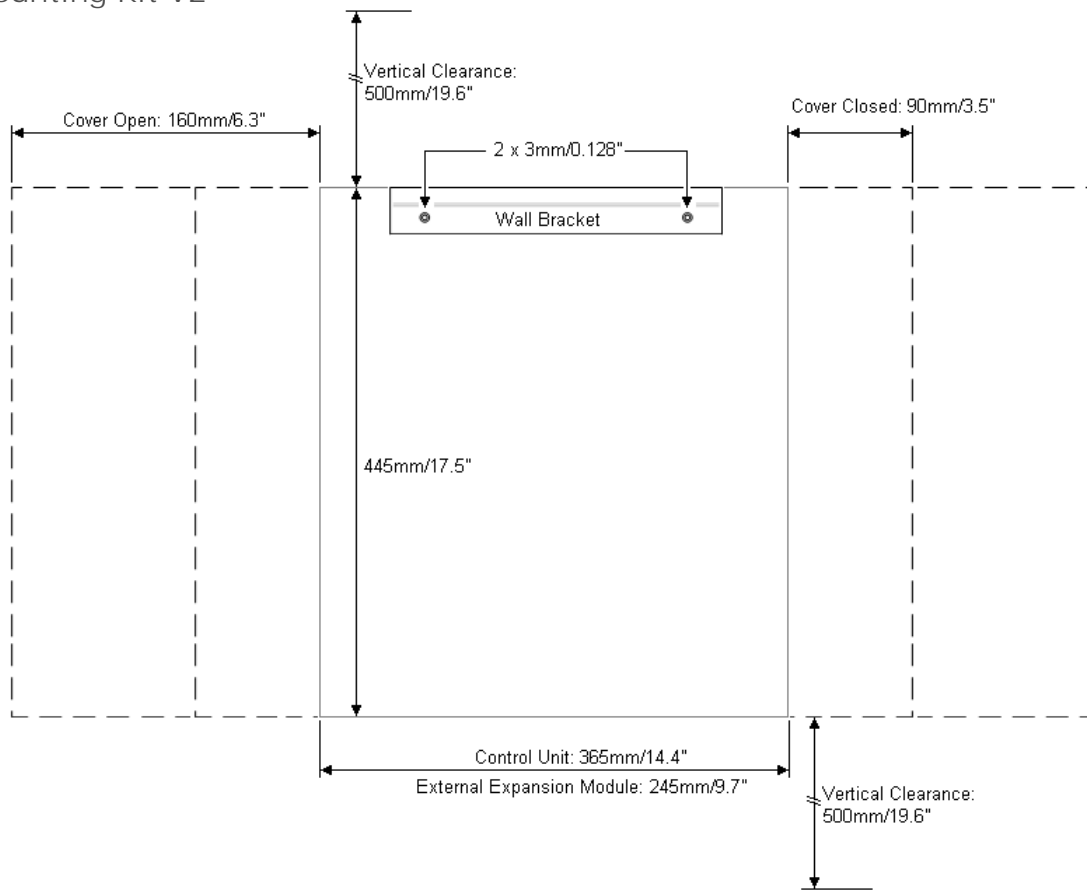

Wall Mounting Kit V1

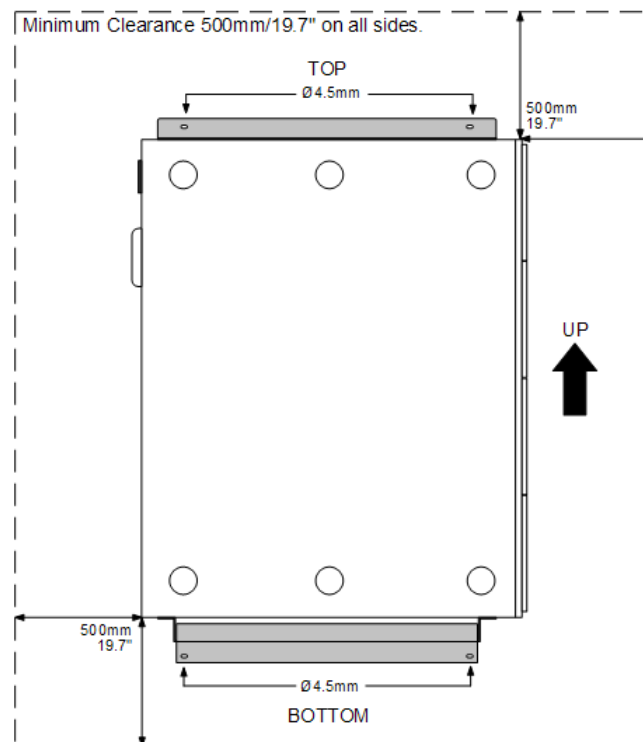

2.2.4 Rack Space Requirements

All IP Office control units and external expansion modules can be rack mounted into standard 19" rack systems. Each unit requires a 2U slot space within the rack. Rack mounting requires an IP400 or IP500 rack mounting kit for each control unit and external expansion module.

Where IP Office systems are being rack mounted, the effect of conditions within the rack cabinet must be considered. For example the rack temperature may be above the room temperature and airflow within the rack will be restricted. The [environmental requirements](#)^[38] for the individual IP Office units are still applicable inside the rack cabinet.

IP500 Rack Mounting Kit

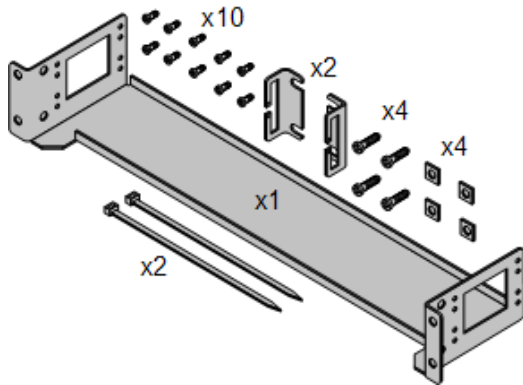

- IP500 Rack Mounting Kit (*SAP 700429202*)
This kit contains all the components required for the rack mounting of a single IP500v2 control unit, IP500 control unit or IP500 external expansion module. This includes screws for fixing of the brackets to the module, bolts for securing the module in the rack and cable tidy brackets.

IP400 Rack Mounting Kit

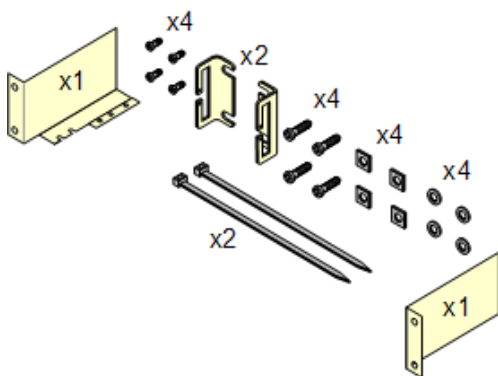

- IP400 Rack Mounting Kit (*SAP 700210800*)
This kit contains all the components required for the rack mounting of a single control unit or expansion module. This includes screws for fixing of the brackets to the module and bolts for securing the module in the rack.

Barrier Box Rack Mounting Kit

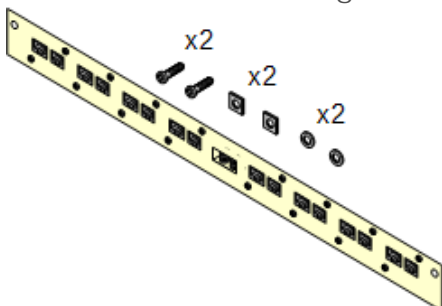

- Barrier Box Rack Mounting Kit (*SAP 700293905*)
Barrier boxes must be used for [out-of-building analog phone extensions](#)^[28]. This bracket allows up to 8 IP Office barrier boxes to be rack mounted and simplifies the number of connections to the protective ground point in the rack. This kit must be used when more than 3 barrier boxes are in use and supports a maximum of 16 barrier boxes for a single external expansion module.

Chapter 3.

IP Office Administration Software

3. IP Office Administration Software

In order to install an IP Office system you must be familiar with using the following IP Office applications. They must be available on your installation PC.



- **Manager**

IP Office Manager is used to access all parts of the IP Office configuration. Different levels of access can be defined to control which parts of the configuration Manager user can view and alter. Manager is also used to upgrade the software files used by an IP Office system.



- **System Status**

The IP Office System Status application (SSA) is a reporting tool that provides a wide range of information about the current status of an IP Office system. It can report the available resources and components within the system and details of calls in progress. Details of the number of alarms are recorded and the time/date of the most recent alarms. When required for diagnostics escalation, SSA is able to take a snap shot image of the IP Office system's status including a copy of its current configuration. Use of SSA requires an IP Office service user name and password that has been configured for System Status access in the IP Office's security settings.



- **Monitor**

IP Office Monitor (also known as System Monitor) is a tool that can show all activity on the IP Office system in great detail. As a consequence, interpretation of Monitor traces requires a high-level of data and telephony protocol knowledge. However, all IP Office installers and maintainers must understand how to run Monitor when necessary as Avaya may request copies of Monitor traces to resolve support issues.

- **Phone Based Administration**

For systems running in IP Office Essential Edition - Quick Version mode, many features can be administered using phone based administration from either of the first two extensions in the system.

3.1 Installing the Admin Applications



The IP Office Administration suite consists of a number of applications for IP Office installers and maintainers.

- System Monitor - *Install* ✓
- Manager - *Install* ✓
- System Status Application - *Install* ✓
- Call Status - *Optional*

This software is not supported with IP Office Release 7.0 systems. It is provided only for the maintenance of older systems.

Requirements

- IP Office Release 7.0 User/Admin DVD Set (2) (700500928)
Alternatively the IP Office Administrator Applications suite can be downloaded from [Avaya's support website](http://support.avaya.com/) (<http://support.avaya.com/>).
- Windows PC Requirements
This should meet the requirements of the administrator applications being installed. The specification below are the minimum requirements for IP Office Manager. If other applications are to be installed on the PC then their individual requirements should also be met.

Requirement	Minimum	Recommended
Processor	600MHz Pentium or AMD Opteron, AMD Athlon64, AMD Athlon XP.	800MHz Pentium or AMD Opteron, AMD Athlon64, AMD Athlon XP.
RAM	128MB	256MB
HD Space	1GB - 800MB for .NET2, 200MB for Manager.	1.4GB - 800MB for .NET2, 600MB for the full IP Office Admin suite.
Display	800 x 600 - 256 Colors	1024 x 768 - 16-bit High Color
Operating System	Supported on Windows XP Pro, Windows Vista, Windows 7, Windows 2003 and Windows 2008. <ul style="list-style-type: none"> • 32-bit and 64-bit versions are supported. • Vista support is only on Business, Enterprise and Ultimate versions. • Windows 7 support is only on Professional, Enterprise and Ultimate versions. 	

Installing the IP Office Admin Applications

- Using the Add or Remove Programs option in the Windows Control Panel, check that the PC does not already have a version of the IP Office Admin suite installed.
 - If 'yes' and the suite is a pre-IP Office 3.2 version, remove the existing IP Office Admin suite via Add/Remove Programs.
 - If the existing suite is IP Office 3.2 or higher, it is possible to upgrade without removing the previous installation. However, if the system already has a USB Feature Key, the key should be removed prior to upgrading and then reinserted and the PC restarted.
- Insert the IP Office Administrator Applications DVD. Select the option for the IP Office Administration Suit. A folder window will display the installation files for the administration suite.
- Double-click on setup.exe.
- Select the language you want to use for the installation process. This does not affect the language used by Manager when running. Click Next >.
- Select who should be able to run the Admin Suite applications. Click Next >.
- If required select the destination to which the applications should be installed. We recommend that you accept the default destination. Click Next >.
- The next screen is used to select which applications in the suite should be installed. Clicking on each will display a description of the application. Click on the ▼ next to each application to change the installation selection. When you have selected the installations required, click Next >.

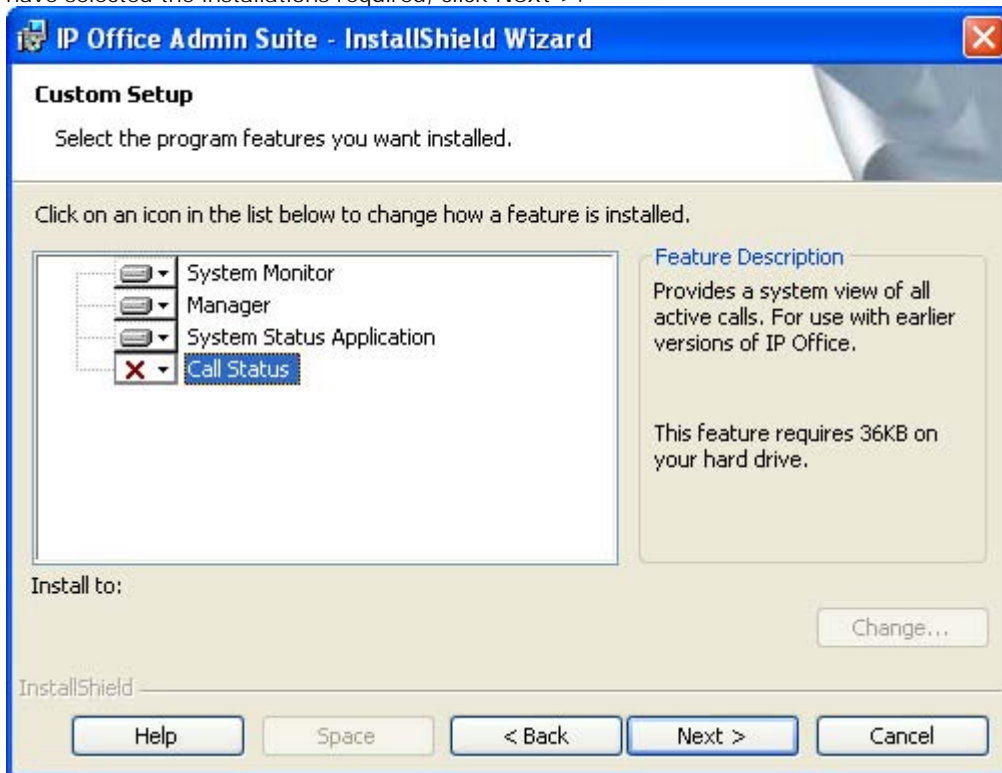

- Ensure that at minimum System Monitor and Manager are selected. Click Next >.
- Click I nstall.
- Installation of Windows .Net2 components may be required. If dialogs for this appear, follow the prompts to install .Net.
- If requested, reboot the PC.

3.2 Installer PC Connection

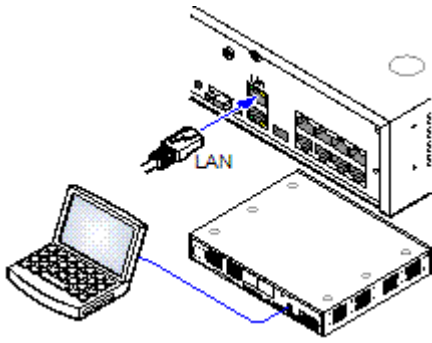

During installation it is recommended that the IP Office control unit is started without it being connected to any network. That ensure that the IP Office defaults to a known set of IP address settings.

If the IP Office is started connected to a network with a DHCP server. The programming PC will need to be connected to the same network as either a DHCP client or with an IP address valid for that network.

This section covers connecting your installation PC directly to the IP Office control unit.

Requirements

- IP Office Administration PC
A Windows PC with the [IP Office Administrator Application suite installed](#) [47].
- LAN Cable

Direct Connection to a Defaulted IP Office Control Unit

1. The default address for an IP Office control unit LAN port is 192.168.42.1/255.255.255.0. To directly connect a PC, change the TCP/IP properties for the PCs LAN port to the following:

Fixed IP address	192.168.42.203
Subnet mask	255.255.255.0
Default gateway	192.168.42.1.

- While setting the PC to be a DHCP client could be used, this is not recommended for performing more advanced functions such as firmware upgrades.
2. Connect the LAN cable from the PCs LAN port the LAN or LAN1 port on the IP Office control unit.
 3. Check that the orange LED lamp on the IP Office LAN port is on. The green LED may also be flickering as it indicates traffic across the LAN connection.
 4. To test the connection before running Manager or System Status Application:
 - Select Start | Run and enter *cmd*.
 - In the command window that appears enter ping 192.168.42.1. The results should show a number of ping replies from the IP Office. This confirms basic communication between the Manager PC and the IP Office.
 - If there are no ping replies enter ipconfig. The results should list the IP address settings of the Manager PC as required above. If they do enter exit and check the cable connection.
 5. You can now start [Manager](#) [50], [System Status](#) [51] or [System Monitor](#) [52].

3.3 Starting Manager

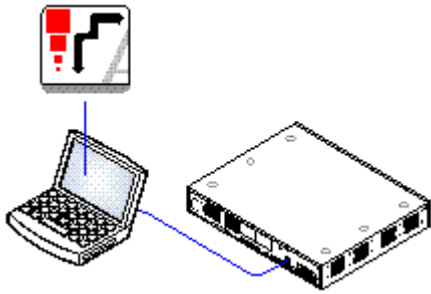

IP Office Manager is used to access all parts of the IP Office configuration. Manager can also be used to upgrade the software files used by an IP Office system.

Requirements

- IP Office Administration PC
A Windows PC with the [IP Office Administrator Application suite installed](#)
- LAN Cable

1. Select Start | Programs | IP Office | Manager.
2. If the PC has firewall software installed, you may be prompted as to whether you want to allow this program to access the network. Select Yes or OK.
3. Select File | Open Configuration from the menu bar.
4. The Select IP Office window appears. After a few seconds it should list the IP Office control unit. The default name used for a newly installed IP Office control unit is its MAC address.

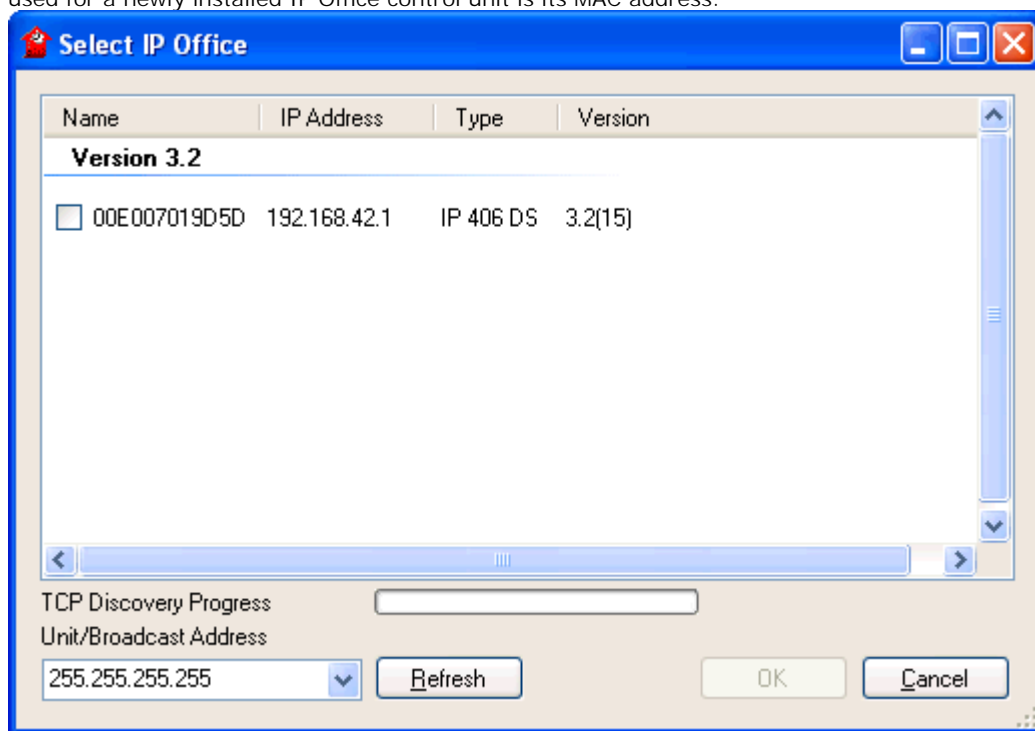

- If the system required was not found, the address used for the search can be changed. Enter or select the required address in the Unit/Broadcast Address field and then click Refresh to perform a new search.
5. Click the check the box next to the system and then click OK.
 6. The name and password request is displayed. The name and password must match one of those setup through the security settings. For a IP Office Essential Edition - Quick Version mode system, the default name and password for configuration access are *Administrator* and *password*.

3.4 Starting System Status

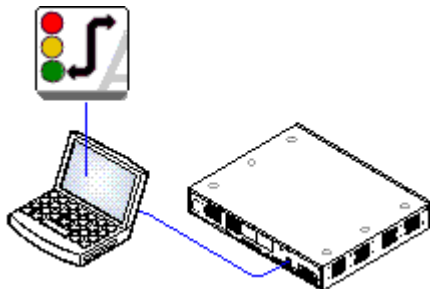

The IP Office System Status application (SSA) is a reporting tool that provides a wide range of information about the current status of an IP Office system. Its can report the available resources and components within the system and details of calls in progress. Details of the number of alarms are recorded and the time date of the most recent alarms.

When required for diagnostics escalation, SSA is able to take a snap shot image of the IP Office system's status including a copy of its current configuration. Use of SSA requires an IP Office service user name and password that has been configured for System Status access in the IP Office's security settings.

Requirements

- IP Office Administration PC
A Windows PC with the [IP Office Administrator Application suite installed](#)
- LAN Cable

1. There are several methods that can be used to start the IP Office System Status application.

- On a PC where System Status has been installed, select Start | Programs | IP Office | System Status.
- If Manager is also installed and is running, select File | Advanced | System Status.
- For IP500v2 controls units, start a web browse and enter the IP address of the control unit. Select the link for the System Status Application.

2. Once System Status has started, it will request the details of the IP Office system to which you want it to connect.

- Control Unit IP Address
Enter the IP address of the IP Office control units LAN interface or use the drop down to select a previously used address..
- Local IP Address
If the PC has more than one IP address assigned to its network card or multiple network cards, the address to use can be selected if necessary.
- User Name/Password
Enter the same user name and password as used for IP Office Manager.
- Auto Reconnect
If selected, System Status will attempt to reconnect using the same settings if connection to the IP Office is lost.

3. Enter the required details for the IP Office and click Logon.

3.5 Starting Monitor

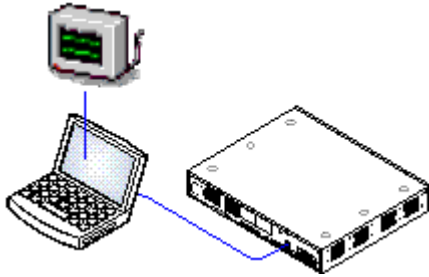

IP Office Monitor (also known as System Monitor) is a tool that can show all activity on the IP Office system in great detail. As a consequence, interpretation of Monitor traces requires a high-level of data and telephony protocol knowledge. However, all IP Office installers and maintainers must understand how to run Monitor when necessary as Avaya may request copies of Monitor traces to resolve support issues.

Requirements

- IP Office Administration PC
A Windows PC with the [IP Office Administrator Application suite installed](#)
- LAN Cable

1. Select Start | Programs | IP Office | Monitor.
2. If System Monitor has been run before it will attempt to connect with the system which it monitored previously. If otherwise or you want to monitor a different system use the steps below.
3. Select File | Select Unit.

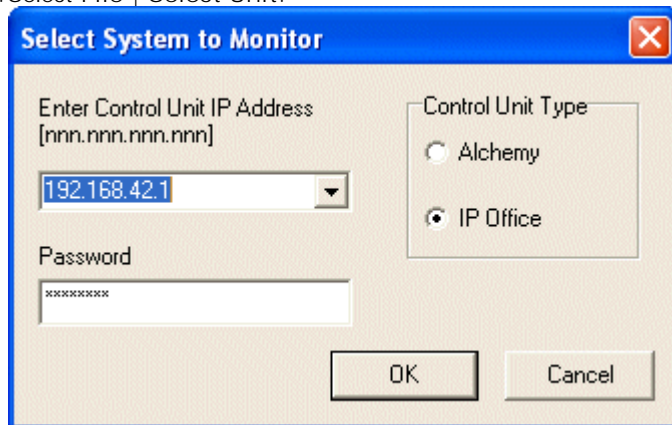

4. Enter the IP Office IP address and password of the IP Office Control Unit you want to monitor.
 - For an IP Office system, ensure that the Control Unit Type is set to IP Office.
5. Click OK.

3.6 Phone Based Administration

For systems running in IP Office Essential Edition - Quick Version mode, many features can be administered using phone based administration.

Some settings cannot be changed through phone based administration; for example IP address and SIP trunk settings. Those settings are only used in conjunction with network systems for which it is assumed that IP Office Manager will be used for system configuration.

Phone based administration is only possible using either of the first two extension in the system. The phone connected at those positions also needs to be capable of being used for phone based admin.

- Supported phones are: ETR 18D, ETR 34D, M7310, M7310N, M7324, M7324N, T7316E, T7316, 1408 and 1416 phones.
- The card fitted into Slot 1 of the control unit must be the correct type to support the phones.
- For details, refer to the IP Office Essential Edition - Quick Version Phone Based Administration manual.

Chapter 4.

IP500v2 Installation

4. IP500v2 Installation

This installation process is a simple outline as installation requirements and processes will vary.

- In this process, all the IP Office hardware components are installed and connected without being switched on until the end of the process. The control unit will then upgrade all the connected components, including phones, to the appropriate level of firmware.
- Also when switched on, the system is not connected to the customers data network. This ensures that the control unit will default to known default IP address settings (unless you have pre-loaded the System SD card with a configuration file with different settings).
- [Tools and Parts Required](#) ^[55]
Check that you have the tools and additional parts required.
- [Documentation](#) ^[56]
Ensure that you have obtained and read all the relevant documentation.
- [Unpacking](#) ^[57]
Check that all the required equipment has been delivered and that there is no damage.
- [SD Card Preparation](#) ^[58]
Upgrade and pre-load the System SD card with a configuration and other files in order to speed up installation.
- [Install the Base Cards](#) ^[62]
Attach any trunk daughter cards to the IP500 base cards. Insert the cards into the control unit.
- [Wall Mounting](#) ^[65]
If wall mounting, attach the brackets and fit the unit to the wall.
- [Rack Mounting](#) ^[69]
If rack mounting, attach the brackets and fit the control unit into the rack.
- [Connect External Expansion Modules](#) ^[71]
Connect the external expansions modules to the control unit.
- [Grounding](#) ^[73]
Attach required ground cables to the control unit and external expansion modules.
- [LAN Network Connections](#) ^[74]
Attach the IP Office control unit and a PC with IP Office Manager to the LAN network.
- [Starting the System](#) ^[75]
Insert the System SD card and power up the system.
- [Changing the System to IP Office Standard Version Mode](#) ^[77]
IP500v2 systems installed in IP Office Essential Edition - Quick Version mode can be changed to operate in IP Office Standard Version mode.
- [Connecting Phones](#) ^[78]
Connect the Avaya digital phones.

4.1 Tools and Equipment Required



The following is a general summary of the tools required. Additional tools and equipment will be required for wall and or rack mounting and to fashion ground cable connections suitable to local requirements.

- Tools Required

- 5mm Flat-blade screwdriver.
- Crosshead screwdriver.
- Anti-static wrist strap and ground point.
- RJ45-RJ45 Ethernet LAN Cable.
- M4 Cross-Head Screwdriver.
- Tools suitable for crimping a cable spade.
- If wall mounting, drills and tools for wall mounting fixtures.

- Additional Parts Required

In addition to orderable IP Office equipment, the following items will be required.

- 14AWG Solid copper wire for ground connection of control units and expansion modules.
- Cable sleeve matching local regulator requirements for ground wires. Typically green for a functional ground and green/yellow for a protective ground.
- If wall mounting, additional fixtures and fittings suitable for the wall type and mounting kit being used.
- Cable ties and labels for tidying and identifying cables.

- PC Requirements



IP Office Essential Edition - PARTNER® Version IP Office Essential Edition - Norstar Version IP Office Essential Edition - Quick Version

1. [Windows PC with IP Office Admin suite installed](#)^[47] and RJ45 Ethernet LAN port.
2. SD Card reader.

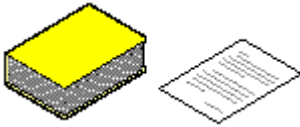
4.2 Documentation



Ensure that you have read this manual in full before starting installation. Also include the installation documentation for any other equipment and applications being installed as part of the IP Office system.

-  IP Office Technical Bulletins
Ensure that you have obtained and read the IP Office Technical Bulletin relating to the IP Office software release which you are installing. This bulletin will contain important information that may not have been included in this manual. IP Office Technical Bulletins are available from the [Avaya support](http://support.avaya.com) website (<http://support.avaya.com>).
-  Upgrade Licenses
Some upgrades may require entry of upgrade licenses.

- *IP Office Product Description*
Covers the features provided by IP Office 7.0 - IP Office Essential Edition - Quick Version.
- *IP Office Essential Edition - Quick Version Installation Manual*
Covers the equipment supported and the installation of that equipment.
- *IP Office Essential Edition - Quick Version Manager*
Covers the system programming that can be performed using the IP Office Manager application.
- *IP Office Essential Edition - Quick Version Phone Based Administration Manual*
Covers the range of system programming that can be performed from the first two extensions in the system.

Information Web Sites

IP Office documentation is available from the following web sites.

- [Avaya Support](http://support.avaya.com) (<http://support.avaya.com>)
Contains documentation and other support materials for Avaya products including IP Office. Copies of the IP Office CD images are available from this site and updated core software .bin files.
- [Avaya IP Office Knowledge Base](http://marketingtools.avaya.com/knowledgebase) (<http://marketingtools.avaya.com/knowledgebase>)
Access to an on-line regularly updated version of the IP Office Knowledge Base.

4.3 Unpacking

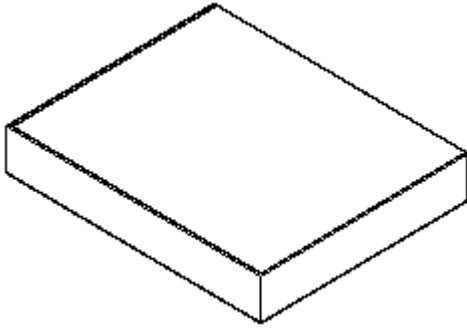

Use the following procedure when unpacking any equipment supplied by Avaya or an Avaya reseller or distributor.

Information Required

- Equipment Checklist.
An installation checklist of the parts and equipment ordered for the installation.

Procedure

1. Check for Packaging Damage
Before unpacking any equipment, check for any signs of damage that may have occurred during transit. If any damage exists bring it to the attention of the carrier.
2. Check the Correct Parts Have Been Delivered
Check all cartons against the packing slip and ensure that you have the correct items. Report any errors or omissions to the equipment supplier.
3. Retain All Packaging and Documentation
While unpacking the equipment, retain all the packaging material. Fault returns are accepted only if repackaged in the original packaging. If performing a staged installation, the original packaging will also assist when repacking equipment to be moved to the final install site.
4. Ensure that Anti-Static Protection Measures are Observed
Ensure that anti-static protection measures are observed at all times when handling equipment with exposed electrical circuit boards.
5. Check All Parts
Visually inspect each item and check that all the necessary documentation and accessory items have been included. Report any errors or omissions to the dealer who supplied the equipment.
6. Check All Documentation
Ensure that you read and retain any documentation included with the equipment.

4.4 SD Card Preparation

IP500v2 control units are supplied with no installed firmware or configuration. When first powered up, the control unit will load and install the necessary firmware from the System SD card installed in it. It will then create a default configuration matching the cards installed in the control unit and external expansion modules attached to it.

You can perform a number of additional actions prior to installing the System SD card in order to pre configure the IP Office system.

- [Upgrade the Card Firmware](#) ⁵⁸
- [Add a Configuration File](#) ⁵⁸
- [Add a License File](#) ⁶¹
- [Add Music on Hold Files](#) ⁶¹

Additional actions that can be performed on SD cards are detailed in the [SD Card Management](#) ¹¹⁴ section.

4.4.1 Upgrade the Card Firmware

This command can be used with a read-writeable SD card on the Manager PC. It copies the files and folders used by an IP500v2 system when starting. It updates the card with the version of those files installed with the IP Office Manager application. It includes the binary files for the IP500v2 system, external expansion modules and phones. It also includes the prompt files for embedded voicemail operation.

This process just replaces existing files and adds new files. It does not delete files, so for example, any existing embedded voicemail messages and greetings are retained. If the card contains dynamic system files such as SMDR records, they are temporarily backed up by Manager and then restored after the card is recreated.

For the card to be used in an IP500v2 system's System SD slot the card must be Avaya SD Feature Key card. The card must be correctly formatted, however a reformat of an existing working card is not necessary before using recreate to update the card contents.

- The source for the files copied to the SD card are the sub-folders of the *Memory Cards* folder under Manager's Working Directory (normally *C:\Program Files Avaya\IP Office\Manager*). However, if the Working Directory is changed to a location without an appropriate set of *Memory Cards* sub-folders, the required set of files will not be copied onto the SD card.
1. Once started do not interrupt this process, for example by removing the SD card. This process takes approximately 15 minutes.
 2. Insert the SD card into a card reader on the Manager PC.
 3. Using IP Office Manager, select File | Advanced | Recreate IP Office SD Card.
 4. Select IP Office A-Law, IP Office U-Law or IP Office Partner Version. This selection will affect how the IP Office systems operates when defaulted with this card present in its System SD card slot. .
 5. Browse to the card location and click OK.
 6. Manager will start creating folders on the SD card and copying the required files into those folders. This process will take approximately 15 minutes.
 7. Do not remove the SD card during the process. Wait until the Manager displays a message.



4.4.2 Adding a Pre-Built Configuration File

IP Office Manager can be used to [create an IP Office configuration file](#) ⁶⁰. For IP500v2 control units, such a pre-created IP Office configuration file can be placed on the System SD card. That file will then be used when the IP Office system is started.

1. Using IP Office, create an offline configuration that matches the customer requirements and the equipment that will be installed in the IP Office.

2. Rename the configuration file *config.cfg*.
3. Using a card reader, copy the file into the */system/primary* folder on the System SD memory card.

4.4.3 Creating a Configuration File

IP Office Manager can be used to create a new configuration without connecting to an IP Office system. During the process, you can specify the locale of the system, what type of trunk cards it uses and what type of control unit and expansion modules to include.

This allows the creation of a configuration prior to installation of system. The configuration file can be [placed onto the System SD card](#) before it is installed into the system. Otherwise the configuration can be uploaded to the system using Manager after initial installation of the system.

- The configuration created must match the physical equipment in the IP Office system onto which the configuration will be loaded. Doing otherwise may cause the IP Office system to reset and experience other problems.

1. Start IP Office Manager with no configuration loaded into Manager
2. Click on Create an Offline Configuration in the simplified view.

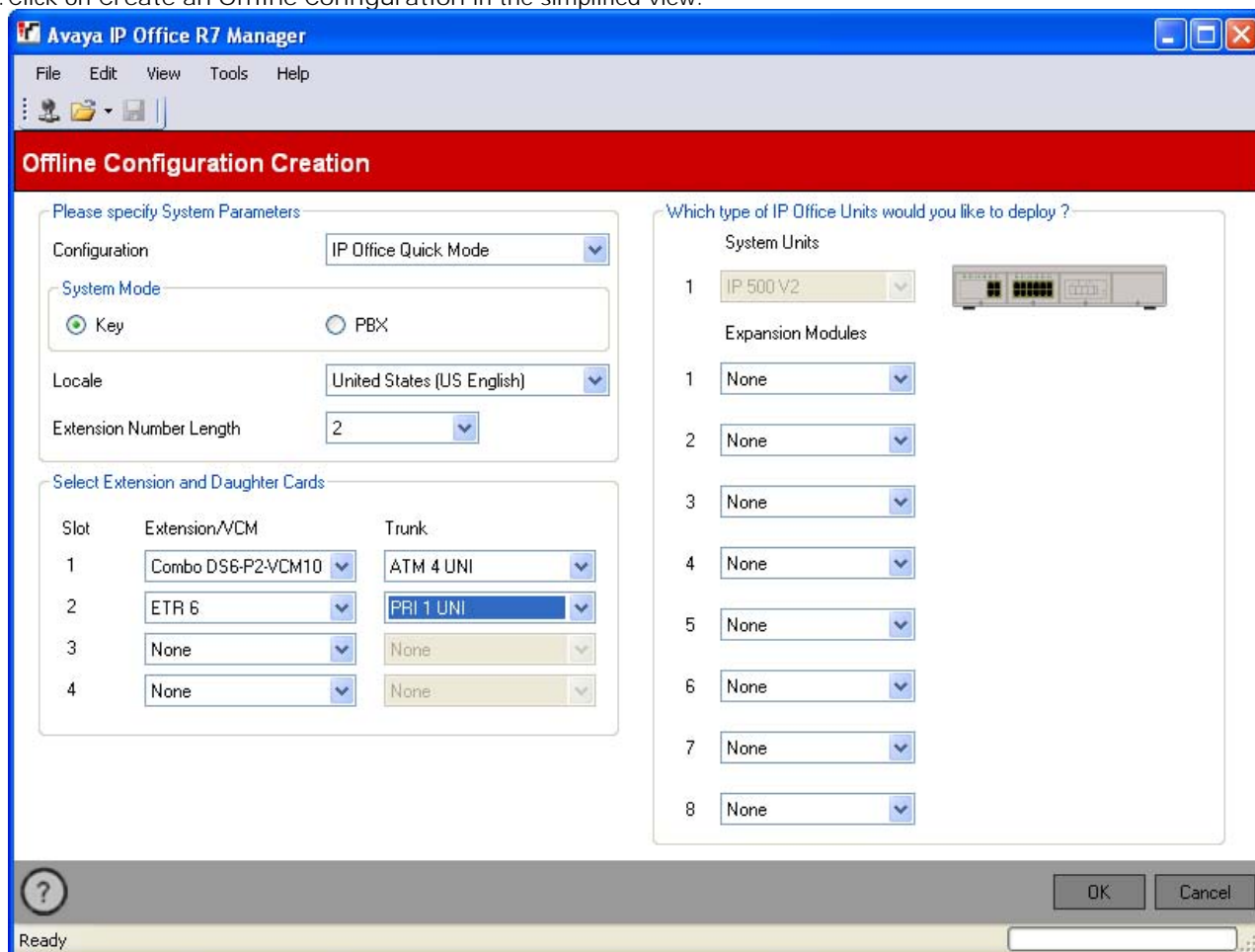

3. Select the type of configuration that you want to create. The equipment and settings will be restricted to those supported in the selected mode.
4. When completed click OK.
5. Manager will create and load the configuration.
6. Edit the configuration to match the customer requirements. This can include importing information from prepared CSV files.
7. When completed, select File | Save Configuration As.

4.4.4 Adding a License File

For IP500v2 control units, if a licence file called keys.txt is found in the SD card folder which the IP Office uses when it boots, the IP Office will merge the licenses in that file with its configuration.

The files should be a plain text file (UTF8) containing either:

- A license name and license key separated by a comma on each line.
 Teleworker, uAuToY@9VvVV@VOzIgeegwLXL2sAs1Z5
 Mobile Worker, NvWO_iVY5KJpZMNeY89IB1sIj0_QUCDm
 Power User, 9IJQW3yuPsbxjGS2XcMa16_J9H8cSeZ9
 System Advanced, JAWZaw@YtK37vcnXkqM4mDYDIIdSMd9_1
- A license key on each line.
 uAuToY@9VvVV@VOzIgeegwLXL2sAs1Z5
 NvWO_iVY5KJpZMNeY89IB1sIj0_QUCDm
 9IJQW3yuPsbxjGS2XcMa16_J9H8cSeZ9
 JAWZaw@YtK37vcnXkqM4mDYDIIdSMd9_1

1. Using a card reader, copy the file into the `/system/primary` folder on the System SD memory card.

4.4.5 Adding Music on Hold Files

By default the IP Office will use internal music on hold by uploading a music file from the IP Office Manager PC. For IP500v2 systems, you can load a file onto the System SD card prior to installing it in the IP Office.

The file must be of the following format and must be called `holdmusic.wav`.

Property	Value
File Type	WAV
Bit Rate	128kbps
Audio sample size	16 bit
Channels	1 (mono)
Audio Sample Rate	8 kHz
Audio Format	PCM
Length	Up to 90 seconds.

1. Rename the music file `holdmusic.wav`.
2. Using a card reader, copy the file into the `/system/primary` folder on the System SD memory card.
3. If the IP Office is or will be configured for additional hold music files (up to 3 additional files), copy those files to the same location. The name of the additional files must match those specified in the IP Office system's configuration.

4.5 IP500 Card Installation

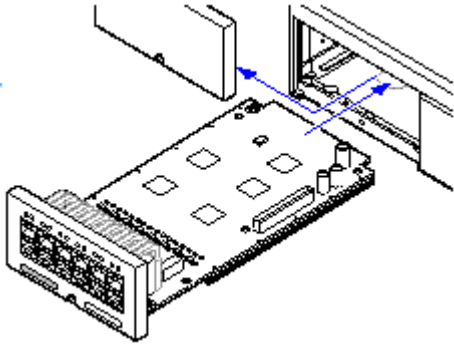

The IP500 base cards and trunk daughter cards should be fitted before power is applied to the control unit. Ensure that cards are inserted in the order that matches the planned or pre-built configuration.

1. [Fitting IP500 Trunk Daughter Cards to the Base Cards.](#) ⁶³
2. [Installing IP500 Cards into the Control Unit.](#) ⁶⁴

-  Warnings
 - Correct anti-static protection steps should be taken before handling circuit boards.
 - Cards must never be added or removed from the control unit while it has power connected.
- General Notes
 - Cards can be fitted in any order into any available slots.
 - For phone based administration, the card in slot 1 must be able to support ETR 18D, ETR 34D, M7324, M7310, T7316E, T7316, 1408 or 1416 phones.
 - It is recommended that cards are fitted from left to right.
 - There are restrictions to the number of supported cards of some types. When such a limit is exceeded, the right-most card of that type will not function.
 - Ensure that you use the labels supplied to identify the card fitted into the control unit.

4.5.1 IP500 Daughter Card Preparation

IP500 trunk daughter cards can be fitted to any IP500 base card. For IP500 Combination cards, the trunk daughter card is pre-installed and cannot be changed.

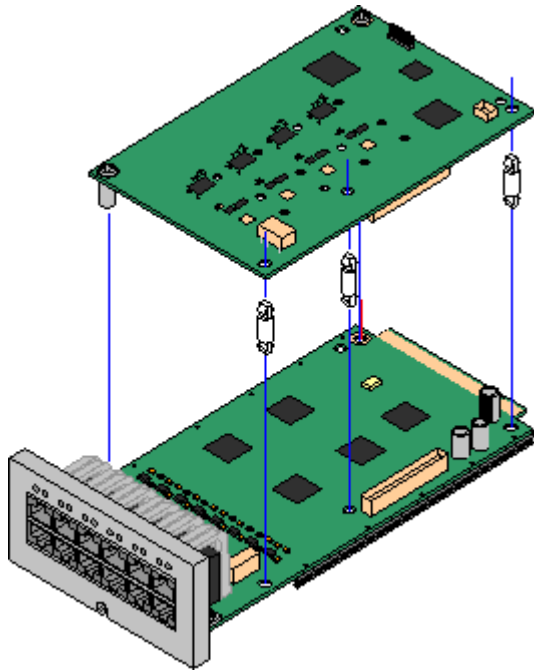

⚠ Warnings

1. Correct anti-static protection steps should be taken while handling circuit boards.

Parts and Equipment Required

1. □ IP500 Base Card
2. □ IP500 Trunk Daughter Card
3. □ 3 Stand Off Pillars
These are supplied with the trunk daughter card.

Tools Required.

1. □ 5mm Flat-blade screwdriver.
2. □ Anti-static wrist strap and ground point.

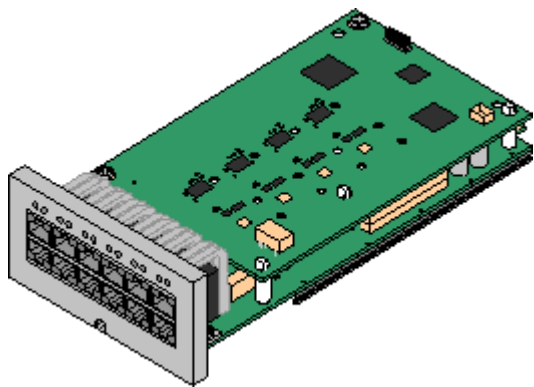

Procedure: Installing a Trunk Daughter Card

1. Check that correct cards have been supplied.
2. Ensure that you are wearing an anti-static wrist strap connected to a suitable ground point.
3. On the base card identify the position of 3 holes for the plastic pillars for the IP500 card. These are along the same edge as the card connector.
4. Fit the stand off pillars to the IP500 base card.
5. If there is a clip-on metal shield over the connector block on the base card, remove it.
6. Using minimal force and checking that the pins are correctly located, push the IP500 trunk card onto its connector block and the stand off pillars.
7. Check that the card connector has snapped into position.
8. Using the washers and screws provided, secure the metal stand off pillars to the base card.
9. A set of labels are supplied with the trunk daughter card. Fit the appropriate label to the front of the base card.

4.5.2 IP500 Card Insertion

Having prepared each IP500 base card by adding any [trunk daughter card](#) ⁶³, the base card can be inserted into the control unit.

-  Warnings
 - Correct anti-static protection steps should be taken while handling circuit boards.
 - Cards must never be added or removed from the control unit while it has power connected.
- Tools Required
 - 5mm Flat-blade screwdriver.
 - Anti-static wrist strap and ground point.

Installing an IP500 Card

1. Check that there is no power to the control unit.
2. Using a flat-bladed screwdriver, remove the cover from the slot on the front of the control unit that will be used for each card being installed. This cover is no longer required but should be retained until installation has been completed.

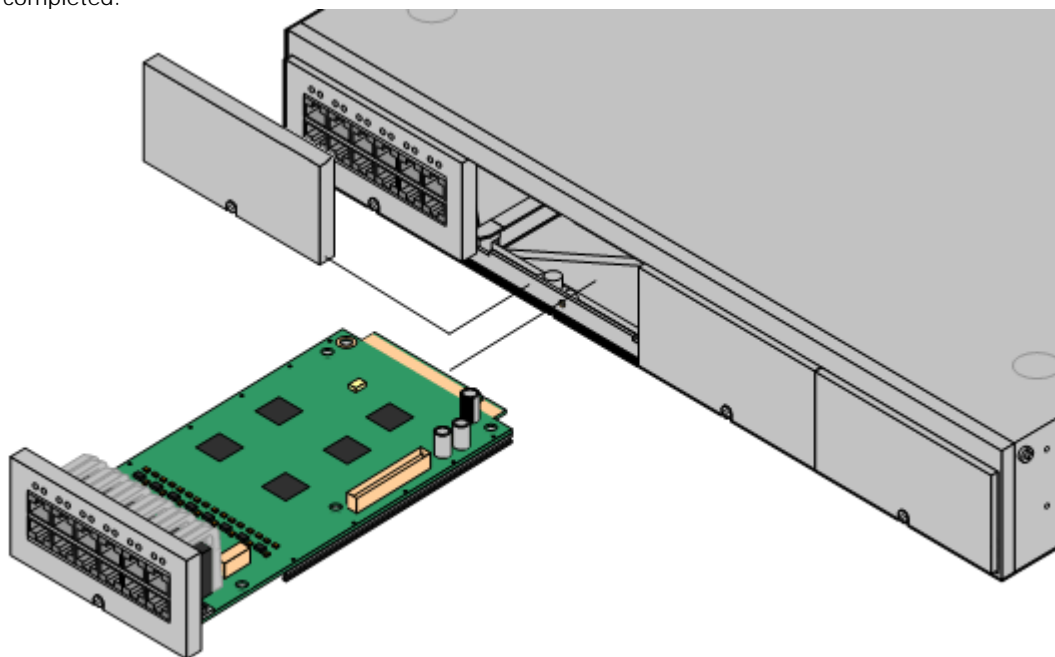

3. Allowing the card to rest against the bottom of the slot, begin sliding it into the control unit. When half inserted, check that the card rails have engaged with the slot edges by trying to gently rotate it. If the card rotates remove it and begin inserting it again.
4. The card should slide in freely until almost fully inserted. At this point apply pressure at the base of the front of the card to complete insertion.
5. Using a flat-bladed screwdriver secure the card.

4.6 Wall Mounting

IP500, IP500v2 control units and IP500 external expansion modules can be wall mounted. To do this, a wall mounting kit is required in addition to suitable wall fixings. Wall mounting is not supported for IP400 external expansion modules.

In addition to the existing [environmental requirements](#) for an IP Office system, the following additional requirements apply when wall mounting a unit:

- The wall surface must be vertical, flat and vibration free. Attachment to temporary walls is not supported.
- Only the screws provided with the mounting kit should be used to attach the brackets to the control unit.

The following wall mounting kits exist.

- IP500 Wall Mounting Kit V2 (*SAP Code 700500923*)

This kit can be used for wall mounting an IP500 or IP500 v2 control unit and IP500 external expansion modules. This kit incorporates cable routing at the front and rear of the unit. For control units it allows orientation of the control unit base card slots to the left or to the right.

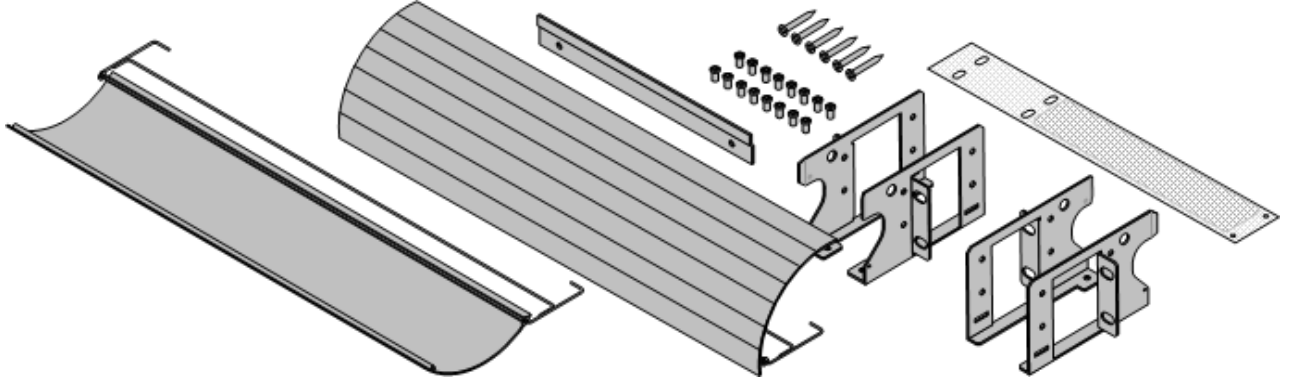

- IP500 Wall Mounting Kit (*SAP Code 700430150*)

This old design of wall mounting kit can be used for wall mounting an IP500 or IP500v2 control units only. It does not provide any cable routing and requires the control unit to be mounted with the base card slots to the right only.

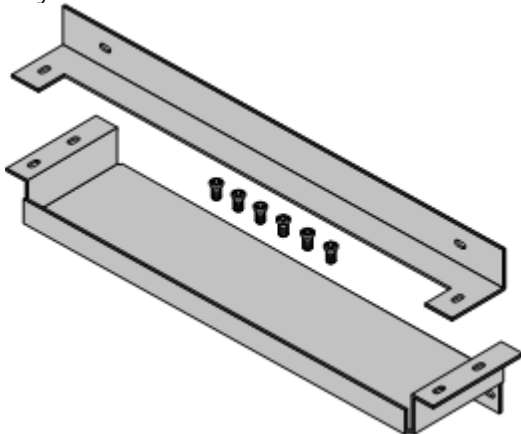

4.6.1 Wall Mounting Kit V2

These notes relate to the newer V2 design of wall mounting kit (*SAP 700500923*). This kit can be used to wall mount IP500 and IP500v2 control units and IP500 external expansion modules.

The kit includes brackets to attach the cable covers to the front and back of the control unit, a wall bracket and a fire screen that is inserted into the bottom of the control unit. It also includes screws for attachment to a plywood surface.

In addition to the existing [environmental requirements](#) ^[38] for an IP Office system, the following additional requirements apply when wall mounting a unit:

- The wall surface must be vertical, flat and vibration free. Attachment to temporary walls is not supported.
- Only the screws provided with the mounting kit should be used to attach the brackets to the control unit.
- The installation must be done by a service person only.
- For control units, the mesh must be installed in the control unit before mounting and at the bottom of the unit.
- Ensure that the system has been shutdown and power has been removed from all the units. Shutdown the system using a shutdown command and then remove power. Do not simply remove the power.
- If mounting a control unit, you must wait at least 15 minutes after removing the power cord before fitting the flame screen.
- A suitable mounting surface of at least 19mm (0.75 inch) plywood is required.

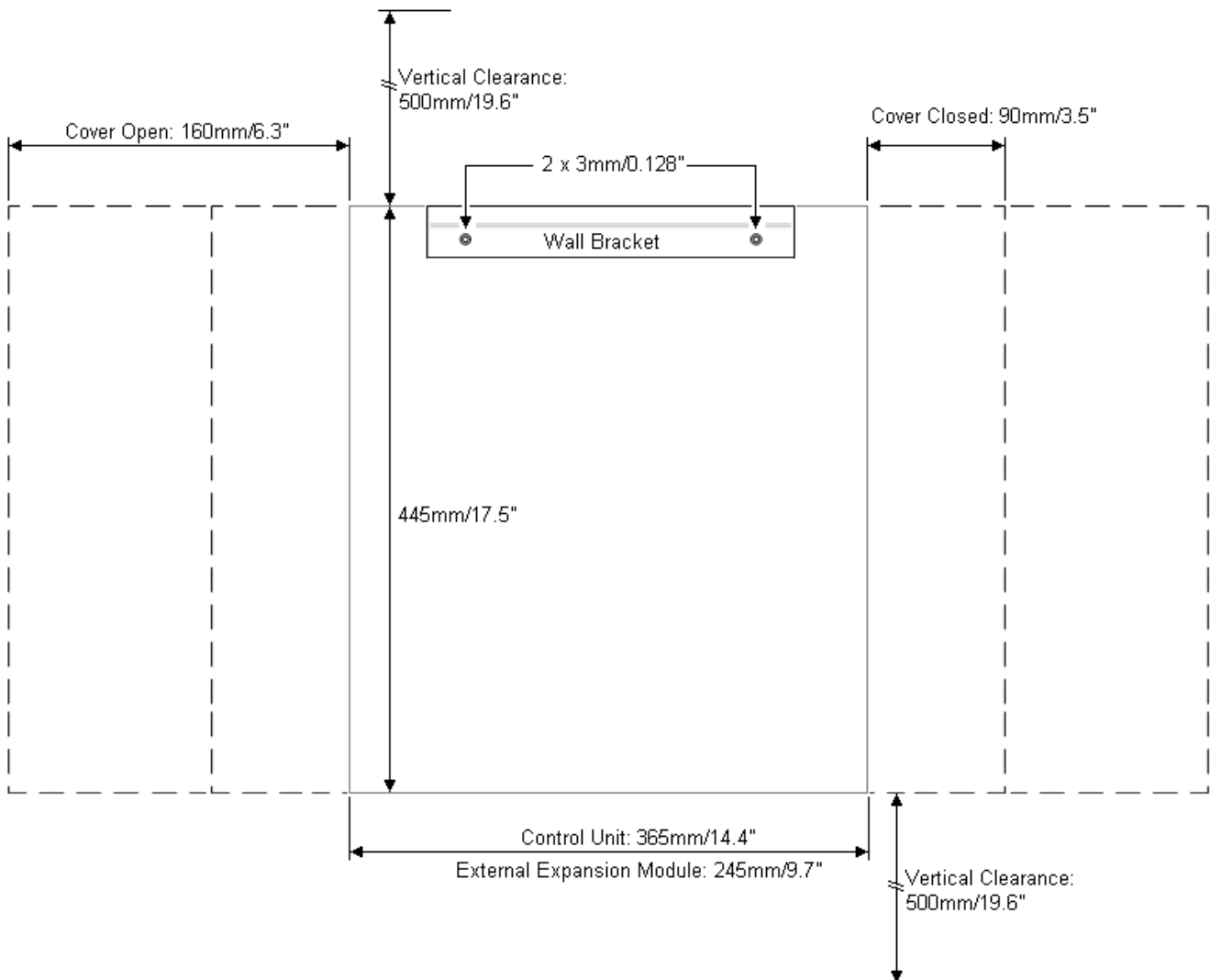
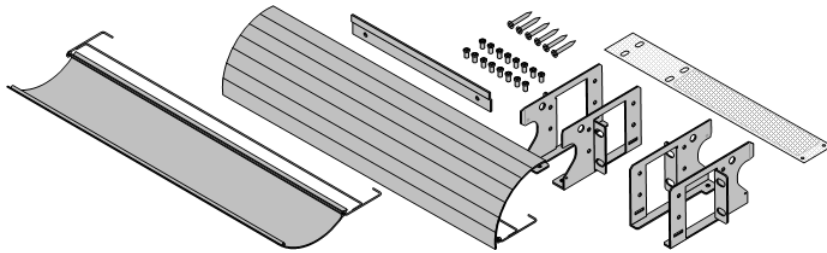

Wall Mounting Process

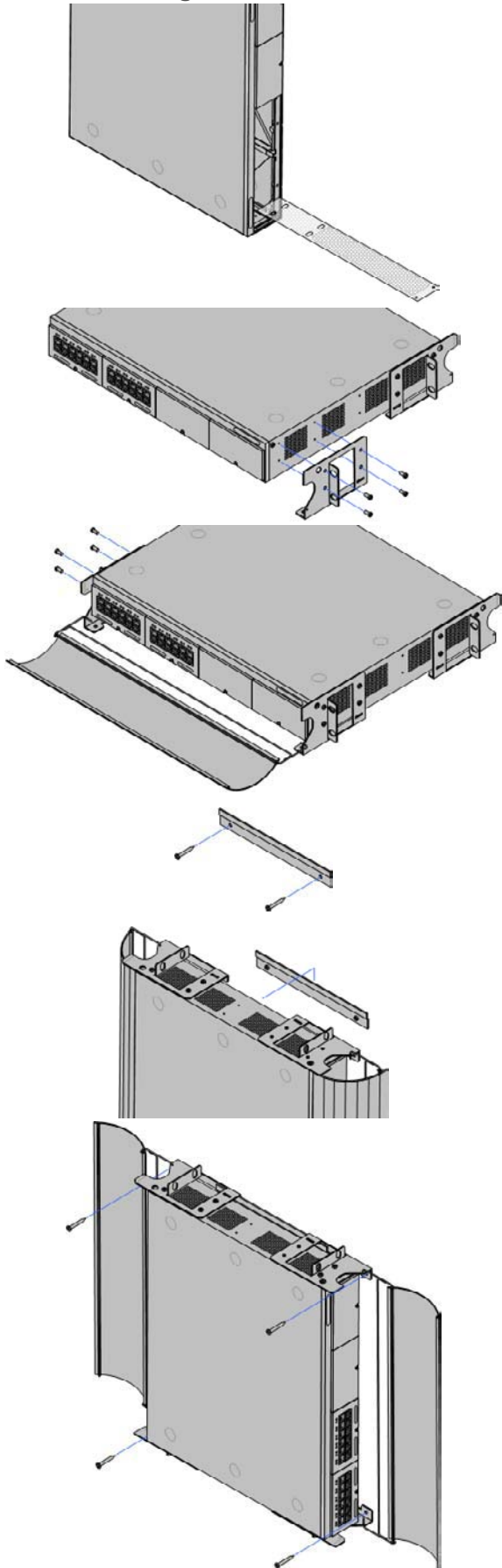

1. Shutdown the System

Ensure that the system has been shutdown and power has been removed from all the units.

- If mounting a control unit, you must wait at least 15 minutes after removing the power cord before fitting the flame screen.
- Shutdown the system using a shutdown command and then remove power. Do not simply remove the power.

2. Fit the Flame Screen (Mandatory - Control Units Only)

- **! WARNING:** The flame screen mesh must be fitted.
 - a. Remove the cards or blank slot covers from the 2 slots that will be at the bottom when the control unit is wall mounted.
 - b. Insert the flame screen into the bottom of the control unit, with the two black plastic pegs at the front.
 - c. Press the two pegs through the air flow holes in the control unit casing.
 - d. Check that the pegs have come through and have secured the flame screen in place.
 - e. Reinsert the base cards or reattach the blank slot covers.

3. Attach Brackets on One Side

On one side of the unit, attach one pair of the metal brackets.

- Only use the screws provided with the wall mounting kit for attaching the metal brackets.

4. Attach the Cable Cover and Bracket

- a. Hook one of the cable frames into the leading hole of one of the metal brackets.
- b. Hook another bracket onto the other end of the cable frame and then attach that bracket to the unit.
- c. Repeat the process to attach the other cable frame and cover to the unit.

5. Fit the Wall Bracket

Using 2 of the screws provided with the kit, attach the wall bracket to the plywood surface.

6. Place the Unit onto the Wall Bracket

Lift the unit onto the wall bracket. The two metal brackets at the top of the unit hook over the top of the wall bracket.

7. Attach the Unit to the Wall Panel

Using the remaining 4 screws provided with the kit, fix the cover brackets to the plywood surface.

4.6.2 Wall Mounting Kit V1

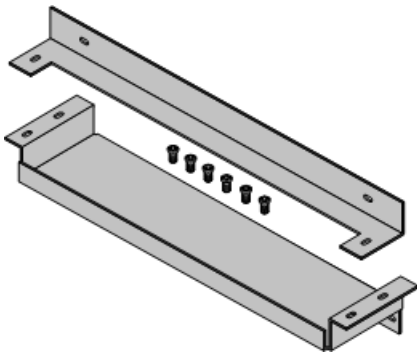

These notes relate to the older design of wall mounting kit (*SAP 70043015*) used for IP500 and IP500v2 control units. This kit cannot be used for external expansion modules.

The kit includes two brackets, one top and one bottom, and screws for attachment to the control unit. Additional 4 x 4.5mm fixtures and fittings are required suitable for the wall type.

In addition to the existing [environmental requirements](#) [38] for an IP Office system, the following additional requirements apply when wall mounting a unit:

- The wall surface must be vertical, flat and vibration free. Attachment to temporary walls is not supported.
- Only the screws provided with the mounting kit should be used to attach the brackets to the control unit.
- The brackets must be used as shown, with the deeper tray-like bracket used at the bottom of the wall mounted control unit.

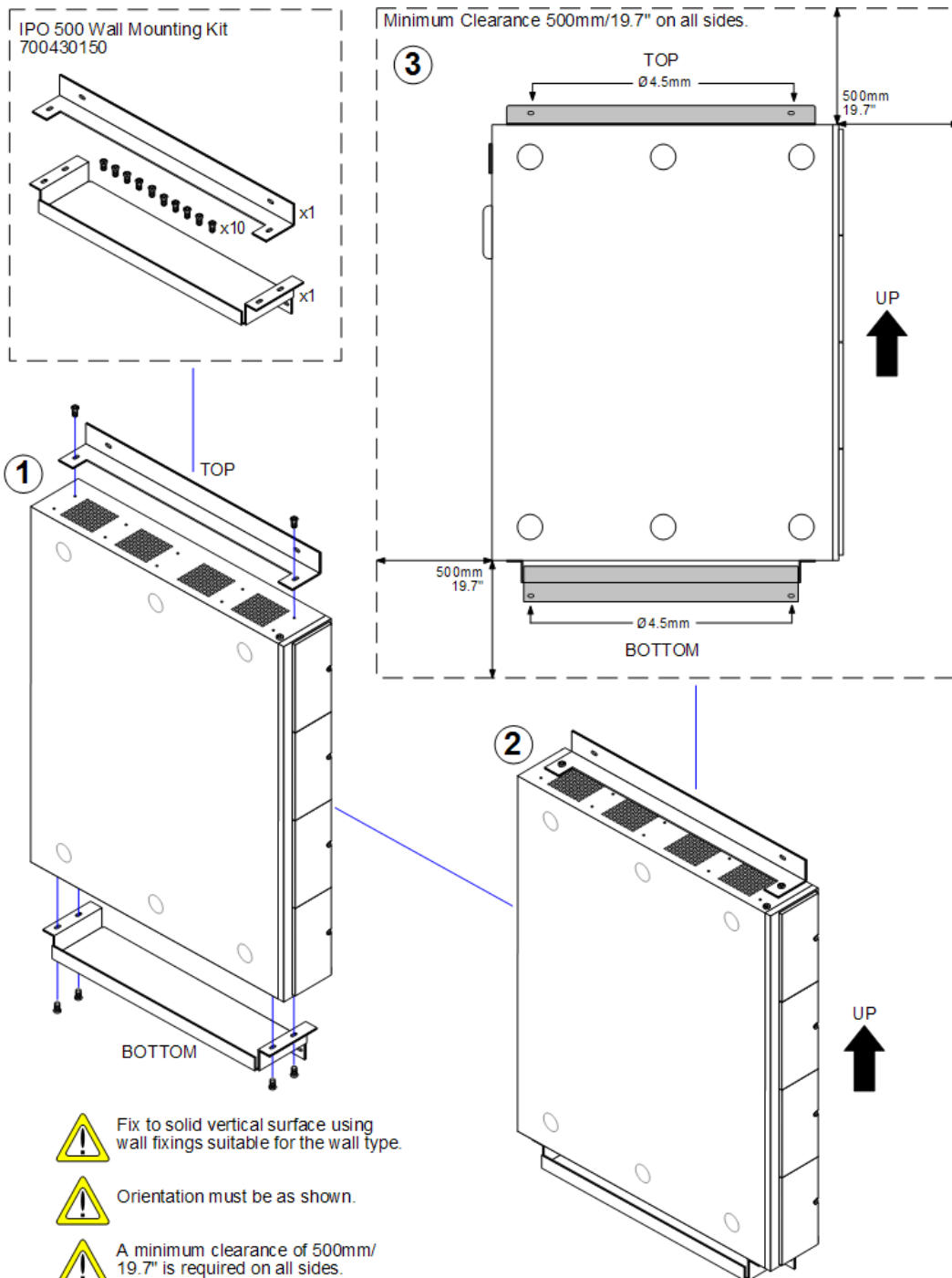

4.7 Rack Mounting

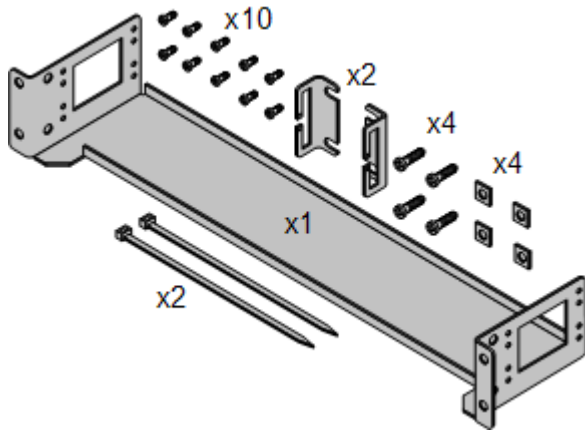

The IP500 control unit and IP500 external expansion units can be rack mounted if required into 19-inch rack systems. This requires an IP500 Rack Mounting Kit (SAP 700429202) for each unit.

The kit includes:

- A rack mounting bracket and screws for attachment of the bracket to the unit
- Nuts and bolts for rack attachment.
- Brackets and cable ties for cable tidying.

As indicated in the diagram following, the rack mounting bracket can be used in several positions on the unit. IP400 external expansion units used in an IP500 system can also be rack mounted but use a separate IP400 Rack Mounting Kit.

Environmental Requirements

In addition to the existing [environmental requirements](#) ⁽³⁸⁾ for an IP Office system, the following additional factors must be considered when rack mounting a unit:

1. Rack Positioning - Ensure compliance with the rack manufacturers safety instructions. For example check that the rack legs have been lowered and fixing brackets have been used to stop toppling.
2. Elevated Operating Ambient - If installed in a closed or multi-unit rack assembly, the operating ambient temperature of the rack environment may be greater than room ambient. Therefore, consideration should be given to installing the equipment in an environment compatible with the maximum ambient temperature (T_{ma}) specified by the manufacturer.
 - Operating Temperature: 0°C (32°F) to 40°C (104°F).
 - Operating Humidity: 10% to 95% non-condensing.
3. Reduced Air Flow - Installation of the equipment in a rack should be such that the amount of air flow required for safe operation of the equipment is not compromised. Proper ventilation must be maintained. The side ventilation slots on the IP500 control unit should not be covered or blocked.
4. Mechanical Loading - Mounting of the equipment in the rack should be such that a hazardous condition is not achieved due to uneven mechanical loading.
5. Circuit Overloading - Consideration should be given to the connection of the equipment to the supply circuit and the effect that overloading of the circuits might have on overcurrent protection and supply wiring. Appropriate consideration of equipment nameplate ratings should be used when addressing this concern.
6. Reliable Earthing - Reliable earthing of rack-mounted equipment should be maintained. Particular attention should be given to supply connections other than direct connections to the branch circuit (e.g. use of power strips).
7.  Only the screws provided with the mounting kit should be used to attach the brackets to the control unit.

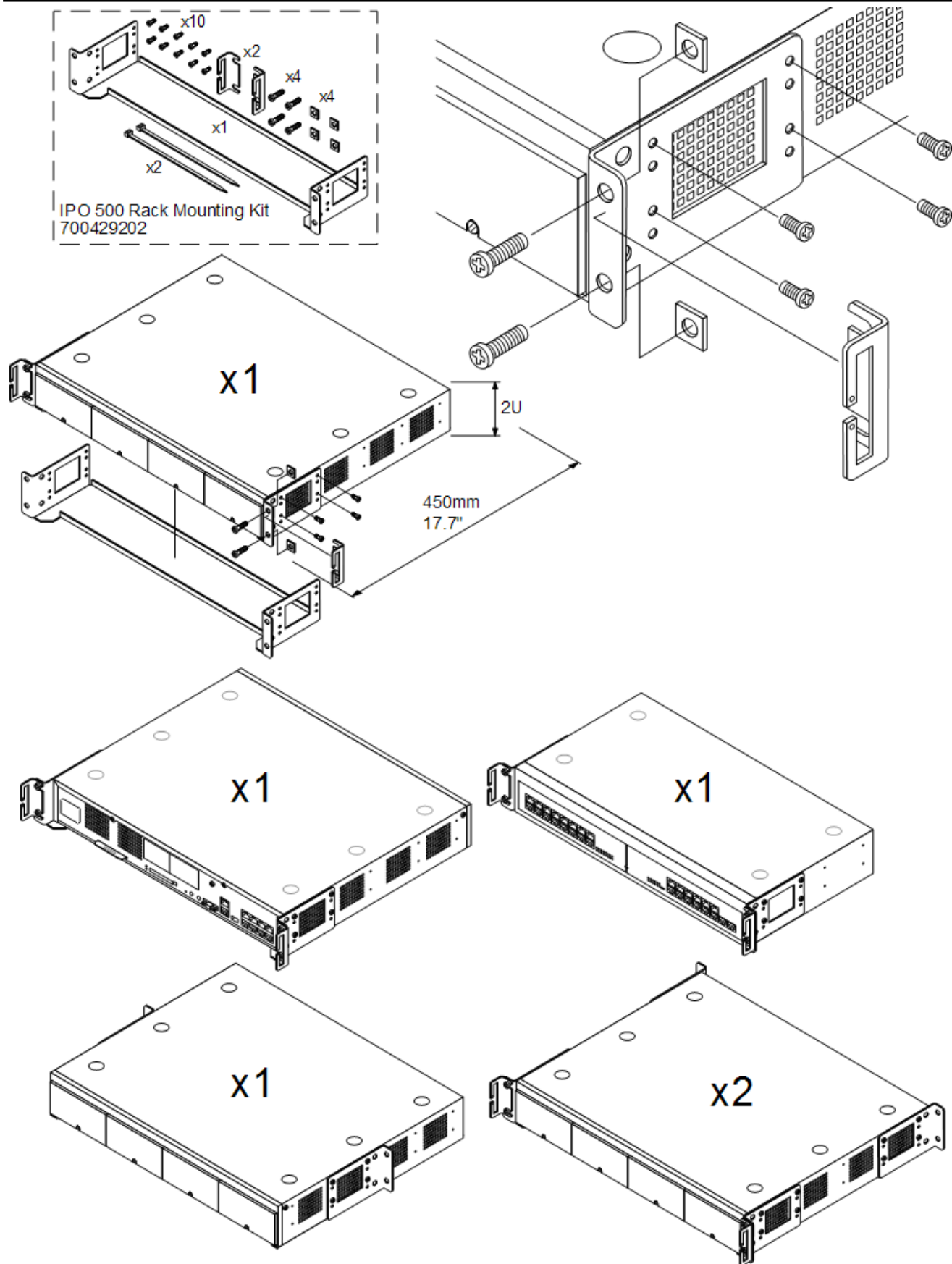

-  Only the screws provided with the mounting kit should be used to attach the brackets to the control unit.

4.8 Connecting External Expansion Modules

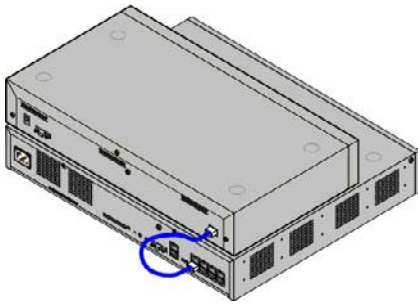

Any external expansion modules should be connected to the control unit before power is applied to the control unit. Ensure that modules are attached in the order that matches the planned or pre-built configuration.

External expansion modules connect to the IP Office control unit using an expansion interconnect cable. Each module is supplied with an expansion connect cable and a [power supply unit](#)^[20]. An appropriate [locale specific power cord](#)^[21] for the power supply unit must be ordered separately.

- Each external expansion module is supplied with a blue 1 meter (3'3") expansion interconnect cable. This cable must be used when connecting to expansion ports on the rear of a control unit.

Installation Requirements

- Installation space either on or under the existing IP Office control unit.
- Switched power outlet socket.
- Available EXPANSION port on the control unit.
- Grounding Requirements
 - Functional Grounding
Connection of a [functional earth](#)^[25] is:
 - Recommend for all modules.
 - Connection of a functional ground is mandatory for Analog Trunk modules.
 - Protective Grounding
Connections of a protective ground via [surge protection equipment](#)^[26] is:
 - Mandatory for Analog trunk modules in the Republic of South Africa.
 - Mandatory for Digital Station and Phone modules connected to out of building extensions.
 - Mandatory for Digital Station V2 and Phone V2 modules.

Tools Required

- Manager PC.
- [Tools for rack mounting](#)^[69] (optional).

Parts and Equipment Required

- External Expansion Module.
Each module is supplied with a suitable external power supply unit and a 1m blue interconnect cable. 2m Yellow interconnect cables are supplied with the IP500 4-Port Expansion card and should only be used with that card.
- [Power cord for the power supply unit](#)^[21].
- [Rack mounting kit](#)^[27](optional).
- Wall mounting kit - IP500 external expansion modules only (optional).
- Cable labeling tags.

Procedure

1. External expansion modules should not be attached to a control unit that has power.
2. If the IP Office system is being installed in a rack, attach the [rack mounting kit](#) to the expansion module.
3. Attach the external expansion module's power supply but do not switch power on.
4. Connect the expansion interconnect cable from the module's EXPANSION port to the EXPANSION port on the control unit. Make careful note of the port used and include this detail on the cable label and any other system records.

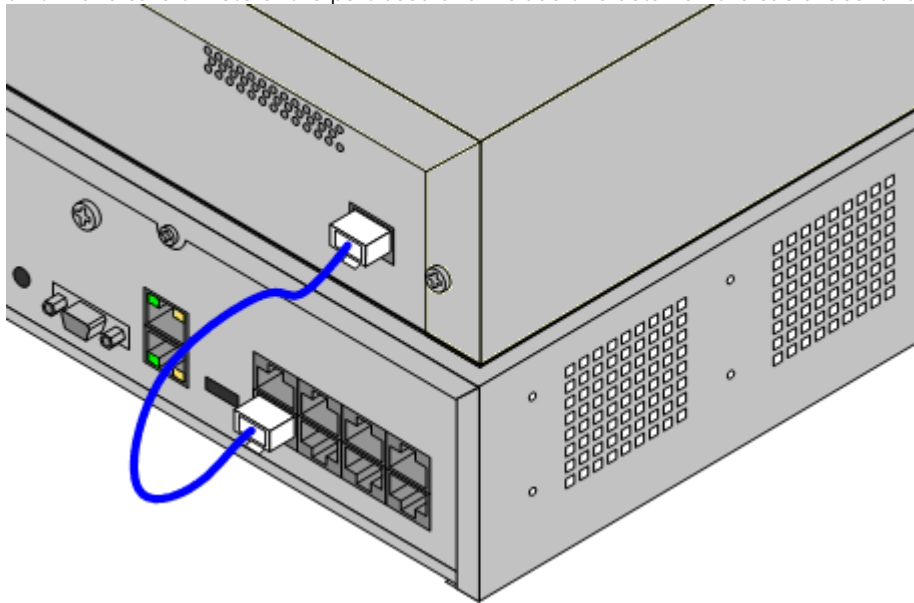

4.9 Grounding

Use of ground connections reduces the likelihood of problems in most telephony and data systems. This is especially important in buildings where multiple items of equipment are interconnected using long cable runs, for example phone and data networks.

All IP Office control units and external expansion modules must be connected to a functional ground. Where the unit is connected to a power outlet using a power cord with an earth lead, the power outlet must be connected to a protective earth.

In some cases, such as ground start trunks, in addition to being a protective measure this is a functional requirement for the equipment to operate. In other cases it may be a locale regulatory requirement and or a necessary protective step, for example areas of high lightning risk.



-  **WARNING**
During installation do not assume that ground points are correctly connected to ground. Test ground points before relying on them to ground connected equipment.
- **Additional protective equipment**
In addition to grounding, additional protective equipment will be required in the following situations.
 - On any Digital Station or Phones external expansion module connected to an extension located in another building. Refer to "[Out of Building Telephone Installations](#)"²⁶".
 - In the Republic of South Africa, on all Analog Trunk external expansion modules (ATM16) and on any control units containing an analog trunk cards (ATM4/ATM4U).

Tools Required

- M4 Cross-Head Screwdriver.
- Tools suitable for crimping a cable spade.

Parts and Equipment Required

- 14AWG Solid copper wire for ground connection.
- Cable sleeve matching local regulator requirements. Typically green for a functional ground and green/yellow for a protective ground.

The ground point on IP Office control units and expansion modules are marked with a  or  symbol. Ground connections to these points should use a 14 AWG solid wire with either a green sleeve for a functional ground or green and yellow sleeve for a protective ground.

IP500/IP500v2 Control Unit

On IP500 control units the ground point is located above the RS232 DTE port.

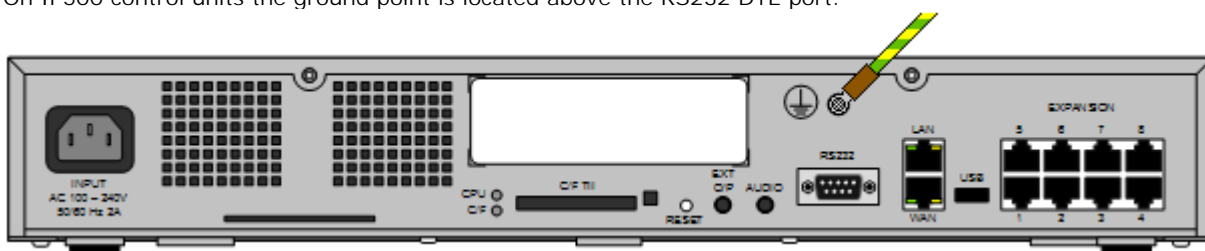

External Expansion Modules

On expansion modules, the ground point is a 4mm screw located towards the right on the rear of the module.

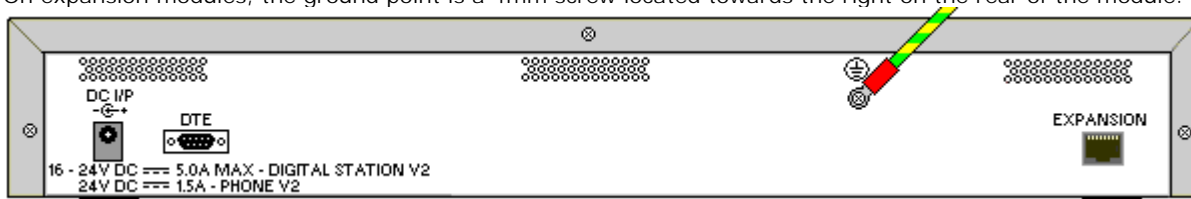

- On some older modules, the dedicated ground point screw is not present. In those cases, the top-center cover fixing screw (3mm) can be used as an alternative ground connection point. A toothed washer should be added to ensure good contact.

4.10 Network Connection

The section below details how a new IP Office system determines what IP address it should use. Note that this only applies for a new system loading IP Office Release 7.0 and higher.

IP Address and DHCP Mode Resolution

When a defaulted or new IP Office control unit is switched on, it requests IP address information from a DHCP Server on the network. This operation will occur whether the LAN cable is plugged in or not. The process below is done separately for both the LAN port (LAN1 in the configuration) and the WAN port (LAN2 in the configuration) on the back of the IP Office control unit.

- The IP Office makes a DHCP request for what IP address information it should use.
- If a DHCP server responds within approximately 10 seconds, the control unit defaults to being a DHCP client and uses the IP address information supplied by the DHCP server.
- If no DHCP Server responds, the control unit still defaults to being the DHCP client but assumes the following default addresses:
 - LAN1: 192.168.42.1/255.255.255.0.
 - LAN2: 192.168.43.1/255.255.255.0.
 - Note that the IP Office does not check that these addresses are valid and or available on the network.
- **!** Once an IP500v2 control unit has obtained IP address and DHCP mode settings, it will retain those settings even if rebooted without a configuration file present on the System SD card. To fully remove the existing IP address and DHCP mode setting the IP Office must be defaulted using IP Office Manager.

PC Connection

Depending on the conditions that applied when the IP Office control unit was first started, a PC can be connected as follows:

- If the IP Office is not connected to a network:
Connect the PC directly to the IP Office. It must be set to an address valid on the same network as the IP Office defaults above.
- If the IP Office is connected to a network with no DHCP server:
Connect the PC directly to the IP Office. It must be set to an address valid on the same network as the IP Office defaults above.
- If the IP Office is connected to a network with a DHCP server:
Connect the PC to the network. It must be set to be a DHCP client or to an address that is valid for the network.

4.11 Starting the System

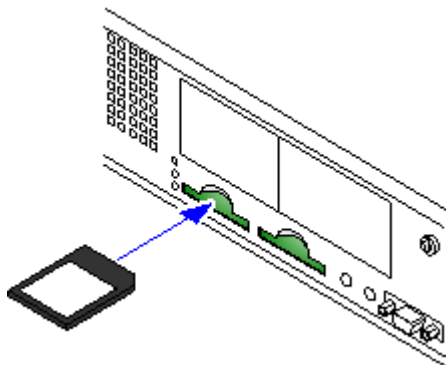

1. With the IP500v2 control unit shut down or unpowered, insert the Avaya System SD card into the System SD slot on the rear of the control unit.
 - Ensure that you have the correct card.
 - Ensure that the card has the level of software required. If necessary the card can be [upgraded to match a version of IP Office Manager](#) ⁵⁸.
2. Apply power to the external expansion modules if any. The power outlet used must include a switch and in cases where the power cord includes an earth lead, that outlet must have a protective earth connection.
3. Apply power to the IP500v2 control unit. The power outlet used must include a switch and the power outlet must have a protective earth connection.
4. The control unit will begin loading firmware from the System SD card with which it will upgrade itself and the components installed in the control unit.
5. This process takes approximately a minute. The end of this process will be indicated by LED1 on each base card flashing every 5 seconds. LED9 on each base card fitted with a trunk daughter card will also flash every 5 seconds.
6. The control unit will then begin upgrading the external expansion modules. This will be indicated by the red center LED on each module flashing red. The process is completed when the LED changes to steady green.
7. If a configuration file is already [present on the System SD](#) ⁵⁸ card it is loaded by the IP Office. If not, the IP Office creates a default configuration based on the components of the system and copies that configuration onto the System SD card.
8. It should be possible now to use IP Office Manager to access the configuration of the IP Office.

The LEDs on the rear of the control unit go through the following sequence during a normal start up. Note that the times are approximately only:

LED	4s	4s	12s	5s	2s	5s	5s	10s	10s	Finished
CPU	Orange	Green	Green	Green Red	Green	Green	Green	Green	Green	Green
System SD	Orange	Off	Green	Green	Green	Off	Green	Green	Green Flash	Green
Optional SD If present.	Orange	Off	Green	Green	Green	Off	Off	Green	Green	Green

On the front of the control unit, LED1 on any IP500 base cards fitted is used as follows. LED9 is also used for any trunk daughter cards fitted.

LED	30s	30s	Finished
LED1/LED9	Red	Red	Red
		Fast Flash	Flash every 5 seconds

4.11.1 Checking the LEDs

Control Unit LEDs

LED	Description
Optional SD	<ul style="list-style-type: none"> Off = Card shutdown (129). Green on = Card present.
System SD	<ul style="list-style-type: none"> Green flashing = Card in use. Orange steady = Reset imminent. Red flashing = Card initializing or shutting down. Red fast flashing = card full Red steady = Card failure/wrong type.
CPU	<ul style="list-style-type: none"> Alternate red/green = Starting up. Green on = Okay. Red on = No software. Flashing Red = Error/Shutdown.

Base Card LEDs

Base Card	LEDs 1 to 8 Usage
All Cards	<ul style="list-style-type: none"> LED1 is also used for base card status: <ul style="list-style-type: none"> Red On = Error Red Slow Flash = Initializing. Red Flash every 5 seconds = Card okay. Red Fast Flash = System shutdown.
IP500 Analog Phone	<ul style="list-style-type: none"> No status LEDs are used for analog phone extensions.
IP500 Digital Station	<ul style="list-style-type: none"> Green On = Phone detected.
IP500 Combination	LEDs 1 to 6 <ul style="list-style-type: none"> Green On = Phone detected.

Trunk Daughter Card LEDs

Trunk Daughter Card	LEDs 9 to 12 Usage
All cards	<ul style="list-style-type: none"> LED 9 is also used for daughter card status. <ul style="list-style-type: none"> Red On = Error Red Slow Flash = Initializing. Red Flash every 5 seconds = Card okay. Red Fast Flash = System shutdown.
Analog Trunk	<ul style="list-style-type: none"> Green on = Card fitted. Green flashing = Trunk in use.
PRI Trunk	<ul style="list-style-type: none"> Off = No trunk present. Green on = Trunk present. Green flashing = Trunk in use. Red/Green Fast Flash (port 9) or Green Fast Flash (port 10) = Alarm indication signal (AIS) from the trunk remote end. Red with Green Blink (port 9) or Green Blink (port 10) = Port in loopback mode (set through IP Office System Monitor).
BRI Trunk	<ul style="list-style-type: none"> Off = No trunk present. Green on = Trunk present. Green flashing = Trunk in use.

External Expansion Module LEDs

- Green on = Module okay.
- Red flashing = Module starting up/Loading firmware.
- Green flashing = Module starting up/Loading firmware (IP500 DS16A/30A module).
- Red on = Error.

4.12 Changing the System to Standard Mode

IP Office Essential Edition - Quick Version is the default mode assumed by a new or defaulted control unit fitted with an IP Office A-Law or IP Office Mu-Law SD card. If this is not the mode required for the IP Office system, IP Office Manager can be used to change the system to IP Office Standard Version.

The process below will change the mode of the system and default its configuration.

- **! WARNING**
This process will require the IP Office system to reboot in order to complete the process. Any current calls and services will be ended by the reboot.

Manual Changing to IP Office Standard Version Mode

1. Using IP Office Manager, receive the configuration from the system. The Manager application will automatically switch to its simplified view as the configuration from a system running in IP Office Essential Edition - Quick Version.
2. Select File | Advanced | Switch to Standard Mode (Default).
3. From the Select IP Office menu, select the IP Office system and click OK.
4. Enter the service user name and password. The defaults are *Administrator* and *password*.
5. A change mode warning is displayed. Selecting Yes will reboot the IP Office system.

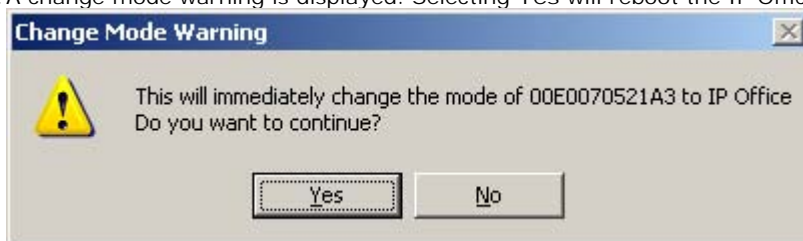

6. Once the system has rebooted, use IP Office Manager to again receive the configuration from the system. The user name and password for configuration should be the IP Office Standard Version mode defaults *Administrator* and *Administrator*.
7. The Manager application will automatically switch to its advanced view as the configuration is from a system running in IP Office Standard Version.

Automating the Change to IP Office Standard Version Mode

If the only systems that you install all need to be in IP Office Standard Version mode, the Manager application can be used to automate part of the process above.

1. In IP Office Manager, select File | Preferences.
2. On the Preferences sub-tab, enable Convert default Quick mode to Standard mode.

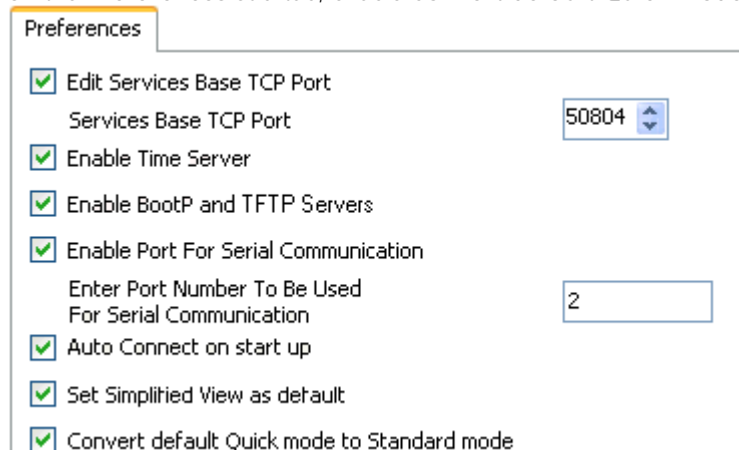

3. With this option enabled, when a configuration for a new or defaulted system running in IP Office Essential Edition - Quick Version mode is loaded, Manager will automatically convert the configuration to IP Office Standard Version mode. Sending the configuration back to the system will then restart the system in IP Office Standard Version mode.
 - This setting does not affect existing IP Office Essential Edition - Quick Version systems with non-default configurations.

4.13 Connecting Phones

During initial power up, the IP Office automatically creates extension and user entries for all analog and digital extension ports (DS and TCM) in the system. This allows those devices to be connected without any additional programming.

- **! Warning**
If the system has been upgraded from a previous release of IP Office software, all phones will be restricted from making any calls until a [system upgrade license](#) ^[21] has been entered. The dialing restriction includes not being able to make emergency calls.
- This section does not cover the installation of DECT, H323 and SIP telephones. For installation of those devices refer to the appropriate supplementary installation manuals.

Analog Phones

Connect any analog phones to their appropriate [Phone](#) ^[20] ports. Ensure that those connected to [power failure ports](#) ^[36] are clearly labeled as such.

ETR Phones

Connect any ETR phones to their appropriate [ETR](#) ^[20] ports. These phones do not need to load additional firmware.

TCM Port Phones

Connect any TCM phones to their appropriate [TCM](#) ^[20] ports. These phones do not need to load additional firmware.

For some types of phone, the phone can only report its general type to the IP Office but not the specific model. It is recommended that after connecting all the phones, the phone types should be correctly set in the IP Office configuration.

- **! Important**
The default types cannot be changed after installation without defaulting the configuration. Therefore you must ensure that you connect the correct type of phone to each port.
1. Using IP Office Manager, receive the configuration from the system.
 2. Select Extension.
 3. Selecting each extension in turn, on the Extn tab, check that the Device Type field is set to the correct phone model.

Default Type	Possible Phone Models
T7100	T7100, MT7100, MT7100N, Audio Conferencing Unit.
T7208	T7208, MT7208, MT7208N.
M7310	T7406E, T7406, M7310, M7310N
M7310BLF	T7316, M7310BLF
M7324	M7324, M7324N

4. Save the configuration back to the IP Office system.

DS Digital Stations

Connect any digital phones to their appropriate [DS](#) ^[20] ports. These phones may need to upgrade their firmware to match that supported by the IP Office core software. The appropriate firmware is supplied with the IP Office Manager software and copied onto the System SD card for IP500v2 systems.

The phones will automatically load the firmware from the IP Office system if necessary.

- The upgrade process takes approximately 10 minutes during which time the phone will display a warning. The phone should not be disconnected during this process.
- Due to memory requirement, only 10 phones of the same type can be upgraded at a time. Starting from the first port needing to be upgraded, the IP Office will upgrade all connected phones of the same type needing upgrading in batches. It will then upgrade the next connected type of phones needing to be upgraded.
- Once the phone connected to a port has been upgraded, the IP Office will not check whether the phone on that port needs to be upgraded again except following a system reboot, i.e. multiple phones cannot be upgraded by swapping the connected phones on the same.

Chapter 5.

Initial Configuration

5. Initial Configuration

This section covers basic configuration changes required for all IP Office systems.

- [Setting the System Locale](#)^[81]
Setting the correct system locale affects a wide range of settings including trunk settings. The correct locale must be set for a system to operate correctly.
- [Select Key System or PBX System Mode](#)^[82]
The system can run in key system or PBX system modes.
- [Extension Numbering](#)^[85]
Change the numbering mode used by the system between 2-digit and 3-digit. Renumber the user extensions if required.
- [Change the Default Passwords](#)^[84]
The default passwords used for configuration access to the IP Office system should be changed.
- [Change the IP Address/DHCP Settings](#)^[83]
If necessary, the IP address and DHCP mode of the IP Office system can be changed.
- [Entering Licenses](#)^[86]
If not already done, enter licenses for features that require them.

5.1 Setting the System Locale

Setting the correct [system locale](#)^[32] affects a wide range of settings including trunk settings. The correct locale must be set for a system to operate correctly. It will also set the default language used for phone displays and for voicemail prompts. However language settings can be changed separately from the system locale if different language operation is required.

- **! WARNING**
This process will require the IP Office system to reboot in order to complete the process. Any current calls and services will be ended by the reboot.
- This process can be performed through [phone based administration](#)^[52] from either of the first two systems in the system. For details, refer to the IP Office Essential Edition - Quick Version Phone Based Administration manual.

Setting the System Locale

- This option can also be done through [phone based administration](#)^[52].
1. [Start Manager](#)^[50] and receive the configuration from the IP Office system.
 2. On the Manager home page, select Change System Settings (or from the Admin Tasks list select System).
 3. Use the Country drop down list to select the required locale.

- | | | | |
|--------------------|--------------------|-----------------------|-------------------------------|
| • <i>Argentina</i> | • <i>France</i> | • <i>Netherlands</i> | • <i>South Africa</i> |
| • <i>Australia</i> | • <i>Germany</i> | • <i>New Zealand</i> | • <i>Spain</i> |
| • <i>Bahrain</i> | • <i>Greece</i> | • <i>Norway</i> | • <i>Sweden</i> |
| • <i>Belgium</i> | • <i>Hong Kong</i> | • <i>Oman</i> | • <i>Switzerland</i> |
| • <i>Brazil</i> | • <i>Hungary</i> | • <i>Pakistan</i> | • <i>Taiwan</i> |
| • <i>Canada</i> | • <i>Iceland</i> | • <i>Peru</i> | • <i>Turkey</i> |
| • <i>Chile</i> | • <i>India</i> | • <i>Poland</i> | • <i>United Arab Emirates</i> |
| • <i>China</i> | • <i>Italy</i> | • <i>Portugal</i> | • <i>United Kingdom</i> |
| • <i>Colombia</i> | • <i>Korea</i> | • <i>Qatar</i> | • <i>United States</i> |
| • <i>Denmark</i> | • <i>Kuwait</i> | • <i>Russia</i> | • <i>Venezuela</i> |
| • <i>Egypt</i> | • <i>Mexico</i> | • <i>Saudi Arabia</i> | |
| • <i>Finland</i> | • <i>Morocco</i> | • <i>Singapore</i> | |

Use the Language drop down list to select the default language for the system.

4. Click Apply.
5. Click on the  save icon and save the updated configuration back to the IP Office system.

5.2 Select Key System or PBX System Mode

IP Office Essential Edition - Quick Version mode systems can operate in one of two ways, as a key system or as a PBX system. The mode adopted by a IP Office Essential Edition - Quick Version mode system depends on the System SD card. Systems with an IP Office U-Law card default to key system operation. Systems with an IP Office A-Law card default to PBX system operation.

- This process can be performed through [phone based administration](#) ⁵² from either of the first two systems in the system. For details, refer to the IP Office Essential Edition - Quick Version Phone Based Administration manual.

Key Mode vs PBX Mode - Quick Summary

Key Mode	PBX Mode
<ul style="list-style-type: none"> • The first 2 programmable buttons are used as intercom buttons. • Internal calls are made and answered using the intercom buttons. • External calls are made and answered using line appearance buttons. • The line used for outgoing external calls is determined by the line button pressed. • Automatic line selection defaults to the analog lines present and then the 2 intercom buttons. 	<ul style="list-style-type: none"> • The first 3 programmable buttons (2 on ETR phones) are used as call appearance buttons. • Internal calls are made and answered using the call appearance buttons. • External calls are made and answered using the call appearance buttons. • The line used for outgoing external calls is determined from the number dialed. • Automatic line selection defaults to the 3 call appearance buttons (2 on ETR phones).

- **! WARNING**
This process will require the IP Office system to reboot in order to complete the process. Any current calls and services will be ended by the reboot.

Selecting Key or PBX System Mode

- This option can be done through [phone based administration](#) ⁵².
1. [Start Manager](#) ⁵⁰ and receive the configuration from the IP Office system.
 2. On the Manager home page, select Change System Settings (or from the Admin Tasks list select System).
 3. Use the System Mode drop down list to select the required mode.
 4. Click Apply.
 5. Click on the  save icon and save the updated configuration back to the IP Office system.

5.3 Changing the IP Address Settings

When a new or defaulted IP Office is switched on, the control unit will make a DHCP requests for IP address settings on each of its LAN interfaces (LAN1 and LAN2).

- If the IP Office receives a response from a DHCP server, it will configure itself as a DHCP client using the address details provided by the DHCP server.
- If the IP Office does not receive a response from a DHCP server, it will configure itself as a DHCP server and use the following default address details:

Network Settings	LAN1	LAN2/WAN
IP address	192.168.42.1.	192.168.43.1
IP Mask	255.255.255.0	255.255.255.0
DHCP Mode	Server	Server
No of DHCP IP Addresses	200.	200.

If the IP address and DHCP mode settings are not suitable for the customers network they should be changed. Note that changing the IP Office's IP address settings requires it to restart.

- **! WARNING**
This process will require the IP Office system to reboot in order to complete the process. Any current calls and services will be ended by the reboot.

Changing IP Address Settings

- This option can not be done through [phone based administration](#) ⁵².
1. [Start Manager](#) ⁵⁰ and receive the configuration from the IP Office system.
 2. On the Manager home page, select Change System Settings (or from the Admin Tasks list select System).
 3. To use a fixed IP address, deselect Receive IP Address Via DHCP Server. Then in the IP Address (LAN1) and Sub-Net Mask (LAN1) fields, enter the required IP address settings.
 4. Click Apply.
 5. Click on the  save icon and save the updated configuration back to the IP Office system.

5.4 Changing the Default Passwords

At a minimum you should change the password used for IP Office configuration access. An IP Office system's [security settings can be set back to default](#) ^[110] if necessary using IP Office Manager.

- This process can be performed through [phone based administration](#) ^[52] from either of the first two systems in the system. For details, refer to the IP Office Essential Edition - Quick Version Phone Based Administration manual.

Changing the Remote Administration Password

This password controls remote and local access to the system using IP Office Manager. The default administration password is *password*.

- This option can be done through [phone based administration](#) ^[52] option #730.
 1. [Start Manager](#) ^[50] and receive the configuration from the IP Office system.
 2. On the Manager home page, select Change Remote / Administration Password. A log in dialog is displayed
 3. Provide login detail and enter password (case sensitive) as your password. The change dialog is displayed.
 4. Enter the new password and and click OK.

Changing the System Password

The system password is used from phones to authorize overriding night service and other settings such as call barring. If a system password is set, you must enter the system password before you can alter selected settings. By default no system password is set.

- This option can be done through [phone based administration](#) ^[52] option #403.
 1. [Start Manager](#) ^[50] and receive the configuration from the IP Office system.
 2. On the Manager home page, select Change System Settings (or from the Admin Tasks list select System).
 3. In the System Password field enter the password that should be used.
 4. Click Apply.
 5. Click on the  icon and save the updated configuration back to the IP Office system.

5.5 Extension Numbering

IP Office Essential Edition - Quick Version mode systems can use 2-digit or 3-digit numbering. In 2-digit systems, the user extensions are fixed as 10 to 57. In 3-digit systems the user extension are numbered 100 upwards by default but can be renumbered in the range 100 to 579.

In 2-digit mode, only 48 extensions are supported, in 3-digit mode a maximum of 100 extensions are supported. It is strongly recommended that these options are only used and changed on a newly installed system.

- This process can be performed through [phone based administration](#) ^[52] from either of the first two systems in the system. For details, refer to the IP Office Essential Edition - Quick Version Phone Based Administration manual.

Changing the Numbering Mode

1. Start Manager and receive the configuration from the IP Office system.
2. Select Tools | Extension Renumber.

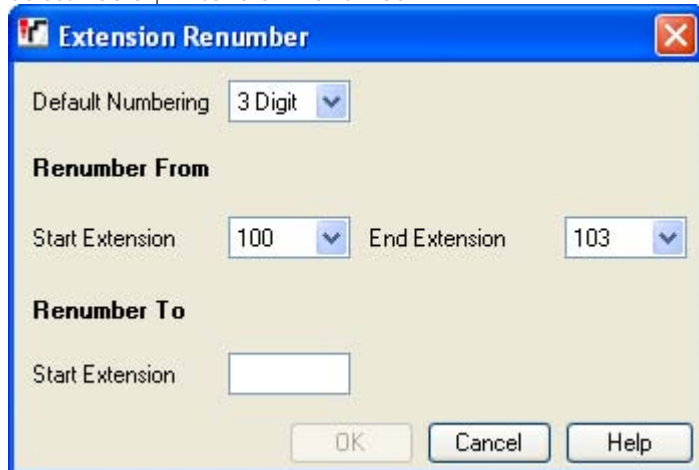

- **Default Numbering**
Select whether the systems uses 2 Digit or 3 Digit extension numbering. In 2 digit systems, the user extensions are fixed as 10 to 57. In 3 digit systems the user extension are numbered 100 upwards by default but can be renumbered. In 2 digit mode only 48 extensions are supported, in 3 digit mode a maximum of 100 extensions are supported.
- **Renumber From/Renumber To**
These options are available for systems set to 3 Digit numbering. They can be used to renumber select extensions.

3. Click on the save icon and save the updated configuration back to the IP Office system.

5.6 Entering Licenses

For IP500v2 control units, [license files can be pre-loaded](#) [61] onto the System SD card. Those [licenses](#) [21] will then be merged with the configuration when the control unit is powered up. Otherwise for all control units, licenses can be entered into the configuration using IP Office Manager. In addition to the methods below, license can also be added by placing the addition licenses as a [text file on the System SD card](#) [61].

You must ensure that the licenses being entered have been issue against the FK serial number of the System SD card fitted in the system. Each license is a unique 32-character string based on the feature being licensed and the serial number of the SD card plugged into the system control unit.

Entering licenses manually is liable to errors caused by miskeying the correct 32-character string.

Entering Licenses

- This option can not be done through [phone based administration](#) [52].
1. [Start Manager](#) [50] and receive the configuration from the IP Office system.
 2. From the Admin Tasks list select System and then License Management.
 - If the Admin Tasks list is not visible, select View and deselect Hide Admin Tasks.
 3. It is recommended that you use the Import control to import licenses from a file. Alternatively the license keys can be cut and pasted into the Key field.
 4. Click Apply.
 5. Click on the  save icon and save the updated configuration back to the IP Office system.
 6. Use Manager to receive the configuration again and check that the status of the license. It should now be *Valid*.



Chapter 6.

Additional Processes

6. Additional Processes

This section covers the following additional installation processes:

- [Switching Off an IP Office System](#) ⁹¹
- [Rebooting an IP Office System](#) ⁹²
- [Memory Card Removal](#) ⁹³
- [Changing Components](#) ⁹⁵
- [Upgrading the IP Office Software](#) ⁹⁷
- [Out of Building Extensions](#) ²⁶
- [Using the External Output Port](#) ¹⁰⁵
- [Reset Button Usage](#) ¹⁰⁶
- [AUX Button Usage](#) ¹⁰⁶
- [DTE Port Maintenance](#) ¹⁰⁷

6.1 Switching Off an IP Office System

IP Office systems running IP Office Release 6 can be shut down in order to perform maintenance. The shut down can be either indefinite or for a set period of time after which the IP Office will automatically reboot.

During the shut down process, the current configuration in the control unit's RAM memory is copied to the control units non-volatile memory. For IP500v2 systems that location is the System SD card.

For control units with memory cards the memory cards can be [shutdown and restarted](#)^[129] separately from the system.

! WARNINGS

- A shutdown must always be used to switch off the system. Simply removing the power cord or switching off the power input may cause errors.
- This is not a polite shutdown, any users calls and services in operation will be stopped. Once shutdown, the system cannot be used to make or receive any calls until restarted.
- The shutdown process takes up to a minute to complete. When shutdown, the CPU LED and the IP500 base card LEDs 1 and 9 (if trunk daughter card fitted) will flash red rapidly. The memory card LEDs are extinguished. Do not remove power from the system or remove any of the memory cards until the system is in the this state.
- To restart a system when shutdown indefinitely, or to restart a system before the timed restart, switch power to the system off and on again.

System Shutdown Using IP Office Manager

1. Using IP Office Manager, select File | Advanced | System Shutdown.
2. Using the Select IP Office menu, the System Shutdown Mode menu is displayed.

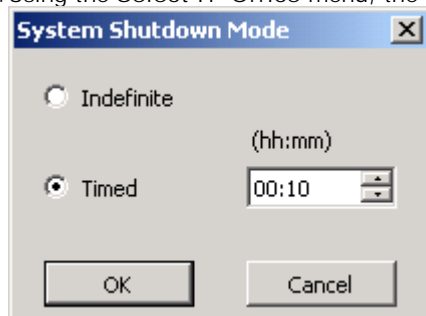

3. Select the type of shutdown required. If Indefinite is used, the system can only be restarted by having its power switched off and then on again. If a Timed shutdown is selected, the IP Office will reboot after the set time has elapsed.

System Shutdown Using the System Status Application

1. Start [System Status](#)^[57] and access the IP Office's status output.
2. In the navigation panel select System.
3. At the bottom of the screen select Shutdown System.
4. Select the time duration for the shutdown or indefinite.

System Shutdown Using the IP500v2 AUX Button

When the AUX button is pressed for more than 5 seconds, the IP500v2 control unit will shutdown with the restart timer set to 10 minutes.

6.2 Rebooting an IP Office System

You can use IP Office Manager to reboot an IP Office system.

1. Using IP Office Manager, select File | Advanced | Reboot.
2. Use the Select IP Office menu to locate and select the IP Office system. Enter a valid user name and password.
3. The type of reboot can then be selected.

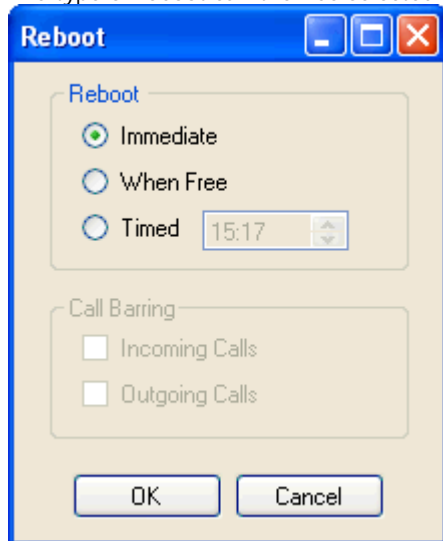

- Reboot
Select when the reboot should occur.
 - Immediate
Send the configuration and then reboot the IP Office.
 - When Free
Send the configuration and reboot the IP Office when there are no calls in progress. This mode can be combined with the Call Barring options.
 - Timed
The same as When Free but waits for a specific time after which it then wait for there to be no calls in progress. The time is specified by the Reboot Time. This mode can be combined with the Call Barring options.
- Reboot Time
This setting is used when the reboot mode Timed is selected. It sets the time for the IP Office reboot. If the time is after midnight, the IP Office's normal daily backup is canceled.
- Call Barring
These settings can be used when the reboot mode When Free is selected. They bar the sending or receiving of any new calls.

4. Click OK.

6.3 Memory Card Removal



Card Removal

Memory cards should always be [shutdown](#)^[129] before being removed when the system is running. Though the card slot LEDs indicate when data is being written to an card, lack of flashing LED is not a sufficient safeguard. Shutting down the card will disable embedded voicemail if being used. If the System SD card is removed, features licensed by the card's Feature Key serial number will continue operating for up to 2 hours.

Before a memory card is removed from an IP Office system that is running, the card must be shutdown. Removing a memory card while the system is running may cause file corruption.

Card services can be restarted by either reinserting the card or using a Start Up command.

Card Shutdown Using IP Office Manager

1. Using IP Office Manager, select File | Advanced | Memory Card Commands | Shutdown.
2. Using the Select IP Office menu, select the IP Office system containing the memory card.
3. Click OK.
 - At the back of the control unit, confirm that the appropriate memory card LED is off.
 - The card can now be removed in order to perform the necessary maintenance actions.

Card Shutdown Using the System Status Application Application

1. Start [System Status](#)^[57] and access the IP Office's status output.
2. In the navigation panel select System.
3. Select Memory Cards.
4. Select either System Card or Optional Card.
5. At the bottom of the screen select Shutdown.
 - At the back of the control unit, confirm that the appropriate memory card LED is off.
 - The card can now be removed in order to perform the necessary maintenance actions.

Card Reinsertion

Reinserting a memory card into a system that is already switched on will automatically restart card operation. However, if the card has been shutdown but not removed, it can be restarted using Manager without requiring a reboot.

Card Startup Using IP Office Manager

1. Using IP Office Manager, select File | Advanced | Memory Card Commands | Startup.
2. Using the Select IP Office menu, select the IP Office system containing the memory card.
3. Click OK.

Card Startup Using the System Status Application

3. Start [System Status](#)  and access the IP Office's status output.
4. In the navigation panel select System.
3. Select Memory Cards.
4. Select either System Card or Optional Card.
5. At the bottom of the screen select Start Up.

6.4 Changing Components

Except for memory cards (see [Memory Card Removal](#)^[93]), cards and external expansion modules must only be removed and added to an IP Office system when that system is [switched off](#)^[91].

In the sections below, the term component can refer to a card fitted into the IP Office or an external expansion module.

Note that for extension ports, by default both an extension entry and a user entry will exist in the IP Office configuration. Extension entries can be deleted without deleting the corresponding user entry. This allows retention of the user settings and association of the user with a different extension by changing that extensions Base Extension number to match the user's Extension ID.

Like for Like Replacement

If replacing with a component of the same type no configuration changes are necessary.

1. [Switch off the IP Office system](#)^[91].
2. Remove the card or external expansion module. Note the card slot or expansion port used as the replacement must be installed in the same position.
3. Install the replacement using the appropriate process for the type of component ([Fitting IP500 cards](#)^[62], [Adding External Expansion Modules](#)^[71]).
4. Restart the IP Office system.

Higher Capacity Replacement

If replacing with a component of the same type but higher capacity, when restarted the IP Office will automatically create configuration entries for the new trunks or extensions/users.

1. [Switch off the IP Office system](#)^[91].
2. Remove the card or external expansion module. Note the card slot or expansion port used as the replacement must be installed in the same position.
3. Install the replacement using the appropriate process for the type of component ([Fitting IP500 cards](#)^[62], [Adding External Expansion Modules](#)^[71]).
4. Restart the IP Office system.
5. Use Manager to configure the new trunks or extensions/users.

Lower Capacity Replacement

If replacing with a component of the same type but lower capacity, after restarting the IP Office the configuration will need to be edited to remove redundant entries.

1. [Switch off the IP Office system](#)^[91].
2. Remove the card or external expansion module. Note the card slot or expansion port used as the replacement must be installed in the same position.
3. Install the replacement using the appropriate process for the type of component ([Fitting IP500 cards](#)^[62], [Adding External Expansion Modules](#)^[71]).
4. Restart the IP Office system.
5. Use Manager to delete the trunks or extensions/users in the configuration that are no longer supported by the component installed.

Adding a New Component

If adding a new component to an available slot or port, when restarted the IP Office will automatically create configuration entries for the new trunks or extensions/users.

1. [Switch off the IP Office system](#) ^[91].
2. Install the replacement using the appropriate process for the type of component ([Fitting IP500 cards](#) ^[62], [Adding External Expansion Modules](#) ^[71]).
3. Restart the IP Office system.
4. Use Manager to configure the new trunks or extensions/users.

Permanent Removal

If permanently removing the component, the configuration will need to be edited to remove redundant trunk or extension/user entries.

1. [Switch off the IP Office system](#) ^[91].
2. Remove the card or external expansion module.
3. Restart the IP Office system.
4. Use Manager to delete the trunks or extensions/users in the configuration that relate to the component removed.
5. In the Control Unit section of the configuration, delete the entry for the component that is no longer present in the system.

Replacement of a Different Type

If replacing a component with one of a different type, the process should be divided into two stages. First remove the existing component using the Permanent Removal process above and adjust the configuration and reboot. Then install the new component using the Adding a New Component process above.

6.5 Upgrading the IP Office Software

The installed IP Office Manager includes IP Office software files for control units, external expansion modules and phones appropriate to the IP Office software level.

- **New IP500v2 Systems**
For the first 90 days, a new IP500v2 control unit will run any supported IP Office Release without requiring an upgrade license. The highest level run is written into the system's memory (not the SD card) and that becomes a permanent entitlement for the control unit. However, after 90 days the IP500v2 will require an upgrade license if upgraded to a software release higher than any that it has run in the initial 90 day period.
-  **Warning**
Systems upgraded without the appropriate license will display *"No license available"* and will not allow any telephony functions.

The IP Office system can be upgraded in two ways:

- [Using the IP Office Manager Upgrade Wizard](#)^[98]
The upgrade wizard is part of IP Office Manager and can be used to upgrade all types of IP Office system.
- [Upgrading the System SD Card](#)^[100]
For IP500v2 control units, the software on the System SD card can be upgraded by a range of methods, i.e. directly upgrading the SD card or using the upgrade wizard. When the system is rebooted it will use the new software.



WARNINGS

- **Check IP Office Technical Bulletins**
Check the latest IP Office Technical Bulletin for the IP Office software release before proceeding any further. It may contain information relating to changes that occurred after this document was completed. Bulletins are available from <http://support.avaya.com>.
- **Upgrade Path/Multi-Stage Upgrades**
Due to the need to adjust internal memory allocation and configuration storage, for some upgrades the control unit may need to perform multi-stage upgrade process. The table below indicates the require upgrade paths.

Platform	Current Release	Upgrade Step 1
IP500	4.0 / 4.1 / 4.2 / 5.0	Load 7.0
IP500v2	6.0	Load 7.0
All modules	4.0 / 4.1 / 4.2 / 5.0	Load 7.0

- **Multiple Managers**
If more than one copy of Manager is running it is possible for the IP Office to request BIN files from a different Manager from the one that started the upgrade process. Ensure that only one copy of Manager is running when upgrading an IP Office system.
- **Other IP Office Applications**
Upgrading the core software of the IP Office control unit may require upgrades to associated software. Typically IP Office is compatible with the previous release of most IP Office applications, however for each IP Office core software release there may be exceptions. These exceptions will be detailed in the Technical Bulletin for the IP Office core software release.

6.5.1 Using the Upgrade Wizard

1. Ensure that you have a backup copy of the IP Office's configuration before performing this action. If a copy of the configuration cannot be downloaded using Manager, check the Manager application directory for previously downloaded configurations.
 - a. Use Manager to download an up to date copy of the configuration. If that is not possible, check in the Manager application folder for a previous copy of the configuration.
 - b. Using IP Office Manager, select File | Open Configuration.
 - c. Using the Select IP Office Menu, locate and select the IP Office system. Click OK.
 - d. Enter the name and password for a service user account on that IP Office. Click OK. Manager will receive and display the configuration from the IP Office.
 - If not already done, this action creates a BOOTP entry in Manager for the IP Office system.
 - This action also confirms communication between the Manager PC and the IP Office prior to any following process.
 - e. Select File | Save Configuration As... and save a copy of the configuration file onto the PC.
2. Select File | Advanced | Upgrade. The UpgradeWiz is started and scans for IP Office modules using the Unit/Broadcast address. Adjust this address and click Refresh if the expected control units are not shown.

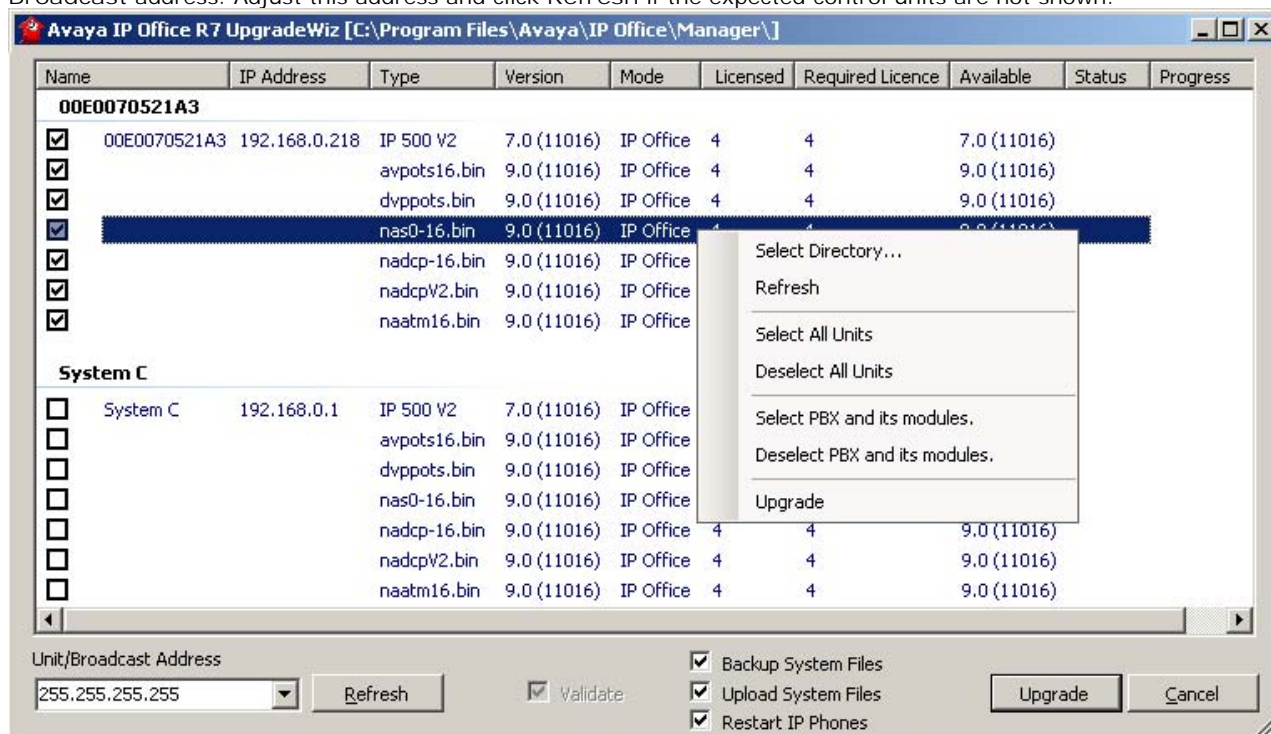



2. The information displayed depends on the type of control unit.
 - For IP500v2 control units
The current version of each IP Office .bin file held in the control units memory is shown. That is regardless of whether that .bin file is currently being used by any module in the system.
 - For other control units
For the control unit and each external expansion module present in the system, the current version of software installed is displayed.
3. The Version column indicates the current version of software installed. The Available column indicates the version of software Manager has available. If the available version is higher, the check box next to that row is automatically selected.
 - If any of the modules have pre-version 2.1 software installed, an upgrade with Validate unticked is required. If this is the case, only continue with the upgrade process using a PC with a fixed IP address on the same LAN domain and physical LAN segment as the IP Office control unit and only upgrade the pre-2.1 system.
 - If a multi-stage upgrade is necessary, use the following additional steps to select the appropriate interim software:
 - Right-click on the upgrade wizard and click Select Directory. Locate and select the directory containing the bin file for the intermediate software level.
 - The upgrade wizard should now list just the control unit as having upgrade software available.

- Upgrading to particular levels of IP Office software require a *Software Upgrade X* license where *X* is a number. The Licensed and Required License columns indicate the current highest upgrade license the system has and the required software upgrade license for the currently installed software. It does not indicate the license requirement for the level of software in the Available column. For IP500v2 systems, a value of 255 indicates that the control unit is still in its initial 90 days where it can be upgraded without requiring a license.
4. For those modules which you want to upgrade, tick the check box.
 5. For IP500v2 control units, the following additional options are available:
 - **Backup System Files**
If selected, before upgrading to the new software, the current files in the System SD cards /primary folder will be copied to its /backup folder.
 - **Upload System Files**
If selected, the full set of software files that Manager has is copied to the /primary folder on the System SD card. In addition to control unit and module software this will include phone software files. Following the reboot, the phone will upgrade using those files if necessary.
 - **Restart IP Phones**
If selected, following the upgrade and reboot, all Avaya IP phones are also restarted. This will cause them to recheck whether the firmware they currently have loaded matches that on their configured file server. Use this option if the IP Office system is the file server and the upgrade included new IP phone firmware.
 6. Select Upgrade. The system password for each system will be requested. Enter it and click OK. The next steps depend on the upgrade options selected. Do not cancel or close the upgrade wizard while these processes are running.
 - **Validated Upgrade**
If using the Validated option, a number of actions take place as follows:
 - a. The upgrade wizard checks the amount of free RAM memory available in the control unit to temporarily store the new BIN files. If insufficient memory is available, you will be prompted whether to continue with an off-line upgrade or cancel upgrading.
 - If offline is selected, the IP Office is rebooted into offline mode. It may be necessary to use the Refresh option within the Upgrade Wizard to reconnect following the reboot. Validate upgrade can then be attempted to again check the amount of available RAM memory for transfer of BIN files. If the memory is still insufficient, the option is offered to either do an unvalidated upgrade or cancel.
 - b. The bin files required are transferred to the system and stored in temporary memory.
 - c. For IP500v2 control units, the backup system files and upload system files actions are performed.
 - d. Once all file transfers are completed, the upgrade wizard will prompt whether it okay to proceed with the upgrade process. Select Yes to continue.
 - e. Each module being upgraded will delete its existing core software, restart and load the new software file that was transferred. This process may take several minutes for each unit.
 - **Unvalidated Upgrade**
This method of upgrading should be avoided unless absolutely necessary. It is only required for IP Office systems with pre-2.1 software and should only be done from a Manager PC with a fixed IP address running on the same LAN segment and subnet as the IP Office system. During the upgrade the units and modules erases their current software and then request the new software file from Manager.
 7. Following the upgrade check that the upgrade wizard now shows that the selected units and modules have upgraded. It may be necessary to select Refresh to update the information in the upgrade wizard display.
 8. Repeat the process as required.

6.5.2 Using an SD Card

In addition to using the traditional [IP Office Upgrade Wizard](#)¹⁹⁸, IP500v2 control units can be upgraded by loading the required set of firmware files onto the System SD card and rebooting the system.

-  IP Office Technical Bulletins
Ensure that you have obtained and read the IP Office Technical Bulletin relating to the IP Office software release which you are installing. This bulletin will contain important information that may not have been included in this manual. IP Office Technical Bulletins are available from the [Avaya support](http://support.avaya.com) website (<http://support.avaya.com>).
-  Upgrade Licenses
Some upgrades may require entry of upgrade licenses.
- **! WARNING**
This process will require the IP Office system to reboot in order to complete the process. Any current calls and services will be ended by the reboot.

There are a number of ways in which this can be done.

Method	Description	Location	Software Files	Embedded Voicemail Prompts
Using Manager ¹²⁷	Using IP Office Manager, the contents of the card are compared to the files that Manager has available and are upgraded if necessary.	Local or Remote	✓	✓
System SD Card Upgrade ¹²⁷	In this method, the System SD card is shut down and removed from the control unit. The card's contents are upgraded using IP Office Manager.	Local	✓	✓
Upgrade from Optional SD Card ¹²⁸	This method uses an SD card loaded with the required version of IP Office software. The card is inserted into the control unit's Option SD card slot and its contents copied to the System SD card.	Local	✓	–

6.6 Out of Building Telephone Installations

The following are the only supported scenarios in which wired extensions and devices outside the main building can be connected to the IP Office system. In these scenarios, additional protection, in the form of protective grounding and surge protectors, must be fitted.

-  **WARNING**
 The fitting of additional protection does not remove the risk of damage. It merely reduces the chances of damage.

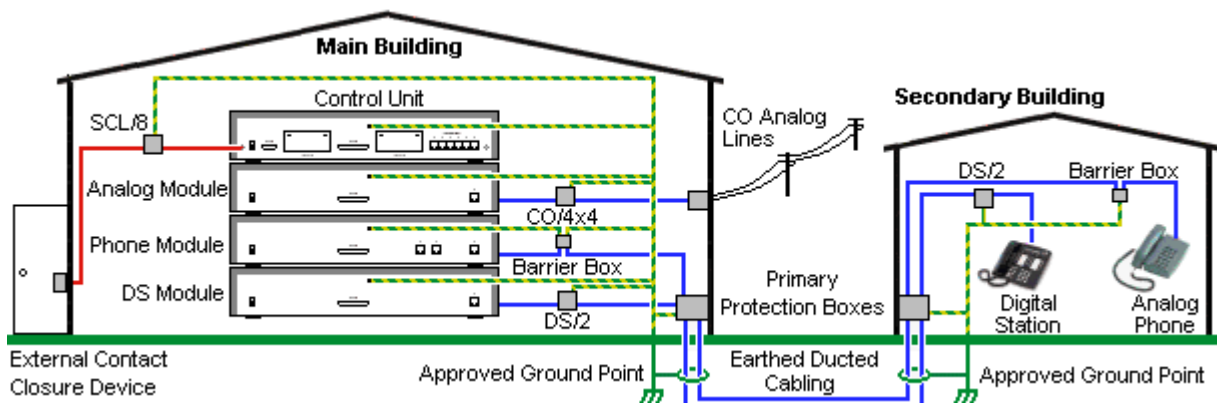

- Cables of different types, for example trunk lines, phone extensions, ground and power connections, should be kept separate.
- All cabling between buildings should be enclosed in grounded ducting. Ideally this ducting should be buried.
- A Primary Protection Box must be provided at the point where the cables enter the building. This should be three point protection (tip, ring and ground). Typically this would be gas tube protection provided by the local telephone company. The ground wire must be thick enough to handle all the lines being affected by indirect strike at the same time.

Connection Type	Protection Device Type	Requirement
Analog Phone Extensions Phones External expansion module (POT ^[20b] or PHONE ^[20b]) ports only.	IP Office Barrier Box ^[10b] Supports a single connection. Maximum of 16 on any expansion module.	<ul style="list-style-type: none"> Connection from the expansion module to the phone must be via a surge protector at each end and via the primary protection point in each building. The IP Office expansion module and control unit and IROB devices must be connected to the protective ground point in their building.
DS Phone Extensions External expansion module DS ^[20b] ports only.	ITWLinx towerMAX DS/2 ^[10b] Supports up to 4 connections. (This device was previously referred to as the Avaya 146E).	<ul style="list-style-type: none"> The between building connection must be via earthed ducting, preferable underground. The cable must not be exposed externally at any point.
TCM Phone Extensions	None	Currently not supported.
Analog Trunks	ITWLinx towerMAX CO/4x4 ^[10b] Supports up to 4 two-wire lines. (This device was previously referred to as the Avaya 146C).	<p>For installations in the Republic of South Africa, the fitting of surge protection on analog trunks is a requirement.</p> <p>For other locations where the risk of lightning strikes is felt to be high, additional protection of incoming analog trunks is recommended.</p>
External Output Switch	ITWLinx towerMAX SCL/8 (This device was previously referred to as the Avaya 146G)	Connections from an IP Office Ext O/P port to an external relay device must be via a surge protector.

The towerMAX range of devices are supplied by ITWLinx (<http://www.itwlinx.com>).

6.6.1 DS Phones

When digital phone extensions are required in another building, additional In-Range Out-Of-Building (IROB) protective equipment must be used. For phones connected to IP Office [DS₂₀₀](#) ports, the supported device supplied by ITWLinx is a towerMAX DS/2 module. This IROB device was previously badged by Avaya as the 146E IROB.

- **! WARNING**
This device is not supported for TCM port connections, ie. 4100 Series, T-Series, 7400 Series and M-Series phones.
- Only DS connections on an external expansion module are supported. DS ports on cards in the control unit should not be used.

The protection device should be installed as per the instructions supplied with the device. The ground points on the IP Office control unit and the DS modules must be connected to a protective ground using 18AWG wire with a green and yellow sleeve.

Typically the IROBs 2 RJ45 EQUIPMENT ports are straight through connected to the 2 RJ45 LINE ports. This allows existing RJ45 structured cabling, using pins 4 and 5, to be used without rewiring for up to two DS connections. However each of these ports can be used to connect a second extension using pins 3 and 6.

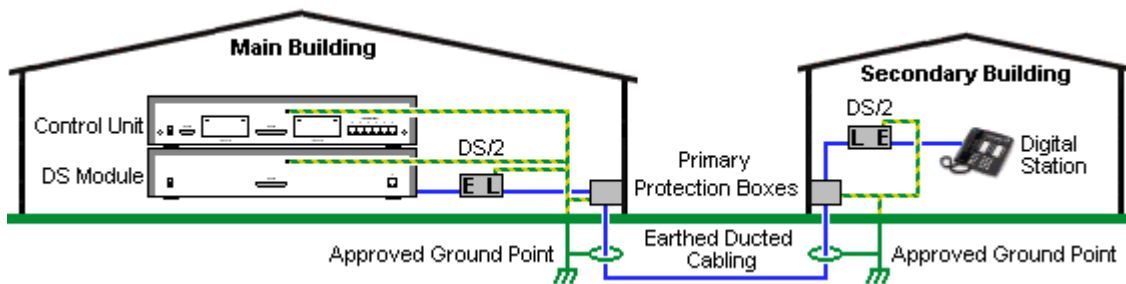

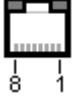
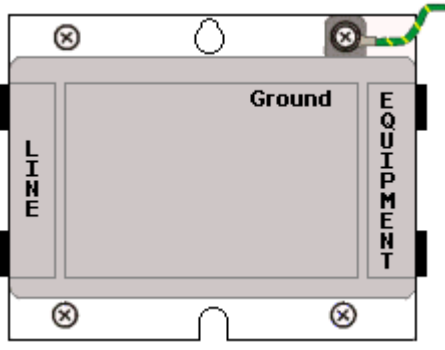
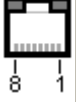
LINE	Signal	EQUIPMENT
 8 1	1	Not used.
	2	Not used.
	3	Ring II (Optional)
	4	Ring I
	5	Tip I
	6	Tip II (Optional)
	7	Not used.
	8	Not used.
		 8 1

6.6.2 Analog Phone Barrier Box

Where analog phone extensions are required in another building, additional protective equipment must be used, in the form of IP Office Phone Barrier Boxes and protective earth connections.

-  **CAUTION**
PHONE (POT) ports on the front of control units must not be used for extensions that are external to the main building.
- The correct IP Office specific barrier boxes must be used. These modules have been designed specifically for the signalling voltages used by the IP Office system:
 - Only the IP Office Phone Barrier Box should be used with Phone V1 modules.
 - Only the IP Office Phone Barrier Box V2 should be used with Phone V2 modules.
 - No other type of analog phone barrier box should be used.
- Where more than 3 barrier boxes are required in a building, they must be rack mounted using a [Barrier Box rack mounting kit](#) ⁽¹⁰⁴⁾.
- A maximum of 16 barrier boxes can be used with any Phone module.
- The Phone Barrier Box does not connect the ringing capacitor in Phone V1 modules.

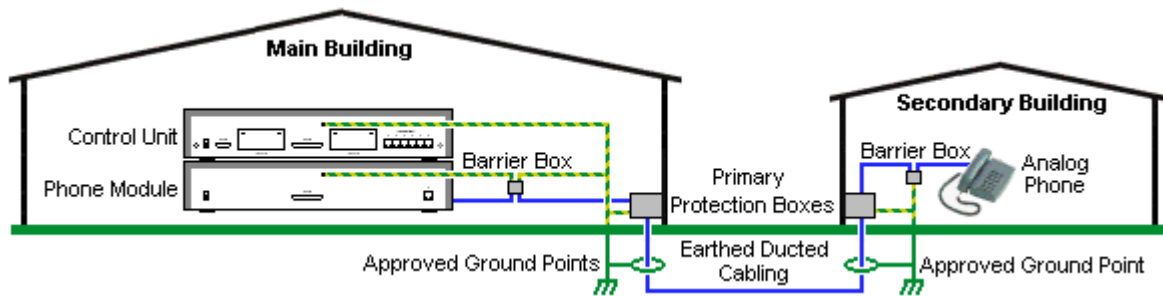

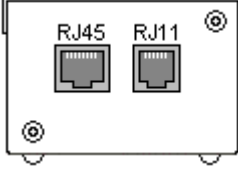
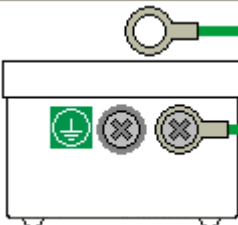
Main Building	Barrier Box	Secondary Building
<ul style="list-style-type: none"> • RJ11 Connect to PHONE (POT) port on the Phone module using cable supplied with the barrier box. • RJ45 Connect to the secondary building barrier box via primary protection in both buildings. 		<ul style="list-style-type: none"> • RJ11 Connect to analog phone. Cable not supplied. • RJ45 From main building via primary protection in both buildings.
<ul style="list-style-type: none"> • Center Screw Connect to main building protective ground (or ground terminal of Barrier Box Rack Mounting Kit). Use 18AWG (minimum) wire with a green and yellow sleeve. • Right-Hand Screw Connect to ground point on Phone module using ground cable supplied with barrier box. 		<ul style="list-style-type: none"> • Center Screw Connect to main building protective ground. Use 18AWG (minimum) wire with a green and yellow sleeve. • Right-Hand Screw Not used.

1. The following wires must be kept apart, that is not routed in the same bundle:
 - Earth leads from the barrier box to the Phone modules.
 - Internal wires, for example extension leads going directly to the Phone modules.
 - Wires from external telephone going directly to the barrier boxes.

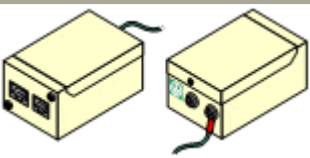
IP Office Barrier Boxes	SAP Code
 <p>IP400 Phone Barrier Box (81V) Use with Phone V1 module. Includes an RJ45 to RJ11 cable and a functional earth lead.</p>	700293897
<p>IP400 Phone Barrier Box V2 (101V) Use with Phone V2 module. Includes an RJ45 to RJ11 cable and a functional earth lead.</p>	700385495
Barrier Box Rack Mounting Kit	700293905

6.6.3 Rack Mounting Barrier Boxes

Where more than 3 Phone Barrier Boxes are used they must be rack mounted. The Barrier Box Rack Mounting Kit (SAP Code 700293905) supports up to 8 Phone Barrier Boxes.

1. Unscrew the two screws arranged diagonally at the front of each barrier box and use these same screws to reattach the barrier box to the rack mounting strip.
2. Each barrier box is supplied with a solid green ground wire connected to its functional ground screw. Remove and discard this wire. Connect a green/yellow ground wire to the protective earth screw in the center of the Point on the back of the Barrier Box.

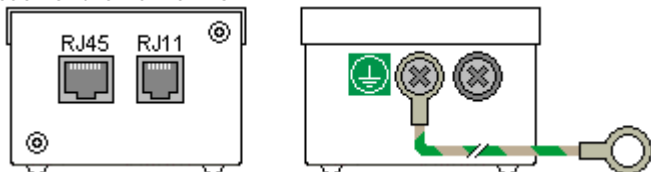

3. The rack mounting strip has threaded M4 earthing pillars. Connect the other end of the barrier box ground wire, using M4 washers and nuts, to the earthing pillar on that side of the rack mounting strip.

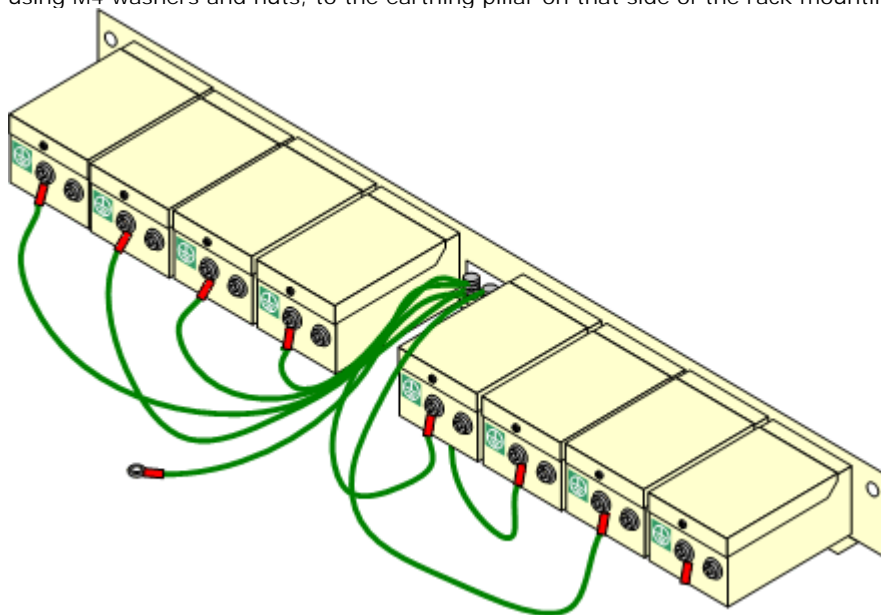

4. Using 14AWG wire with green and yellow sleeve, connect one of the earthing pillars to the buildings protective earth.
5. Using 14AWG wire with green and yellow sleeve, connect the other earthing pillar to the Phone module.
6. Ensure that the following wires are not routed together in the same bundle:
 - Earth lead from the barrier box to the Phone module.
 - Internal wires, e.g. wires going directly to the Phone module.
 - Wires from external telephone going directly to the barrier boxes.

6.7 Using the External Output Port

All the IP Office control units are equipped with a EXT O/P port. The port is marked as EXT O/P and is located on the back of the control unit adjacent to the power supply input socket.

The port can be used to control up to two external devices such as door entry relay switches. The usual application for these switches is to activate relays on door entry systems. However, as long as the criteria for maximum current, voltage and if necessary protection are met, the switches can be used for other applications.

The switches can be switched closed, open or pulsed (closed for 5 seconds and then open). This can be done in a number of ways:

- Using IP Office short codes.
- Through the Door tab in Phone Manager Pro.
- Through the Door Release option in IP Office SoftConsole.
- Via the Open Door action in Voicemail Pro.

Default Short Codes

The following are the default short codes in the IP Office configuration for external output switch operation. They use the short code features Relay On (closed), Relay Off (open) and Relay Pulse.

State	Switch 1	Switch 2
Closed	*39	*42
Open	*40	*43
Pulse	*41	*44

6.7.1 Port Connection

These ports are found on the rear of all IP Office control units. They are used for connection to external switching relays. The port uses a standard 3.5mm stereo jack plug for connection.

The IP Office is able to open (high resistance), close (low resistance) or pulse (close for 5 seconds and then open) two switches within the port. Either switch can be operated separately. These switches are intended for activation of external relays in systems such as door opening systems.

- CAUTION: In installations where this port is connected to a device external to the building, connection must be via a towerMAX SCL/8 Surge Protector and a protective ground connection must be provided on the IP Office control unit.

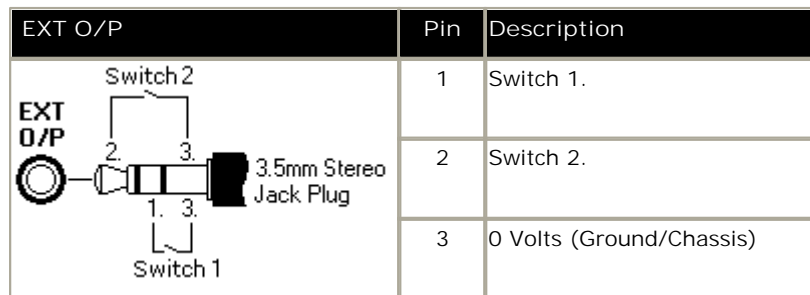

- Switching Capacity: 0.7A.
- Maximum Voltage: 55V d.c.
- On state resistance: 0.7 ohms.
- Short circuit current: 1A.
- Reverse circuit current capacity: 1.4A.
- Ensure that pins 1 and 2 are always at a positive voltage with respect to pin 3.

3.5mm stereo audio jack plugs are frequently sold as pre-wired sealed modules. It may be necessary to use a multi-meter to determine the wiring connections from an available plug. Typically 3 (common to both relays) is the cable screen.

6.8 Reset Button

The IP500 and IP500v2 control units have a Reset button. Pressing the button while the control unit is starting up will pause the start up until the button is released. The effect of pressing the button during normal operation will depend on how long the button is pressed and is indicated by the CPU LED.

Press Duration (seconds)	CPU LED	Action	Summary
0 to 5.	Off	None	None.
5 to 10.	Orange	Reboot When Free	Reboot when free with new incoming/outgoing call barring. A reboot using the reset button is recorded in the Audit Trail.
10 to 30.	Flashing orange	Erase Configuration/ Immediate Reboot	Erase the configuration, alarm log and audit trail. Immediate reboot without waiting for active calls to end. See Erasing the configuration for full details.
30 to 40.	Red	Erase All.	Erase configuration, alarm log and core software. See Erasing the Operational Software for full details.
Over 40.	Flashing green	None	None.

6.9 AUX Button

IP500v2 control units have an AUX button. This button can be used as follows.

If pressed during a restart of the control unit, the control unit [skip booting](#) from the `/primary` folder on the System SD card. If pressed for more than 5 seconds when a system is running, the control unit will [shutdown](#) for 10 minutes.

6.10 DTE Port Maintenance

The DTE port on the back of IP Office control units is not normally used when configuring an IP Office system. However, in extreme cases, the DTE port can be used to default the system's configuration or to erase its core software if necessary.

- ⚠ **WARNING**
 Due to the nature of the actions in this section, they should only be performed if absolutely necessary to return a system back to working order. In all cases, you must make every effort to ensure that you have a backup copy of the system configuration.
- The DTE ports on IP Office expansion modules are not used for any maintenance or diagnostics.

6.10.1 DTE Port Settings

These ports are found on the rear of all IP Office control units and external expansion modules. The DTE ports on external expansion modules are not used.

The RS232 DTE ports on the control units can be used for system maintenance and connection of serial terminal adaptors. On IP400 control units the port can also be used for connection of the IP Office serial port licence key dongle.

An asynchronous terminal program such as HyperTerminal is also required. Configure this for operation via a PC serial port, as follows:

Bits per second	38,400	Parity	None	Flow Control	None
Data bits	8	Stop Bits	1	Settings Emulation	TTY

DTE Cables

These cables are used for system maintenance and diagnostics under Avaya guidance. They can also be used for connection of RS232 serial terminal adaptor equipment to the IP Office control unit. The cable required depends on the IP Office control unit. This cable is a "Straight through DB9 female to DB9 male serial cable".

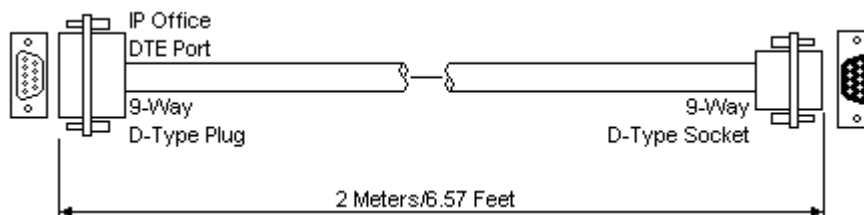

IP Office 9-Way RS232 DTE Port	Signal	PC/Terminal Adaptor
3	← Receive data	3
2	→ Transmit Data	2
7	← RTS (Request To Send)	7
8	→ CTS (Clear To Send)	8
6	→ DSR (Data Set Ready)	6
5	■ Ground	5
1	→ DCD (Data Carrier Detect)	1
4	← DTR (Data Terminal Ready)	4
9	→ RI (Ring Indicator)	9

6.10.2 Erasing the Configuration

The following processes erases the configuration held in the IP Office control unit's memory. That include both the current configuration being used in RAM memory and the backup configuration stored in non-volatile memory. Following this the IP Office will restart with a default configuration.

This process should be performed from a PC with a fixed IP address, directly connected to the IP Office control unit and with the IP Office system disconnected from any network. Following this process, the control unit's IP address will default to 192.168.42.1.

-  Do not perform any of these processes unless absolutely necessary. The IP Office's configuration settings can be default through Manager using the File | Advanced | Erase Configuration command.
- For IP Office Release 7.0 and higher, IP500v2 systems using IP Office A-Law or IP Office Mu-Law System SD cards will default to IP Office Essential Edition - Quick Version mode. Loading the configuration will switch IP Office Manager to simplified view. To change the system back to operating in IP Office Standard Version mode, select the File | Advanced | Change Mode.

Erasing the Configuration via Debug

This process erases the IP Office's configuration settings but does not alter its security settings. It is easier to use than the boot loader method.

1. Ensure that you have a backup copy of the IP Office's configuration before performing this action. If a copy of the configuration cannot be downloaded using Manager, check the Manager application directory for previously downloaded configurations.
 - a. Use Manager to download an up to date copy of the configuration. If that is not possible, check in the Manager application folder for a previous copy of the configuration.
 - b. Using IP Office Manager, select File | Open Configuration.
 - c. Using the Select IP Office Menu, locate and select the IP Office system. Click OK.
 - d. Enter the name and password for a service user account on that IP Office. Click OK. Manager will receive and display the configuration from the IP Office.
 - If not already done, this action creates a BOOTP entry in Manager for the IP Office system.
 - This action also confirms communication between the Manager PC and the IP Office prior to any following process.
 - e. Select File | Save Configuration As... and save a copy of the configuration file onto the PC.
2. Attach the serial cable between the PC and the DTE port on the IP Office control unit.
 - a. Start the terminal program on your PC. Ensure that it has been setup as listed in [DTE Port Settings](#)⁽¹⁰⁷⁾. Within a HyperTerminal session, the current settings are summarized across the base of the screen.
 - b. Enter AT (note upper case). The control unit should respond *OK*.
 - c. Enter AT-DEBUG. The control unit should response with the time and date and then *Hello>* to show it is ready to accept commands.
3. To erase the current configuration in RAM memory enter *eraseconfig*. The *Hello>* command prompt reappears when the action is completed.
4. To erase the backup configuration stored in non-volatile Flash memory enter *erasenvconfig*. The *Hello>* command prompt reappears when the action is completed.
5. To reboot the IP Office enter *reboot*. The IP Office will reboot and restart with a defaulted configuration.
6. Close the terminal program session.
7. Manager can now be used to alter and then upload an old configuration file or receive and edit the control unit's now defaulted configuration.

Erasing the Configuration and Security Settings via the Boot Loader

This process defaults the IP Office security settings and its configurations settings.

2. Ensure that you have a backup copy of the IP Office's configuration before performing this action. If a copy of the configuration cannot be downloaded using Manager, check the Manager application directory for previously downloaded configurations.
 - f. Use Manager to download an up to date copy of the configuration. If that is not possible, check in the Manager application folder for a previous copy of the configuration.
 - g. Using IP Office Manager, select File | Open Configuration.
 - h. Using the Select IP Office Menu, locate and select the IP Office system. Click OK.
 - i. Enter the name and password for a service user account on that IP Office. Click OK. Manager will receive and display the configuration from the IP Office.
 - If not already done, this action creates a BOOTP entry in Manager for the IP Office system.
 - This action also confirms communication between the Manager PC and the IP Office prior to any following process.
 - j. Select File | Save Configuration As... and save a copy of the configuration file onto the PC.
2. Attach the serial cable between the PC and the DTE port on the IP Office control unit.
 - a. Start the terminal program on your PC. Ensure that it has been setup as listed in [DTE Port Settings](#)^[107]. Within a HyperTerminal session, the current settings are summarized across the base of the screen.
 - b. Arrange the program windows so that the Terminal program and Manager TFTP Log are visible at the same time.
 - c. Switch off power to the IP Office control unit.
 - d. Power on the control unit and press the escape key every second until you get a Loader message. Below is an example.

```
P12 Loader 2.4
CPU Revision 0x0900
```
 - e. Enter AT (note upper case). The control unit should respond *OK*.
 - f. If an OK response is not received, check the settings of your terminal program and repeat the process above.
3. Proceed with the erasure process.
 - To erase the alarm log enter *AT-X1*.
 - To erase the current configuration, enter *AT-X2*. A typical response is *Sector 2 Erase (NV Config)* followed by *OK*. Enter *AT-X3*. A typical response is *Sector Erases (Config)* followed by a series of *OK* responses.
4. Switch power to the control unit off and then back on. Within the terminal program you should see various messages as the control unit performs various start up tasks.
5. Close the terminal program session.
6. Manager can now be used to alter and then upload an old configuration file or receive and edit the control unit's now defaulted configuration.

6.10.3 Defaulting Security Settings

Procedure: Defaulting Security Settings

This process defaults the IP Office's security settings but does not alter its configuration settings.

1. Attach the serial cable between the PC and the DTE port on the IP Office control unit.
2. Start the terminal program on your PC. Ensure that it has been setup as listed in [DTE Port Settings](#)^[107]. Within a HyperTerminal session, the current settings are summarized across the base of the screen.
3. Enter AT (note upper case). The control unit should respond *OK*.
4. Enter AT-SECURITYRESETALL.
5. You will be prompted to confirm the control unit's MAC address before continuing. Enter the address.
6. The control unit will respond *OK* when the action has been completed.
7. Close the terminal program session.
8. Manager can now be used to receive and edit the control unit's now defaulted security settings.

Defaulting the Configuration and Security Settings via the Boot Loader

This process defaults the IP Office security settings and its configurations settings.

1. Ensure that you have a backup copy of the IP Office's configuration before performing this action. If a copy of the configuration cannot be downloaded using Manager, check the Manager application directory for previously downloaded configurations.
 - a. Use Manager to download an up to date copy of the configuration. If that is not possible, check in the Manager application folder for a previous copy of the configuration.
 - b. Using IP Office Manager, select File | Open Configuration.
 - c. Using the Select IP Office Menu, locate and select the IP Office system. Click OK.
 - d. Enter the name and password for a service user account on that IP Office. Click OK. Manager will receive and display the configuration from the IP Office.
 - If not already done, this action creates a BOOTP entry in Manager for the IP Office system.
 - This action also confirms communication between the Manager PC and the IP Office prior to any following process.
 - e. Select File | Save Configuration As... and save a copy of the configuration file onto the PC.
2. Attach the serial cable between the PC and the DTE port on the IP Office control unit.
 - a. Start the terminal program on your PC. Ensure that it has been setup as listed in [DTE Port Settings](#)^[107]. Within a HyperTerminal session, the current settings are summarized across the base of the screen.
 - b. Arrange the program windows so that the Terminal program and Manager TFTP Log are visible at the same time.
 - c. Switch off power to the IP Office control unit.
 - d. Power on the control unit and press the escape key every second until you get a Loader message. Below is an example.



```
P12 Loader 2.4
CPU Revision 0x0900
```
 - e. Enter AT (note upper case). The control unit should respond *OK*.
 - f. If an OK response is not received, check the settings of your terminal program and repeat the process above.
3. To erase the current configuration in RAM memory enter AT-X3. A typical response is *Sector Erases (Config)* followed by a series of *OK* responses.
4. To erase the backup configuration stored in non-volatile memory enter AT-X2. A typical response is *Sector 2 Erase (NV Config)* followed by *OK*. IP Office 403 only: If running an IP Office 403 control unit, also enter AT-X4.
5. Switch power to the control unit off and then back on. Within the terminal program you should see various messages as the control unit performs various start up tasks.
6. Close the terminal program session.
7. Manager can now be used to alter and then upload an old configuration file or receive and edit the control unit's now defaulted configuration.

6.10.4 Erasing the Operational Firmware

When the firmware loaded by the control unit is erased, the control unit will begin making BOOTP requests for a replacement firmware file. Manager can act as a BOOTP server and respond to the control units request with the appropriate file from those installed with Manager.

Unlike other control units, when the firmware loaded by an IP500v2 control unit is erased, the IP500v2 control unit will first look for replacement firmware on its SD cards before falling back to using a BOOTP request to Manager.

The processes below should be performed from a PC with a fixed IP address, directly connected to the IP Office control unit and with the IP Office system disconnected from any network. During the process, the control unit's IP address may default to a value in the 192.168.42.1 to 192.168.42.10 range. If this occurs, it may be necessary to amend the BOOTP entry in IP Office Manager to match the address the system is using.

-  Do not perform any of the following processes unless absolutely necessary. The IP Office software can normally be [upgraded using IP Office Manager](#)^[97].
-  This process erases the operational software. Before attempting this process you must know the MAC and IP addresses of the system, plus have a backup copy of its configuration and the correct .bin file for the control unit type and level of software.
-  The presence of any firewall blocking TFTP and or BOOTP will cause this process to fail.

Erasing the Core Software via Debug

1. Run Manager.

- In the BOOTP entries, check that there is an entry that matches the MAC Address, IP Address and .bin file used by the system. An entry is normally automatically created when a configuration has been loaded from that IP Office.
 - If an entry is not present, create a new entry manually. The first two details can be found in the Control Unit settings in the configuration file. Then close and restart Manager.
- Under File | Preferences ensure that Manager is set to 255.255.255.255. Also check that Enable BootP Server is checked.
- Select View | TFTPLog.
- Check that the required .bin file is present in Manager's working directory.

2. Attach the serial cable between the PC and the DTE port on the IP Office control unit.

- a. Start the terminal program on your PC. Ensure that it has been setup as listed in [DTE Port Settings](#)^[107]. Within a HyperTerminal session, the current settings are summarized across the base of the screen.
- b. Enter AT (note upper case). The control unit should respond *OK*.
- c. Enter AT-DEBUG. The control unit should response with the time and date and then *Hello>* to show it is ready to accept commands.

3. To erase the current configuration in RAM memory enter upgrade.

4. The IP Office will erase its current software and then send out a BootP request on the network for new software. Manager will respond and start transferring the software using TFTP.

Erasing the Core Software via the Boot Loader

2. Run Manager.

- In the BOOTP entries, check that there is an entry that matches the MAC Address, IP Address and .bin file used by the system. An entry is normally automatically created when a configuration has been loaded from that IP Office. .
 - If an entry is not present, create a new entry manually. The first two details can be found in the Control Unit settings in the configuration file. Then close and restart Manager.
- Under File | Preferences ensure that Manager is set to 255.255.255.255. Also check that Enable BootP Server is checked.
- Select View | TFTPLog.
- Check that the required .bin file is present in Manager's working directory.

2. Attach the serial cable between the PC and the DTE port on the IP Office control unit.

- a. Start the terminal program on your PC. Ensure that it has been setup as listed in [DTE Port Settings](#)^[107]. Within a HyperTerminal session, the current settings are summarized across the base of the screen.
- b. Arrange the program windows so that the Terminal program and Manager TFTP Log are visible at the same time.
- c. Switch off power to the IP Office control unit.
- d. Power on the control unit and press the escape key every second until you get a Loader message. Below is an example.

```
P12 Loader 2.4  
CPU Revision 0x0900
```

- e. Enter AT (note upper case). The control unit should respond *OK*.
- f. If an OK response is not received, check the settings of your terminal program and repeat the process above.

3. Enter AT-X. The control unit should respond Multi-Sector Erase.

4. The control unit will now request the .bin file it requires. For IP500v2 control units this will be from files on the System SD card. For other control units it will be from Manager and appears in the TFTP Log.

5. If the file transfers does not appear to be taking place, check that the IP address shown in the TFTP Log matches the BOOTP entry. Adjust the BOOTP entry if necessary.

6. When completed the system will reboot.

Chapter 7.

SD Card Management

7. SD Card Management

The IP500v2 control unit has two SD card slots, labeled System SD and Optional SD respectively. These are used as follows:

- System SD Card

An Avaya System SD card must be present in this slot at all times. This card holds copies of the IP Office firmware and configuration and is used as the IP500v2 control units non-volatile memory.

- Each Avaya System SD card has a unique Feature Key serial number which is used for generating and validating licenses entered into the IP Office configuration.
- The card stores the prompts for embedded voicemail operation and acts as the message store for embedded voicemail messages.
- Prior to any planned shutdown or restart of the IP Office system, the current configuration running in the IP Office system's RAM memory is copied to the /primary folder on the System SD card and to the systems non-volatile memory.
- Following a restart, the software in the /primary folder is loaded by the IP500v2 control unit. If the required software is not present or valid a sequence of fallback options is used, see [Booting from the SD Cards](#)^[117] for full details.
- Following a restart, if present, the configuration file in the /primary folder is loaded by the IP500v2 control unit. If no file is present the system will check for a file in its internal non-volatile memory. If no copy is found it will generate a default configuration file. See [Booting from the SD Cards](#)^[117] for full details.
- Once each day (approximately between 00:00 and 00:30) the IP Office will copy the current configuration running in its RAM memory to the /primary folder on the card.
- Configuration changes made using IP Office Manager are first written to the copy of the configuration file on the card and then merged with the configuration running in the IP Office system's RAM memory.
- The write lock setting on cards in the System SD card slot is ignored.

- Optional SD Card

A card does not have to be present in this slot for normal IP Office operation. The slot can be used for various maintenance actions.

- A card with an updated IP Office software or configuration can be inserted and those files then transferred to the System SD card in order to upgrade the IP Office system.
- The full contents of the System SD card can be copied to the Optional SD card while the IP Office system is running.
- The write lock setting on cards in the Optional SD card slot is honored.



Card Removal

Memory cards should always be [shutdown](#)^[129] before being removed when the system is running. Though the card slot LEDs indicate when data is being written to an card, lack of flashing LED is not a sufficient safeguard. Shutting down the card will disable embedded voicemail if being used. If the System SD card is removed, features licensed by the card's Feature Key serial number will continue operating for up to 2 hours.

Card Maintenance Actions

Using IP Office Manager, IP Office System Status Application or [Phone Based Administration](#) ^[52], a number of actions can be performed on the SD cards.

Action	Description	Manager	System Status	System Phone	Minutes
Shutdown/Restart ^[129]	Memory cards should always be shutdown ^[129] before being removed when the system is running. Though the card slot LEDs indicate when data is being written to an card, lack of flashing LED is not a sufficient safeguard. Shutting down the card will disable embedded voicemail if being used. If the System SD card is removed, features licensed by the card's Feature Key serial number will continue operating for up to 2 hours.	✓	✓	✓	–
Backup ^[121]	Copy the files in the /primary folder on the System SD card to the /backup folder on the card.	✓	✓	✓	6
Restore ^[122]	Copy the files in the /backup folder on the System SD card to the /primary folder on the card and restart the IP Office system.	✓	✓	✓	6
Copy ^[123]	Copy all the files on the System SD card to the Optional SD card.	✓	✓	✓	90
Upgrade Binaries ^[126]	Copy software files in the /primary folder on the Optional SD card to the /primary folder on the System SD card and then restart the IP Office system.	✓	–	✓	5
Upgrade Configuration ^[126]	Copy the configuration file in the /primary folder on the Optional SD card to the /primary folder on the System SD card and then restart the IP Office system.	✓	–	–	5 seconds
Upload System Files ^[126]	Upload a set of IP Office software and embedded voicemail prompts to the System SD card.	✓	–	–	40
View Files ^[126]	View the folders and files on the control unit memory cards.	✓	–	–	–
	The actions below can be performed on cards in a SD card reader on a PC running IP Office Manager.				
Format ^[119]	Reformat a card for IP Office usage without removing the Feature Key serial number. <ul style="list-style-type: none"> ⚠ This process will erase all existing files on the card. 	✓	✓	–	1
Recreate ^[119]	Create the folder structure on a memory card and copy a set of IP Office software files into those folders.	✓	–	–	15

- Process marked as System Phone can be performed through [phone based administration](#) ^[52] from either of the first two systems in the system. For details, refer to the IP Office Essential Edition - Quick Version Phone Based Administration manual.

Card Specification

Non-Avaya cards can be used in the Optional SD slot as long as they match or exceed the standard below:

- SDHC 4GB minimum Class 2+. Single partition FAT32 format.

SD Card Folders

The System SD card contains the following folders:

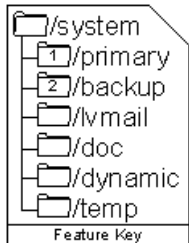

- /primary
Contains the firmware files for the IP Office control unit, external expansion modules and supported phones. The folder can also contain music on hold files and license key files. This is the main set of files used by the IP Office system when booting up. Also contains the stored copy of the IP Office configuration.
- /backup
Contains a copy of the primary folder at some previous point. A backup copy of the primary contents to this folder can be invoked manually (using Manager or SSA) or as part of the IP Office software upgrade using Manager.
- /lvmail
Contains the system prompts used by embedded voicemail. Note that the mailbox messages and greetings are stored in a sub-folder of the /dynamic folder.
 - The sub-folder /AAG is used to store embedded voicemail auto-attendant greetings.
- /doc
Contains initial installation documentation for IP Office and Avaya IP Office Essential Edition Partner Version.
- /dynamic
Contains files used by the IP Office and retained through a reboot of the IP Office system.
 - The sub-folder /lvmail is used to store individual user and group mailbox messages, name recordings and announcements. The storage capacity for embedded voicemail is limited to 15 hours regardless of the capacity of the card.
- /temp
Contains temporary files used by the IP Office and not retained through a reboot of the IP Office system.

The Optional SD card can contain a similar set of folders. These are used as an additional backup or they can be used as the source for upgrading the contents of the System SD card.

7.1 Booting from the SD Cards

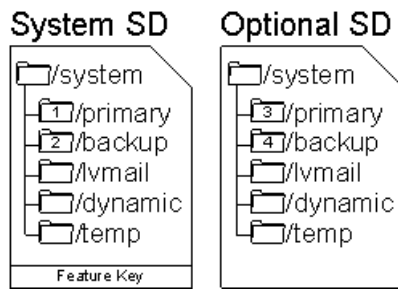

When being powered up, the IP500v2 control unit looks for a valid ip500v2.bin binary file to load. It does this using the possible source below in the order shown, skipping to the next source if the file is not present or is not valid.

1. System SD card */primary* folder.
2. The control unit's own internal non-volatile memory. Once a system has been installed, it uses its non-volatile memory to keep copies of the configuration and system binary files it is using. These can be used to restore operation during a system reboot. Note that though a system can boot from non-volatile memory, a System SD card must still be present for correct system operation.
3. System SD card */backup* folder.
4. Optional SD card */primary* folder.
5. Optional SD card */backup* folder.
6. If no file is found, the control unit will fallback to making BOOTP requests to the network. IP Office Manager can respond the BOOTP request. See [Erasing the Operational Firmware](#) ^[117].

Once a valid ip500v2.bin file is found, the IP Office control unit will load that firmware. The source from which the control unit binary file was loaded is then used to load further files.

Configuration File Loading

Having installed the necessary system firmware files as above, the IP500v2 control unit requires a configuration file:

- If the IP500v2 booted using binary files from an SD card location, it looks for a valid configuration file in the same location.
 - If a configuration file is present and valid, it is loaded.
 - If a configuration file is present but is not valid, load the configuration copy in its non-volatile memory if present, else it assumes a default configuration.
 - If a configuration file is not present, use the non-volatile memory copy as above unless the reboot is as a result of a default system command.
- If the IP500v2 booted using binary files from its non-volatile memory, it will also load the configuration copy from that location.
 - It will indicate a boot alarm (see below).
 - It will attempt to restore the firmware file in the System SD card's */primary* folder using the copy in its non-volatile memory.
 - The normal boot up process of upgrading expansion module firmware does not occur. If the File | Advanced | Upgrade command is used, only external expansion modules actually present in the system are listed for upgrade.

Post Boot Operation

During normal operation, configuration and binary files sent to the System SD card */primary* folder using IP Office Manager are also written to the non-volatile memory.

If the system has booted from its non-volatile memory due to an SD card problem, it is still possible to upgrade the ip500v2.bin file using the IP Office upgrade wizard.

Boot Alarms

The following apply if the IP500v2 boots using software other than that in its System SD /primary folder:

- An alarm will be shown in the System Status Application. It will also generate an alarm if the card in any slot is not compatible. These alarms are also output as SNMP, Syslog or email alarms.
- The IP Office Manager Select IP Office menu will display an  icon indicating that the IP Office system is running using software other than from the System SD card's primary folder.
- The configuration can be read but will be read only. Attempting to send a configuration to the system will cause the error message *Failed to save configuration data. (Internal error)*.

Bypassing the System SD Card Primary Folder

The control unit can be forced to bypass the System SD card's /primary folder and non-volatile memory when starting. This is done by pressing the Aux button while applying power to the control unit.

This action may be necessary if, following an upgrade of the IP Office system, it is determined that a roll back to the previously backed up firmware and configuration is required. Using the Aux button should restore system operation using the /backup folder files while the installer then restores the contents of the /primary folder to a previous release.

7.2 Creating an IP Office SD Card

The processes below can be applied to Avaya IP Office SD cards. They can also be applied to non-Avaya SD cards for use in a system's Optional SD card slot.

The card must be the following format. For the System SD slot, only Avaya SD cards with a Feature Key should be used.

- SDHC 4GB minimum Class 2+. Single partition FAT32 format.
-  **WARNING**
Avaya supplied SD cards should not be formatted using any other method than the format commands within IP Office Manager and IP Office System Status Application. Formatting the cards using any other method will remove the feature key used for IP Office licensing from the card.

Creating a Card on a Local PC

These processes can be run on an SD card inserted in a card reader on the IP Office Manager PC. That card can then be used in the System SD card slot of a new system or in the Optional SD card slot of an existing system to [upgrade that system](#)^[100].

Formatting an SD Card

Avaya SD cards should only be formatted using the format options provided within IP Office applications. This process is not normally necessary with Avaya SD cards unless you suspect that the card has been incorrectly formatted elsewhere.

-  **WARNING: All File Will Be Erased**
Note that this action will erase any existing files and folders on the card. Once a card has been formatted, the folders and files required for IP Office operation can be loaded onto the card from the Manager PC using the Recreate IP Office SD Card command.
1. Insert the SD card into a reader slot on the Manager computer.
 2. Using IP Office Manager, select File | Advanced | Format IP Office SD Card.
 3. Select IP Office A-Law, IP Office U-Law or IP Office Partner Version. This selection just sets the card label shown when viewing the card details. It does not affect the actual formatting. Select the label that matches the files set you will be placing on the card.
 4. Browse to the card location and click OK.
 5. The status bar at the bottom of Manager will display the progress of the formatting process.
 6. When the formatting is complete, you can use the Recreate IP Office SD Card command to load the IP Office folders and files onto the card from the Manager PC.

Recreating an IP Office SD Card

This command can be used with a read-writeable SD card on the Manager PC. It copies the files and folders used by an IP500v2 system when starting. It updates the card with the version of those files installed with the IP Office Manager application. It includes the binary files for the IP500v2 system, external expansion modules and phones. It also includes the prompt files for embedded voicemail operation.

This process just replaces existing files and adds new files. It does not delete files, so for example, any existing embedded voicemail messages and greetings are retained. If the card contains dynamic system files such as SMDR records, they are temporarily backed up by Manager and then restored after the card is recreated.

For the card to be used in an IP500v2 system's System SD slot the card must be Avaya SD Feature Key card. The card must be correctly formatted, however a reformat of an existing working card is not necessary before using recreate to update the card contents.

- The source for the files copied to the SD card are the sub-folders of the *VMemory Cards* folder under Manager's Working Directory (normally *C:\Program Files Avaya\IP Office\Manager*). However, if the Working Directory is changed to a location without an appropriate set of *VMemory Cards* sub-folders, the required set of files will not be copied onto the SD card.
1. Once started do not interrupt this process, for example by removing the SD card. This process takes approximately 15 minutes.
 2. Insert the SD card into a card reader on the Manager PC.
 3. Using IP Office Manager, select File | Advanced | Recreate IP Office SD Card.
 4. Select IP Office A-Law, IP Office U-Law or IP Office Partner Version. This selection will affect how the IP Office systems operates when defaulted with this card present in its System SD card slot. .

5. Browse to the card location and click OK.
6. Manager will start creating folders on the SD card and copying the required files into those folders. This process will take approximately 15 minutes.
7. Do not remove the SD card during the process. Wait until the Manager displays a message.



7.3 Viewing the Card Contents

Using IP Office Manager you can view the folders and files on the System SD card and the Optional SD card. You can then use various commands to upload and download files to and from the cards.

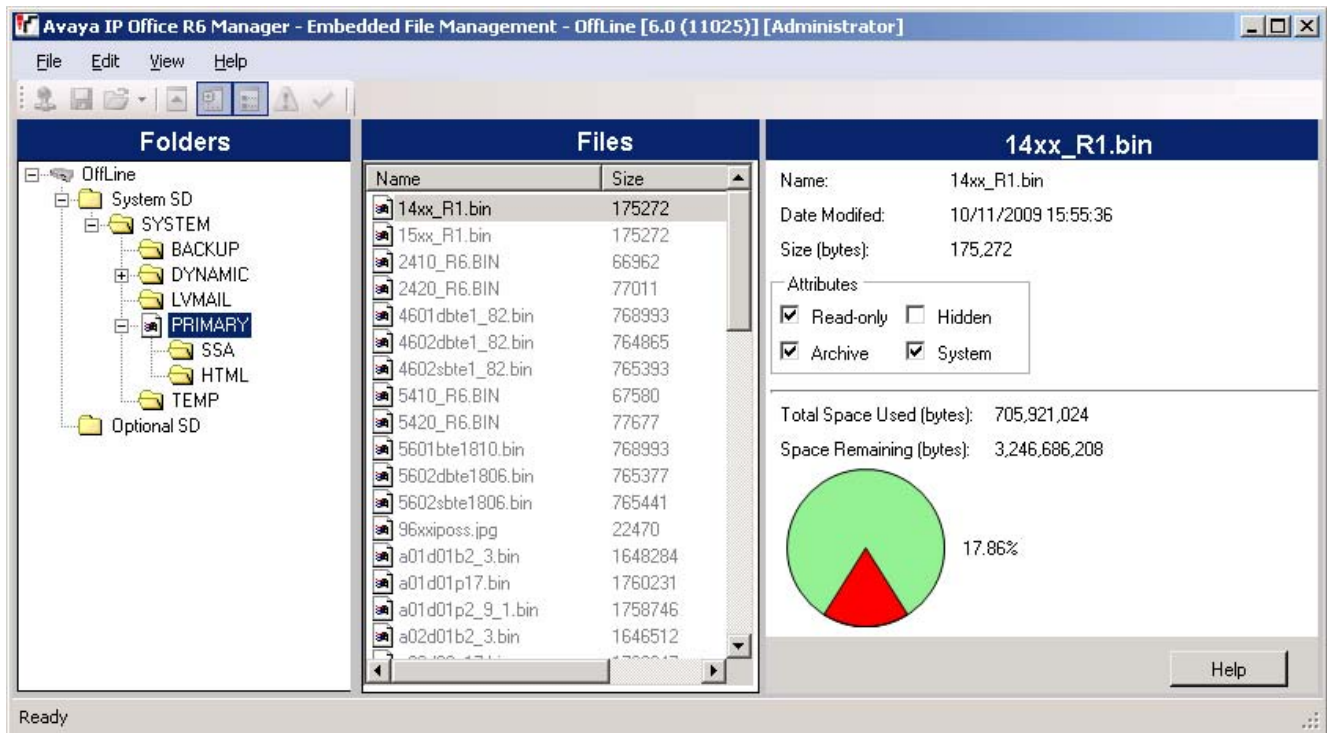

1. Using IP Office Manager, select File | Embedded File Management.
2. Using the Select IP Office menu, select the IP Office system.
3. The file contents of the memory cards are displayed.

7.4 Backing Up the System SD Card

There are two levels of backup that can be performed.

- [Backup the System SD Card Primary Folder](#) ^[121]
The contents of the primary folder on the card can be copied to the backup folder. The files can then be restored if necessary. Both actions can be performed remotely.
- [Backup the Whole System SD Card](#) ^[123]
The contents of the whole System SD card can be copied to the Optional SD card. While this can be done remotely, the contents can only be copied back manually using a card reader.

The backup, restore and copy operations will not be performed if the destination card has insufficient space for the files being copied.

7.4.1 Backing Up the Primary Folder

This process copies the contents of the /primary folder on the System SD card over the /backup folder. Any files with matching file names will be replaced.

This takes approximately 6 minutes.

Using IP Office Manager

1. Using IP Office Manager, select File | Embedded File Management.
2. Using the Select IP Office menu, select the IP Office system.
3. The file contents of the memory cards are displayed.
4. Select File | Backup System Files.
 - The contents of the /primary folder on the System SD card will be copied to the /backup folder. This process takes approximately 6 minutes.

Using the System Status Application

1. Start [System Status](#) ^[51] and access the IP Office's status output.
2. In the navigation panel select System.
3. At the bottom of the screen select Backup System Files.
 - The contents of the /primary folder on the System SD card will be copied to the /backup folder. This process takes approximately 6 minutes.

7.4.2 Restore from the Backup Folder

The contents of the /backup folder on the System SD card can be copied to the /primary folder. Any files with matching file names will be replaced. The IP Office is then restarted using the files now in the /primary folder.

- **! WARNING**

This process will require the IP Office system to reboot in order to complete the process. Any current calls and services will be ended by the reboot.

Using IP Office Manager

1. Using IP Office Manager, select File | Embedded File Management.
2. Using the Select IP Office menu, select the IP Office system.
3. The file contents of the memory cards are displayed.
4. Select File | Restore System Files.
 - The contents of the /backup folder on the System SD card will be copied to the /primary folder. The process takes approximately 6 minutes.
 - When the process has been completed, the IP Office system will be restarted.

Using the System Status Application

1. Start [System Status](#)  and access the IP Office's status output.
2. In the navigation panel select System.
3. At the bottom of the screen select Restore System Files.
 - The contents of the /backup folder on the System SD card will be copied to the /primary folder. The process takes approximately 6 minutes.
 - When the process has been completed, the IP Office system will be restarted.

7.4.3 Backing Up to the Optional Card

This process copies all files on the System SD card to the Optional SD card. It includes the /primary and /backup folders and the embedded voicemail files including message files. Any matching files and folders on the Optional SD card are overwritten.

The process is a simple copy. Any files already copied that change while the process are not recopied. Any new files added (for example voicemail messages) while the process is running may not be copied.

This process takes at least 90 minutes and may take much longer depending on the amount of data to be copied, for example it will be longer if embedded voicemail is being used by the IP Office system to take messages.

Using IP Office Manager

1. Using IP Office Manager, select File | Embedded File Management.
2. Using the Select IP Office menu, select the IP Office system.
3. The file contents of the memory cards are displayed.
4. Select File | Copy System Card.
 - The contents of the System SD card will be copied to the Optional SD card. This process at least 90 minutes and can take much longer.

Using the System Status Application

1. Start [System Status](#)  and access the IP Office's status output.
2. In the navigation panel select System.
3. Select Memory Cards.
4. Select System Card.
5. At the bottom of the screen select Copy System Card.
 - The contents of the System SD card will be copied to the Optional SD card. This process at least 90 minutes and can take much longer.

7.4.4 Restoring from the Optional Card

The files in the `/primary` folder on the Optional SD card can be copied to the `/primary` folder on the System SD card. Any files with matching file names will be replaced. The IP Office is then restarted using the files now in the System SD card's `/primary` folder.

The restore process is separated into two parts, either copying configuration files from the Optional SD card or copying software files from the Optional SD card. This allows software files to be copied from an Optional SD card without affecting the existing configuration of that system.

- **! WARNING**

This process will require the IP Office system to reboot in order to complete the process. Any current calls and services will be ended by the reboot.

7.4.4.1 Restoring a Configuration from an Optional Card

The following processes copy the configuration file (*config.cfg*) and licenses file (*keys.txt*). The processes take a few seconds.

- **! WARNING**



This process will require the IP Office system to reboot in order to complete the process. Any current calls and services will be ended by the reboot.

Copying a Configuration from the Optional SD Card File Using IP Office Manager

1. Using IP Office Manager, select File | Embedded File Management.
2. Using the Select IP Office menu, select the IP Office system.
3. The file contents of the memory cards are displayed.
4. Select File | Upgrade Configuration.
 - The configuration file (*config.cfg*) and licenses file (*keys.txt*) in the `/primary` folder on the Optional SD card are copied to the `/primary` folder on the System SD card. This process takes approximately a few seconds.
 - When the process has been completed, the IP Office system will be restarted.

7.4.4.2 Restoring Software from an Optional SD Card

These processes copy all files in the folder except the configuration file (*config.cfg*) and licenses file (*keys.txt*). The processes take approximately 5 minutes. These processes do not restore embedded voicemail prompts (see [Upgrading Card Software](#) [128]).



-  IP Office Technical Bulletins
Ensure that you have obtained and read the IP Office Technical Bulletin relating to the IP Office software release which you are installing. This bulletin will contain important information that may not have been included in this manual. IP Office Technical Bulletins are available from the [Avaya support](http://support.avaya.com) website (<http://support.avaya.com>).
-  Upgrade Licenses
Some upgrades may require entry of upgrade licenses.
- **! WARNING**
This process will require the IP Office system to reboot in order to complete the process. Any current calls and services will be ended by the reboot.

Copying Software Files from the Optional SD Card Using IP Office Manager

1. Using IP Office Manager, select File | Embedded File Management.
2. Using the Select IP Office menu, select the IP Office system.
3. The file contents of the memory cards are displayed.
4. Select File | Upgrade Binaries.
 - The software files (all files in the folder except the configuration file (*config.cfg*) and licenses file (*keys.txt*)) in the */primary* folder on the Optional SD card are copied to the */primary* folder on the System SD card. This process takes approximately 5 minutes.
 - When the process has been completed, the IP Office system will be restarted.

7.5 Upgrading Card Software

In addition to using the traditional [IP Office Upgrade Wizard](#)^[98], IP500v2 control units can be upgraded by loading the required set of firmware files onto the System SD card and rebooting the system.

-  IP Office Technical Bulletins
 Ensure that you have obtained and read the IP Office Technical Bulletin relating to the IP Office software release which you are installing. This bulletin will contain important information that may not have been included in this manual. IP Office Technical Bulletins are available from the [Avaya support](http://support.avaya.com) website (<http://support.avaya.com>).
-  Upgrade Licenses
 Some upgrades may require entry of upgrade licenses.
- ! WARNING**
 This process will require the IP Office system to reboot in order to complete the process. Any current calls and services will be ended by the reboot.

There are a number of ways in which this can be done.

Method	Description	Location	Software Files	Embedded Voicemail Prompts
Using Manager ^[127]	Using IP Office Manager, the contents of the card are compared to the files that Manager has available and are upgraded if necessary.	Local or Remote	✓	✓
System SD Card Upgrade ^[127]	In this method, the System SD card is shut down and removed from the control unit. The card's contents are upgraded using IP Office Manager.	Local	✓	✓
Upgrade from Optional SD Card ^[128]	This method uses an SD card loaded with the required version of IP Office software. The card is inserted into the control unit's Option SD card slot and its contents copied to the System SD card.	Local	✓	–

7.5.1 Upgrading Remotely Using Manager

This process will copy all system files not present or of a different version compared to those already present on the System SD card. That includes IP Office software files and embedded voicemail prompt files.

1. Using IP Office Manager, select File | Embedded File Management.
2. Using the Select IP Office menu, select the IP Office system.
3. The file contents of the memory cards are displayed.
4. Select File | Backup System Files. The contents of the /primary folder on the System SD card will be copied to the /backup folder. This process takes approximately 6 minutes.
5. Select File | Upload System Files. The system files that Manager has will be uploaded to the /primary folder on the System SD card. This includes IP Office software files and embedded voicemail prompt files. Depending on the files that need to be updated, this process can take up to 40 minutes.

7.5.2 Upgrading the SD Card Locally

The following process can be used if you have physical access to the IP500v2 control unit. This method be used with a timed reboot, allowing the card upgrade to be done during normal operation hours followed by a reboot outside of normal operation hours.

If the card is being used for embedded voicemail, that service is not available while the card is shutdown. Licensed features however will continue running for up to 2 hours while the card is shutdown.

1. [Shutdown the System SD memory card](#)^[129] and remove it from the control unit.
2. Follow the process for [recreating the SD card](#)^[119]. This process will overwrite the software files on the card with the files available to IP Office Manager. It will not affect any other files, for example the configuration file and embedded voicemail messages. This process takes approximately 15 minutes.
3. When the recreate process has completed, reinsert the card into the control unit's System SD card slot.
4. Using IP Office Manager select File | Advanced | Reboot.
5. In the Select IP Office menu, select the IP500v2 system and click OK.
6. Select the type of reboot that you want performed and click OK.
7. When the system is rebooted, as it restarts it will load the software files in the primary folder of the System SD card.

7.5.3 Upgrading Using an Optional SD Card

This method allows an Optional SD card to be used as the source from which the System SD card is upgraded. It only upgrades the software files, it does not update embedded voicemail prompts.

1. Once started do not interrupt this process, for example by removing the SD card. This process takes approximately 15 minutes.
2. Insert the SD card into a card reader on the Manager PC.
3. Using IP Office Manager, select File | Advanced | Recreate IP Office SD Card.
4. Select IP Office A-Law, IP Office U-Law or IP Office Partner Version. This selection will affect how the IP Office systems operates when defaulted with this card present in its System SD card slot. .
5. Browse to the card location and click OK.
6. Manager will start creating folders on the SD card and copying the required files into those folders. This process will take approximately 15 minutes.
7. Do not remove the SD card during the process. Wait until the Manager displays a message.



7. Insert the card into the control unit's Optional SD card slot.
8. Use one of the processes below to copy the software from the Optional SD card to the System SD card. Each of those processes will cause the IP Office system to be restarted.

Copying Software Files from the Optional SD Card Using IP Office Manager

1. Using IP Office Manager, select File | Embedded File Management.
2. Using the Select IP Office menu, select the IP Office system.
3. The file contents of the memory cards are displayed.
4. Select File | Upgrade Binaries.
 - The software files (all files in the folder except the configuration file (*config.cfg*) and licenses file (*keys.txt*) in the */primary* folder on the Optional SD card are copied to the */primary* folder on the System SD card. This process takes approximately 5 minutes.
 - When the process has been completed, the IP Office system will be restarted.

7.6 Removing SD Cards



Card Removal

Memory cards should always be [shutdown](#) before being removed when the system is running. Though the card slot LEDs indicate when data is being written to an card, lack of flashing LED is not a sufficient safeguard. Shutting down the card will disable embedded voicemail if being used. If the System SD card is removed, features licensed by the card's Feature Key serial number will continue operating for up to 2 hours.

The following processes can be used with SD cards installed in IP500v2 control units and also with Compact Flash memory cards installed in IP406 V2 control units.

7.6.1 Card Shutdown



Card Removal

Memory cards should always be [shutdown](#) before being removed when the system is running. Though the card slot LEDs indicate when data is being written to an card, lack of flashing LED is not a sufficient safeguard. Shutting down the card will disable embedded voicemail if being used. If the System SD card is removed, features licensed by the card's Feature Key serial number will continue operating for up to 2 hours.

Before a memory card is removed from an IP Office system that is running, the card must be shutdown. Removing a memory card while the system is running may cause file corruption.

Card services can be restarted by either reinserting the card or using a Start Up command.

Card Shutdown Using IP Office Manager

1. Using IP Office Manager, select File | Advanced | Memory Card Commands | Shutdown.
2. Using the Select IP Office menu, select the IP Office system containing the memory card.
3. Click OK.
 - At the back of the control unit, confirm that the appropriate memory card LED is off.
 - The card can now be removed in order to perform the necessary maintenance actions.

Card Shutdown Using the System Status Application

1. Start [System Status](#) and access the IP Office's status output.
2. In the navigation panel select System.
3. Select Memory Cards.
4. Select either System Card or Optional Card.
5. At the bottom of the screen select Shutdown.
 - At the back of the control unit, confirm that the appropriate memory card LED is off.
 - The card can now be removed in order to perform the necessary maintenance actions.

7.6.2 Card Startup

Reinserting a memory card into a system that is already switched on will automatically restart card operation. However, if the card has been shutdown but not removed, it can be restarted using Manager without requiring a reboot.

Card Startup Using IP Office Manager

1. Using IP Office Manager, select File | Advanced | Memory Card Commands | Startup.
2. Using the Select IP Office menu, select the IP Office system containing the memory card.
3. Click OK.

Card Startup Using the System Status Application

1. Start [System Status](#)  and access the IP Office's status output.
2. In the navigation panel select System.
3. Select Memory Cards.
4. Select either System Card or Optional Card.
5. At the bottom of the screen select Start Up.

7.6.3 System Shutdown

IP Office systems running IP Office Release 6 can be shut down in order to perform maintenance. The shut down can be either indefinite or for a set period of time after which the IP Office will automatically reboot.

During the shut down process, the current configuration in the control unit's RAM memory is copied to the control units non-volatile memory. For IP500v2 systems that location is the System SD card.

For control units with memory cards the memory cards can be [shutdown and restarted](#) ^[129] separately from the system.

! WARNINGS

- A shutdown must always be used to switch off the system. Simply removing the power cord or switching off the power input may cause errors.
- This is not a polite shutdown, any users calls and services in operation will be stopped. Once shutdown, the system cannot be used to make or receive any calls until restarted.
- The shutdown process takes up to a minute to complete. When shutdown, the CPU LED and the IP500 base card LEDs 1 and 9 (if trunk daughter card fitted) will flash red rapidly. The memory card LEDs are extinguished. Do not remove power from the system or remove any of the memory cards until the system is in this state.
- To restart a system when shutdown indefinitely, or to restart a system before the timed restart, switch power to the system off and on again.

System Shutdown Using IP Office Manager

1. Using IP Office Manager, select File | Advanced | System Shutdown.
2. Using the Select IP Office menu, the System Shutdown Mode menu is displayed.

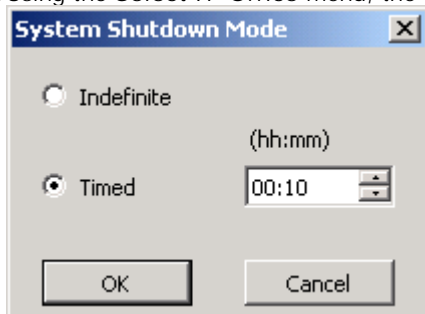

3. Select the type of shutdown required. If Indefinite is used, the system can only be restarted by having its power switched off and then on again. If a Timed shutdown is selected, the IP Office will reboot after the set time has elapsed.

System Shutdown Using the System Status Application

1. Start [System Status](#) ^[57] and access the IP Office's status output.
2. In the navigation panel select System.
3. At the bottom of the screen select Shutdown System.
4. Select the time duration for the shutdown or indefinite.

System Shutdown Using the IP500v2 AUX Button

When the AUX button is pressed for more than 5 seconds, the IP500v2 control unit will shutdown with the restart timer set to 10 minutes.

Chapter 8.

System Components

8. System Components

This section covers the individual components that can comprise an IP Office installation.

- [Control Units](#) ^[135]
- [IP500 Base Cards](#) ^[137]
- [IP500 Trunk Daughter Cards](#) ^[145]
- [IP500 External Expansion Modules](#) ^[149]
- [Feature Keys/SD Cards](#) ^[159]
- [Mounting Kits](#) ^[161]
- [Phones](#) ^[163]
- [Phone Add-Ons](#) ^[183]
- [Ancillary Systems](#) ^[187]
- [Physical Ports](#) ^[195]
- [Licenses](#) ^[210]

8.1 IP500v2 Control Unit

The slots are numbered 1 to 4 from left to right. They can be used in any order. However if the capacity for a particular type of card is exceeded, the card in the rightmost slot will be disabled. The unit must not be used with uncovered slots.

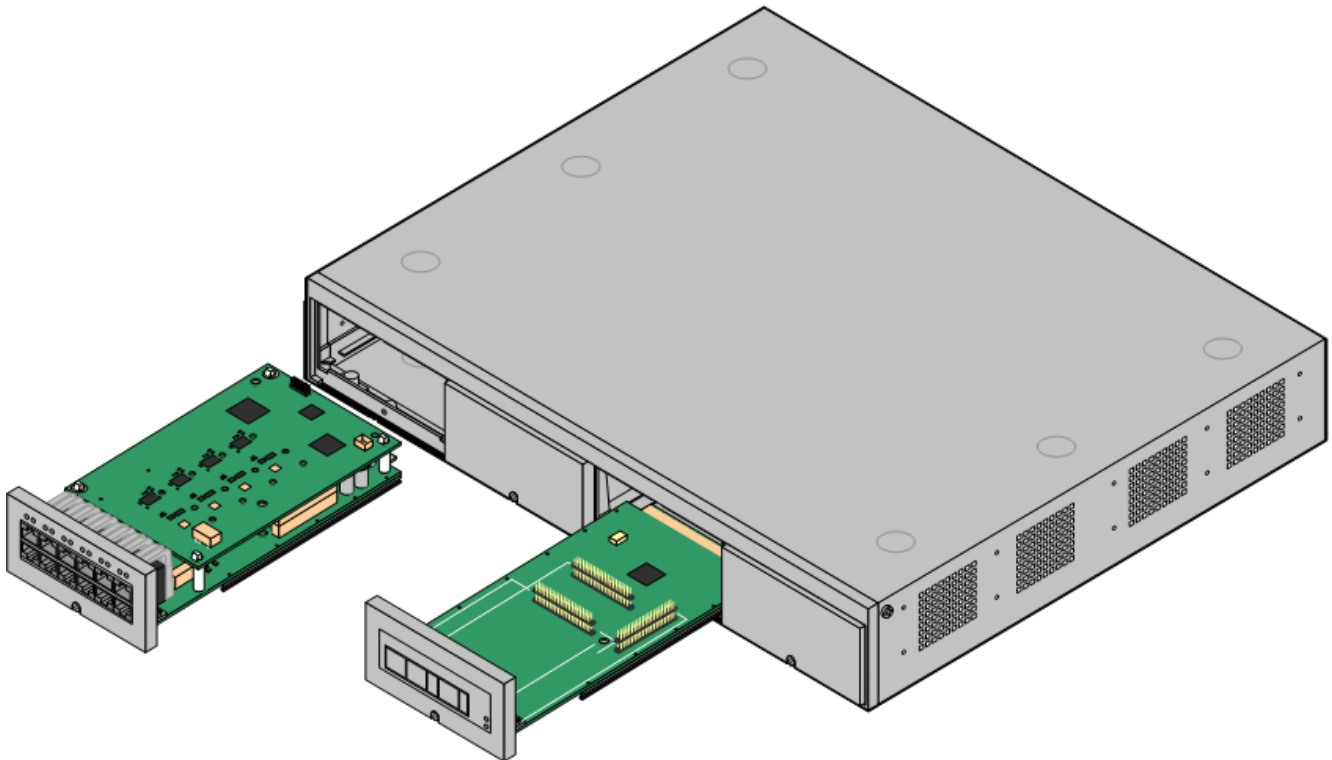

Feature	Capacity
Maximum Extensions	Up to 100 extensions in mode.
Conference Parties	128 as standard but maximum 64 in any individual conference. Silence suppression is applied to conferences with more than 10 parties.
Trunks Cards	4. Any combination of IP500 trunk daughter cards and up to 2 IP400 trunk cards.
Voice Compression Channels	Up to 20 using IP500 Combination cards.
Voicemail Channels	For Embedded Voicemail, up to 6 (2 by default, additional channels require licenses).
Locales	Supported in all IP Office locales.
Software Level	IP Office Essential Edition - Quick Version Mode: 7.0 minimum. Bin file = ip500v2.bin.
Power Supply	Internal power supply unit.
Mounting	Free-standing, rack mounted (requires IP500 Rack Mounting Kit) or wall mounted (requires IP500 Wall Mounting Kit).
Dimensions	Width: 445mm/17.5". Depth: 365mm/14.4". Height: 73mm/2.9"/2U. Clearance: 90mm minimum all sides, 220mm at front.
Memory	Maximum configuration file size: 2048KB.

Name	Description	Country	SAP Code
IPO 500 V2 Base Unit	IP Office 500 V2 Base Unit		700476005
Avaya SD Memory Card	IPO System SD Card A-Law		700479702
	IPO System SD Card Mu-Law		700479710
	IPO System SD Card Partner		700479728
IEC60320 C13 Earthed Power Cord	CEE7/7	Europe	700289762
	BS1363	United Kingdom	700289747
	NEMA5-15P	America	700289770
IP500 Rack Mounting Kit	IP500 Rack Mounting Kit		700429202
IP500 Wall Mounting Kit V2	IP500 Wall Mounting Kit		700500923
IP500 Wall Mounting Kit	IP500 Wall Mounting Kit		700430150
IP500 Blanking Plate Kit	IP500 Blanking Plate Kit		700429194

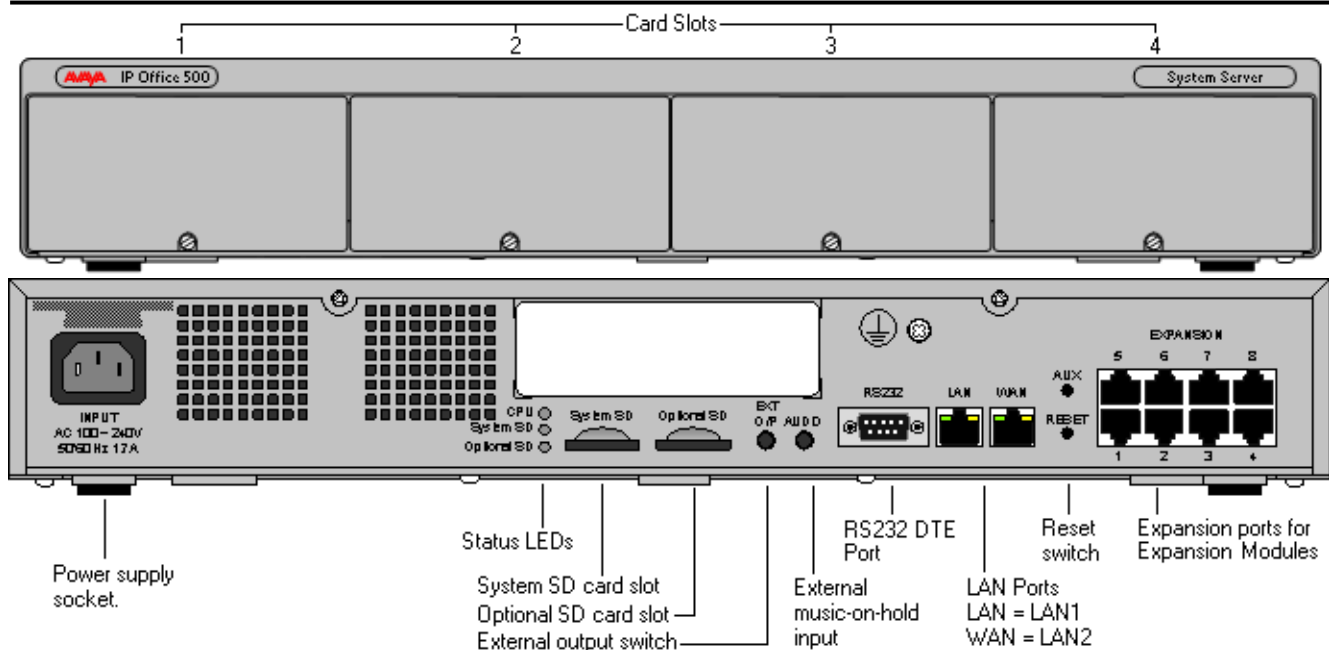

Ports	Description
AUDIO ^[19]	3.5mm Stereo jack socket. Used for external music on hold source input.
AUX ^[11]	If pressed during a restart of the control unit, the control unit skip booting ^[11] from the <code>/primary</code> folder on the System SD card. If pressed for more than 5 seconds when a system is running, the control unit will shutdown ^[9] for 10 minutes.
CPU	Indicates the status of the control unit. <ul style="list-style-type: none"> • Alternate red/green = Starting up. • Green on = Okay. • Red on = No software. • Flashing Red = Error/Shutdown.
EXPANSION ^[20]	RJ45 socket. Used for direct connection to external expansion modules using the Expansion Interconnect cable supplied with the expansion module.
EXT O/P ^[10]	3.5mm Stereo jack socket. Used for switching external relay systems such as door entry controls. The port contains two independent switches controlled by the IP Office.
INPUT ^[21]	AC power input port.
LAN ^[20]	RJ45 socket. The port is a full-duplex 10/100Mbps auto-sensing, MDI crossover port.
Optional SD ^[11]	Used for the Optional SD card. The LED is used in the same way as for the System SD (<i>see below</i>).
RESET ^[10]	This switch is used to restart the IP Office, optionally erasing the configuration and or the core software in the process. See Reset Button ^[10] .
RS232 ^[10]	9-Way D-Type socket. Used for system maintenance.
System SD ^[11]	Used for the System SD card,. The LED is used as follows. <ul style="list-style-type: none"> • Off = Card shutdown ^[12]. • Green on = Card present. • Green flashing = Card in use. • Orange steady = Reset imminent. • Red flashing = Card initializing or shutting down. • Red fast flashing = card full • Red steady = Card failure/wrong type.
WAN ^[20]	RJ45 socket. This port is not supported on systems running in IP Office Essential Edition - Quick Version mode.
	Used for connection of a functional or protective ground ^[73] . Use of a ground for all systems is recommended and for some locales may be a regulatory requirement.

8.2 IP500 Base Cards

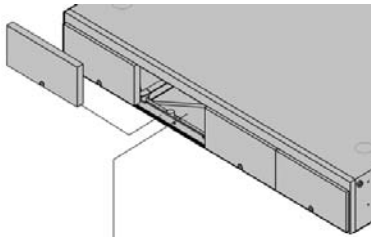

The IP500 and IP500v2 control units have 4 slots for the insertion of IP500 base cards. The slots are numbered 1 to 4 from left to right. Normally they can be used in any order, however if the capacity for a particular type of card is exceeded, the card in the rightmost slot will be disabled.

Each base card includes an integral front panel with ports for cable connections. Typically the first 8 ports on the left are for connection of extension devices. The 4 ports on the left are used for connection of trunks if a [trunk daughter card](#) is added to the base card.

[IP500 Digital Station Base Card](#)

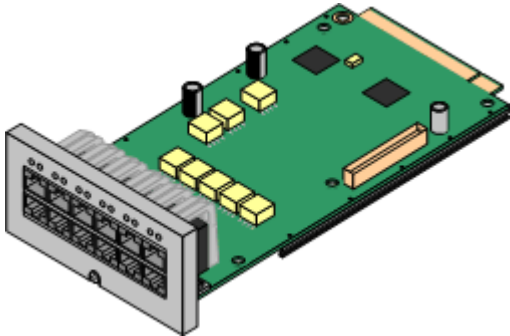

This card provides 8 DS (digital station) ports for the connection of Avaya digital phones.

- The card can be fitted with an [IP500 trunk daughter card](#) which uses the base card ports for trunk connection.
- Maximum: 4 per control unit.
 - Connections for 4100, 7400, M-Series and T-Series phones use the IP500 TCM8 Digital Station card.

[IP500 Analog Phone Base Card](#)

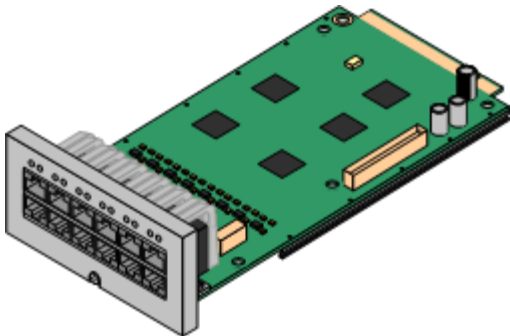

The card is available in two variants, supporting either 2 or 8 analog phone ports.

- The card can be fitted with an [IP500 trunk daughter card](#) which uses the base card ports for trunk connection.
- Maximum: 4 per control unit.
 - The analog phone ports do not include a ringing capacitor. Where this is a requirement, connection should be via a Master socket containing ringing capacitors.
 - If fitted with an IP500 Analog Trunk daughter card, during power failure phone port 8 is connected to analog trunk port 12.

[IP500 TCM8 Digital Station Card](#)

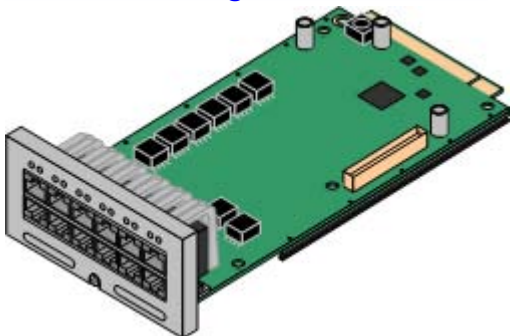

This card provides 8 TCM (digital station) ports for the connection of Avaya 4100, 7400, M-Series and T-Series phones.

- The card can be fitted with an [IP500 trunk daughter card](#) which uses the base card ports for trunk connection.
- Maximum: 4 per control unit per IP500v2 control unit.

[IP500 BRI Combination Card](#)

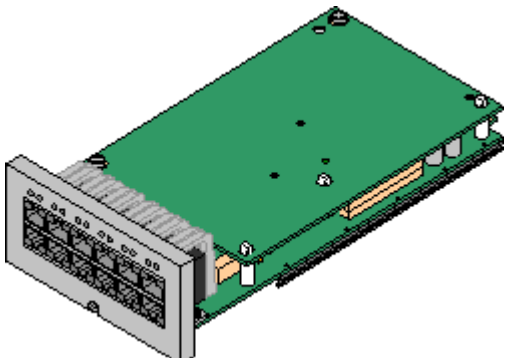

This card provides 6 digital station ports (1-6), 2 analog extension ports (7-8) and 2 BRI trunk ports (9-10, 4 channels). The card also includes 10 voice compression channels.

- This card has a pre-installed [IP500 BRI trunk daughter card](#).
- Maximum: 2 combination cards per IP500v2 control unit, regardless of type.
 - IP Office Essential Edition - Quick Version mode systems are limited to a maximum of 12 BRI channels.

[IP500 ATM Combination Card](#) ¹⁴⁰

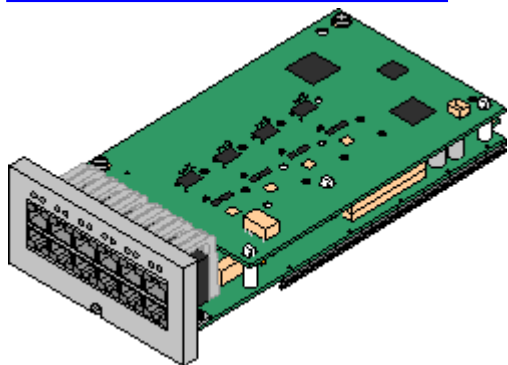

This card provides 6 digital station ports (1-6), 2 analog extension ports (7-8) and 4 analog trunk ports (9-12). The card also includes 10 voice compression channels.

- This card has a pre-installed [IP500 analog trunk daughter card](#) ¹⁷.
- Maximum: 2 combination cards per IP500v2 control unit, regardless of type.
 - The analog phone ports do not include a ringing capacitor. Where this is a requirement, connection should be via a Master socket containing ringing capacitors.
 - If fitted with an IP500 Analog Trunk daughter card, during power failure phone port 8 is connected to analog trunk port 12.

[IP500 ETR6 Base Card](#) ¹⁴³

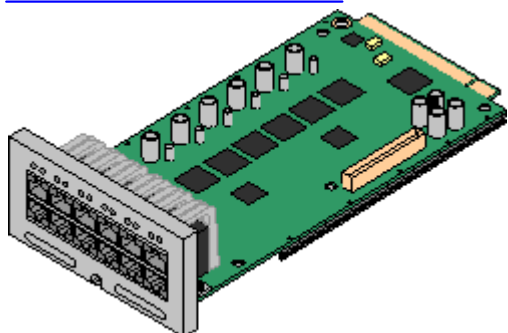

This card is only supported in an IP500v2 control unit running in IP Office Essential Edition - PARTNER® Version or IP Office Essential Edition - Quick Version mode.

It provides 6 ETR ports for connection of ETR phones. 2 Analog extension ports are also provided for emergency use only with an analog trunk card.

- The card can be fitted with an IP500 trunk daughter card which uses the base card ports for trunk connection.
- Maximum: 3 per IP500v2 control unit.
- The analog phone ports do not include a ringing capacitor. Where this is a requirement, connection should be via a Master socket containing ringing capacitors.
- If fitted with an IP500 Analog Trunk daughter card, during power failure phone ports 7 and 8 are connected to analog trunk port 12. However during normal operation analog phone ports 7 and 8 are not useable.

8.2.1 Analog Phone

This card is used to add analog phone ports to an IP500 and IP500v2 control unit. It is available in two variants, providing either 2 or 8 analog extension ports.

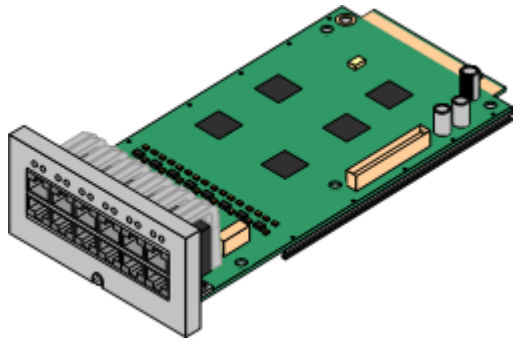

- Supports
Provides either 8 or 2 [analog](#) phone ports depending on card variant.
- IP500 Control Unit: ✓
- IP500v2 Control Unit: ✓
- Maximum per Control Unit: 4.
- IP500 Trunk Card Support: ✓ 1.

Port Type	Ports	Features
Analog Extension	1 to 8	<ul style="list-style-type: none"> • Supports ICLID modes DTMFA, DTMFC, DTMFD, FSK and UK20. • REN 2 (1 for external bell device). • Off-Hook current: 25mA • Ring Voltage: 40V. • Intended for connection to two-wire analog phones, the ports do not include a ringing capacitor. For connection to 4-wire analog phones, connection should be via a master socket with ringing capacitors. • If fitted with an analog trunk card, for the Phone 8, during power failure extension port 8 is connected to the analog trunk port 12. <p>Port LEDs</p> <ul style="list-style-type: none"> • No status LEDs are used for analog phone extensions. • LED1 is also used for base card status: <ul style="list-style-type: none"> • Red On = Error • Red Flash every 5 seconds = Card okay. • Red Slow Flash = Initializing. • Red Fast Flash = System shutdown.
Optional Trunk Card Ports	9 to 12	<p>The card can be fitted with one trunk daughter card of any type. The trunk daughter card then uses ports 9 to 12 on the base card for its trunk connections.</p> <p>Port LEDs</p> <p>LED use depends daughter card type fitted.</p> <ul style="list-style-type: none"> • LED 9 is also used for daughter card status. <ul style="list-style-type: none"> • Red On = Error • Red Flash every 5 seconds = Card okay. • Red Slow Flash = Initializing. • Red Fast Flash = System shutdown. <p>Analog Card</p> <ul style="list-style-type: none"> • Green on = Card fitted. • Green flashing = Trunk in use. <p>PRI Card</p> <ul style="list-style-type: none"> • Off = No trunk present. • Green on = Trunk present. • Green flashing = Trunk in use. • Red/Green Fast Flash (port 9) or Green Fast Flash (port 10) = Alarm indication signal (AIS) from the trunk remote end. • Red with Green Blink (port 9) or Green Blink (port 10) = Port in loopback mode (set through IP Office System Monitor). <p>BRI Card</p> <ul style="list-style-type: none"> • Off = No trunk present. • Green on = Trunk present. • Green flashing = Trunk in use.

Name	Description	SAP Code
I PO 500 Extn Card Phone 2	IP Office 500 Extension Card Phone 2	700431778
I PO 500 Extn Card Phone 8	IP Office 500 Extension Card Phone 8	700417231

8.2.2 ATM Combination Card

This card is used to add a combination of ports to an IP500v2 control unit. Not supported by IP500 control units.

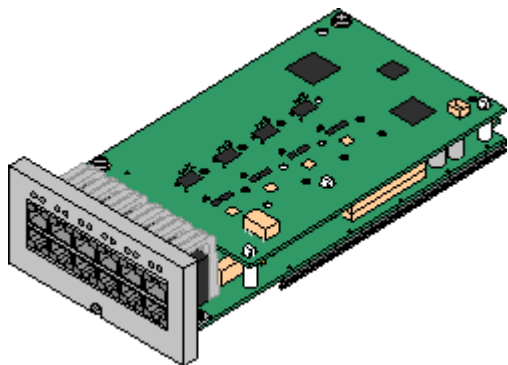

- Supports
 - 6 Digital Station ports.
 - 2 Analog Extension ports.
 - 4 Analog Trunk ports.
 - 10 voice compression channels.
- IP500 Control Unit: ❌
- IP500v2 Control Unit: ✅
- Maximum per Control Unit: 2 combination cards of any type per IP500v2 control unit.
- IP500 Trunk Card Support: ✅ 1. The trunk daughter card is pre-installed and cannot be replaced with another card type.

Port Type	Ports	Features
Digit Station	1 to 6	<p>Provides DS ports for digital stations (except 4100, 4400, 7400, M and T-Series).</p> <p>LEDs</p> <ul style="list-style-type: none"> • Green On = Phone detected. • LED1 is also used for base card status: <ul style="list-style-type: none"> • Red On = Error • Red Flash every 5 seconds = Card okay. • Red Slow Flash = Initializing. • Red Fast Flash = System shutdown.
Analog Extension	7 to 8	<ul style="list-style-type: none"> • Supports ICLID modes DTMFA, DTMFC, DTMFD, FSK and UK20. • REN 2 (1 for external bell device). • Off-Hook current: 25mA • Ring Voltage: 40V. • Intended for connection to two-wire analog phones, the ports do not include a ringing capacitor. For connection to 4-wire analog phones, connection should be via a master socket with ringing capacitors. • During power failure extension port 8 is connected to the analog trunk port 12. • No status LEDs are used for analog phone extensions.
Analog Trunk	9 to 12	<ul style="list-style-type: none"> • DTMF, ICLID, Busy tone detection. • Over-voltage and lightning protection. • DTMF and LD dialing. • Adjustable echo cancellation (default 16ms). Selectable to Off, 8, 16, 32, 64 and 128 milliseconds. <p>LEDs</p> <ul style="list-style-type: none"> • Green on = Card fitted. • Green flashing = Trunk in use. • LED 9 is also used for daughter card status. <ul style="list-style-type: none"> • Red On = Error • Red Flash every 5 seconds = Card okay. • Red Slow Flash = Initializing. • Red Fast Flash = System shutdown.

Name	Description	SAP Code
IPO IP500v2 COMBINATION CARD ATM	IPO IP500v2 COMBINATION CARD ATM	700476013

8.2.3 BRI Combination Card

This card is used to add a combination of ports to an IP500v2 control unit. Not supported by IP500 control units.

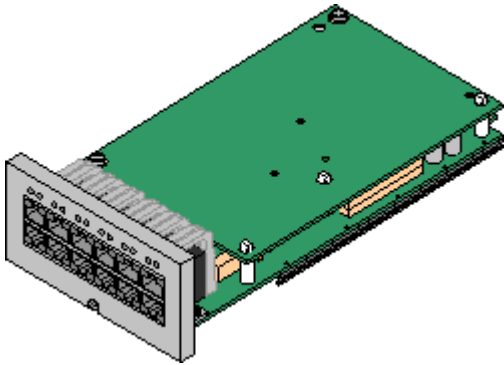

- Supports
 - 6 Digital Station ports.
 - 2 Analog Extension ports.
 - 2 BRI Trunk ports (4 BRI channels).
 - 10 voice compression channels.
- IP500 Control Unit: ✗
- IP500v2 Control Unit: ✓
- Maximum per Control Unit: 2 combination cards of any type.
 - IP Office Essential Edition - Quick Version mode systems are limited to a maximum of 12 BRI channels.
- IP500 Trunk Card Support: ✓ 1. The trunk daughter card is pre-installed and cannot be replaced with another card type.

Port Type	Ports	Features
Digit Station	1 to 6	Provides DS ports for digital stations (except 4100, 4400, 7400, M and T-Series). LEDs <ul style="list-style-type: none"> • Green On = Phone detected. • LED1 is also used for base card status: <ul style="list-style-type: none"> • Red On = Error • Red Flash every 5 seconds = Card okay. • Red Slow Flash = Initializing. • Red Fast Flash = System shutdown.
Analog Extension	7 to 8	<ul style="list-style-type: none"> • Supports ICLID modes DTMFA, DTMFC, DTMFD, FSK and UK20. • REN 2 (1 for external bell device). • Off-Hook current: 25mA • Ring Voltage: 40V. • Intended for connection to two-wire analog phones, the ports do not include a ringing capacitor. For connection to 4-wire analog phones, connection should be via a master socket with ringing capacitors. • No status LEDs are used for analog phone extensions.
BRI Trunk	9 to 10	<ul style="list-style-type: none"> • Each trunk port supports 2B+D channels. • ETSI or AusTS013 basic rate protocol set through the IP Office configuration. LEDs <ul style="list-style-type: none"> • Off = No trunk present. • Green on = Trunk present. • Green flashing = Trunk in use. • LED 9 is also used for daughter card status. <ul style="list-style-type: none"> • Red On = Error • Red Flash every 5 seconds = Card okay. • Red Slow Flash = Initializing. • Red Fast Flash = System shutdown.
Not Used	11 to 12	–

Name	Description	SAP Code
IPO IP500v2 COMBINATION CARD BRI	IPO IP500v2 COMBINATION CARD BRI	700476021

8.2.4 Digital Station

This card is used to add digital station (DS) extension ports to an IP500 and IP500v2 control unit. It provides 8 RJ45 DS extension ports for use with Avaya digital phones. A further 4 RJ45 ports are provided for trunk connections when an IP500 trunk card is fitted to this card.

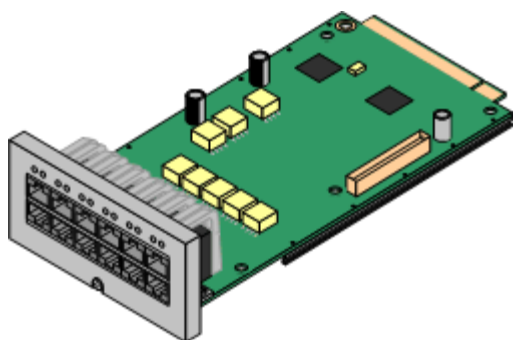

- Supports
Provides 8 [DS](#) ports for [digital stations](#) (except 4100, 4400, 7400, M and T-Series).
- IP500 Control Unit: ✓
- IP500v2 Control Unit: ✓
- Maximum per Control Unit: 4 per control unit.
- IP500 Trunk Card Support: ✓ 1.

Port Type	Ports	Features
Digit Station	1 to 8	<p>Provides DS ports for digital stations (except 4100, 4400, 7400, M and T-Series).</p> <p>LEDs</p> <ul style="list-style-type: none"> • Green On = Phone detected. • LED1 is also used for base card status: <ul style="list-style-type: none"> • Red On = Error • Red Slow Flash = Initializing. • Red Flash every 5 seconds = Card okay. • Red Fast Flash = System shutdown.
Optional Trunk Card Ports	9 to 12	<p>The card can be fitted with one trunk daughter card of any type. The trunk daughter card then uses ports 9 to 12 on the base card for its trunk connections.</p> <p>Port LEDs</p> <p>LED use depends daughter card type fitted.</p> <ul style="list-style-type: none"> • LED 9 is also used for daughter card status. <ul style="list-style-type: none"> • Red On = Error • Red Slow Flash = Initializing. • Red Flash every 5 seconds = Card okay. • Red Fast Flash = System shutdown. <p>Analog Card</p> <ul style="list-style-type: none"> • Green on = Card fitted. • Green flashing = Trunk in use. <p>PRI Card</p> <ul style="list-style-type: none"> • Off = No trunk present. • Green on = Trunk present. • Green flashing = Trunk in use. • Red/Green Fast Flash (port 9) or Green Fast Flash (port 10) = Alarm indication signal (AIS) from the trunk remote end. • Red with Green Blink (port 9) or Green Blink (port 10) = Port in loopback mode (set through IP Office System Monitor). <p>BRI Card</p> <ul style="list-style-type: none"> • Off = No trunk present. • Green on = Trunk present. • Green flashing = Trunk in use.

Name	Description	SAP Code
IPO 500 Extn Card Dgtl Sta 8	IP Office 500 Extension Card Digital Station 8	700417330

8.2.5 ETR6 Card

This card is used to add 6 ETR phone extension ports to an IP500v2 control unit. This card is only supported by IP500v2 systems running in IP Office Essential Edition - PARTNER® Version, IP Office Essential Edition - Norstar Version or IP Office Essential Edition - Quick Version mode.

It also includes 2 analog extension ports which are for emergency use only when the card is fitted with an analog trunk daughter card. A further 4 RJ45 ports (9 to 12) are provided for trunk connections when an IP500 trunk daughter card is fitted to this card.

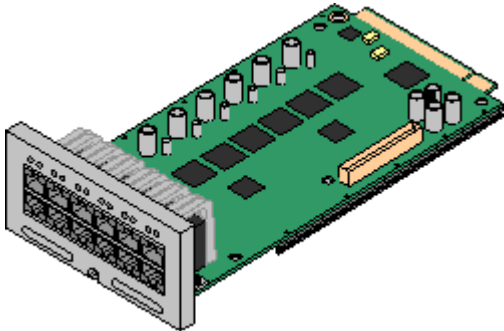

- Supports ETR and analog phones. Each ETR phone can be used for an ETR or analog phone. Support for ETR 34D phone is limited to a maximum of 2 per ETR6 card and 4 in total.
- IP500 Control Unit: ❌
- IP500v2 Control Unit: ✔️
- Maximum per Control Unit: 3.
- IP500 Trunk Card Support: ✔️ 1.
The IP500 BRI trunk daughter card is not supported.

Port Type	Ports	Features
ETR Extensions	1 to 6	<ul style="list-style-type: none"> • REN 1. • DTMF dialing only. • Message waiting indication 51V stepped. • ICLID mode Bellcore 202. <p>LEDs</p> <ul style="list-style-type: none"> • No status LED are used for ETR ports. • LED1 is also used for base card status: <ul style="list-style-type: none"> <li style="width: 50%;">• Red On = Error <li style="width: 50%;">• Red Flash every 5 seconds = Card okay. <li style="width: 50%;">• Red Slow Flash = Initializing. <li style="width: 50%;">• Red Fast Flash = System shutdown.
EF	7 to 8	<ul style="list-style-type: none"> • If fitted with an IP500 Trunk Daughter card, during power failure both these ports are connected to analog trunk port 12. • Supports ICLID modes DTMFA, DTMFC, DTMFD, FSK and UK20. • REN 2 (1 for external bell device). • Off-Hook current: 25mA • Ring Voltage: 40V. • Intended for connection to two-wire analog phones, the ports do not include a ringing capacitor. For connection to 4-wire analog phones, connection should be via a master socket with ringing capacitors. • No status LEDs are used for analog phone extensions.
Optional Trunk Ports	9 to 12	<p>Depends on the type of trunk daughter card fitted. The ETR6 can be fitted with either a Analog Trunk ^[14b] card or PRI Trunk ^[14b] card.</p> <p>LEDs</p> <p>LED use depends daughter card type fitted.</p> <ul style="list-style-type: none"> • LED 9 is also used for daughter card status. <ul style="list-style-type: none"> <li style="width: 50%;">• Red On = Error <li style="width: 50%;">• Red Flash every 5 seconds = Card okay. <li style="width: 50%;">• Red Slow Flash = Initializing. <li style="width: 50%;">• Red Fast Flash = System shutdown. <p>Analog Card</p> <ul style="list-style-type: none"> • Green on = Card fitted. • Green flashing = Trunk in use. <p>PRI Card</p> <ul style="list-style-type: none"> • Off = No trunk present. • Green on = Trunk present. • Green flashing = Trunk in use. • Red/Green Fast Flash (port 9) or Green Fast Flash (port 10) = Alarm indication signal (AIS) from the trunk remote end. • Red with Green Blink (port 9) or Green Blink (port 10) = Port in loopback mode (set through IP Office System Monitor).

Name	Description	SAP Code
IPO IP500v2 EXTN CARD ETR6	IPO IP500v2 EXTN CARD ETR6	700476039

8.2.6 TCM8 Digital Station

This card is used to add [TCM RJ45](#)^[209] extension ports to an IP500v2 control unit. It provides 8 RJ45 extension ports for supported M-Series and T-Series digital stations. It can also be used for 4100 and 7400 Series phone support by connection to a [Digital Mobility Solution](#)^[187] system.

A further 4 RJ45 ports are provided for trunk connections when an IP500 trunk card is fitted to this card.

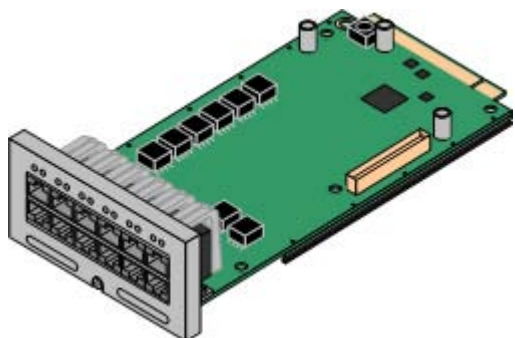

- Supports
Provides 8 [TCM](#)^[209] ports for supported 4100, 4400, 7400, M and T-Series digital stations.
- IP500 Control Unit: ❌
- IP500v2 Control Unit: ✔️
- Maximum per Control Unit: 4.
- IP500 Trunk Card Support: ✔️ 1.

Port Type	Ports	Features
TCM	1 to 8	<p>Cable lengths up to 305 m (1000 ft) using 0.5mm (24AWG) wires do not require a power booster. Lengths up to 790 m (2600 ft) are supported if an auxiliary power supply booster is used.</p> <p>LEDs</p> <ul style="list-style-type: none"> • Green On = Phone detected. • LED1 is also used for base card status: <ul style="list-style-type: none"> • Red On = Error • Red Slow Flash = Initializing. • Red Flash every 5 seconds = Card okay. • Red Fast Flash = System shutdown.
Optional Trunk Card Ports	9 to 12	<p>The card can be fitted with one trunk daughter card of any type. The trunk daughter card then uses ports 9 to 12 on the base card for its trunk connections.</p> <p>LEDs</p> <p>LED use depends daughter card type fitted.</p> <ul style="list-style-type: none"> • LED 9 is also used for daughter card status. <ul style="list-style-type: none"> • Red On = Error • Red Slow Flash = Initializing. • Red Flash every 5 seconds = Card okay. • Red Fast Flash = System shutdown. <p>Analog Card</p> <ul style="list-style-type: none"> • Green on = Card fitted. • Green flashing = Trunk in use. <p>PRI Card</p> <ul style="list-style-type: none"> • Off = No trunk present. • Green on = Trunk present. • Green flashing = Trunk in use. • Red/Green Fast Flash (port 9) or Green Fast Flash (port 10) = Alarm indication signal (AIS) from the trunk remote end. • Red with Green Blink (port 9) or Green Blink (port 10) = Port in loopback mode (set through IP Office System Monitor). <p>BRI Card</p> <ul style="list-style-type: none"> • Off = No trunk present. • Green on = Trunk present. • Green flashing = Trunk in use.

Name	Description	SAP Code
IPO 500 TCM 8	IP Office 500 TCM 8	700500758

8.3 IP500 Trunk Daughter Cards

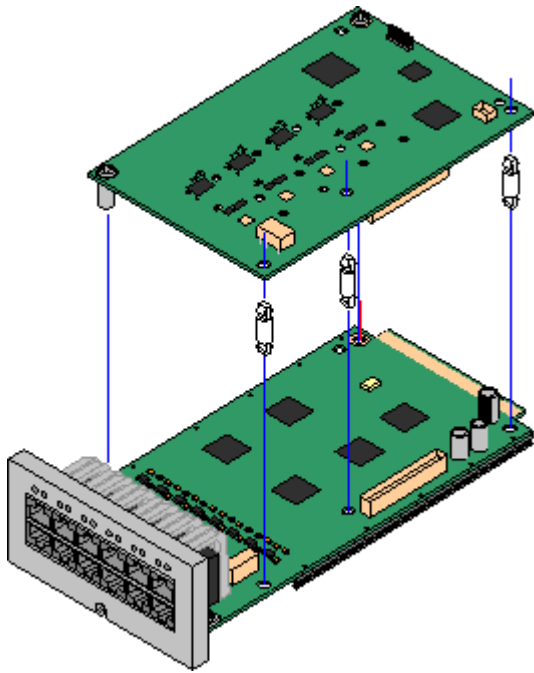

Most [IP500 base cards](#)^[157] can be fitted with an IP500 trunk daughter cards to support the connection of trunks to the base card.

Each daughter card is supplied with the stand off pillars required for installation and a label to identify the daughter cards presence on the front of the base card after installation.

- IP500 Combination cards are pre-fitted with a trunk daughter card which cannot be removed or changed for another type of trunk daughter card.

[IP500 Analog Trunk Daughter Card](#)^[146]

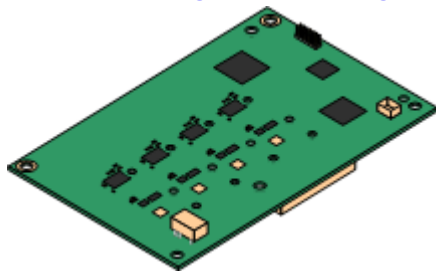

This card allows the base card to support 4 analog loop-start trunks.

- The analog phone ports do not include a ringing capacitor. Where this is a requirement, connection should be via a Master socket containing ringing capacitors.
- If fitted with an IP500 Analog Trunk daughter card, during power failure phone port 8 is connected to analog trunk port 12.
- Maximum: 4 per control unit.

[IP500 PRI-U Trunk Daughter Card](#)^[148]

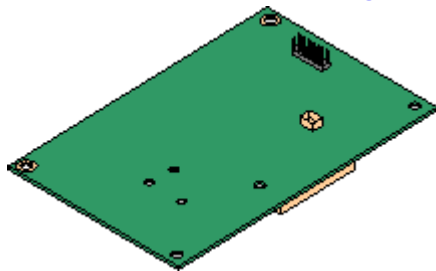

This card allows the base card to support up to 2 PRI trunk connections. The card is available in single and dual port variants. The card can be configured for E1 PRI, T1 robbed bit, T1 PRI or E1R2 PRI trunks.

- Maximum: 1 single port card per control unit.
- The IP Office system supports 8 unlicensed B-channels on each IP500 PRI-U port fitted. Additional B-channels, up to the capacity of ports installed and PRI mode selected require [IP500 Universal PRI \(Additional Channels\)](#)^[212] licenses added to the configuration. These additional channels consume the licenses based on which additional channels are configured as in-service from port 9 of slot 1 upwards. D-channels are not affected by licensing.

[IP500 BRI Trunk Daughter Card](#)^[147]

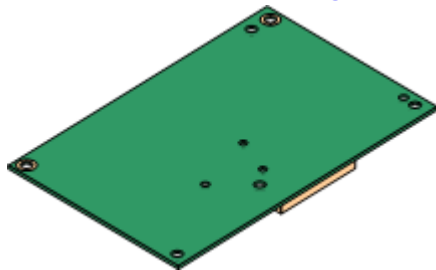

This card allows the base card to support up to 4 BRI trunk connections, each trunk providing 2B+D digital channels. The card is available in 2 port (4 channels) and 4 port (8 channels) variants.

- Maximum: 4 per control unit.
- IP Office Essential Edition - Quick Version mode systems are limited to a maximum of 12 BRI channels.

8.3.1 Analog Trunk Card

This card can be added to an IP500 base card to provide that card with support for 4 loop-start analog trunks.

This card can be fitted to any IP500 base card.

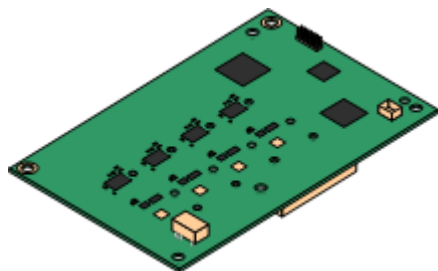

- Ports/Channels
4 Loop-start analog trunk ports. Connections via the host IP500 base card.
- DTMF, ICLID, Busy tone detection.
- Over-voltage and lightning protection (may still require additional protection equipment see [Lightning Protection/Out-of-Building Connections](#) ^[26]).
- DTMF and LD dialing.
- Adjustable echo cancellation (default 16ms). Selectable to Off, 8, 16, 32, 64 and 128 milliseconds.
- Power Failure Port
Regardless of the IP500 card hosting it, during power failure pins 4 and 5 of port 12 are connected to pins 7 and 8. In addition, when fitted to an IP500 Analog Phone 8 base card, during power failure extension port 8 is connected to the analog trunk port 12.
- License: No license required.
- Maximum per Control Unit: 4.
- IP Office Software Level: 4.0+.

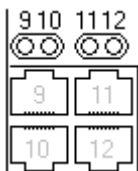

Daughter Card Ports (9-12)

The LEDs for ports 9 to 12 of the IP500 base card are used as follows:

- Green on = Card fitted.
- Green flashing = Trunk in use.
- LED 9 is also used for daughter card status.
 - Red On = Error
 - Red Slow Flash = Initializing.
 - Red Flash every 5 seconds = Card okay.
 - Red Fast Flash = System shutdown.

Name	Description	SAP Code
IPO 500 Trnk Anlg 4 Uni	IP Office 500 Trunk Card Analog 4 Universal	700417405

8.3.2 BRI Trunk Cards

This card can be added to an IP500 base card to provide that card with support for [BRI-To](#)¹⁹⁹⁹ trunks. The card is available in 8 channel (4 physical trunks) or 4 channel (2 physical trunks) variants.

This card can be fitted to any IP500 base card.

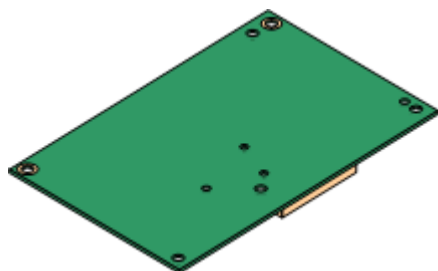

- Ports/Channels
2 or 4 BRI trunk ports. Connections via ports 9 to 12 of the host IP500 base card.
- Each trunk port supports 2B+D channels.
- ETSI or AusTS013 basic rate protocol set through the IP Office configuration.
- License: No license required.
- Maximum per Control Unit: 4.
 - IP Office Essential Edition - Quick Version mode systems are limited to a maximum of 12 BRI channels.
- IP Office Software Level: 4.0+.
- This card is approved for use in the following countries:

Brazil.	New Zealand.
China.	Russia.
India.	South Africa.
Argentina.	United Arab Emirates (UAE).
Australia.	European Union (EU).

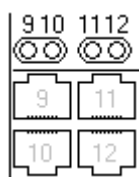

Daughter Card Ports (9-12)

The LEDs for ports 9 to 12 of the IP500 base card are used as follows:

- Off = No trunk present.
- Green on = Trunk present.
- Green flashing = Trunk in use.
- LED 9 is also used for daughter card status.
 - Red On = Error
 - Red Flash every 5 seconds = Card okay.
 - Red Slow Flash = Initializing.
 - Red Fast Flash = System shutdown.

Name	Description	SAP Code
IPO 500 Trnk BRI 4 Uni	IP Office 500 Trunk Card Basic Rate 4 Universal	700417413
IPO 500 Trnk BRI 8 Uni	IP Office 500 Trunk Card Basic Rate 8 Universal	700417421
IPO IP500 BRI S0 CONVTR CBL	IP500 BRI So Converter Cable	700458649

IPO IP500 BRI S0 CONVTR CBL	IP500 BRI So Converter Cable	700458649
-----------------------------	------------------------------	-----------

8.3.3 PRI Trunk Cards

This card can be added to an IP500 base card to provide that card with support for PRI trunks. The card is available in single port or dual port variants.

This card can be fitted to any IP500 base card.

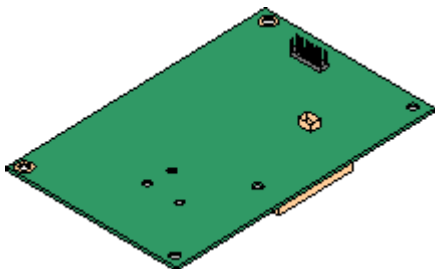

- Ports/Channels
 - 1 or 2 [PRI trunk ports](#) ^[207]. Each port supports the following PRI line types. On dual port cards, both ports will be the same line type. The line type selection can be changed using IP Office Manager. The options available depend on the IP Office operation mode and locale.
 - E1 PRI (30B+D channels per port).
 - E1R2 PRI (30B channels per port).
 - T1 robbed bit (24B channels per port) or T1 PRI (23B+D channels per port).
 - The required mode can be selected within IP Office Manager by right-clicking on the line icon and selecting Change Universal PRI Card Line Type and then selecting the required line type.
 - Physical trunk connection is via ports 9 and 10 of the host IP500 base card.
 - Port 11 and 12 can be used as test points for connection of test and monitoring equipment for the adjacent port.
- Licenses
 - The IP Office system supports 8 unlicensed B-channels on each IP500 PRI-U port fitted. Additional B-channels, up to the capacity of ports installed and PRI mode selected require IP500 Universal PRI (Additional Channels) licenses added to the configuration. These additional channels consume the licenses based on which additional channels are configured as in-service from port 9 of slot 1 upwards. D-channels are not affected by licensing.
- Maximum per Control Unit: 1 single port card per control unit. Not supported in conjunction with BRI trunk cards in the same system.
- Software Level: 4.1+.

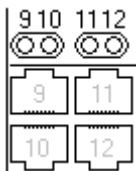

Daughter Card Ports (9-12)

The LEDs for ports 9 to 12 of the IP500 base card are used as follows:

- Off = No trunk present.
- Green on = Trunk present.
- Green flashing = Trunk in use.
- Red/Green Fast Flash (port 9) or Green Fast Flash (port 10) = Alarm indication signal (AIS) from the trunk remote end.
- Red with Green Blink (port 9) or Green Blink (port 10) = Port in loopback mode (set through IP Office System Monitor).
- LED 9 is also used for daughter card status.
 - Red On = Error
 - Red Flash every 5 seconds = Card okay.
 - Red Slow Flash = Initializing.
 - Red Fast Flash = System shutdown.

Name	Description	SAP Code
I PO 500 TRNK PRI 1 UNI	IP Office 500 Trunk Card Primary Rate 1 Universal	700417439
I PO 500 TRNK PRI 2 UNI	IP Office 500 Trunk Card Primary Rate 2 Universal	700417462

8.4 IP500 Expansion Modules

The following IP500 external expansion modules are supported by IP Office Release 7.0. Each module uses an external [power supply unit](#)^[207] supplied with the module. A locale specific [power cord](#)^[217] for the PSU must be ordered separately.

If being rack mounted, these units use the IP500 rack mounting kit. They can be wall mounted using the new wall mounting kit V2.

- Systems running in IP Office Essential Edition - Quick Version mode support up to 8 external expansion modules so long as the system extensions limit is not exceeded.
- [IP500 Digital Station Module](#)^[152]
Provides, depending on variant, an additional 16 or 30 [DS](#)^[208] ports for supported [Avaya DS digital phones](#)^[307].
- [IP500 Digital Station A Module](#)^[154]
Provides, depending on variant, an additional 16 or 30 [TCM](#)^[209] ports for supported [Avaya TCM digital phones](#)^[307]. Supported by IP500v2 only.
- [IP500 Phone Module](#)^[157]
Provides, depending on variant, an additional 16 or 30 [PHONE](#)^[206] ports for analog phones.

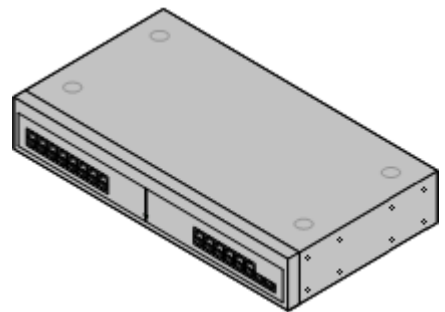
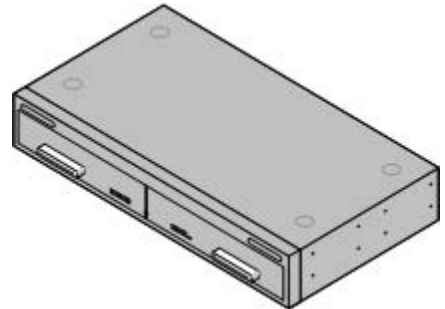
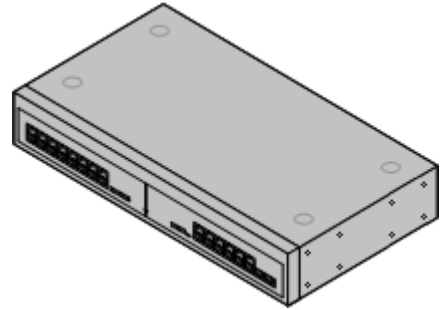

8.4.1 Analog Trunk 16

The IP500 Analog Trunk module can be used to add 16 additional analog trunks to an IP Office system. The module supports both loop-start and, with suitable grounding, ground-start trunks. This module is only supported in the North American locales.

- In IP Office Essential Edition - Quick Version modes, only 1 Analog Trunk module is supported.
- **IMPORTANT**
In all IP Office installations, any module being used for analog trunk connections must be connected to a [functional earth](#) [25].
- **WARNING** ⚠
Within areas of high lightning risk, any module using analog trunk connections must be connected to a [protective ground](#) [25] and to [surge protection equipment](#) [26] (an Avaya 146G Surge Protector).

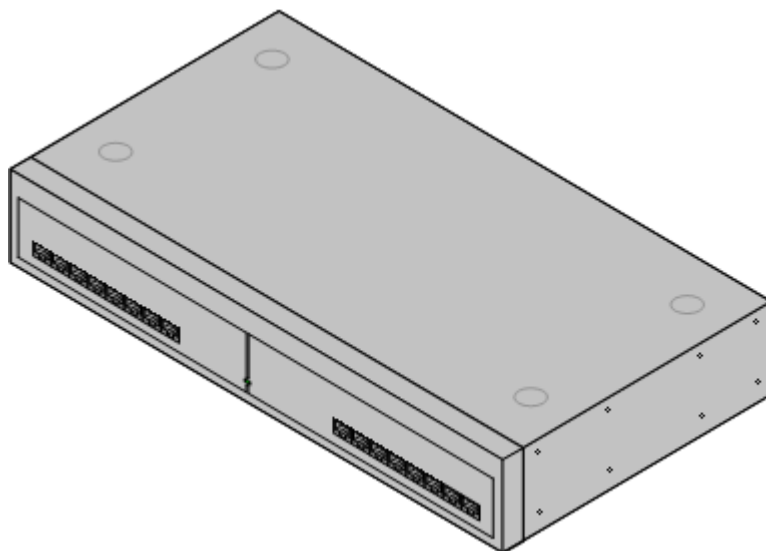

Feature	Details
Supported on	IP500 and IP500v2.
Locales	This module is currently only supported in North American locales.
Software Level	IP Office core software level 1.0 minimum. Bin file = naatm16.bin.
Included	Power supply unit (see below) and Expansion Interconnect cable.
Power Supply	The module is supplied with a 2-pin, 40W external power supply unit. The PSU has an integral power cord for connection to the module's DC I/P socket. A locale specific IEC60320 C7 power cord [20] for the external PSU is required but is not supplied with the module.
Mounting	The module is designed as a free-standing module that can be stacked on or under other IP Office modules. The module can be rack mounted in a 19" rack system using the optional IP500 Rack Mounting Kit. It can be wall mounted using the IP500 Wall Mounting Kit V2.
Dimensions	Width: 445mm/17.5". Depth: 245mm/9.7". Height: 71mm/2.8"/2U.
Weight	Unboxed: 2.9Kg/6.6lbs. Boxed: 4.2Kg/9.4lbs.

IPO 500 Analog Trunk Module Connections

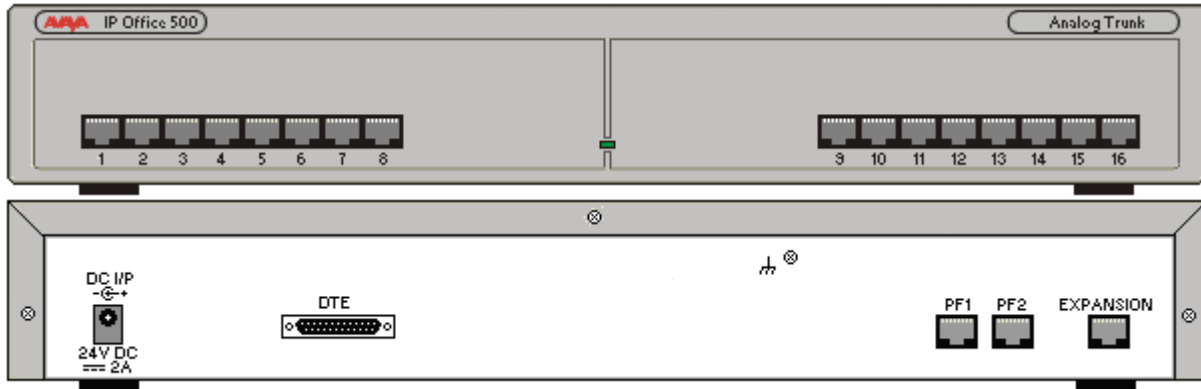

Ports	Description
ANALOG ^(19b)	RJ45 socket. Used for connection to analog trunks. Ports can be configured as either loop-start or ground-start trunks through the IP Office configuration. In the event of power failure, Analog ports 1 and 2 are directly connected to analog extension ports PF1 and PF2 respectively. If used the connected phones must be clearly labeled as power failure devices. This is only supported for loop-start analog trunks.
DC I/P ^(20b)	DC power input port. Used for connection of the power lead from an Avaya 40W external power supply unit supplied with the expansion module. A locale specific IEC60320 C7 power cord ⁽²⁰⁾ for the external PSU is required but is not supplied with the module.
DTE ⁽¹⁰⁷⁾	25-Way D-Type socket. For Avaya use only.
EXPANSION ⁽²⁰⁵⁾	RJ45 Socket. Used for direct connection to an Expansion port on an IP Office control unit using the Expansion Interconnect cable supplied with the module.
PF ⁽²⁰⁵⁾	RJ45 socket. Power failure analog extension ports. See Analog section above.
	Ground point. Used for connection of a functional earth ⁽²⁵⁾ if required. On older modules where this screw is not present, the top-center cover screw should be used instead. <ul style="list-style-type: none"> • IMPORTANT In all IP Office installations, any module being used for analog trunk connections must be connected to a functional earth ⁽²⁵⁾. • WARNING Within areas of high lightning risk, any module using analog trunk connections must be connected to a protective ground ⁽²⁵⁾ and to surge protection equipment ⁽²⁶⁾.

All expansion modules are supplied with a base software level and should be upgraded to match the core software of the control unit in the IP Office system.

Item	Variant	Country	SAP Code
IPO 500 Analog Trunk 16	America	America	700449473
IEC60320 C7 Power Cord	NEMA1-15	America	700213390
			
IP500 Wall Mounting Kit V2		All	700500923
IP500 Rack Mounting Kit		All	700429202

Expansion modules include an external power supply unit (PSU) and an appropriate interconnect cable. They do not include a locale specific power cord for the external PSU or any phone extension cables.

8.4.2 Digital Station

IP Office 500 Digital Station modules can be used to add additional DS ports to an IP Office system. The module is available in 16 and 30 port variants, referred to as the IP500 Digital Station 16 and IP500 Digital Station 30 respectively.

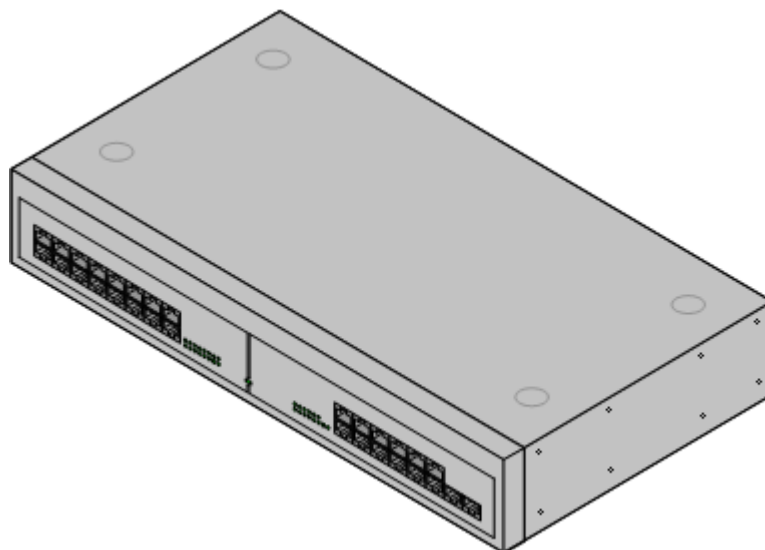

Feature	Details
Supported on	IP500 and IP500v2.
Locales	Supported in all IP Office locales.
Software Level	IP Office core software level 2.1(31) minimum. Bin file = nadcpV2.bin.
Included	Power supply unit (see below) and Expansion Interconnect cable.
Power Supply	The module is supplied with a Earthed 3-Pin, 60W external power supply module. The PSU has an integral power cord for connection to the module's DC I/P socket. A locale specific IEC60320 C13 power cord for the external PSU is required but is not supplied with the module.
Mounting	The module is designed as a free-standing module that can be stacked on or under other IP Office modules. The module can be rack mounted in a 19" rack system using the optional IP500 Rack Mounting Kit. It can be wall mounted using the IP500 Wall Mounting Kit V2.
Dimensions	Width: 445mm/17.5". Depth: 245mm/9.7". Height: 71mm/2.8".
Weight	Unboxed: 3.5Kg/7.8lbs. Boxed: 4.8Kg/10.8lbs. (Based on DS30 V2)

IPO 500 Digital Station Connections

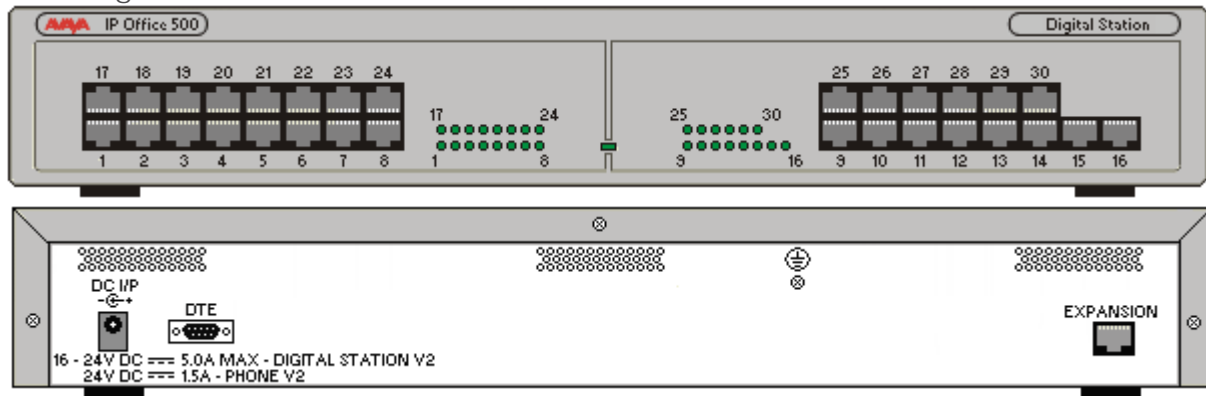

Ports	Description
DC I/P ^[206]	DC power input port. Used for connection of the power lead from an Avaya earthed 60W external power supply unit supplied with the expansion module. A locale specific IEC60320 C13 power cord ^[207] for the external PSU is required but is not supplied with the module.
DS ^[206]	RJ45 socket. Digital Station port. Used for connection of IP Office supported DS phones ^[30] . If connected to an out-of-building extension ^[26] , the connection must be made via additional IROB barrier devices in addition to the buildings primary protection. The module must also be connected to a protective ground.
DTE ^[107]	9-Way D-Type socket. For Avaya use only.
EXPANSION ^[203]	RJ45 Socket. Used for direct connection to an Expansion port on an IP Office control unit using the Expansion Interconnect cable supplied with the module.
	Protective Ground point. Use of a protective ground is required for all installations, see Grounding (Earthing) ^[73] . Where the module is connected to analog extensions in another building, an IP Office Phone Barrier Box V2 (101V) is required at both ends, see Lightning Protection/Out-of-Building Connections ^[26] .

All expansion modules are supplied with a base software level and should be upgraded to match the core software of the control unit in the IP Office system.

Item	Variant	Country	SAP Code
IPO 500 Digital Station	16 Ports	All	700449499
	30 Ports		700426216
 IEC60320 C13 Power Cord	CEE7/7	Europe	700289762
	BS1363	United Kingdom	700289747
	NEMA5-15P	America	700289770
IP500 Wall Mounting Kit V2		All	700500923
IP500 Rack Mounting Kit		All	700429202

Expansion modules include an external power supply unit (PSU) and an appropriate interconnect cable. They do not include a locale specific power cord for the external PSU or any phone extension cables.

8.4.3 Digital Station A

IP Office 500 Digital Station A modules can be used to add additional [TCM](#) ports to an IP Office system. They provides extension ports for supported M-Series and T-Series digital stations. They can also be used for 4100 and 7400 Series phone support by connection to a [Digital Mobility Solution](#) system.

The module is available in 16 and 30 port variants, referred to as the IP500 Digital Station 16A and IP500 Digital Station 30A respectively. Connection is via 1 (16 port version) or 2 (30 port version) J21 connectors.

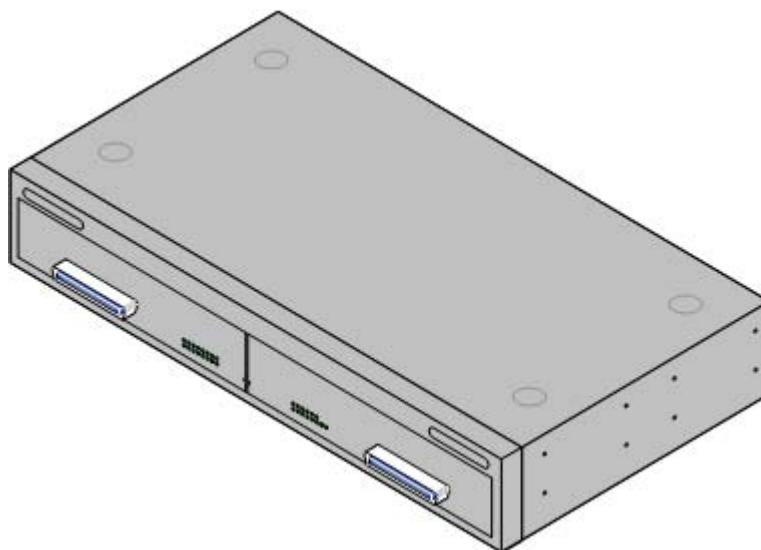

Feature	Details
Supported on	IP500v2 only.
Locales	Supported in all IP Office locales.
Software Level	IP Office core software level 7.0 minimum. Bin file = nadcpaV1.bin.
Included	Power supply unit (see below) and Expansion Interconnect cable.
Power Supply	The module is supplied with a Earthed 3-Pin, 60W external power supply module. The PSU has an integral power cord for connection to the module's DC I/P socket. A locale specific IEC60320 C13 power cord for the external PSU is required but is not supplied with the module.
Mounting	The module is designed as a free-standing module that can be stacked on or under other IP Office modules. The module can be rack mounted in a 19" rack system using the optional IP500 Rack Mounting Kit. It can be wall mounted using the IP500 Wall Mounting Kit V2.
Dimensions	Width: 445mm/17.5". Depth: 245mm/9.7". Height: 71mm/2.8".
Weight	Unboxed: 3.5Kg/7.8lbs. Boxed: 4.8Kg/10.8lbs. (Based on DS30A)

IPO 500 Digital Station A Connections

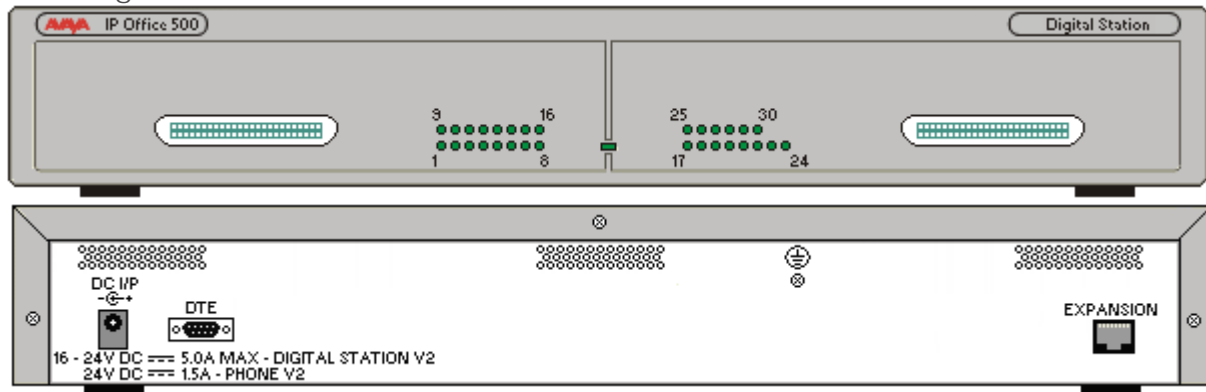

LEDs 1 to 16 or 1 to 30 indicate when a phone is connected. They do not indicate phone activity. The center LED indicate the module status (Green = Okay, Red = Error, Flashing = Loading firmware).

Ports	Description
DC I/P ^[20b]	DC power input port. Used for connection of the power lead from an Avaya earthed 60W external power supply unit supplied with the expansion module. A locale specific IEC60320 C13 power cord ^[20] for the external PSU is required but is not supplied with the module.
TCM RJ21 ^[20b]	RJ21 port. Provides extension ports for supported M-Series and T-Series digital stations. They can also be used for 4100 and 7400 Series phone support by connection to a Digital Mobility Solution ^[18a] system.
DTE ^[10a]	9-Way D-Type socket. For Avaya use only.
EXPANSION ^[20b]	RJ45 Socket. Used for direct connection to an Expansion port on an IP Office control unit using the Expansion Interconnect cable supplied with the module.
	Protective Ground point. Use of a protective ground is required for all installations, see Grounding (Earthing) ^[7a] . Where the module is connected to analog extensions in another building, an IP Office Phone Barrier Box V2 (101V) is required at both ends, see Lightning Protection/Out-of-Building Connections ^[26] .

All expansion modules are supplied with a base software level and should be upgraded to match the core software of the control unit in the IP Office system.

Item	Variant	Country	SAP Code
IP500 Digital Station A	16 Ports	All	700500699
	30 Ports		700500698
 IEC60320 C13 Power Cord	CEE7/7	Europe	700289762
	BS1363	United Kingdom	700289747
	NEMA5-15P	America	700289770
IP500 Wall Mounting Kit V2			700500923
IP500 Rack Mounting Kit		All	700429202

Expansion modules include an external power supply unit (PSU) and an appropriate interconnect cable. They do not include a locale specific power cord for the external PSU or any phone extension cables.

RJ21 Cable Pin Out

The following pin-out is used for the RJ21 ports.

1st RJ21 Connector

Port		Pin	Wire
1	Tip	26	White/Blue
	Ring	1	Blue/White
2	Tip	27	White/Orange
	Ring	2	Orange/White
3	Tip	28	White/Green
	Ring	3	Green/White
4	Tip	29	White/Brown
	Ring	4	Brown/White
5	Tip	30	White/Slate
	Ring	5	Slate/White
6	Tip	31	Red/Blue
	Ring	6	Blue/Red
7	Tip	32	Red/Orange
	Ring	7	Orange/Red
8	Tip	33	Red/Green
	Ring	8	Green/Red
9	Tip	34	Red/Brown
	Ring	9	Brown/Red
10	Tip	35	Red/Slate
	Ring	10	Slate/Red
11	Tip	36	Black/Blue
	Ring	11	Blue/Black
12	Tip	37	Black/Orange
	Ring	12	Orange/Black
13	Tip	38	Black/Green
	Ring	13	Green/Black
14	Tip	39	Black/Brown
	Ring	14	Brown/Black
15	Tip	40	Black/Slate
	Ring	15	Slate/Black
16	Tip	41	Yellow/Blue
	Ring	16	Blue/Yellow
Not Used		42	Yellow/Orange
		17	Orange/Yellow
		43	Violet/Slate
		08	Slate/Violet

2nd RJ21 Connector

Port		Pin	Wire
1	Tip	26	White/Blue
	Ring	1	Blue/White
2	Tip	27	White/Orange
	Ring	2	Orange/White
3	Tip	28	White/Green
	Ring	3	Green/White
4	Tip	29	White/Brown
	Ring	4	Brown/White
5	Tip	30	White/Slate
	Ring	5	Slate/White
6	Tip	31	Red/Blue
	Ring	6	Blue/Red
7	Tip	32	Red/Orange
	Ring	7	Orange/Red
8	Tip	33	Red/Green
	Ring	8	Green/Red
9	Tip	34	Red/Brown
	Ring	9	Brown/Red
10	Tip	35	Red/Slate
	Ring	10	Slate/Red
11	Tip	36	Black/Blue
	Ring	11	Blue/Black
12	Tip	37	Black/Orange
	Ring	12	Orange/Black
13	Tip	38	Black/Green
	Ring	13	Green/Black
14	Tip	39	Black/Brown
	Ring	14	Brown/Black
Not Used		40	Black/Slate
		15	Slate/Black
		41	Yellow/Blue
		16	Blue/Yellow
		42	Yellow/Orange
		17	Orange/Yellow
	43	Violet/Slate	
	08	Slate/Violet	

8.4.4 Phone

IP500 Phone modules can be used to add additional PHONE ports to an IP Office system.

The module is available in 16 and 30 port variants, referred to as the IP500 Phone 16 and IP500 Phone 30 respectively.

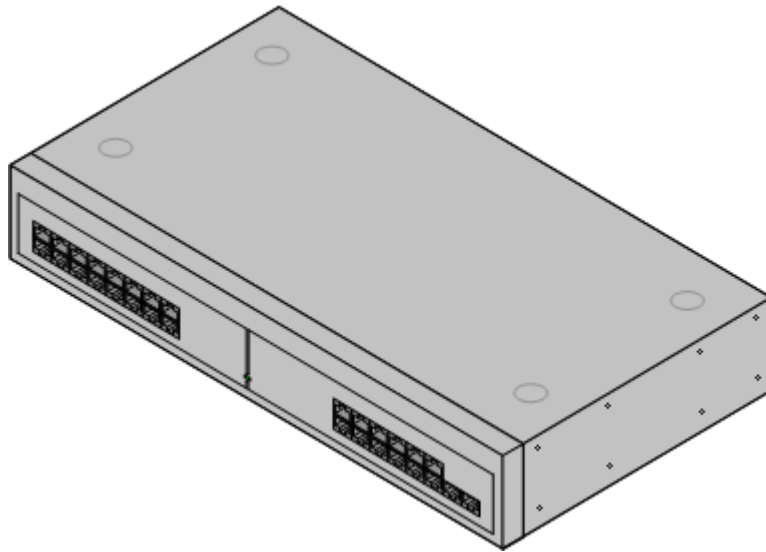

Feature	Details
Supported on	IP500 and IP500v2.
Locales	Supported in all IP Office locales.
Software Level	IP Office core software level 2.1(36) minimum. Bin file = dvpots.bin.
Included	Power supply unit (see below) and Expansion Interconnect cable.
Power Supply	The module is supplied with a Earthed 3-Pin, 60W external power supply unit. The PSU has an integral power cord for connection to the module's DC I/P socket. A locale specific IEC60320 C13 power cord for the external PSU is required but is not supplied with the module.
Mounting	The module is designed as a free-standing module that can be stacked on or under other IP Office modules. The module can be rack mounted in a 19" rack system using the optional IP500 Rack Mounting Kit. It can be wall mounted using the IP500 Wall Mounting Kit V2.
Dimensions	Width: 445mm/17.5". Depth: 245mm/9.7". Height: 71mm/2.8".
Weight	Unboxed: 3.1Kg/6.94lbs. Boxed: 4.4Kg/9.7lbs. (Based on Phone 30 V2)

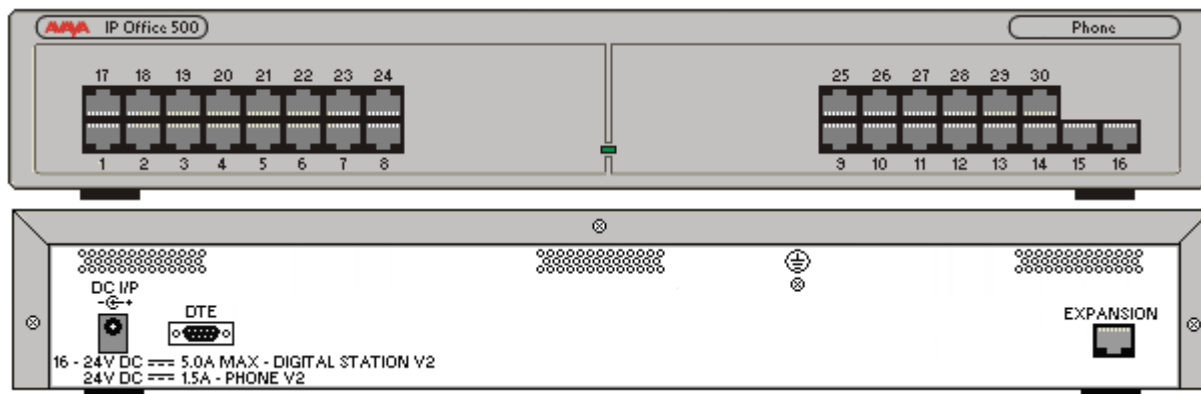

Ports	Description
DC I/P ^[20b]	DC power input port. Used for connection of the power lead from an Avaya earthed 60W external power supply unit supplied with the expansion module. A locale specific IEC60320 C13 power cord ^[20c] for the external PSU is required but is not supplied with the module.
DTE ^[10a]	9-Way D-Type socket. For Avaya use only.
EXPANSION ^[20a]	RJ45 Socket. Used for direct connection to an Expansion port on an IP Office control unit using the Expansion Interconnect cable supplied with the module.
PHONE ^[20b]	RJ45 socket. Used for connection of analog phones. Intended for two-wire analog phones. For connection to 4-wire analog phones connection should be via a master socket with ringing capacitors. If connected to an out-of-building extension ^[26a] , the connection must be made via additional IP Office Barrier Boxes ^[10a] in addition to the buildings primary protection. The module must also be connected to a protective ground.
	Protective Ground point. Use of a protective ground is required for all installations, see Grounding (Earthing) ^[25a] . Where the module is connected to analog extensions in another building, an IP Office Phone Barrier Box V2 (101V) is required at both ends, see Lightning Protection/Out-of-Building Connections ^[28a] .

All expansion modules are supplied with a base software level and should be upgraded to match the core software of the control unit in the IP Office system.

Item	Variant	Country	SAP Code
IPO 500 Phone	16 Ports	All	700449507
	30 Ports	All	700426224
 IEC60320 C13 Power Cord	CEE7/7	Europe	700289762
	BS1363	United Kingdom	700289747
	NEMA5-15P	America	700289770
IP500 Wall Mounting Kit V2			700500923
IP500 Rack Mounting Kit		All	700429202

Expansion modules include an external power supply unit (PSU) and an appropriate interconnect cable. They do not include a locale specific power cord for the external PSU or any phone extension cables.

8.5 Feature Keys

The serial number of the feature key fitted to the IP Office control unit is used as the basis for all licenses issued for that IP Office system and is used to regularly re-validate the licenses. If the feature key is removed, over the next few hours licensed features will stop operating.

8.5.1 IP500v2 System SD Cards

This type of feature key is used with IP500v2 control units and is a mandatory item. The control unit must be fitted with one of these feature keys even if no licenses are being used.

The serial number for licenses issued for use with this type of feature key is printed on the card label and prefixed by FK. This type of feature key is also a memory card used for other system functions and to provide embedded voicemail if required.



- By default the card can be used for 2 ports of embedded voicemail. Additional ports up to a maximum of 6 can be enabled by the addition of [licenses](#) ^[21]. The voicemail mailbox message and prompt capacity supports 2 simultaneous connections and 15 hours of storage. This can be expanded up to 6 channels by the addition of licenses, each of which enables an additional two channels and an additional 5 hours of storage.
-  **WARNING**
These cards should only be formatted using IP Office Manager or IP Office System Status Application. The cards should only be removed from a system after either a [card shut down](#) ^[129] or a [system shut down](#) ^[131].

Feature Key Dongle	SAP Code
IPO IP500 V2 SYS SD CARD A-LAW	700500924
IPO IP500 V2 SYS SD CARD MU-LAW	700500925
IPO IP500 V2 SYS SD CARD PARTNER	700500926
IPO IP500 V2 SYS SD CARD NORSTAR	700500927

- IP Office U-Law
A system fitted with this type of card will default to U-Law telephony. For pre-IP Office Release 7.0 software, the system will default to IP Office standard mode. For IP Office Release 7.0+, the system will default to IP Office Essential Edition - Quick Version mode *Key System* operation. Intended for North American locales.
- IP Office A-Law
A system fitted with this type of card will default to A-Law telephony. For pre-IP Office Release 7.0 software, the system will default to IP Office standard mode. For IP Office Release 7.0+, the system will default to IP Office Essential Edition - Quick Version mode *PBX System* operation. Intended for locales outside North America.
- IP Office Partner Version
A system fitted with this type of card will default to U-Law telephony and IP Office Essential Edition - PARTNER® Version mode *Key System* operation. Supported only in North American locales.
- IP Office Norstar Version
A system fitted with this type of card will default to A-Law telephony and IP Office Essential Edition - Norstar Version mode *Key System* operation. Supported only in Middle East and North African locales.
- Avaya Branch Gateway
This type of SD card intended to be used with <%GATEWAY%> systems. The Avaya Branch Gateway System SD card can only be used for Avaya Branch Gateway operation and cannot be used to change modes to IP Office. You also cannot use or change an IP Office SD card for use with an Avaya Branch Gateway system. Avaya Branch Gateway systems are not covered by this documentation.

PCM Encoding

- A-Law or Mu-Law
PCM (Pulse Code Modulation) is a method for encoding voice as data. In telephony, two methods PCM encoding are widely used, A-law and Mu-law (also called U-law). Typically Mu-law is used in North America and a few other locations while A-law by the rest of the world. As well as setting the correct PCM encoding for the region, the A-Law or Mu-Law setting of an IP Office system when it is first started affects a wide range of regional defaults relating to line settings and other values.
 - For IP400 IP Office systems, each control units was manufactured as either an A-Law variant or a Mu-Law variant.
 - For IP500 and IP500v2 systems, the encoding default is set by the type of Feature Key installed when the system is first started.



8.6 Mounting Kits

The following mounting kits are available for use with IP Office systems.

8.6.1 IP500 Wall Mounting Kits

IP500, IP500v2 control units and IP500 external expansion modules can be wall mounted. To do this, a wall mounting kit is required in addition to suitable wall fixings. Wall mounting is not supported for IP400 external expansion modules.

In addition to the existing [environmental requirements](#)^[38] for an IP Office system, the following additional requirements apply when wall mounting a unit:

- The wall surface must be vertical, flat and vibration free. Attachment to temporary walls is not supported.
- Only the screws provided with the mounting kit should be used to attach the brackets to the control unit.

The following wall mounting kits exist.

- IP500 Wall Mounting Kit V2 (*SAP Code 700500923*)
This kit can be used for wall mounting an IP500 or IP500 v2 control unit and IP500 external expansion modules. This kit incorporates cable routing at the front and rear of the unit. For control units it allows orientation of the control unit base card slots to the left or to the right.

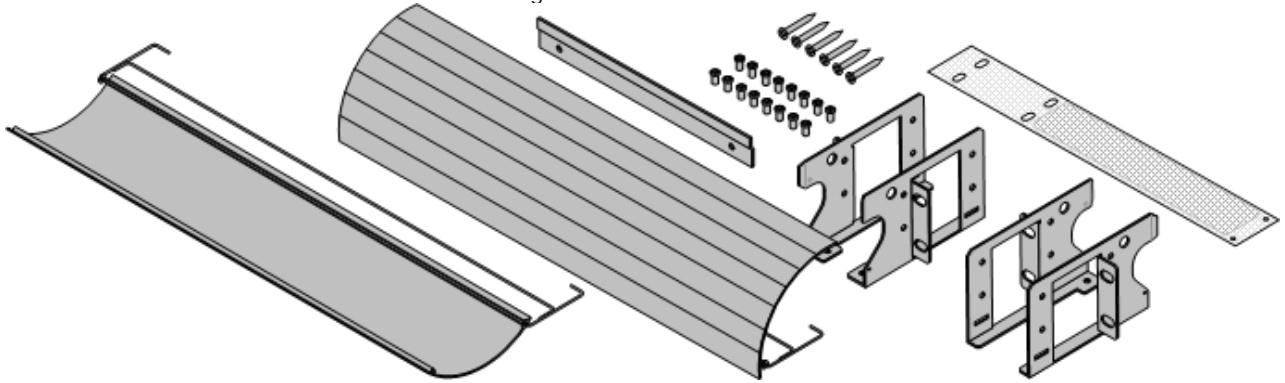

- IP500 Wall Mounting Kit (*SAP Code 700430150*)
This old design of wall mounting kit can be used for wall mounting an IP500 or IP500v2 control units only. It does not provide any cable routing and requires the control unit to be mounted with the base card slots to the right only.

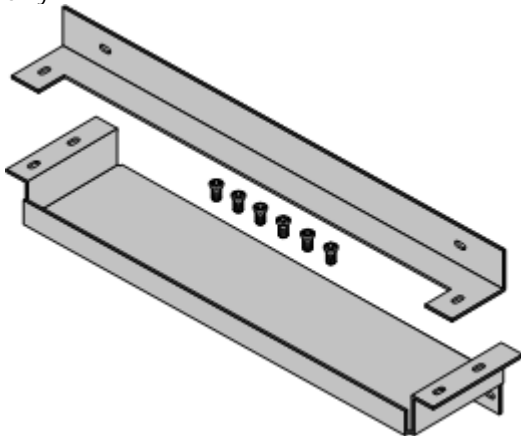

8.6.2 IP500 Rack Mounting Kit

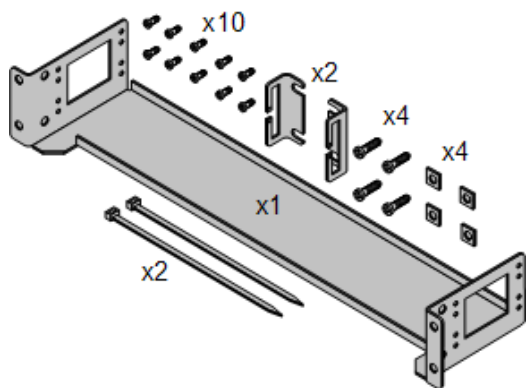

- IP500 Rack Mounting Kit (SAP 700429202)
This kit contains all the components required for the rack mounting of a single IP500v2 control unit, IP500 control unit or IP500 external expansion module. This includes screws for fixing of the brackets to the module, bolts for securing the module in the rack and cable tidy brackets.

8.6.3 IP400 Rack Mounting Kit

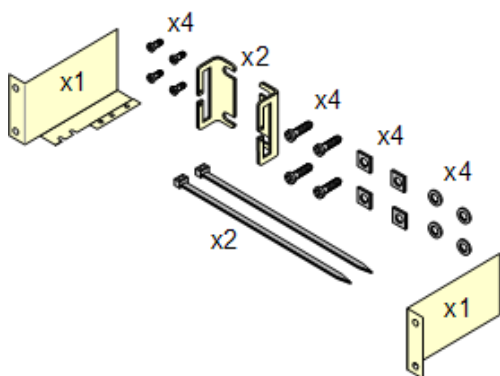

- IP400 Rack Mounting Kit (SAP 700210800)
This kit contains all the components required for the rack mounting of a single control unit or expansion module. This includes screws for fixing of the brackets to the module and bolts for securing the module in the rack.

8.6.4 Barrier Box Rack Mounting Kit

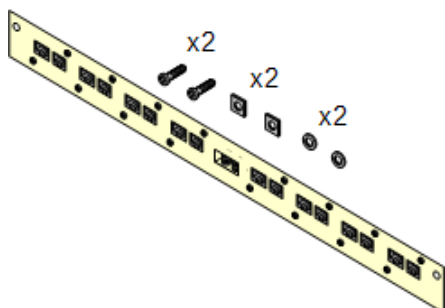

- Barrier Box Rack Mounting Kit (SAP 700293905)
Barrier boxes must be used for [out-of-building analog phone extensions](#)^[28]. This bracket allows up to 8 IP Office barrier boxes to be rack mounted and simplifies the number of connections to the protective ground point in the rack. This kit must be used when more than 3 barrier boxes are in use and supports a maximum of 16 barrier boxes for a single external expansion module.

8.7 Phones

IP Office Release 7.0 supports the following phones and phone add-ons. Availability may depend on location and may be subject to local restrictions.

Enhanced Tip and Ring (ETR Port)

These phones are only supported on an ETR6 card in a IP500v2 systems. The following are supported in IP Office Essential Edition - Quick Version mode.

- ETR Series: [ETR6](#)^[171], [ETR6D](#)^[171], [ETR18](#)^[172], [ETR18D](#)^[172], [ETR34D](#)^[173] (*ETR 34D phones limited to a maximum of 2 per card and 4 in total*)
- PARTNER DECT: [3910](#)^[167], [3920](#)^[167]

Digital Station (DS Port)

These digital stations connect to the IP Office via [DS](#)^[200] ports. The following are supported in IP Office Essential Edition - Quick Version mode.

- 1400 Series: [1403](#)^[164], [1408](#)^[165], [1416](#)^[166]
- 9400 Series: [9404](#)^[168], [9408](#)^[168]
- 9500 Series: [9504](#)^[169], [9508](#)^[169]

Digital Station (TCM Port)

These digital stations connect to the IP500v2 IP Office system via [TCM](#)^[200] ports. The following are supported in IP Office Essential Edition - Quick Version mode.

- 4100 Series: 4135, 4136, 4145, 4145EX, 4146, 4146EX - Connection to IP Office TCM ports via a [Digital Mobility Solution](#)^[187] system.
- 7400 Series: 7420, 7430, 7434, 7439, 7440, 7444, 7449 - Connection to IP Office TCM ports via a [Digital Mobility Solution](#)^[187] system.
- ACU: [Audio Conferencing Unit](#)^[170]
- M-Series: [MT7100](#)^[174], [MT7100N](#)^[174], [MT7208](#)^[175], [MT7208N](#)^[175], [M7310](#)^[176], [M7310N](#)^[176], [M7324](#)^[177], [M7324N](#)^[177]
- T-Series: [T7000](#)^[178], [T7100](#)^[178], [T7208](#)^[179], [T7316](#)^[180], [T7316E](#)^[181], [T7406](#)^[182], [T7406E](#)^[182]

Analog Telephones

Analog phones and devices connect to [PHONE](#)^[200] ports with the IP Office system. However due to the variety of analog phones and device available no guarantee of operation is given. It is the responsibility of the IP Office installer and maintainer to test and verify the operation of proposed analog equipment.

- 6200 Series: 6211, 6219, 6221 (*North America*).
- Interquartz Gemini: 9330-AV, 9335-AV, 9281-AV (*Europe, Middle East, Africa, Asia-Pacific*).

8.7.1 1403

This phone is supported with IP Office Release 6.0 and higher.

1603	Feature	1403
	Connects via	DS port.
	IP Office Release	6.0
	Programmable Buttons	✓ 3
	Headset Socket	✗
	Handsfree Speaker/ Microphone	✓/✓
	Message Waiting Lamp	✓
	Display	2 x 16 backlit.
	Supported Add-Ons	None
	Upgradeable Firmware	✓

Fixed Telephony Function Keys

✓ SPEAKER	✗ HEADSET	✓ MUTE	✓ VOLUME UP	✗ CONTACTS
✗ MESSAGE	✓ HOLD	✓ TRANSFER	✓ VOLUME DOWN	✗ CALL LOG
✓ DROP	✓ REDIAL	✓ CONFERENCE	✓ MENU	

Variant		SAP Code
1403 Telephone	Black	700469927

8.7.2 1408

This phone is supported with IP Office Release 6 and higher.

1408	Feature	1408
	Connects via	DS port.
	IP Office Release	6.0+
	Programmable Buttons	✓ 8
	Headset Socket	✓
	Handsfree Speaker/Microphone	✓/✓
	Message Waiting Lamp	✓
	Display	3 x 24 backlit.
	Supported Add-Ons	None.
Upgradeable Firmware	✓	

Fixed Function Keys

✓ SPEAKER	✓ HEADSET	✓ MUTE	✓ VOLUME UP	✓ CONTACTS
✓ MESSAGE	✓ HOLD	✓ TRANSFER	✓ VOLUME DOWN	✓ CALL LOG
✓ DROP	✓ REDIAL	✓ CONFERENCE	✓ MENU	

Variant		SAP Code
1408 Telephone	Black	700469851

8.7.3 1416

This phone is supported with IP Office Release 6 and higher.

1416	Feature	1416
	Connects via	DS port.
	IP Office Release	6.0+
	Programmable Buttons	✓ 16
	Headset Socket	✓
	Handsfree Speaker/ Microphone	✓/✓
	Message Waiting Lamp	✓
	Display	4 x 24 Backlit.
	Supported Add-Ons	DBM32 ¹⁸⁴ x 3.
	Upgradeable Firmware	✓

Fixed Function Keys				
✓ SPEAKER	✓ HEADSET	✓ MUTE	✓ VOLUME UP	✓ CONTACTS
✓ MESSAGE	✓ HOLD	✓ TRANSFER	✓ VOLUME DOWN	✓ CALL LOG
✓ DROP	✓ REDIAL	✓ CONFERENCE	✓ MENU	

Variant		SAP Code
1416 Telephone	Black	700469869
DBM32 Button Module	Black	700469968

8.7.4 3910

This single station DECT phone is supported on an IP500v2 control unit running in Partner Version mode. The base station uses an ETR port for connection to the IP Office. This phone is no longer available from Avaya and has been superseded by the [3920](#)¹⁶⁷.



8.7.5 3920

This single station DECT phone is supported on an IP500v2 control unit running in Partner Version mode. The base station uses an ETR port for connection to the IP Office.



8.7.6 9404

9400 Series and 9500 Series phones are supported by IP Office Release 7.0 and higher. They are physically and functionally the same, however the 9500 Series models are only supported with IP Office IP500v2 systems.

The phones provide 4 physical buttons with red and green LEDs. These can be used for up to 12 programmable features.

8.7.7 9408

9400 Series and 9500 Series phones are supported by IP Office Release 7.0 and higher. They are physically and functionally the same, however the 9500 Series models are only supported with IP Office IP500v2 systems.

The phones provide 8 physical buttons with red and green LEDs. These can be used for up to 24 programmable features. The phones support the addition of up to 3 BM12 button modules supporting an additional 24 programmable features (using 12 buttons) per module.



8.7.8 9504

9400 Series and 9500 Series phones are supported by IP Office Release 7.0 and higher. They are physically and functionally the same, however the 9500 Series models are only supported with IP Office IP500v2 systems.

The phones provide 4 physical buttons with red and green LEDs. These can be used for up to 12 programmable features.

8.7.9 9508

9400 Series and 9500 Series phones are supported by IP Office Release 7.0 and higher. They are physically and functionally the same, however the 9500 Series models are only supported with IP Office IP500v2 systems.

The phones provide 8 physical buttons with red and green LEDs. These can be used for up to 24 programmable features. The phones support the addition of up to 3 BM12 button modules supporting an additional 24 programmable features (using 12 buttons) per module.



8.7.10 Audio Conferencing Unit

Avaya M and T-Series phones are supported by IP Office Release 7.0 and higher on an IP500v2. They can be connected to digital station ports provided by an IP500 TCM8 base card or on a DS16A/DS30A external expansion module.

The Audio Conferencing Unit (ACU) is a multiple microphone desktop conferencing unit. The Audio Conferencing unit only supports the following Feature codes:

- Speeddial: *Feature 0*
This feature code can be used to dial a stored number.
 - If *Feature 0* is followed by a 3-digit number in the range 000 to 255, the system directory entry with the matching index is dialed.
 - If *Feature 0* is followed by * and a 2-digit number in the range 71 to 94, the personal directory entry with the matching index is dialed.
- Hold/Switch Calls: *Feature 2*
This feature code will hold the current call. If there was already a call on hold, the feature code will switch between calls.
- Conference: *Feature 3*
If the Audio Conferencing Unit has a call connected and another call on hold, using this feature code will conference the unit and those calls.
- Last Number Redial: *Feature 5*
When the phone is idle, this feature code can be used to redial the last number dialed from the Audio Conferencing Unit.

8.7.11 ETR 6, ETR 6D

This phone is supported with IP Office Release 6.0 and higher. It is only supported on an ETR6 card in IP500v2 systems. They are only supported in IP Office Essential Edition - PARTNER® Version, IP Office Essential Edition - Norstar Version and IP Office Essential Edition - Quick Version mode systems running in a North American locale. They are not supported in IP Office Standard mode.

Both 'Refresh' and 'Euro Style' variants of the phones are supported. An additional analog device using the same extension number can be connected via the ETR phone's AUX socket.



8.7.12 ETR 18, ETR 18D

This phone is supported with IP Office Release 6.0 and higher. It is only supported on an ETR6 card in IP500v2 systems. They are only supported in IP Office Essential Edition - PARTNER® Version, IP Office Essential Edition - Norstar Version and IP Office Essential Edition - Quick Version mode systems running in a North American locale. They are not supported in IP Office Standard mode.

Both 'Refresh' and 'Euro Style' variants of the phones are supported. An additional analog device using the same extension number can be connected via the ETR phone's AUX socket.



8.7.13 ETR 34D

This phone is supported with IP Office Release 6.0 and higher. It is only supported on an ETR6 card in IP500v2 systems. They are only supported in IP Office Essential Edition - PARTNER® Version, IP Office Essential Edition - Norstar Version and IP Office Essential Edition - Quick Version mode systems running in a North American locale. They are not supported in IP Office Standard mode.

Both 'Refresh' and 'Euro Style' variants of the phones are supported. An additional analog device using the same extension number can be connected via the ETR phone's AUX socket.

A maximum of 4 ETR 34D phones are supported on a system with a maximum of 2 on any individual ETR6 base card.



8.7.14 M7100

Avaya M and T-Series phones are supported by IP Office Release 7.0 and higher on an IP500v2. They can be connected to digital station ports provided by an IP500 TCM8 base card or on a DS16A/DS30A external expansion module.



8.7.15 M7100N

Avaya M and T-Series phones are supported by IP Office Release 7.0 and higher on an IP500v2. They can be connected to digital station ports provided by an IP500 TCM8 base card or on a DS16A/DS30A external expansion module.



8.7.16 M7208

Avaya M and T-Series phones are supported by IP Office Release 7.0 and higher on an IP500v2. They can be connected to digital station ports provided by an IP500 TCM8 base card or on a DS16A/DS30A external expansion module.



8.7.17 M7208N

Avaya M and T-Series phones are supported by IP Office Release 7.0 and higher on an IP500v2. They can be connected to digital station ports provided by an IP500 TCM8 base card or on a DS16A/DS30A external expansion module.



8.7.18 M7310

Avaya M and T-Series phones are supported by IP Office Release 7.0 and higher on an IP500v2. They can be connected to digital station ports provided by an IP500 TCM8 base card or on a DS16A/DS30A external expansion module.



8.7.19 M7310N

Avaya M and T-Series phones are supported by IP Office Release 7.0 and higher on an IP500v2. They can be connected to digital station ports provided by an IP500 TCM8 base card or on a DS16A/DS30A external expansion module.



8.7.20 M7324

Avaya M and T-Series phones are supported by IP Office Release 7.0 and higher on an IP500v2. They can be connected to digital station ports provided by an IP500 TCM8 base card or on a DS16A/DS30A external expansion module.

- Additional buttons can be supported on a M7324 phone through the addition of [KLM button module](#) ⁽¹⁸⁵⁾.



8.7.21 M7324N

Avaya M and T-Series phones are supported by IP Office Release 7.0 and higher on an IP500v2. They can be connected to digital station ports provided by an IP500 TCM8 base card or on a DS16A/DS30A external expansion module.



8.7.22 T7000

Avaya M and T-Series phones are supported by IP Office Release 7.0 and higher on an IP500v2. They can be connected to digital station ports provided by an IP500 TCM8 base card or on a DS16A/DS30A external expansion module.

The T7000 telephone is an entry-level digital set for basic low-use office environments. The T7000 is used primarily in the EMEA (not available in North America).



8.7.23 T7100

Avaya M and T-Series phones are supported by IP Office Release 7.0 and higher on an IP500v2. They can be connected to digital station ports provided by an IP500 TCM8 base card or on a DS16A/DS30A external expansion module.



8.7.24 T7208

Avaya M and T-Series phones are supported by IP Office Release 7.0 and higher on an IP500v2. They can be connected to digital station ports provided by an IP500 TCM8 base card or on a DS16A/DS30A external expansion module.



8.7.25 T7316

Avaya M and T-Series phones are supported by IP Office Release 7.0 and higher on an IP500v2. They can be connected to digital station ports provided by an IP500 TCM8 base card or on a DS16A/DS30A external expansion module.



8.7.26 T7316E

Avaya M and T-Series phones are supported by IP Office Release 7.0 and higher on an IP500v2. They can be connected to digital station ports provided by an IP500 TCM8 base card or on a DS16A/DS30A external expansion module.

- Additional buttons can be supported on a T7316E phone through the addition of [T7316E KEM](#) button modules.



8.7.27 T7406, T7406e

Avaya M and T-Series phones are supported by IP Office Release 7.0 and higher on an IP500v2. They can be connected to digital station ports provided by an IP500 TCM8 base card or on a DS16A/DS30A external expansion module.

These cordless phones use a base station that can support multiple sets. The T7406E base station supports up to 4 T7406E handsets. The T7406 base station supports up to 3 T7406 handsets. Each supported handset requires a connection from the base station to a TCM port on the IP Office system.

Each phone is dedicated to its base station and cannot roam even if multiple base stations are installed.

The T7406E is available in North America, Mexico and Caribbean countries excluding Jamaica and Trinidad. The T7406E replaces the discontinued T7406 cordless telephone.



8.8 Phone Add-Ons

For IP Office Release 5.0 and higher, the maximum combined number of buttons on buttons modules per system is 1024. T3 DSS modules are not included in the combined limits stated above but are limited to 30 T3 DSS modules (1080 buttons).

- **BM12**: *+24 (Max 3 per phone, 32 per system.)*
Add-on for 9408 and [9508](#) phones. Provides 12 buttons assignable in 2 pages for 24 features.
- **DBM32**: *+32 (Max 3 per phone, 32 per system.)*
Add-on for the 1416 phones that provides two columns of 16 buttons. Up to 3 BM32 modules are supported with any 4616. For IP Office 5.0, up to a maximum of 32 BM32 modules total are supported the IP Office system.
- **KLM**: *+48 (Max 2 per phone, 21 per system.)*
Used with [M7324](#) phones. Up to 2 buttons modules are supported per phone. Each button module provides 48 programmable buttons.
- **T7316E KEM**: *+24 (Max 9 per phone, 42 per system.)*
Used with [T7316E](#) phones. Each button module provides 24 programmable buttons.

8.8.1 DBM32

The DBM32 add on provides an additional 32 twin-LED programmable buttons for 1416 phones. The units do not require their own power supply connection as they draw power from the phone to which they are connected.

- Up to 3 units can be connected in a chain from a single 1416.
- Up to a maximum of 32 DBM32 units on the system.

Item	SAP Code
DBM32 BUTTON MODULE	700469968
Accessories	
1600 SERIES BM32 CABLE - REPLACEMENT	700415581
1600 SERIES BM32 BOND BRIDGE - REPLACEMENT	700415599
1616/BM32 PLASTIC LABEL COVERS (20) – REPLACEMENT	700415672
1600 SERIES BM32 FLIP STAND - REPLACEMENT	700432800
Paper Labels	
1616/BM32 PAPER DESI LABELS - PACKAGE OF 50 LABELS (8.5" x 11")	700415656
1616/BM32 PAPER DESI LABELS - PACKAGE OF 50 LABELS (A4)	700434236

-  Note for Australian installations only:
Installations of the 1416 terminal with an 1151 PSU and DBM32 must be restricted to the same building as the host Gateway. That is, the 1416 – if installed with an 1151 PSU and DBM32 – cannot be connected in a campus environment where the 1416 terminal is installed in a building separate from the building housing the Gateway. This application cannot be used with exposed (out-of-building) wiring.
 - For installations in which the 1416 is used without the 1151 PSU and DBM32, campus connections are acceptable: the 1416 can be located in a separate building in these cases.
 - This restriction applies to Australian installations only.

8.8.2 KLM Module

This type of button module can be used with the [M7324](#)^[177] phones to provide additional programmable buttons. For IP Office Essential Edition - Quick Version, only 1 module can be attached to each phone. Each module requires its own power supply unit.

+01	+13	+25	+37
+02	+14	+26	+38
+03	+15	+27	+39
+04	+16	+28	+40
+05	+17	+29	+41
+06	+18	+30	+42
+07	+19	+31	+43
+08	+20	+32	+44
+09	+21	+33	+45
+10	+22	+34	+46
+11	+23	+35	+47
+12	+24	+36	+48

8.8.3 T7316e KEM

This type of button module can be used with the [T7316E](#) ^{18h} phones to provide 24 additional programmable buttons. In IP Office Essential Edition - Quick Version, up to 4 modules can be added, allowing a total of 72 programmable buttons.



+01	+13
+02	+14
+03	+15
+04	+16
+05	+17
+06	+18
+07	+19
+08	+20
+09	+21
+10	+22
+11	+23
+12	+24

8.9 Ancillary Systems

8.9.1 Digital Mobility Solution

Avaya 4100 Series and 7400 Series phones are supported using a Digital Mobility Solution (DMS). This is a DECT system that can be used to support up to 64 handsets. The DMS connects to the IP500 system using a TCM port for each handset.

Digital Mobility 2.4 GHz solution - North America and CALA		
7420 Handset		N7B80BK
7430 Handset		N7B80BLE6
7440 Handset		N7B80BOE6
Digital Mobility Base Station 10	2.4GHz, Compatible with Handset 7430/7440, Repeater 40.	N7B65KPE5
Digital Mobility Repeater 40	2.4GHz, Compatible with Handset 7430/7440, Base station 10.	N7B80AGE5
Digital Mobility External Antenna 51	International.	N7B65KWE5
DMC 080 Digital Mobility Controller	North America.	N7B65KJE5
DMC 320 Digital Mobility Controller	North America.	N7B65KKE5
Digital Mobility 1.9 GHz solution - North America		
7439 Handset	Replaces the 7430 model.	N7B80CLE6
7449 Handset	Replaces the 7430 model.	N7B80CNE6
Digital Mobility Base Station 19	North America.	N7B80CRE6
Digital Mobility Repeater 49	Canada, US.	N7B80CUE6
Digital Mobility External Antenna 51	International.	N7B65KWE5
DMC 080 Digital Mobility Controller	North America.	N7B65KJE5
DMC 320 Digital Mobility Controller	North America.	N7B65KKE5
Digital Mobility 1.8 GHz solution - Europe, Hong Kong, Australia, New Zealand		
4135 Handset	Europe & Hong Kong	N7B80BME6
4145 Handset	Europe & Hong Kong	N7B80BRE6
4145EX Handset KIT - EU	Ruggedized version of 4145 - Europe & Hong Kong	N7B80BWE6
4136 Handset	Australia/New Zealand	N7B80CCE6
4146 Handset	Australia/New Zealand	N7B80CEE6
4146EX Handset	Ruggedized version of 4146 - Australia/New Zealand	N7B80CFE6
Digital Mobility Base Station 15		N7B65KTE5
Digital Mobility Repeater 25		N7B65KUE5
Digital Mobility Repeater 45		N7B80AHE5
Digital Mobility External Antenna 51	International	N7B65KWE5
DMC 081 Digital Mobility Controller	International	N7B80AAE5
DMC 321 Digital Mobility Controller	International	N7B80ABE5
Digital Mobility 1.8 GHz solution - South America		
7434 (South America)		N7B80ACE6
7444 (South America)		N7B80ADE6
Digital Mobility Base Station 14		N7B80AEE6
Digital Mobility Repeater 24		N7B80AFE6
Digital Mobility External Antenna 51	International	N7B65KWE5
DMC 081 Digital Mobility Controller	International	N7B80AAE5
DMC 321 Digital Mobility Controller	International	N7B80ABE5

8.10 Applications

This section outlines the requirements for various IP Office applications. These are just outlines, for full details refer to the specific installation manuals for those applications and to the IP Office Technical Bulletins.

8.10.1 Manager

This tool is used to access all parts of the IP Office configuration. Different levels of access can be defined to control which parts of the configuration the Manager user can view and alter. Manager is also used to upgrade the software files used by an IP Office system. When running is also acts as a TFTP server from which some Avaya phones can request new software.

Note that IP Office Manager's software level is always two higher than the IP Office core software with which it is release. For example IP Office 6.0 core software is release with IP Office Manager 8.0.

IP Office Manager is backwards compatible and can be used to manage IP Office systems running software from IP Office 2.1 upwards.

Details	
DVD	IP Office Release 7.0 User/Admin DVD Set (2) (700500928) (Disk 1)
Languages	English, Brazilian, Dutch, French, German, Italian, Spanish (Mexican).
License	X No license required.

PC Requirements

Minimum PC Requirements	
RAM	256MB
Hard Disk Free Space	1GB*
Processor:	
- Pentium	PIII 800MHz
- Celeron	Celeron 3 800Mhz
- AMD	Athlon Opteron, Athlon64/XP
Additional Apps:	
- .NET2	Installed with Manager if not already present.

Operating System Support	
Server OS:	
2003 Server	✓
2008 Server	✓
Client OS:	
XP Professional	✓
Vista	✓
Windows 7	✓

- Vista support is only on Business, Enterprise and Ultimate versions.
- Windows 7 support is only on Professional, Enterprise and Ultimate versions.

*Includes disk space required for .NET2 component.

Ports

Component	Location - %ProgramFiles%\Avaya\IP Office\	Ports
IP Office Manager	Manager\manager.exe	TCP Port 50802. TCP Port 50804. TCP Port 50812. UDP Port 50798.

8.10.2 Monitor

Monitor (also known as System Monitor) is a tool that can show all activity on the IP Office system in great detail. As a consequence, interpretation of Monitor traces requires a high-level of data and telephony protocol knowledge. However, all IP Office installers and maintainers must understand how to run Monitor when necessary as Avaya may request copies of Monitor traces to resolve support issues.

For IP Office 4.0 and higher, the [System Status Application](#)^[190] has been added to provide more easily interpreted information than is provided by Monitor.

- Two versions of Monitor are included in the IP Office Admin applications suite, one for IP Office 4.0 systems and one for pre-4.0 IP Office systems. Care should be taken to ensure that the correct version is used when monitoring an IP Office system.

Details	
DVD	IP Office Release 7.0 User/Admin DVD Set (2) (700500928) (Disk 1)
Languages	English only.
License	✘ No license required.

PC Requirements

Minimum PC Requirements	
RAM	128MB
Hard Disk Free Space	10GB
Processor:	
- Pentium	PIII 800MHz
- Celeron	Celeron 3 800Mhz
- AMD	Athlon B 650MHz

Operating System Support	
Server OS:	
2003 Server	✓
2008 Server	✓
Client OS:	
XP Professional	✓
Vista	✓
Windows 7	✓

- Vista support is only on Business, Enterprise and Ultimate versions.
- Windows 7 support is only on Professional, Enterprise and Ultimate versions.

Ports

Component	Location - %ProgramFiles%\Avaya\IP Office\	Ports
System Monitor	Monitor\sysmonitor.exe	UDP 50794.

8.10.3 System Status Application (SSA)

This tool provides a wide range of information about the current status of an IP Office 4.0 or higher system. Its includes available resources and components within the system. This includes details of current call in progress. Details of the number of alarms are recorded and the time date of the most recent alarms.

When required for diagnostics escalation SSA is able to take a snap shot image of the IP Office system's status including a copy of its current configuration. Use of SSA requires an IP Office service user name and password that has been configured for System Status access in the IP Office's security settings.

- For IP500v2 systems, SSA is pre-installed on the system's Avaya SD memory card and can be run by browsing to the IP Office system's IP address.

Details	
DVD	IP Office Release 7.0 User/Admin DVD Set (2) (700500928) (Disk 1)
License	X No license required.

PC Requirements

Minimum PC Requirements	
RAM	256MB
Hard Disk Free Space	1.4GB
Processor:	
- Pentium	PIII 800MHz
- Celeron	Celeron 3 800Mhz
- AMD	Athlon B 650MHz
Additional Apps:	
- Sun Java Virtual Machine	Installed with SSA if not already present.
- Web Browser	<ul style="list-style-type: none"> • Internet Explorer 7+. • Mozilla Firefox 3.0.

Operating System Support	
Server OS:	
2003 Server	✓
2008 Server	✓
Client OS:	
XP Professional	✓
Vista	✓
Windows 7	✓

- Vista support is only on Business, Enterprise and Ultimate versions.
- Windows 7 support is only on Professional, Enterprise and Ultimate versions.

8.10.4 TAPI

IP Office TAPI is a client PC application that allows TAPI compliant applications to interact with the IP Office.

- 1st Party TAPI

In this unlicensed mode the TAPI software supports control of an individual user's associated extension, allowing a TAPI compliant application to answer (requires a phone that supports handsfree answer) and make calls.

Details	
DVD	IP Office Release 7.0 User/Admin DVD Set (2) (700500928) (Disk 1)
License	✗

PC Requirements: 1st Party TAPI

Minimum PC Requirements	
RAM	64MB
Hard Disk Free Space	50MB
Processor:	
- Pentium	PIII 800MHz
- Celeron	Celeron 3 800Mhz
- AMD	Athlon B 65-0MHz

Operating System Support	
Server OS:	
2003 Server	✗
2008 Server	✗
Client OS:	
XP Professional	✓
Vista	✓
Windows 7	✓

- Vista support is only on Business, Enterprise and Ultimate versions.
- Windows 7 support is only on Professional, Enterprise and Ultimate versions.

PC Requirements: 3rd Party TAPI

Minimum PC Requirements	
RAM	64MB
Hard Disk Free Space	50MB
Processor:	
- Pentium	PIII 800MHz
- Celeron	Celeron 3 800Mhz
- AMD	Athlon B 65-0MHz

Operating System Support	
Server OS:	
2003 Server	✓
2008 Server	✓
Client OS:	
XP Professional	✓
Vista	✓
Windows 7	✓

Ports

Component	Location - %ProgramFiles%\Avaya\IP Office\	Ports
TAPI2	TAPI\tspi2w.tsp	UDP 50797.

8.10.5 IP Office Ports

Most PC firewalls will request the user to allow various exceptions when a newly installed application is first run. However this may not always be the case, especially if the firewall is located elsewhere than the user's PC.

Adding Firewall Exceptions

The file `avayafw.bat` can be used to open up the necessary firewall exceptions for IP Office applications. The file can be downloaded from <http://marketingtools.avaya.com/knowledgebase/tools/firewall>.

It only works for:

- The default Windows XP/Windows 2003 firewall.
- The application must be installed for the exception to be created.
- The application must be installed in the default location.

Whilst `avayafw.bat` only works subject to the conditions above, for other firewalls study of this file will indicate the necessary application files and ports for which exceptions need to be created.

Ports Used

The list below details many of the IP ports used by IP Office control units and IP Office applications. Many of these are standard ports for different IP traffic protocols.

◀ Indicates a listening port on the IP Office control unit. ▶ indicates a port to which the IP Office sends, for example to a PC running an IP Office application.

* Indicates that the port and or protocol can be changed.

Port		Protocol	Function
25*	▶	SMTP TCP	Email system alarms from the IP Office to SMTP server. For IP Office 4.2 also used for Voicemail Email on Embedded Voicemail.
37	▶	Time UDP	Time requests from the IP Office to a Time Server (RFC868).
53	◀	DNS UDP	Domain Name Service responses.
67	◀	BOOTP/DHCP UDP	DHCP server operation.
68	▶	BOOTP/DHCP UDP	DHCP client operation.
69	◀	TFTP UDP	File requests to the IP Office.
69	▶	TFTP UDP	File requests by the IP Office.
80	◀	HTTP TCP	HTTP File requests.
161*	◀	SNMP UDP	From SNMP applications.
162*	▶	SNMP Trap UDP	To addresses set in the IP Office configuration.
500	◀	IKE UDP	Key exchange for IPSec protocol.
389*	▶	LDAP TCP	Lightweight Directory Access Protocol.
443		HTTPS TCP	HTTPS communication with IP Office provisioned DECT, IP Office Softphone.
520	▶	RIP UDP	To and from the IP Office to other RIP devices. For RIP1 and RIP2 (RIP1 compatible) the destination address is a subnet broadcast, eg. 192.168.42.255. For RIP2 Multicast the destination address is 224.0.0.9.
520	◀	RIP UDP	
1701	◀	L2TP UDP	Layer 2 tunneling protocol.
1718	◀	H.323 UDP	H.323 Discovery
1719	◀	H.323 RAS UDP	H.323 Status. VoIP device registering with the IP Office.
1720	▶	H.323/H.245 UDP	H.323 Signalling. Data to a registered VoIP device.
2127	▶	(UDP) UDP	PC Wallboard to CCC Wallboard Server.
3478	▶	SIP UDP	Port used for STUN requests from the IP Office to the SIP provider.
5005	◀	RTCPMon UDP	RTCP Monitoring information from Avaya H323 phones.
5060	◀▶	SIP UDP/ TCP*	SIP Line Signalling
8080	▶	HTTP TCP	Browser access to the Delta Server application.
8089	▶	Enconf UDP	From the IP Office to the Conferencing Center Server Service. User access to the Conferencing Center is direct via HTTP sessions.
8888	▶	HTTP TCP	Browser access to the IP Office ContactStore (VRL) application.

Port		Protocol		Function
49152 to 53247 *	◀▶	RTP/RTCP	UDP	Dynamically allocated ports used during VoIP calls for RTP and RTCP traffic. The port range can be adjusted through the System Gatekeeper tab.
50791	▶	IPO Voicemail	UDP	To voicemail server address.
50793	◀	IPO Solo Voicemail	UDP	From IP Office TAPI PC with Wave drive user support.
50794	◀	IPO Monitor	UDP	From the IP Office Monitor application.
50795	◀	IPO Voice Networking	UDP	Small Community Network signalling (AVRIP) and BLF updates. Each system does a broadcast every 30 seconds. BLF updates are sent required up a maximum of every 0.5 seconds.
50796	◀	IPO PCPartner	UDP	From an IP Office application (for example Phone Manager or SoftConsole). Used to initiate a session between the IP Office and the application.
50797	◀	IPO TAPI	UDP	From an IP Office TAPI user PC.
50798	▶	(UDP)	UDP	<i>BT Fusion variant. No longer used.</i>
50799	▶	IPO BLF	UDP	Broadcast to the IP Office LAN and the first 10 IP addresses registered from other subnets.
50800	▶	IPO License Dongle	UDP	To the License Server IP Address set in the IP Office configuration.
50801	◀	EConf	UDP	Conferencing Center Service to IP Office.
50802	◀	Discovery	TCP	IP Office discovery from Manager.
50804 *	◀	Service Access Protocol	TCP	IP Office configuration settings access.
50805 *	◀		TCP	" TLS Secure.
50808 *	◀		TCP	IP Office system status access.
50812 *	◀		TCP	IP Office security settings access.
50813 *	◀		TCP	" TLS Secure.

- CDR/SMDR from the IP Office is sent to the port number and IP address defined during configuration and using either TCP or UDP as selected.

Ports

IP Office Monitor can be used to display IP packet details including the source and destination Port numbers. As well as displaying the port numbers (in decimal), IP Office Monitor also displays the names of more commonly used ports including IP Office specific ports.

For example "src = 23" is interpreted as "src = 23 (Telnet)".

The list below details the ports currently decoded by IP Office Monitor. For a full list of assigned non-IP Office ports see <http://www.iana.org/assignments/port-numbers>.

- 20 File Transfer [Default Data]
- 21 File Transfer [Control]
- 23 Telnet
- 25 Simple Mail Transfer
- 37 Time
- 43 Who Is
- 53 Domain Name Server
- 67 Bootstrap Protocol Server
- 68 Bootstrap Protocol Client
- 69 Trivial File Transfer
- 70 Gopher
- 79 Finger
- 80 World Wide Web-HTTP
- 115 Simple File Transfer Protocol
- 123 Network Time Protocol
- 137 NETBIOS Name Service
- 138 NETBIOS Datagram Service
- 139 NETBIOS Session Service
- 156 SQL Service
- 161 SNMP
- 162 SNMPTRAP
- 179 Border Gateway Protocol
- 1719 H.323Ras
- 1720 H.323/H.245
- 50791 IPO Voicemail
- 50792 IPO Network DTE
- 50793 IPO Solo Voicemail (i.e. Wave driver for TAPI)
- 50794 IPO Monitor
- 50795 IPO Voice Networking
- 50796 IPO PCPartner
- 50797 IPO TAPI
- 50798 IPO Who-Is response
- 50799 IPO BLF
- 50800 IPO License Dongle
- 50801 EConf

Protocols

IP Office Monitor, as well as displaying the Protocol number (in decimal) of packets, also displays the names of the more common Protocols. For example "pcol = 1" is decoded as "pcol = 1 (ICMP)".

Protocol numbers currently decoded by IP Office Monitor are:

- 1 - Internet Control Message [ICMP]
- 2 - Internet Group Management [IGMP]
- 6 - Transmission Control [TCP]
- 8 - Exterior Gateway Protocol [EGP]
- 9 - Interior Gateway Protocol [IGP]
- 17 - User Datagram [UDP]
- 41 - Ipv6 [IPV6]
- 46 - Reservation Protocol [RSVP]
- 47 - General Routing Encapsulation [GRE]
- 58 - ICMP for IPv6 [IPv6-ICMP]
- 111 - IPX in IP[IPX-In-IP]
- 115 - Layer Two Tunneling Protocol [L2TP]
- 121 - Simple Message Protocol [SMP]

8.11 Physical Ports

The following port types are found on IP Office systems:

- [ANALOG](#) ⁽¹⁹⁸⁾
Used for the connection of external analog trunks.
- [AUDIO](#) ⁽¹⁹⁸⁾
Used for input of an external music on hold source.
- [BRI](#) ⁽¹⁹⁹⁾
Used for connection of BRI trunks (Quad BRI trunk card).
- [DC I/P](#) ⁽²⁰⁰⁾
Power input from external power supply unit.
- [DS](#) ⁽²⁰⁰⁾
Connection of Avaya digital station phones supported by IP Office.
- [RS232/DTE](#) ⁽¹⁰⁷⁾
Used for control unit maintenance under Avaya guidance. On expansion modules not used.
- [EF](#) ⁽²⁰¹⁾
Emergency power failure ports found on the ETR6 base card.
- [ETR](#) ⁽²⁰²⁾
Only supported on IP500v2 control unit running in IP Office Essential Edition - PARTNER® Version or IP Office Essential Edition - Quick Version modes.
- [EXPANSION](#) ⁽²⁰³⁾
Used for interconnection of external expansions modules and control units.
- [EXT O/P](#) ⁽¹⁰⁸⁾
Used to control external relay systems. The port provides two switchable (on, off and pulse) controls.
- 
Used for connection of functional or protective ground if required.
- [LAN](#) ⁽²⁰⁴⁾
10/100Mbps Ethernet LAN ports.
- [PF](#) ⁽²⁰⁵⁾
Analog power fails ports.
- [PHONE](#) ⁽²⁰⁶⁾ ([POT](#)) ⁽²⁰⁶⁾
Analog phone extension ports. On older units these ports are labeled as POT ports.
- [PRI](#) ⁽²⁰⁷⁾
PRI trunk ports.
- [TCM](#) ⁽²⁰⁸⁾
Connection for M-Series and T-Series phones supported by IP Office. Also for Digital Mobility Solution system supporting 4100 Series and 7400 Series phones.
- USB
Not used.

8.11.1 Cables

The IP Office systems are designed primarily for use within an RJ45 structured cabling system using CAT3 unshielded twisted-pair (UTP) cabling and RJ45 sockets.

A structured cabling system is one where cables are run from a central RJ45 patch panel in the communications/data room to individual RJ45 sockets at user locations. All wires in each cable between the patch panel and the desk socket are connected straight through. This arrangement allows devices connected at the patch panel to be swapped to match the type of device that needs to be connected at the user socket. For example, making one user socket a phone port and another user socket a computer LAN port, without requiring any rewiring of the cables between the patch panel and the user location.

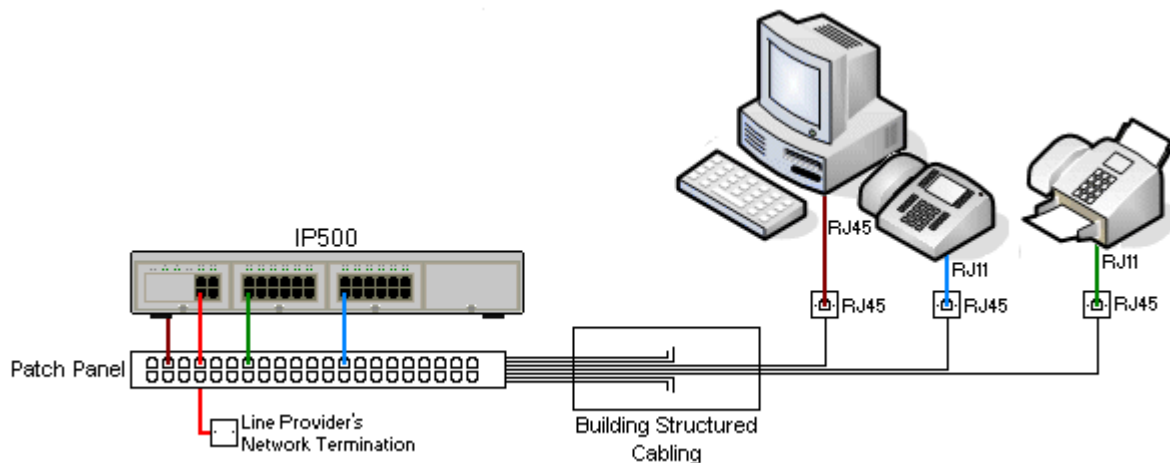

- **Traditional IDC Punchdown Wiring Installations**
Where necessary, the far end RJ45 plug can be stripped from IP Office cables and wired into traditional wiring systems using punch-block connectors. This type of installation should be performed by an experienced wiring technician.
- **Trunk Connections**
The majority of IP Office trunk ports use RJ45 connectors for acceptance of an RJ45-to-RJ45 cable. However, connection at the line provider's end may require use of a different plug type in order to match the line providers equipment.
- **RJ11 Phone Connectors**
Many phones use RJ11 sockets and are supplied with RJ11-to-RJ11 cables. RJ11 plugs can be inserted into RJ45 sockets and in many case the connection will work. However this is not recommended or supported as the connection lock is not truly positive and may become disconnected. An [RJ45-to-RJ11 cable](#)^[200] is available for these connections.

Standard IP Office Cables

The following are Avaya standard cables available for use with IP Office systems. The maximum length is applicable if the standard Avaya cable is replaced with an alternate cable.

Cable	Description	SAP Code	Standard Length	Maximum Length
9-Way DTE Cable ⁽¹⁰⁷⁾	Connects to control unit RS232 DTE port. 9-Way D-type plug to 9-way D-type socket.	–	2m/6'6".	2m/6'6".
Structured Cabling DS Line Cable ⁽²⁰⁶⁾	Connects from RJ45 sockets to RJ11 socketed DS and analog phones.	TT700047871	4m/13'2".	See table below.
BRI/PRI Trunk Cable ⁽¹⁹⁹⁾	Connects BRI/PRI trunk ports to the line provider's network termination point. RJ45 to RJ45. Red.	700213440	3m/9'10".	–
Expansion Interconnect Cable ⁽²⁰³⁾	Connects the control unit to expansion modules. RJ45 to RJ45. Blue.	700213457	1m/3'3".	1m/3'3".
LAN Cable ⁽²⁰⁴⁾	Connects from IP Office LAN ports to IP devices. RJ45 to RJ45. Grey.	700213481	3m/9'10".	100m/328'.



The table below details the maximum total cable distances for DS and analog extensions using different cable types.

Telephone	Unshielded Twisted-Pair (UTP) - 50nf/Km			CW1308
	AWG22 (0.65mm)	AWG24 (0.5mm)	AWG26 (0.4mm)	
1400 Series	1200m/3937'.	1000m/3280'.	670m/2200'.	400m/1310'.
9400/9500 Series	1200m/3937'.	1000m/3280'.	670m/2200'.	400m/1310'.
TCM (without power booster)	–	305m/1000'	–	–
" (with power booster)	–	790m/2600'	–	–
Analog Phones	1000m/3280'.	1000m/ 3280'.	400m/1640'.	800m/2620'.
ETR Phones	305m/1000'.	305m/1000'.	122m/400'.	122m/400'.

8.11.2 ANALOG Port

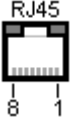
These ports are analog trunk ports. The IP400 ATM4 analog trunk cards and IP500 analog trunk cards only support loop-start trunks. The ATM16 Analog Trunk module supports both loop-start and ground-start trunks, switchable within the IP Office configuration.

ANALOG	Pin	Description
 An RJ45 port diagram showing a rectangular connector with eight pins. The pins are numbered 1 through 8. Pin 1 is on the right side, and pin 8 is on the left side. The label 'RJ45' is positioned above the connector.	1	Not used.
	2	Not used.
	3	Not used.
	4	Ring.
	5	Tip.
	6	Not used.
	7	Not used.
	8	Not used.

- Off-Hook Current: 25mA.
-  **IMPORTANT**
In all IP Office installations, any module being used for analog trunk connections must be connected to a [functional earth](#) ^[25].
-  **WARNING**
Within the Republic of South Africa and in areas of high lightning risk, any module using analog trunk connections must be connected to a [protective ground](#) ^[25] and to [surge protection equipment](#) ^[26].

8.11.3 AUDIO Port

This port is found on the rear of all IP Office control units. It is used for the input of an external music-on-hold sound source. Note that if the IP Office has loaded an internal music-on-hold sound file, any input from this socket is ignored.

The port is a 3.5mm stereo jack socket suitable for use with the most standard audio leads and connection to the 'headphone' output socket of most audio systems.

The use of a 'headphone' socket allows simple volume adjustment. Connection via a 'Line Out' socket may require additional equipment in order to adjust the volume level.

Pin No.	Description
Common	● Common
Left	← Audio In - Left Channel.
Right	← Audio In - Right - Channel.

- Input impedance: 10k /channel. Maximum a.c. signal – 200mV rms.

8.11.4 BRI Port (To)

These ports are BRI To interface ports for connection to external BRI trunk services. Note that BRI ports found on the IP400 So8 module are BRI-S interface ports for connect to ISDN terminal devices, see BRI Port (So).

PRI/BRI Trunk Cable

This cable is used to connect from IP Office BRI/PRI trunk ports to the line providers network termination equipment. If that equipment does not use RJ45 sockets, the cable may need to be stripped and rewired or an alternate cable used. The appropriate signal pin-outs and wire colours are detailed below.

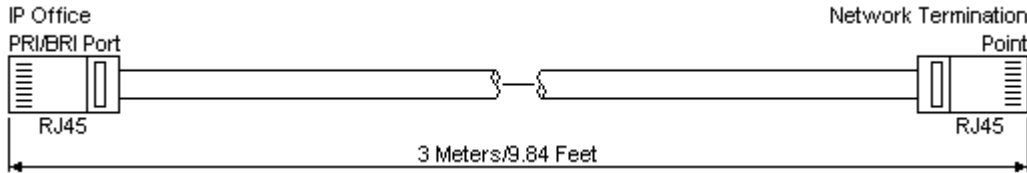

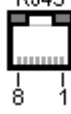
IP Office				Wire	Network Termination	
BRI	RJ45	BRI	PRI		PIN	RJ45
	1	–	← Rx-A	White/Orange	1	
	2	–	← Rx-B	Orange/White	2	
	3	→ Tx-A	–	White/Green	3	
	4	← Rx-A	→ Tx-A	Blue/White	4	
	5	← Rx-B	→ Tx-B	White/Blue	5	
	6	→ Tx-B	–	Green/White	6	
	7	–	–	White/Brown	7	
	8	–	–	Brown/White	8	

- Supply: BRI/PRI trunks cards are not supplied with these cables.
- Cable Color: Red.
- SAP Code: 700213440.
- Standard Length: 3m/9'10".
- Maximum Length: 5m/16'5".
- Though not used pins 7 and 8 are through connected for ease of construction.

8.11.5 DC I/P Port

Found on all IP Office control units and expansion modules. Used for connection from the external [power supply unit](#)^[20] supplied with the control unit or module.

- No other type of power supply unit should be used with the module or module unless specifically indicated by Avaya.
- Power cords must not be attached to the building surface or run through walls, ceilings, floors and similar openings.

8.11.6 DS Ports

These ports are used for connection from an RJ45 structured cabling system to digital station phones supported by the IP Office. DS ports are provided by [IP500 Digital Station Cards](#)^[142], [IP500 ATM Combination Cards](#)^[146], [IP500 BRI Combination Cards](#)^[141] and [IP500 Digital Station](#)^[152] external expansion modules.

Though the RJ11 to RJ11 cables supplied with some phones can be plugged directly into RJ45 ports including those on IP Office modules, this is not recommend as the connection lock is not positive and may become disconnected.

DS ports on Digital Station V1/V2 expansion modules can be connected to [out-of-building extensions](#)^[26]. If this is the case, connection must be made via suitable protective devices at each end and via each building primary protection. In addition the Digital Station module must be connected to a protective ground.



DS ports on IP Office control units must not be connected to out-of-building extensions.

Structured Cabling Line Cord

This is an RJ45 to RJ11 cable suitable for connection from a structured cabling system RJ45 port to a DS phone. It can also be used for two-wire analog phone extensions.

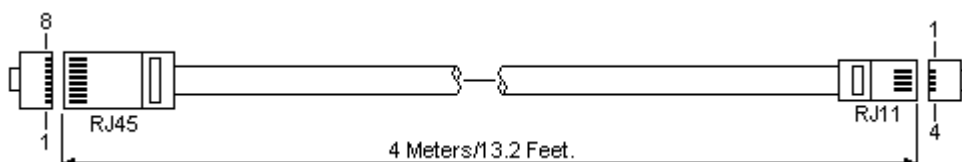
This cable is not suitable for connection from an Avaya 1151D1/B2 power supply unit to a DS phone with a 4450, EU24 or XM24 add-on module. In those cases the cables supplied with the power supply unit and the add-on module should be used.

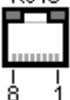

IP Office		Phone		
DS Port	Pin	Description	Pin	Port
	1	Not used.	–	
	2	Not used.	1	
	3	Not used.	2	
	4	Signal 1.	3	
	5	Signal 2.	4	
	6	Not used.	5	
	7	Not used.	6	
	8	Not used.	–	

- SAP Code: T700047871.

8.11.7 EF Port

These ports are found on the ETR6 base card. They are analog trunk ports that are only useable when the card is fitted with an IP500 ATM4 trunk daughter card. When in power fail, the EF ports are connected to trunk port 12.

8.11.8 RS232 DTE Port

These ports are found on the rear of all IP Office control units and external expansion modules. The DTE ports on external expansion modules are not used.

The RS232 DTE ports on the control units can be used for system maintenance and connection of serial terminal adaptors. On IP400 control units the port can also be used for connection of the IP Office serial port licence key dongle.

An asynchronous terminal program such as HyperTerminal is also required. Configure this for operation via a PC serial port, as follows:

Bits per second	38,400	Parity	None	Flow Control	None
Data bits	8	Stop Bits	1	Settings Emulation	TTY

DTE Cables

These cables are used for system maintenance and diagnostics under Avaya guidance. They can also be used for connection of RS232 serial terminal adaptor equipment to the IP Office control unit. The cable required depends on the IP Office control unit. This cable is a "Straight through DB9 female to DB9 male serial cable".

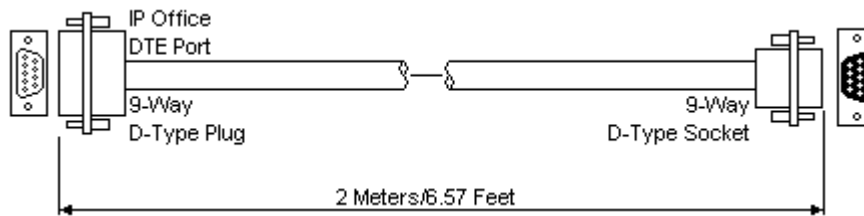

IP Office 9-Way RS232 DTE Port	Signal	PC/Terminal Adaptor
3	← Receive data	3
2	→ Transmit Data	2
7	← RTS (Request To Send)	7
8	→ CTS (Clear To Send)	8
6	→ DSR (Data Set Ready)	6
5	● Ground	5
1	→ DCD (Data Carrier Detect)	1
4	← DTR (Data Terminal Ready)	4
9	→ RI (Ring Indicator)	9

8.11.9 ETR Port

ETR (Enhanced Tip and Ring) ports are provided by the ETR6 base card. They can be used for the connection of DTMF analog phone devices and Avaya ETR phones.

8.11.10 EXPANSION Port

This type of port is found on the rear of IP Office control units and external expansion modules. It is used for connecting the external expansion modules to their parent IP Office control unit.

The connection between these ports should only be done using an Avaya Expansion Interconnect Cable. No other cable type should be used.

- Each external expansion module is supplied with a blue 1 meter (3'3") expansion interconnect cable. This cable must be used when connecting to expansion ports on the rear of a control unit.

Expansion Interconnect Cable

The Expansion Interconnect cable is used to link expansion ports between the IP Office control unit and external expansion modules.

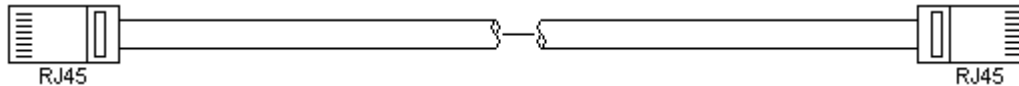

- Supply: One cable is normally supplied with each external expansion module.
- SAP Code: 1m (3'3") Blue cable - 700213457, 2m (6'6") Yellow cable - 700472871.

8.11.11 EXT O/P Port

These ports are found on the rear of all IP Office control units. They are used for connection to external switching relays. The port uses a standard 3.5mm stereo jack plug for connection.

The IP Office is able to open (high resistance), close (low resistance) or pulse (close for 5 seconds and then open) two switches within the port. Either switch can be operated separately. These switches are intended for activation of external relays in systems such as door opening systems.

- CAUTION:** In installations where this port is connected to a device external to the building, connection must be via a towerMAX SCL/8 Surge Protector and a protective ground connection must be provided on the IP Office control unit.

EXT O/P	Pin	Description
	1	Switch 1.
	2	Switch 2.
	3	0 Volts (Ground/Chassis)

- Switching Capacity: 0.7A.
- Maximum Voltage: 55V d.c.
- On state resistance: 0.7 ohms.
- Short circuit current: 1A.
- Reverse circuit current capacity: 1.4A.
- Ensure that pins 1 and 2 are always at a positive voltage with respect to pin 3.

3.5mm stereo audio jack plugs are frequently sold as pre-wired sealed modules. It may be necessary to use a multi-meter to determine the wiring connections from an available plug. Typically 3 (common to both relays) is the cable screen.

8.11.12 LAN Port

These ports are found on IP Office control units. They are used for connection to IP LANs and IP devices.

All IP Office LAN ports are 10/100Mbps auto-sensing. Operation varies as follows:

- IP Office 500 / IP500v2
The WAN port is not supported on systems running in IP Office Essential Edition - Quick Version mode.



The LEDs are used as follows:

- Green: On = connected, Flashing = Activity.
- Yellow: On = 100Mbps, Off = 10Mbps.

LAN Cables

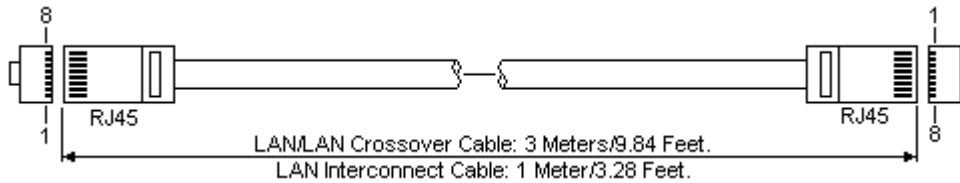
These are CAT5 UTP cables for connection of various IP devices within the IP Office system.

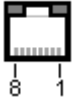

IP Office							
LAN	Pin	MDI X (Normal)	MDI (Crossover)	Wire	Standard/ Interconnect	Crossover	
	1	← Rx-A.	→ Tx-A.	White/Orange	1	3	
	2	← Rx-B.	→ Tx-B.	Orange/White	2	6	
	3	→ Tx-A.	← Rx-A.	White/Green	3	1	
	4	Not used.	Not used.	Blue/White	4	4	
	5	Not used.	Not used.	White/Blue	5	5	
	6	→ Tx-B.	← Rx-B.	Green/White	6	2	
	7	Not used.	Not used.	White/Brown	7	7	
	8	Not used.	Not used.	Brown/White	8	8	

- SAP Code:
 - LAN Cable - GREY: 700213481.
Standard straight LAN cable.
 - LAN Crossover Cable - Black: 700213473.
LAN crossover cable.

8.11.13 PF Port

These ports are found on the rear of the IP400 Analog Trunk expansion module. They are analog extension ports that can be used in conjunction with analog loop-start trunks during power failure to the IP Office system.

Any phones connected to these ports should be clearly labeled as power fail extensions in accordance with the appropriate national and local regulatory requirements.

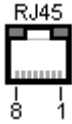
PF	Pin	Description
	1	Not used.
	2	Pin 2 is internally connected to pin 5 via a ringer capacitor.
	3	Not used.
	4	Ring.
	5	Tip.
	6	Pin 6 is internally connected to pin 5 via a ringer capacitor.
	7	Not used.
	8	Not used.

- Minimum Wire Size: AWG 26.
- Maximum Cable Length:
 - AWG26: 500m / 1640'.
 - AWG24, AWG22: 1000m / 3280'.

8.11.14 PHONE (POT) Port

These ports are analog extension ports. On older IP Office units these ports were labeled as POT ports rather than PHONE ports.

PHONE ports on Phone V1/V2 expansion modules can be connected to [out-of-building extensions](#)^[26]. If this is the case, connection must be made via suitable protective devices (IP Office Barrier Box) at each end and via each building primary protection. In addition the Phone module must be connected to a protective ground.

PHONE ports on IP Office control units must not be connected to out-of-building extensions.

PHONE	Pin	Description
	1	Not used.
	2	Not used.
	3	Not used.
	4	Ring.
	5	Tip.
	6	Not used.
	7	Not used.
	8	Not used.

- REN: 2
- Off-Hook Current: 25mA.
- Ring Voltage: 40V rms.
- Minimum Wire Size: AWG 26.
- Maximum Cable Length:
 - AWG26: 0.5km / 1640 feet.
 - AWG24, AWG22: 1km / 3280 feet.

Except on some older equipment, these ports do not include a ringing capacitor. Therefore for connection to 4-wire analog phones where this is a requirement (typically the United Kingdom and New Zealand), connection should be via a Master socket containing ringing capacitors. On some older IP403 control units and IP400 Phone V1 modules, pins 2 and 6 are internally connected via ringing capacitors.

Structured Cabling Line Cord

This is an RJ45 to RJ11 cable suitable for connection from a structured cabling system RJ45 port to a DS phone. It can also be used for two-wire analog phone extensions.

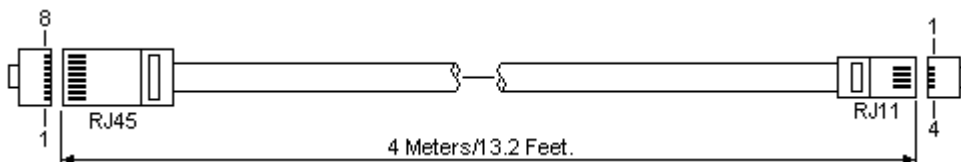

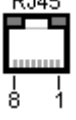
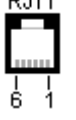
IP Office			Phone	
DS Port	Pin	Description	Pin	Port
	1	Not used.	–	
	2	Not used.	1	
	3	Not used.	2	
	4	Signal 1.	3	
	5	Signal 2.	4	
	6	Not used.	5	
	7	Not used.	6	
	8	Not used.	–	

- SAP Code: T700047871.

8.11.15 PRI Port

These ports are used for connection to PRI trunk services including E1, T1 and E1-R2.

PRI Trunk Cable

This cable is used to connect from IP Office PRI trunk ports to the line providers network termination equipment. If that equipment does not use RJ45 sockets, the cable may need to be stripped and rewired or an alternate cable used. The appropriate signal pin-outs and wire colours are detailed below.

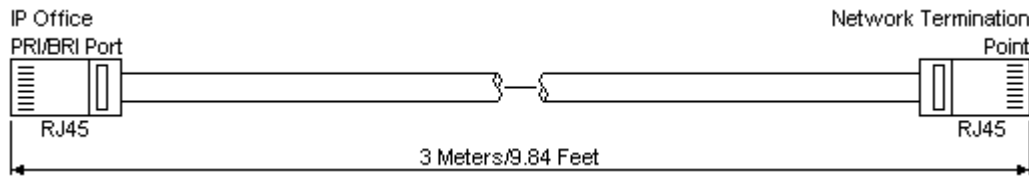

IP Office		Wire	Network Termination		
RJ45	PRI		PIN	RJ45	
	1	← Rx-A	White/Orange	1	
	2	← Rx-B	Orange/White	2	
	3	–	White/Green	3	
	4	→ Tx-A	Blue/White	4	
	5	→ Tx-B	White/Blue	5	
	6	–	Green/White	6	
	7	–	White/Brown	7	
	8	–	Brown/White	8	

- Supply: PRI trunks cards are not supplied with these cables.
- Cable Color: Red.
- SAP Code: 700213440.
- Standard Length: 3m/9'10".

8.11.16 TCM Port (RJ21)

These ports are used for TCM extension ports in an IP500v2 system. They are found on [IP500 Digital Station A](#)¹⁵⁴ external expansion modules. These are supported by IP500v2 systems running IP Office Release 7.0 and higher.

They are used for supported M-Series and T-Series digital stations. They are also used for 4100 and 7400 Series phone support by connection to a [Digital Mobility Solution](#)¹⁸⁷ system.

Cable lengths up to 305 m (1000 ft) using 0.5mm (24AWG) wires do not require a power booster. Lengths up to 790 m (2600 ft) are supported if an auxiliary power supply booster is used.

1st RJ21 Connector

Port		Pin	Wire
1	Tip	26	White/Blue
	Ring	1	Blue/White
2	Tip	27	White/Orange
	Ring	2	Orange/White
3	Tip	28	White/Green
	Ring	3	Green/White
4	Tip	29	White/Brown
	Ring	4	Brown/White
5	Tip	30	White/Slate
	Ring	5	Slate/White
6	Tip	31	Red/Blue
	Ring	6	Blue/Red
7	Tip	32	Red/Orange
	Ring	7	Orange/Red
8	Tip	33	Red/Green
	Ring	8	Green/Red
9	Tip	34	Red/Brown
	Ring	9	Brown/Red
10	Tip	35	Red/Slate
	Ring	10	Slate/Red
11	Tip	36	Black/Blue
	Ring	11	Blue/Black
12	Tip	37	Black/Orange
	Ring	12	Orange/Black
13	Tip	38	Black/Green
	Ring	13	Green/Black
14	Tip	39	Black/Brown
	Ring	14	Brown/Black
15	Tip	40	Black/Slate
	Ring	15	Slate/Black
16	Tip	41	Yellow/Blue
	Ring	16	Blue/Yellow
Not Used		42	Yellow/Orange
		17	Orange/Yellow
		43	Violet/Slate
		08	Slate/Violet

2nd RJ21 Connector

Port		Pin	Wire
1	Tip	26	White/Blue
	Ring	1	Blue/White
2	Tip	27	White/Orange
	Ring	2	Orange/White
3	Tip	28	White/Green
	Ring	3	Green/White
4	Tip	29	White/Brown
	Ring	4	Brown/White
5	Tip	30	White/Slate
	Ring	5	Slate/White
6	Tip	31	Red/Blue
	Ring	6	Blue/Red
7	Tip	32	Red/Orange
	Ring	7	Orange/Red
8	Tip	33	Red/Green
	Ring	8	Green/Red
9	Tip	34	Red/Brown
	Ring	9	Brown/Red
10	Tip	35	Red/Slate
	Ring	10	Slate/Red
11	Tip	36	Black/Blue
	Ring	11	Blue/Black
12	Tip	37	Black/Orange
	Ring	12	Orange/Black
13	Tip	38	Black/Green
	Ring	13	Green/Black
14	Tip	39	Black/Brown
	Ring	14	Brown/Black
Not Used		40	Black/Slate
		15	Slate/Black
		41	Yellow/Blue
		16	Blue/Yellow
		42	Yellow/Orange
		17	Orange/Yellow
	43	Violet/Slate	
	08	Slate/Violet	

8.11.17 TCM Port (RJ45)

These ports are used for TCM extension ports in an IP500v2 system. They are found on [IP500 TCM8 Digital Station Cards](#) [144]. These are supported by IP500v2 systems running IP Office Release 7.0 and higher.

They are used for supported M-Series and T-Series digital stations. They are also used for 4100 and 7400 Series phone support by connection to a [Digital Mobility Solution](#) [187] system.

Though the RJ11 to RJ11 cables supplied with some phones can be plugged directly into RJ45 ports including those on IP Office modules, this is not recommend as the connection lock is not positive and may become disconnected.

Cable lengths up to 305 m (1000 ft) using 0.5mm (24AWG) wires do not require a power booster. Lengths up to 790 m (2600 ft) are supported if an auxiliary power supply booster is used.

Structured Cabling Line Cord

This is an RJ45 to RJ11 cable suitable for connection from a structured cabling system RJ45 port to a TCM phone. It can also be used for two-wire analog phone extensions.

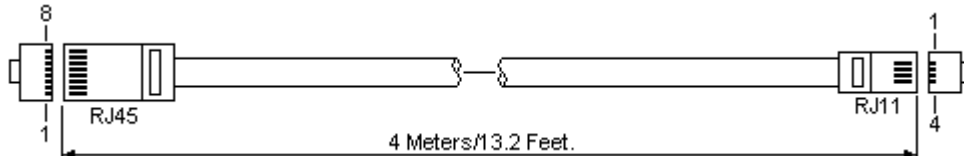

IP Office		Phone		
DS Port	Pin	Description	Pin	Port
	1	Not used.	–	
	2	Not used.	1	
	3	Not used.	2	
	4	Signal 1.	3	
	5	Signal 2.	4	
	6	Not used.	5	
	7	Not used.	6	
	8	Not used.	–	

- SAP Code: T700047871.

8.12 Licences

Various IP Office features and applications require entry of license keys into the system's configuration. The license keys are unique 32-character codes based on the feature being activated and the serial number of the [feature key dongle](#)^[159] installed with the IP Office system.

The serial number is printed on the feature key dongle and prefixed with FK. It can also be viewed in the system configuration using IP Office Manager.

- For IP500v2 systems, the feature key dongle takes the form of an SD card inserted into the control unit. The card is a mandatory item for these systems even if they use no licensed features.

When a license key is entered into the IP Office configuration, the following information is shown.

- **Status**
The status, which is Unknown until the configuration file is sent back to the IP Office system.
 - *Unknown*
This status is shown for licenses that have just been added to the configuration shown in IP Office Manager. Once the configuration has been sent back to the IP Office and then reloaded, the status will change to one of those below.
 - *Valid*
The features licensed can be configured and used.
 - *Invalid*
The license was not recognized. It did not match the serial number of the Feature Key.
 - *Dormant*
The license is valid but is conditional on some other pre-requisite licenses.
 - *Obsolete*
The license is valid but is one no longer used by the level of software running on the IP Office system.
 - *Expired*
The license has gone past its expiry date.
- **License**
The name of the licensed feature. This may differ from the ordered RFA name.
- **Instances**
Depending on the license, this may be the number of ports enabled or number of simultaneous users of the licensed feature. Sometime the number of instances is specified in the license name.
- **Expires**
Most purchased licenses have no expiry setting. For some features, trial licenses may be available which will have an expiry date.



8.12.1 System Edition Licenses

These license are used to set what range of features the IP Office system supports. 📄 Essential Edition Additional Voicemail Ports : 📄 *IPO LIC R6 ESSNTL EDDITION ADD 2 - 229423*.

For IP500v2 only. Unlicensed, the embedded voicemail provided by the system supports 2 simultaneous connections and 15 hours of storage. This can be expanded up to 6 channels by the addition of licenses, each of which enables an additional two channels. For IP Office Release7.0+ each license also enables an additional 5 hours of storage.

Upgrade Licenses

Existing IP Office systems being upgraded to IP Office Release 6.0 or higher may require a software upgrade license.









- **New IP500v2 Systems**
For the first 90 days, a new IP500v2 control unit will run any supported IP Office Release without requiring an upgrade license. The highest level run is written into the system's memory (not the SD card) and that becomes a permanent entitlement for the control unit. However, after 90 days the IP500v2 will require an upgrade license if upgraded to a software release higher than any that it has run in the initial 90 day period.
-  **Warning**
Systems upgraded without the appropriate license will display *"No license available"* and will not allow any telephony functions.
-  **Software Upgrade**
Existing IP Office systems being upgraded to IP Office Release 6.0 or higher require an upgrade license. This applies to all IP Office system modes, for example IP Office standard mode, IP Office Standard Version, IP Office Essential Edition - PARTNER® Version, IP Office Essential Edition - Norstar Version and IP Office Essential Edition - Quick Version modes. There are two types of upgrade licenses as follows:
 - **Small System Upgrade Licenses:** 📄 *IPO LIC UPG R7.0 SML - 262645*.
This license can be used to upgrade systems with up to 32 users and no external expansion modules.
 - **Large System Upgrade Licenses:** 📄 *IPO LIC UPG R7.0 - 262644*.
This license can be used to upgrade system with more than 32 users or with external expansion modules.

8.12.2 Trunk Licensing

The following trunks licenses can be used by a IP Office Essential Edition - Quick Version mode system.

-  IP500 Universal PRI (Additional channels)

These licenses are used to enable additional B-channels above the basic 8 on an IP500 PRI-U card. The IP500 PRI-U card supports E1, T1 and E1-R2 PRI modes. The IP Office system supports 8 unlicensed B-channels on each IP500 PRI-U port fitted. Additional B-channels, up to the capacity of ports installed and PRI mode selected require licenses. These additional channels consume the licenses based on which additional channels are configured as in-service from port 9 of slot 1 upwards. D-channels are not affected by licensing.

-  *IP500 T1 CHANNELS ADD 2CH - 215180.*
-  *IP500 T1 CHANNELS ADD 8CH - 215181.*
-  *IP500 T1 CHANNELS ADD 32CH - 215182.*
-  *IP500 E1 CHANNELS ADD 2CH - 215183.*
-  *IP500 E1 CHANNELS ADD 8CH - 215184.*
-  *IP500 E1 CHANNELS ADD 22CH - 215185.*
-  *IP500 E1R2 CHANNELS ADD 2CH - 215186.*
-  *IP500 E1R2 CHANNELS ADD 8CH - 215187.*
-  *IP500 E1R2 CHANNELS ADD 22CH - 215188.*

-  SIP Trunk Channels





These licenses are used to configure the maximum number of simultaneous SIP trunk calls supported. A IP Office Essential Edition - Quick Version mode system supports 3 channels without licenses.

-  *IPO LIC SIP TRNK RFA 1 - 202967.*
-  *IPO LIC SIP TRNK RFA 5 - 202968.*
-  *IPO LIC SIP TRNK RFA 10 - 202969.*
-  *IPO LIC SIP TRNK RFA 20 - 202970.*

8.12.3 User Licenses

- Mobile Worker Profile License

By default only 3 users can be configured to use remote forwarding/mobile twinning features. Additional users can be enabled by the addition of Mobile Worker licenses to the configuration.

-  *IPO LIC R6 MOBILE WORKER 1 - 229434.*
-  *IPO LIC R6 MOBILE WORKER 5 - 229435.*
-  *IPO LIC R6 MOBILE WORKER 20 - 229436.*
-  *IPO LIC R6 MOBILE WORKER 5 TRIAL - 229437.*

8.12.4 Trial Licenses

The following trial licenses can be requested. A trial license is valid for 60 days from the date of issue and can only be issued once for a particular IP Office Feature Key serial number. Apart from those restrictions, the trial license works the same as a full license.

- Mobile Worker (5 Users): 📄 *IPO LIC R6 MOBILE WORKER 5 TRIAL - 229437.*



Chapter 9.

Safety Statements

9. Safety Statements

The Avaya IP400 Office and IP500 Office modules are intended to be installed by 'Service Personnel' and it is the responsibility of the Service Personnel to ensure that all subsidiary interconnected equipment is wired correctly and also meet the safety requirements of IEC60950 or UL60950 where applicable.

. CE

The CE mark affixed to this equipment means that the module complies with the 1999/5/EC (R&TTE), 89/336/EEC (EMC) and 72/23EEC (LVD) Directives.

- The Declarations of Conformity (DoC) for the IP400 and IP500 products are available on the IP Office Application DVD.
-  This warning symbol is found on the base of IP500 modules.
- Refer to [Trunk Interface Modules](#)^[217] for information concerning which Trunk Interface module variants are fitted in which country.

In Finland, Norway and Sweden a protective earthing conductor must be attached to the protective earth point on the rear of the IPO500 and IPO500v2 Servers. See [Grounding](#)^[73] for more information. In addition the Server must be located in a restricted access location where equipotential bonding has been applied, for example, in a telecommunication centre.

9.1 Lithium Batteries

A lithium battery is fitted to the real time clock on IP Office IP400 control unit motherboards and the IP500 control unit motherboard. .

WARNING

The Lithium battery must only be replaced by Avaya personnel or authorized representatives. There is a danger of explosion if the battery is incorrectly replaced. Replace only with the same or equivalent type recommended by the manufacturer. Dispose of used batteries according to the manufacturer's instructions.

9.2 Lightning Protection/Hazard Symbols

Lightning protectors

The buildings lightning protectors must be verified as follow:

1. Check the lightning protectors, at the trunk cable entry point to the building housing the Avaya IP Office, paying special attention to the lightning protection grounding. Report any problems, in writing, to the telephone company.
2. Equipment that is designed to be connected using internal wiring is typically not lightning protected. Hence, Avaya IP Office extension cabling must not leave the building. For installations where telephones and/or other standard (tip/ring) devices are installed in another building then lightning protection is required (see [Out of Building Telephone Installations](#)^[26]).



Hazard Symbol

The shock hazard symbol is intended to alert personnel to electrical hazard or equipment damage. The following precautions must also be observed when installing telephone equipment:

1. Never install telephone wiring during a lightning storm.
2. Never install telephone jacks in wet locations unless the jack is specifically designed for wet locations.
3. Never touch uninsulated telephone wires or terminals unless the telephone line has been disconnected at the network interface.
4. Always use caution when working with telephone lines.

9.3 Trunk Interface Modules

To ensure the validation of the approvals, only the following types of trunk interface cards must be fitted in the following IP Office control units.

USA/Canada						
Product	Quad BRI	PRI E1		PRI T1		ATM4
		Single	Dual	Single	Dual	
IP500v2	✗	✗	✗	✓	✓	✓
IP500	✗	✗	✗	✓	✓	✓

Rest of World						
Product	Quad BRI	PRI E1/E1R2		PRI T1		ATM4
		Single	Dual	Single	Dual	
IP500v2	✓	✓	✓	✗	✗	✓
IP500	✓	✓	✓	✗	✗	✓

Notes

- E1R2 trunks are only supported in CALA and Korea.

9.4 Further Information and Product Updates

Further information, including Product and Reference Manual updates, can be obtained from Avaya Dealers and Distributors or from Avaya's web site: <http://www.avaya.com>.

This guide is also available from the Avaya's support web site: <http://support.avaya.com>.

Support Telephone Numbers

For initial help and support, contact your distributor/supplier. The following contact points are for Avaya authorized partners.

- In the USA only
Avaya provides a toll-free Customer Helpline 24 hours a day:
 - Name: Avaya Technical Support Organization (TSO)
 - Customer Helpline: 1 800 628-2888
 - Address: 8744 Lucent Blvd., Highlands Ranch, Colorado, 80129 USA
 - URL: <http://support.avaya.com>
If you need assistance when installing, programming, or using your system, call the Helpline or your Avaya representative. Consultation charges may apply.
- Outside the USA
If you need assistance when installing, programming, or using your system, contact your Avaya representative.
 - URL: <http://support.avaya.com>

9.5 Port Safety Classification

The Avaya IP Office systems have the following ports which are classified as follows:

Port Name	Port Description	Port Classification
PRI port	PRI ISDN connection (NET)	TNV (Operating within the limits of SELV)
BRI ports	BRI ISDN connection (NET)	TNV (Operating within the limits of SELV)
Analog ports	Two wire analog trunk	TNV3
Power fail ports	Two wire analog trunk	TNV3
DTE port	Async Data connection.	SELV
Analog Telephone Ports	Telephone Extension ports	TNV2
Digital Telephone Ports	Telephone Extension ports	SELV
LAN ports	10/100 BaseT attachment to LAN.	SELV
Expansion ports	Expansion Module connector.	SELV
Audio port	Connector for Music on Hold.	SELV
External Control port	Connector for Controlling Ancillary circuits.	SELV
DC Input port	Connector for DC input power.	SELV

Interconnection circuits shall be selected to provide continued conformance with the requirements of EN 609050:1992/A3:1995 clause 2.3 for SELV circuits and with the requirements of clause 6 for TNV circuits, after connections between equipment.

9.6 EMC Directive

889/336/ EEC (EMC Directive) CISPR 22:1993 including A1 + A2, AS/NZ 3548:1995 (ROW)

-  WARNING
This is a class A product. In a domestic environment this product may cause radio interference in which case the user may be required to take adequate measures.

Federal Communications Commission (FCC)

This equipment has been tested and found to comply with the limits for a Class A digital device, pursuant to Part 15 of the FCC Rules. These limits are designed to provide reasonable protection against harmful interference when the equipment is operated in a commercial environment. This equipment generates, uses, and can radiate radio frequency energy and, if not installed and used in accordance with the instruction manual, may cause harmful interference to radio communications. Operation of this equipment in a residential area is likely to cause harmful interference, in which case the user will be required to correct the interference at his or her own expense.

Canadian Department of Communications (DOC)

"NOTICE: This equipment meets the applicable Industry Canada Terminal Equipment Technical Specifications. This is confirmed by the registration number. The abbreviation, IC, before the registration number signifies that registration was performed based on a Declaration of Conformity indicating that Industry Canada technical specifications were met. It does not imply that Industry Canada approved the equipment."

EMC Caution for China

警示

注意：此为A级产品，在生活环境中，该产品可能会造成无线电干扰。在这种情况下，可能需要用户对其干扰采取切实可行的措施。仅适用于商业或工业环境。

9.7 Regulatory Instructions for Use

9.7.1 Australia

Connection

Connection of IP400 Office products must be via a Line Isolation Module with a telecommunications compliance label.

BRI Interface

During the configuration, ensure "000" emergency number is not barred, by performing the following:

- Short Code: 000
- Telephone No: 000;
- Function: DialEmergency

Connections to TS013, the following Bearer Capabilities shall not be used:

- 7kHz Audio, Video, Restricted Digital Information.

If unknown type of number is used in calling party number, the network will use the default CLI.

The system must be configured for Point to Multi point connection to comply with Austel requirements for connecting to TS013 circuits.

As the IP Office does not support emergency dialing after loss of power, the following warning notice should be recognized:

- **WARNING**
This equipment will be inoperable when mains power fails.

PRI Interface

During the configuration, ensure "000" emergency number is not barred, by performing the following:

- Short Code: 000
- Telephone No: 000;
- Function: DialEmergency

- **WARNING**
This equipment will be inoperable during mains power failure.

9.7.2 Canada

This equipment meets the applicable Industry Canada Terminal Equipment Technical Specifications. This is confirmed by the registration number. The abbreviation, IC, before the registration number signifies that registration was performed based on a Declaration of Conformity indicating that Industry Canada technical specifications were met.

It does not imply that Industry Canada approved the equipment.

"NOTICE: The Ringer Equivalence Number (REN) for this terminal equipment is 1. The REN assigned to each terminal equipment provides an indication of the maximum number of terminals allowed to be connected to a telephone interface. The termination on an interface may consist of any combination of devices subject only to the requirement that the sum of the Ringer Equivalence Numbers of all the devices does not exceed five."

9.7.3 China



700433220

February 2007

Copyright© 2007, Avaya Inc. All Rights Reserved

所有在中华人民共和国境内进口或销售的电子信息产品必须附上本文件
Include this document with all Electronic Information Products imported or sold in the People's Republic of China

部件名称 (Part Name)	有毒有害物质或元素 (Hazardous Substance)					
	铅 (Pb)	汞 (Hg)	镉 (Cd)	六价铬 (Cr ⁶⁺)	多溴联苯 (PBB)	多溴二苯醚 (PBDE)
金属部件 (Metal Parts)	×	○	○	○	○	○
电路模块 (Circuit Modules)	×	○	○	○	○	○
电缆及电缆组件 (Cables & Cable Assemblies)	×	○	○	○	○	○
塑料和聚合物部件 (Plastic and Polymeric parts)	○	○	○	○	○	○
电路开关/断路器 (Circuit Switch/Breakers)	○	○	○	○	○	○
电源组件 (Power Assemblies)	×	○	○	○	○	○
显示器 (LCD, Monitor)	○	○	○	○	○	○
玻璃 (Glass)	○	○	○	○	○	○

○：表示该有毒有害物质在该部件所有均质材料中的含量均在 SJ/T 11363 2006 标准规定的限量要求以下。
 Indicates that the concentration of the hazardous substance in all homogeneous materials in the parts is below the relevant threshold of the SJ/T 11363 2006 standard.

×：表示该有毒有害物质至少在该部件的某一均质材料中的含量超出 SJ/T 11363 2006 标准规定的限量要求。
 Indicates that the concentration of the hazardous substance of at least one of all homogeneous materials in the parts is above the relevant threshold of the SJ/T 11363 2006 standard.

本表显示，所附的亚美亚电子信息产品中，从生产日期起，可能包含这些物质。注意：所附产品可能包含或不包含以上所列的某些组件。

This table shows where these substances may be found in Avaya's electronic information products, as of the date of manufacture of the enclosed product. Note that some of the component types listed above may or may not be a part of the enclosed product.

除非有另外特别的标注,此标志将作为所附产品及零部件的环保使用期标志。某些产品会有一个不同的环保使用期(例如,电话机)并贴在其产品上。此环保使用期限只适用于产品在产品手册中所规定的条件下使用



The Environmentally Friendly Use Period (EFUP) for all enclosed products and their parts are per the symbol shown here, unless otherwise marked. Certain products have a different EFUP (for example, telephones) and so are marked to reflect such. The Environmentally Friendly Use Period is valid only when the product is operated under the conditions defined in the product manual.

9.7.4 European Union

1. 999 and 112 calls must not be barred. Doing so will invalidate the approval.
2. All connections at the MDF shall be identifiable by suitable labeling.
3. The CE mark displayed on IP Office equipment indicates the systems compliance with the EMC, LVD, and R&TTE Directives and common technical regulations for Primary Rate and Basic Rate ISDN.
4. All ports for the connection of other non-telecommunications apparatus have a Safety Extra Low Voltage (SELV) safety status.

9.7.5 New Zealand

The grant of a Telepermit for any item of terminal equipment indicates only that Telecom has accepted that the item complies with minimum conditions for connection to its network. It indicates no endorsement of the product by Telecom, nor does it provide any sort of warranty. Above all, it provides no assurance that any item will work correctly in all respects with another item of Telepermitted equipment of a different make or model, nor does it imply that any product is compatible with all of Telecom's network services.

9.7.6 FCC Notification

This equipment complies with Part 68 of the FCC rules and the requirements adopted by the Administrative Council on Terminal Attachments (ACTA). On the rear of this equipment is a label that contains, among other information, a product identifier in the format US:AAAEQ##TXXX. If requested, this number must be provided to the telephone company.

The REN is used to determine the quantity of devices that may be connected to the telephone line. Excessive RENs on the telephone line may result in devices not ringing in response to an incoming call. In most, but not all areas, the sum of RENs should not exceed 5.0. To be certain of the number of devices that may be connected to a line, as determined by the total RENs, contact the local telephone company. For products approved after July 23, 2001, the REN for this product is part of the product identifier that has the format US:AAAEQ##TXXX. The digits represented by ## are the REN without a decimal point (for example, 03 is a REN of 0.3). For earlier products, the REN is separately shown on the label.

Means of Connection

Connection of this equipment to the telephone network is shown in the following table.

Port	FIC	SOC	USOC Jack	REN
IPO500 PRI 1U, IPO500 PRI2U, IP400 PRI-T1	04DU9.BN, 04DU9.DN, 04DU9.IKN, 04DU9.ISN	6.0Y	RJ48C	NA
IPO500 ATM4U IP400 ATM4U	OL13A, OL13B, OL13C, 02AC2, 02LA2, 02LB2, 02LC2, 02LR2, 02LS2	9.0Y	RJ45S	0.1B
IPO500 ATM16	OL13A, OL13B, OL13C, 02AC2, 02GS2, 02LA2, 02LB2, 02LC2, 02LR2, 02LF2 02GS2, 02LS2	9.0Y	RJ45S	0.1B

If this equipment causes harm to the telephone network, the telephone company will notify you in advance that temporary discontinuance of service may be required. But if advance notice is not practical, the telephone company will notify the customer as soon as possible. Also, you will be advised of your right to file a complaint with the FCC if you believe it is necessary.

The telephone company may make changes in its facilities, equipment, operations or procedures that could affect the operation of the equipment. If this happens, the telephone company will provide advance notice in order for you to make necessary modifications to maintain uninterrupted service.

If trouble is experienced with this equipment, for repair or warranty information, please contact the Technical Service Center at 1-800-242- 2121 or contact your local Avaya representative. If the equipment is causing harm to the telephone network, the telephone company may request that you disconnect the equipment until the problem is resolved.

A plug and jack used to connect this equipment to the premises wiring and telephone network must comply with the applicable FCC Part 68 rules and requirements adopted by the ACTA.

Connection to party line service is subject to state tariffs. Contact the state public utility commission, public service commission or corporation commission for information.

Equipment With Direct Inward Dialing (“DID”):

Allowing this equipment to be operated in such a manner as to not provide proper answer supervision is a violation of Part 68 of the FCC’s rules.

Proper Answer Supervision is when:

- A. This equipment returns answer supervision to the public switched telephone network (PSTN) when DID calls are:
 - answered by the called station,
 - answered by the attendant,
 - routed to a recorded announcement that can be administered by the customer premises equipment (CPE) user.
 - Routed to a dial prompt
- B. This equipment returns answer supervision signals on all (DID) calls forwarded back to the PSTN.
Permissible exceptions are:
 - A call is unanswered.
 - A busy tone is received.
 - A reorder tone is received.

Avaya attests that this registered equipment is capable of providing users access to interstate providers of operator services through the use of access codes. Modification of this equipment by call aggregators to block access dialing codes is a violation of the Telephone Operator Consumers Act of 1990.

Automatic Dialers:

When programming emergency numbers and (or) making test calls to emergency numbers:

1. Remain on the line and briefly explain to the dispatcher the reason for the call.
2. Perform such activities in the off-peak hours, such as early morning or late evenings.

Toll Restriction and Least Cost Routing Equipment:

The software contained in this equipment to allow user access to the network must be upgraded to recognize newly established network area codes and exchange codes as they are placed into service.

Failure to upgrade the premises systems or peripheral equipment to recognize the new codes as they are established will restrict the customer and the customer’s employees from gaining access to the network and to these codes.

FCC Part 68 Supplier’s Declarations of Conformity

Avaya Inc. in the United States of America hereby certifies that the equipment described in this document and bearing a TIA TSB-168 label identification number complies with the FCC’s Rules and Regulations 47 CFR Part 68, and the Administrative Council on Terminal Attachments (ACTA) adopted technical criteria.

Avaya further asserts that Avaya handset-equipped terminal equipment described in this document complies with Paragraph 68.316 of the FCC Rules and Regulations defining Hearing Aid Compatibility and is deemed compatible with hearing aids.

9.7.7 Compliance with FCC Rules

Transmit and Receive Gain Settings for PRI /T1 and Analog Ports

The Gain settings are password controlled for use by qualified installation personnel only and must not be made available to the end user. The default gain settings of 0dB ensures compliance with FCC part 68 section 68.308(b)(5) and TIA/EIA-IS-968 Section 4.5.2.5. "Through transmission amplification from ports for the connection of separately registered equipment or from other network connection ports". Gain setting adjustment by unqualified personnel may result in violation of the FCC rules. Qualified personnel may adjust gain settings above these levels only where:

1. Measurement is made to ensure that the power levels sent to line at each network interface connected does not exceed the maximum levels specified in FCC part 68 section 68.308(b) and TIA/EIA-IS-968 Section 4.5 for that specific interface type.
2. Where gain adjustment away from the default values are made, precautions should be taken to ensure that the connection of terminal equipment is controlled by qualified installation personnel.
3. To conform with the Receive Objective Loudness Rating at distances greater than 2.7km from the central office, on analog trunks a receive gain of 1.5dB must be set.

Index

A

- Analog
 - Phone Barrier Boxes 103
 - Phone Region Availability 30, 163
 - Port 195, 198
- Application
 - Call Logging 33
 - CD/DVD 33
 - Maintenance 33
 - Manager 188
 - Monitor 189
 - System Status Application 190
 - TAPI 191
 - User 33
 - Voicemail 33
- Audio
 - Port 195
- Audio Port 198
- Availability of Equipment 7

B

- Backup
 - SD Card 121
- Barrier Boxes
 - Analog Phone 103
 - Rack Mounting 104
- Base Card
 - Analog Phone 15, 137
 - Digital Station 15, 137
 - Legacy Card Carrier 15, 137
 - VCM 15, 137
- Batteries
 - Lithium 216
- BRI
 - (Trunk) Port 199
 - Port 195
- Buttons
 - Call appearance 82
 - Intercom 82
 - Line appearance 82
 - Programmable 82

C

- Cable
 - Access Requirements 39
 - Clearance Requirements 39
- Cables
 - Maximum Cable Distances 23, 196
 - Standard IP Office 23, 196
- Cabling
 - Lightening Protection 26, 101
- Call appearance buttons 82
- Call Logging Application 33
- Call Status
 - Application 33
- Calls
 - External 82
 - Internal 82
- Cards
 - IP500 Analog Phone Base 139
 - IP500 Digital Station Base 142
- Conference Center
 - Application 33
- Configuration
 - Create New 60

- Erase 108
 - Connections
 - Grounding 25
 - Out of Building 26, 101
 - ContactStore
 - Application 33
 - Control Unit
 - Rack Mounting 27
 - Wall Mounting 27
 - Copy
 - SD Card 123
 - Country
 - Languages 32
 - Supported Locales 32
 - Create Configuration 60
- ## D
- Daughter Cards
 - Analog Trunk 17, 146
 - BRI Trunk 17, 147
 - PRI Trunk 148
 - PRI-U Trunk 17
 - Trunk 17
 - DC I/P
 - Port 195
 - DCI I/P Port 200
 - DECT
 - Phone 30, 163
 - Region Availability 30, 163
 - DS
 - IROB 102
 - Phone 30, 102, 163
 - Port 195, 200
 - Region Availability 30, 163
 - DTE Port 107
 - Cable requirement 107, 201
 - RS232 107, 201
 - Settings 107, 201
- ## E
- Embedded Voicemail
 - Application 33
 - EMC Cautions
 - Canadian Department of Communications 219
 - EMC Caution for China 219
 - Federal Communications Commission 219
 - Envirmental Requirements 38
 - Equipment Availability 7
 - Expansion
 - Port 195
 - Expansion Modules
 - IP400 Analog Trunk 18
 - IP400 Digital Station 18
 - IP400 Phone 18
 - IP400 So8 18
 - IP400 WAN3 18
 - IP500 Analog Trunk 16 150
 - IP500 Digital Station 18, 152
 - IP500 Phone 18, 157
 - IPO 500 Analog Trunk 18
 - IPO 500 BRI So8 18
 - Expansion Port 203
 - EXT O/P
 - Port 195
 - EXT O/P Port 105, 203
 - External calls 82
 - External Expansion Modules 18

F

- Faulty Units 7
- FCC Rules 225
- Feature Key Server
 - Application 33
- Feature Keys
 - Parallel 29
 - Serial 29
 - Smart Card 29
 - USB 29
- Firewall Exceptioning 192

G

- General Information
 - Training Courses 35
 - Web Sites 35
- Grounding Control Units 25

H

- H323
 - Phones 30, 163
 - Region Availability 30, 163
- Hazard Symbols 216
- Hazardous Substances 7
- Homologation Statement 216

I

- Intercom buttons 82
- Internal calls 82
- IP Office Operation in
 - Australia 220
 - Canada 220
 - China 221
 - European Union 222
 - New Zealand 222
 - USA 223
- IP500
 - Analog Phone Base Card 15, 137
 - Analog Trunk Daughter Card 17
 - BRI Trunk Daughter Card 17
 - Digital Station Base Card 15, 137
 - Legacy Card Carrier Base Card 15, 137
 - PRI-U Trunk Daughter Card 17
 - Reset Button 106
 - Trunk Daughter Card 17
 - VCM Base Card 15, 137
- IP500 Installation
 - Admin Applications 47
 - Card 62
 - Check Card LED 76
 - Connect Manager 49
 - Documentation 56
 - Grounding 73
 - Rack Mounting 69
 - Start Manager 50
 - Tools 55
 - Unpacking 57

K

- Key Mode 82

L

- LAN
 - Port 195
- LAN Port 204
- Licences
 - Manager 188
 - Monitor 189
 - System Status Application 190

TAPI 191

Licences

- PC-Base 29
- PC-Less 29
- Lightening Portection 216
- Lightening Protection 26, 101
- Line appearance buttons 82
- Lithium Batteries 216

M

- Maintenance
 - Applications 33
- Manager
 - Application 33
 - Components 188
 - License Requirements 188
 - PC Requirements 188
 - Upgrade Software 97

Memory card

- Removal 93, 114, 129

Mode

- Key 82
- PBX 82

Modules

- Trunk Interface 217

Monitor

- Application 33
- Components 189
- License Requirements 189
- PC Requirements 189
- Protocols 192

MS-CRM

- Application 33

N

- New Configuration 60

O**Out of Building**

- Connections 26, 101

P

- Parallel Feature Key 29
- PBX Mode 82
- PC-Base Licensing 29
- PC-Less Licensing 29
- PF

- Port 195

PF Port 205**Phone (POT)**

- Port 195

Phone (POT) Port 206**Phone Manager**

- Application 33

Port

- Analog 195, 198
- Assigned 192
- Audio 195, 198
- BRI 195
- BRI (Trunk) 199
- DC I/P 195
- DCI I/P 200
- Door 105
- DS 195, 200
- Expansion 195, 203
- EXT O/P 105, 195, 203
- IP Office 192
- LAN 195, 204
- PF 195, 205

- Port
 - Phone (POT) 195, 206
 - PRI 195, 207
 - RS232/DTE 195
 - RS323 DTE 107, 201
 - Safety Classification 218
 - USB 195
 - Used 192
 - WAN 195
- Power Supplies
 - 1151C1 20
 - 1151C2 20
 - Cords 21
 - Type 40w PSU 20
 - Type 45W Earthed PSU 20
 - Type 60W Earthed PSU 20
 - Uninterrupted Power Supply 22
- PRI
 - Port 195
- PRI Port 207
- Programmable buttons 82
- Protocols 192
- R**
- Rack Mounting Control Units 27
- Region Availability
 - Analog Phone 30, 163
 - DECT Phone 30, 163
 - DS Phone 30, 163
 - H323 Phone 30, 163
- Remove
 - SD Card 93, 114, 129
- Requirements
 - Cable Access 39
 - Cable Clearance 39
 - Enviromental 38
 - Space 39
 - Wall Mounting 38
- Restore
 - SD Card 122
- RoHS 7
- RS232/DTE
 - Port 195
- S**
- Safety Statement 216
- SD Card
 - Backup 121
 - Copy 123
 - Removal 93, 114, 129
 - Restore 122
- Security Settings
 - Default 110
- Serial Feature Key 29
- Smart card Feature Key 29
- SNMP MIBs
 - Application 33
- SoftConsole
 - Application 33
- Software
 - Erase Core Software 111
- Space Requirements 39
- Statement
 - Homologation 216
 - Safety 216
- Supported
 - Language 32
 - Locales 32
- System Status
 - Application 33
- System Status Application
 - Components 190
 - License Requirements 190
 - PC Requirements 190
- T**
- TAPI
 - Components 191
 - License Requirements 191
 - PC Requirements 191
- TAPILink Lite
 - Application 33
- Training Courses 35
- Trunk Interface Modules 217
- U**
- USB
 - Feature Key 29
 - Port 195
- V**
- Voicemail Lite
 - Application 33
- VoiceMail Pro
 - Application 33
- W**
- Wall Mounting Control Units 27
- Wall Mounting Requirements 38
- WAN
 - Port 195
- Web Sites 35

Performance figures and data quoted in this document are typical, and must be specifically confirmed in writing by Avaya before they become applicable to any particular order or contract. The company reserves the right to make alterations or amendments to the detailed specifications at its discretion. The publication of information in this document does not imply freedom from patent or other protective rights of Avaya or others.

All trademarks identified by the ® or ™ are registered trademarks or trademarks, respectively, of Avaya Inc. All other trademarks are the property of their respective owners.

This document contains proprietary information of Avaya and is not to be disclosed or used except in accordance with applicable agreements.

© 2011 Avaya Inc. All rights reserved.